



भारत सरकार  
Government of India  
विद्युत मंत्रालय  
Ministry of Power  
उत्तर क्षेत्रीय विद्युत समिति  
Northern Regional Power Committee

सेवा में : संरक्षण उप-समिति के सदस्य (सूची के अनुसार) ।

To: Members of Protection Sub-Committee (As per mail list)

विषय: संरक्षण उप-समिति की 55 वीं बैठक की कार्यसूची ।

Subject: Agenda for 55<sup>th</sup> Protection Sub-Committee Meeting.

संरक्षण उप-समिति की 55 वीं बैठक, दिनांक 20.12.2024 को 10:30 बजे को एनआरपीसी सचिवालय, कटवारिया सराय, नई दिल्ली में होने वाली है। उक्त बैठक की कार्यसूची संलग्न है। यह उत्तर क्षेत्रीय विद्युत् समिति की वेबसाइट (<http://164.100.60.165/>) पर भी उपलब्ध है। कृपया बैठक में उपस्थिति सुनिश्चित करें।

The 55<sup>th</sup> meeting of Protection Sub-Committee is scheduled to be held on 20.12.2024 (10:30 AM) at NRPC Secretariat, Katwaria Sarai, New Delhi. The agenda for the meeting is attached herewith. The same is also available on NRPC website (<http://164.100.60.165/>). Kindly make it convenient to attend the same.

Signed by Dharmendra  
Kumar Meena

Date: 14-12-2024 07:37:28  
डॉ. क. मीना

निदेशक (संरक्षण)

## **Agenda of 55<sup>th</sup> Protection Sub-Committee Meeting (20<sup>th</sup> December, 2024)**

### **Contents**

Part-A: NRPC.....	4
A.1. Confirmation of minutes of 54 <sup>th</sup> meeting of Protection Sub-Committee.....	4
A.2. Status of action taken on decisions of 54 <sup>th</sup> Protection Sub-Committee meeting (agenda NRPC Secretariat).....	4
A.3. Submission of protection performance indices along with reason and corrective action taken for indices less than unity to NRPC Secretariat on monthly basis (agenda by NRPC Secretariat).....	4
A.4. Annual protection audit plan for FY 2024-25 and third-party protection audit plan (agenda by NRPC Secretariat).....	6
A.5. Annual protection audit plan for FY 2025-26 (agenda by NRPC Secretariat).....	7
A.6. Observations and Compliance of recommendations of protection audit (agenda by NRPC Secretariat).....	7
A.7. Provisional protection clearance during FTC in October 2024 (agenda by NRPC Secretariat).....	8
A.8. Tripping of every transmission line whenever Broken Conductor Alarm on 220kV feeder and loss of VT (in any of phase) at 220kV bus is observed simultaneously (agenda by RVPN).....	9
A.9. Tripping of line reactors due to ferro-resonance (agenda by POWERGRID).....	10
A.10. Frequent faults in 220kV downstream feeders and need for review of Auto- Reclosure settings in these 220kV lines (agenda by POWERGRID).....	11
A.11. Review of Zone-2 & Zone-3 time delay settings at Mandola (PG) substation for 220kV Mandola (PG)-Gopalpur (DTL) lines (agenda by POWERGRID).....	12
A.12. Review of Zone-2 & Zone-3 time delay settings at Sonipat (PG) substation for 220kV Sonipat (PG)-Mohana (HVPNL) lines (agenda by POWERGRID).....	13
A.13. Tripping of Rihand Stage-3 Units, during Monopole Ground Return Mode Operation of Rihand Dadri HVDC line (agenda by NTPC).....	14
A.14. Centralized Database for Protection Settings in Northern Region to be implemented under PSDF (agenda by NRPC Secretariat).....	15
A.15. Use of line VT/CVT for Main-1 and Bus VT/CVT for Main-2 Distance Protection Scheme on 220kV lines (agenda by RVPN).....	16
Part-B: NRLDC.....	17
B.1 Status of remedial actions recommended during previous PSC meetings (agenda by NRLDC).....	17
B.2 Multiple elements tripping events in Northern region in the month of November'24 (agenda by NRLDC).....	17
B.3 Analysis of the tripping events occurred during November-2024 and status of remedial action taken (agenda by NRLDC).....	18
B.4 Details of tripping of Inter-Regional lines from Northern Region for November' 24 (agenda by NRLDC).....	20
B.5 Status of Bus bar protection (agenda by NRLDC).....	20

**Agenda of 55<sup>th</sup> Protection Sub-Committee Meeting (20<sup>th</sup> December, 2024)**

B.6	Replacement of electromechanical relays with numerical relays (agenda by NRLDC)	21
B.7	Availability and Standardization of recording instrument (Disturbance recorder and Station Event Logger) and status of work regarding undertaking submitted during First Time Charging of elements (agenda by NRLDC).....	22
B.8	Corrective action for healthiness of 500kV Mundra-Mahindergarh SPS (agenda by NRLDC).....	23
Part C: Final Protection Settings Approval by PSC Forum for FTCs which have been provisionally allowed by NRLDC/SLDCs.....		25
C.1.	Approval of protection settings in compliance of IEGC 2023 (agenda by AGEL).....	25
C.2.	Approval of protection settings in compliance of IEGC 2023 (agenda by Rajasthan SLDC).....	25
C.3.	Approval of protection settings in compliance of IEGC 2023 (agenda by HVPNL).....	26
C.4.	Post-facto Approval of Transmission Line Protection Scheme for LILO of one ckt of 220kV Sector-72 (PG) – Sector-72 (HVPN) Gurugram at 220kV substation Sector-15 HVPN Gurugram (agenda by HVPNL).....	27
C.5.	Approval of protection settings in compliance of IEGC 2023 (agenda by POWERGRID).....	28

*Agenda of 55<sup>th</sup> Protection Sub-Committee Meeting (20<sup>th</sup> December, 2024)*

---

**Agenda for**  
**55<sup>th</sup> Meeting of Protection Sub-Committee (PSC) of**  
**Northern Regional Power Committee**

---

**Date and time of meeting** : 20.12.2024 10.30 Hrs.

**Venue** : NRPC Secretariat, New Delhi

**Part-A: NRPC**

**A.1. Confirmation of minutes of 54<sup>th</sup> meeting of Protection Sub-Committee**

A.1.1 54<sup>th</sup> PSC meeting was held on 25.11.2024. Minutes of the meeting were issued vide letter dt. 06.12.2024. No comment has been received till the date.

**Decision required from Forum:**

*Forum may approve the minutes of 54<sup>th</sup> PSC meeting.*

**A.2. Status of action taken on decisions of 54<sup>th</sup> Protection Sub-Committee meeting (agenda NRPC Secretariat)**

A.2.1 Status on decisions of 54<sup>th</sup> NRPC meeting is attached as **Annexure-A.I.**

**Decision required from Forum:**

*Status of action taken may be discussed in meeting.*

**A.3. Submission of protection performance indices along with reason and corrective action taken for indices less than unity to NRPC Secretariat on monthly basis (agenda by NRPC Secretariat)**

A.3.1 As per clause 15 (6) of IEGC 2023;

- *Users shall submit the following protection performance indices of previous month to their respective RPC and RLDC on monthly basis for 220 kV and above (132 kV and above in NER) system, which shall be reviewed by the RPC:*



**Agenda of 55<sup>th</sup> Protection Sub-Committee Meeting (20<sup>th</sup> December, 2024)**

a) The **Dependability Index** defined as  $D = Nc / Nc + Nf$

b) The **Security Index** defined as  $S = Nc / Nc + Nu$

c) The **Reliability Index** defined as  $R = Nc / Nc + Ni$

where,

$Nc$  is the number of correct operations at internal power system faults,

$Nf$  is the number of failures to operate at internal power system faults,

$Nu$  is the number of unwanted operations,

$Ni$  is the number of incorrect operations and is the sum of  $Nf$  and  $Nu$

Further, as per clause 15 (7) of IEGC 2023;

- Each user shall also submit the reasons for performance indices less than unity of individual element wise protection system to the respective RPC and action plan for corrective measures. The action plan will be followed up regularly in the respective RPC.

A.3.2 In earlier PSC meeting, it was decided that each utility shall submit the Performance indices of previous month by 7<sup>th</sup> day of next month.

A.3.3 Accordingly, the status of the indices reported for the month of November-2024 is attached as **Annexure- A.II**.

A.3.4 Further, based on submitted data by the utilities as on date, the summary of events of November-2024 that caused indices less than unity is also attached as **Annexure- A.III**. Most of the concerned utilities have submitted the reason for the same and corrective action taken to resolve the related issue. However, who have not submitted, may send at the earliest.

A.3.5 Further, it is requested that utilities may submit the performance indices of previous month by 7<sup>th</sup> day of next month element wise along with the reason for indices less than unity and corrective action taken.

**Decision required from Forum:**

**Agenda of 55<sup>th</sup> Protection Sub-Committee Meeting (20<sup>th</sup> December, 2024)**

*Members may deliberate on delay from utilities in submission of indices, and action taken in cases where indices are less than one.*

**A.4. Annual protection audit plan for FY 2024-25 and third-party protection audit plan (agenda by NRPC Secretariat)**

**Annual Internal Audit Plan:**

A.4.1 As per clause 15 of IEGC 2023;

- *Annual audit plan for the next financial year shall be submitted by the users to their respective RPC by 31st October. The users shall adhere to the annual audit plan and report compliance of the same to their respective RPC.*

A.4.2 In the 48<sup>th</sup>, 49<sup>th</sup>, 50<sup>th</sup>, 51<sup>st</sup>, 52<sup>nd</sup>, 53<sup>rd</sup> & 54<sup>th</sup> PSC meetings, all utilities were requested to submit the annual protection audit plan.

A.4.3 Some utilities have submitted their annual audit plans (enclosed as **Annexure- A.IV**) and others may submit annual audit plan for FY 2024-25 at the earliest.

**Third party protection audit:**

A.4.4 As per clause 15 of IEGC 2023:

- *All users shall also conduct third party protection audit of each sub-station at 220 kV and above (132 kV and above in NER) once in five years or earlier as advised by the respective RPC.*

A.4.5 Some utilities have submitted their third-party protection audit plans (enclosed as **Annexure-A.V**) and other remaining may submit the same at the earliest.

A.4.6 The utilities may update the status of 3<sup>rd</sup> party protection audit as per the submitted audit plans. Subsequently, the audit reports along with compliance status may be submitted to NRPC Secretariat regularly.

A.4.7 Most of the utilities have not still submitted the action taken reports against the observations of audits. The same may be expedited.

**Decision required from Forum:**

### **Agenda of 55<sup>th</sup> Protection Sub-Committee Meeting (20<sup>th</sup> December, 2024)**

*Utilities may submit annual audit plan for FY 2024-25 & 3<sup>rd</sup> Party Protection audit plan and comply the same timely. Compliance report for the audited substation may be submitted within one month of audit.*

#### **A.5. Annual protection audit plan for FY 2025-26 (agenda by NRPC Secretariat)**

A.5.1 As per clause 15 of IEGC 2023;

- *Annual audit plan for the next financial year shall be submitted by the users to their respective RPC by 31st October. The users shall adhere to the annual audit plan and report compliance of the same to their respective RPC.*

A.5.2 In view of above, all utilities were requested to submit the annual protection audit plan for FY-2025-26 latest by 31<sup>st</sup> October 2024 in the 53<sup>rd</sup> PSC meeting. Further, concerned utilities were requested to submit the same at the earliest in the 54<sup>th</sup> PSC meeting.

A.5.3 In view of above, some utilities have submitted their annual audit plans (enclosed as **Annexure- A.VI**) and others may submit annual audit plan for FY 2025-26 at the earliest.

#### **Decision required from Forum:**

*Utilities may submit annual internal protection audit plan for FY 2025-26 at the earliest and comply the submitted schedule timely.*

#### **A.6. Observations and Compliance of recommendations of protection audit (agenda by NRPC Secretariat)**

A.6.1 As per clause 15 of IEGC 2023;

- *All users shall conduct internal audit of their protection systems annually, and any shortcomings identified shall be rectified and informed to their respective RPC. The audit report along with action plan for rectification of deficiencies detected, if any, shall be shared with respective RPC for users connected at 220 kV and above (132 kV and above in NER).*
- *All users shall also conduct third party protection audit of each sub-station at 220 kV and above (132 kV and above in NER) **once in five years** or earlier as advised by the respective RPC.*
- *The protection audit reports, along with action plan for rectification of deficiencies detected, if any, shall be submitted to the respective RPC **and***

**Agenda of 55<sup>th</sup> Protection Sub-Committee Meeting (20<sup>th</sup> December, 2024)**

*RLDC or SLDC, as the case may be, **within a month of submission of third-party audit report.** The necessary compliance to such protection audit report shall be followed up regularly in the respective RPC.*

- A.6.2 Utilities have submitted the internal audit report based on the audit done at their substations. After the 54<sup>th</sup> Protection Sub-Committee meeting, received internal Protection Audit report from LPGCL is attached as **Annexure-A.VII** and received reports of 3<sup>rd</sup> Party audit (from HPSEBL, PTCUL, RVUNL & UJVNL) are attached as **Annexure-A.VIII** for discussion.
- A.6.3 However, compliance of audit recommendations has not been reported to NRPC Secretariat. HPSEBL has submitted the compliance reports of third-party audit along with report.
- A.6.4 The concerned utilities may submit the protection audit report (for audited S/s as per submitted plan) and action plan for rectification of deficiencies within a month after issuance of audit report.

**Decision required from Forum:**

*Forum may discuss audit report as well as action taken by utilities on recommendations of audit.*

**A.7. Provisional protection clearance during FTC in October 2024 (agenda by NRPC Secretariat)**

- A.7.1 Provisional protection clearance during FTC in November 2024 allowed by NRLDC is attached as **Annexure-A.IX**.

**Decision required from Forum:**

*Concerned Utilities may share agenda for approval of PSC forum and may send settings files to NRPC Secretariat for updation of database.*

**A.8. Tripping of every transmission line whenever Broken Conductor Alarm on 220kV feeder and loss of VT (in any of phase) at 220kV bus is observed simultaneously (agenda by RVPN)**

- A.8.1 RVPN vide letter dated 28.10.2024 submitted that "Protection Philosophy/ Protocol

### **Agenda of 55<sup>th</sup> Protection Sub-Committee Meeting (20<sup>th</sup> December, 2024)**

of Northern Region” has been incorporated with “Protection for broken conductor” as Alarm indication for transmission line and cable. A rider has been provided that tripping may be considered for radial lines to protect single phasing of transformers.

- A.8.2 Further, RVPN has mentioned that at the substations which operate radially, it provides us liberty to enable the tripping of line with broken conductor alarm to prevent single phasing of transformers but in case of substation fed by two or more transmission lines, this setting is to be kept on alarm mode only.
- A.8.3 For example, in case of a substation connected with two lines (i.e. it is in ring), if one line is out due to fault or by the direction of SLDC, the substation becomes radially connected and setting for the Broken Conductor remains on Alarm. This may lead to single phasing of transformer if conductor of remaining line breaks. The same may be applied to the cases with more lines.
- A.8.4 Therefore, RVPN has proposed to have tripping of every transmission line whenever Broken Conductor Alarm on 220kV feeder and loss of VT (in any of phase) at 220kV bus is observed simultaneously.
- A.8.5 It is to mention that the above agenda was discussed in the 54<sup>th</sup> PSC meeting wherein Forum requested all the members to share the comments on the proposal of RVPN and deferred the agenda to next PSC meeting for deliberation based on the compiled received inputs of members.
- A.8.6 In view of above, comments/inputs/observations/suggestions on the above proposal of RVPN were sought from all PSC members vide email dated 02.12.2024. UPPTCL, LPGCL (enclosed as **Annexure-A.X**) submitted the comments.
- A.8.7 NPCIL vide letter dated 06.12.2024 intimated that NPCIL have implemented the tripping on broken conductor for 220kV and 400kV substations since 2013.
- A.8.8 Accordingly, members may deliberate on the above proposal of RVPN considering the received comments.

#### **Decision required from Forum:**

*Members may discuss and consider to amend the protection philosophy accordingly.*

### **A.9. Tripping of line reactors due to ferro-resonance (agenda by POWERGRID)**

- A.9.1 POWERGRID has intimated that they are facing critical problem of LC Ferro-Resonance in several 765kV & 400kV Lines of Rajasthan.

**Agenda of 55<sup>th</sup> Protection Sub-Committee Meeting (20<sup>th</sup> December, 2024)**

- A.9.2 As per POWERGRID Guidelines, Relay Scheme (at One end of Transmission Line) needs to be modified for all such cases to achieve removal of one end Line Reactor during condition of 1-phase AR cycle / any Line Fault in order to avoid occurrence of LC Ferro-Resonance.
- A.9.3 POWERGRID has also mentioned that similar relay scheme is already approved in 129<sup>th</sup> Protection Coordination Meeting (in 2017) of WRPC due to Ferro-resonance seen in other regions such as 765 kV Indore-Bhopal line.
- A.9.4 POWERGRID has further submitted that for implementation of above modification in relay scheme, shutdown of several elements is required.
- A.9.5 Accordingly, POWERGRID has requested that all necessary shutdown of following listed elements may be approved under **“System Constraints”** head, without loss of availability of POWERGRID / PBTSL:

<b>Name of Line</b>	<b>Location where TRIPPING Scheme of Line Reactor is implemented to avoid LC Ferro-Resonance</b>	<b>Owner of Asset</b>
400kV Bikaner-2 Khetri Ckt-1 Line	<b>Bikaner-2</b> for 400kV, 80 MVAR Line Reactor	<b>PBTSL</b>
400kV Bikaner-2 Khetri Ckt-2 Line	<b>Bikaner-2</b> for 400kV, 80 MVAR Line Reactor	<b>PBTSL</b>
400kV Bikaner-2 Khetri Ckt-3 Line	<b>Bikaner-2</b> for 400kV, 80 MVAR Line Reactor	<b>PBTSL</b>
400kV Bikaner-2 Khetri Ckt-4 Line	<b>Bikaner-2</b> for 400kV, 80 MVAR Line Reactor	<b>PBTSL</b>
765kV Chittorgarh-Banaskatha Ckt-1 Line	<b>Chittorgarh</b> for 765kV, 240 MVAR Line Reactor	<b>PGCIL</b>

**Decision required from Forum:**

*Members may discuss.*

**A.10. Frequent faults in 220kV downstream feeders and need for review of Auto-Reclosure settings in these 220kV lines (agenda by POWERGRID)**

- A.10.1 POWERGRID has submitted that frequent faults are being observed in the downstream (220kV) lines fully owned by state utilities or the 220kV lines having major portion maintained by state utilities. The details of these lines are as mentioned below:

<b>Sr. No.</b>	<b>Name of the line</b>	<b>Line</b>	<b>No. of faults in</b>
----------------	-------------------------	-------------	-------------------------

**Agenda of 55<sup>th</sup> Protection Sub-Committee Meeting (20<sup>th</sup> December, 2024)**

		<b>Ownership</b>	<b>last two years</b>
1	220kV Baghpat (PG)-Shamli (UP) Line	UPPTCL	84
2	220kV Baghpat (PG)-Mandola Vihar (UP) Line	UPPTCL	38
3	220kV Baghpat (PG)-Baghpat(UP) Ckt-I	UPPTCL	8
4	220kV Baghpat (PG)-Baghpat(UP) Ckt-II	UPPTCL	23
5	220kV Baghpat (PG)-Modipuram(UP) Ckt-I	UPPTCL	31
6	220kV Baghpat (PG)-Modipuram(UP) Ckt-II	UPPTCL	18
7	220kV Meerut (PG)-Nara(UP)	UPPTCL/PG	56
8	220kV Hisar (PG)-Fatehabad lines (HVPNL)	HVPNL	60
9	220kV Hisar (PG)-Fatehabad lines (HVPNL)	HVPNL	45
10	220 Saharanpur (PG)- Shamli (UP)	UPPTCL	60
11	220 Saharanpur (PG)- Khara (UP)	UPPTCL	40

A.10.2 All these lines, except the 220kV Meerut-Nara lines, are fully owned by state utilities. As evident from the aforementioned tables, these lines experience frequent faults, which place significant stress on the switchyard equipment as well as the interconnecting transformers at the POWERGRID substations. These recurring faults have already resulted in the failure of GIS at the Baghpat Substation and the failure of a circuit breaker at the Meerut Substation.

A.10.3 Notably, all 56 faults in the 220kV Meerut- Nara line over the past two years occurred in the UPPTCL portion. Considering the high number of faults in the aforesaid 220kV lines, it is proposed to implement adaptive AR for these lines at the POWERGRID end.

A.10.4 Copy of various communications with UPPTCL and HVPN is attached as **Annexure-A.XI**.

**Agenda of 55<sup>th</sup> Protection Sub-Committee Meeting (20<sup>th</sup> December, 2024)**

A.10.5 POWERGRID has requested Forum to direct UPPTCL and HVPNL for urgent remedial action, including thorough patrolling of the affected lines, rectify defects and maintain system reliability.

**Decision required from Forum:**

*Members may discuss and consider to allow Adaptive Auto reclosure for these lines at the POWREGRID end accordingly.*

**A.11. Review of Zone-2 & Zone-3 time delay settings at Mandola (PG) substation for 220kV Mandola (PG)-Gopalpur (DTL) lines (agenda by POWERGRID)**

A.11.1 POWERGRID has intimated that 220kV Mandola (PG)-Gopalpur (DTL) lines are experiencing faults that are often cleared in Zone 2/Zone 3 from the Mandola end due to the failure of the protection system at the Gopalpur Substation. These delayed fault clearances are causing stress on the ICTs at Mandola Substation, as these faults are being fed by the ICTs installed at Mandola. Most of the switchgear in the 220 kV bays has aged, and such frequent and prolonged fault feeding increases the risk of switchgear failure.

A.11.2 As a stop-gap arrangement, DTL has implemented IDMT O/C & E/F protection for the Mandola-Gopalpur Line-1 and Line-2. However, this protection will only trip after a time delay in cases where faults are not cleared from the Gopalpur end. In light of the above, it is proposed that the Zone-2 and Zone-3-time delay settings of the Mandola-Gopalpur lines at the Mandola end to operate instantaneously, rather than with a time delay, in order to prevent further stress on the system.

A.11.3 Copy of various communications of POWERGRID with DTL is attached as **Annexure-A.XII.**

**Decision required from Forum:**

*Members may discuss on the proposal of POWERGRID for changing Zone-2 and Zone-3-time delay settings of the Mandola-Gopalpur lines at the Mandola end to operate instantaneously.*

**A.12. Review of Zone-2 & Zone-3 time delay settings at Sonipat (PG) substation for 220kV Sonipat (PG)-Mohana (HVPNL) lines (agenda by POWERGRID)**

A.12.1 POWERGRID has submitted that the protection system at the Mohana (HVPNL) substation is not clearing faults in the downstream feeders as well as the faults in the



**Agenda of 55<sup>th</sup> Protection Sub-Committee Meeting (20<sup>th</sup> December, 2024)**

220kV Sonipat (PG)-Mohana (HVPNL) line. These lines frequently trip in Zone-2 and Zone-3. The non-operation of the protection system at the Mohana substation causes delayed fault clearance from the Sonipat (PG) substation. This delayed fault clearance places unnecessary stress on the transformers and other switchyard equipment at the Sonipat (PG) end, which is undesirable from a system reliability perspective.

A.12.2 In view of this, it is proposed to revise the Zone-2 and Zone-3-time delay settings at the Sonipat (PG) substation for the 220kV Sonipat (PG)-Mohana (HVPNL) lines to operate instantaneously, rather than with a time delay, to prevent further stress on the system.

A.12.3 Copy of various communications of POWERGRID with HVPNL is attached as **Annexure-A.XIII.**

**Decision required from Forum:**

*Members may discuss on the proposal of POWERGRID to revise the Zone-2 and Zone-3-time delay settings at the Sonipat (PG) substation for the 220kV Sonipat (PG)-Mohana (HVPNL) lines to operate instantaneously.*

**A.13. Tripping of Rihand Stage-3 Units, during Monopole Ground Return Mode Operation of Rihand Dadri HVDC line (agenda by NTPC)**

A.13.1 NTPC has submitted that the problem of abnormal noise & excessive vibrations in GTs of Rihand Stage-III and Vindhyachal Stage-IV during monopole operation of HVDC Rihand – Dadri link was earlier discussed, and it was decided in 45<sup>th</sup> TCC meeting (27<sup>th</sup> & 28<sup>th</sup> August 2020) and 48<sup>th</sup> NRPC Meeting (2<sup>nd</sup> September 2020) to limit HVDC line loading to 300MW during monopole ground return operation.

A.13.2 During such monopole ground return operation, Stage-3 units of 2 X 500 MW (Unit-05 & 06) tripped on 11.11.2024 at NTPC-Rihand. Rihand Unit # 5 tripped on Buchholz relay protection in GT-5Y at 01:13:27 hrs & Rihand Unit # 6 tripped in GT-6R & 6B transformers at 01:16:40 hrs. After units tripping, DC current in GT/ST neutral were found significantly high at 300 MW HVDC power flow, so same was reduced to 200 MW and finally to 100 MW as mentioned in below table to minimize the DC current.

Sr No.	Date	Unit	DC Current at 300MW	DC current at 200MW HVDC	DC current at 100MW HVDC

**Agenda of 55<sup>th</sup> Protection Sub-Committee Meeting (20<sup>th</sup> December, 2024)**

			<b>HVDC flow</b>	<b>flow</b>	<b>flow</b>
1	11.11.2024	GT-1 (400/20 kV)	16.1 Amp	9.5 Amp	0.2 Amp
2	11.11.2024	GT-2(400/20 kV)	16.3 Amp	9.6 Amp	1.6 Amp
3	11.11.2024	GT-3(400/21 kV)	15.1 Amp	8.3 Amp	0.5 Amp
4	11.11.2024	GT-4(400/21 kV)	15.0 Amp	10.0 Amp	0.6 Amp
5	11.11.2024	ST-5 (400/11/11 kV)	37.1 Amp	24.0 Amp	0.6 Amp
6	11.11.2024	ST-6 (400/11/11 kV)	37.5 Amp	24.6 Amp	0.5 Amp

A.13.3 The unwarranted unit outages, causing heavy loss of revenue to NTPC and which is having detrimental impact to the health and life of these critical & costly assets installed at Rihand.

A.13.4 In view of above, NTPC has proposed to make a detailed study in respect of the following aspects:

- i. Establish root causes for high DC current in flow via neutral, during monopole operation with ground return.
- ii. Establish a safe operation procedure of HVDC system in different modes, especially with load-limiting features during monopole operation in different situations/ operations

**Decision required from Forum:**

*Members may discuss.*

**Agenda of 55<sup>th</sup> Protection Sub-Committee Meeting (20<sup>th</sup> December, 2024)**

**A.14. Centralized Database for Protection Settings in Northern Region to be implemented under PSDF (agenda by NRPC Secretariat)**

A.14.1 In 48<sup>th</sup> TCC & 70<sup>th</sup> NRPC Meeting (held on 17-18 Nov 2023), NRPC Committee has approved for development of a portal through PSDF for Centralized database containing details of relay settings for grid elements connected to 220 kV and above. The scope was already approved in the above meeting.

A.14.2 Further, a meeting was held on 08.01.2024 with POWERGRID to deliberate on tendering, wherein POWERGRID desired number of sub-stations and elements for which relay details shall be modelled in Centralized Database for preparation of estimate of work for implementation of the portal.

A.14.3 In view of above, it was requested vide letter dtd. 23.01.2024 to NRLDC/NLDC and SLDCs of Northern region to furnish the details of all elements connected at 220 kV and above, in respective control area latest by 30.01.2024. A reminder mail dtd. 06.02.2024 was also sent for the same.

A.14.4 Based on the received data, compiled status was presented in the 50<sup>th</sup> PSC meeting held on 29.04.2024. Subsequently, Utilities were requested to send pending data for no. of relays and substations within a week. It was also decided to consider tentative/average data if details are not submitted by utilities within a week.

A.14.5 Compilation of numbers for sub-station, relay and licensee for calculation tool has been done. After considering assumption, the numbers are as below:

S.N.	Number of substations (220 kV and above in Northern Region)	Number of relays	Number of licenses of protection calculation tool
1	965	39380	87  (Already approved in 49 <sup>th</sup> PSC meeting)

Details are attached as **Annexure- A.XIV**.

A.14.6 It is also to mention that PSDF Secretariat vide letter dated 04.12.2024 has intimated that now PSDF fund has been opened which was blocked for some time. Accordingly, NRPC Secretariat is putting up agenda in upcoming TCC/NRPC meeting for approval of DPR for this project.

**Agenda of 55<sup>th</sup> Protection Sub-Committee Meeting (20<sup>th</sup> December, 2024)**

A.14.7 The scope of database portal was approved in 48<sup>th</sup> TCC & 70<sup>th</sup> NRPC Meeting (held on 17-18 Nov 2023) as attached as **Annexure- A.XV**. There is need for discussion on point no. D of approved scope as procedure for approval of protection setting has been recently approved in 75<sup>th</sup> NRPC meeting as attached as **Annexure-A.XVI**. Accordingly, point no. D may be discussed and finalized.

**Decision required from Forum:**

- i. Approval of number of sub-station and relays for the project.
- ii. Review of scope of the project.

**A.15. Use of line VT/CVT for Main-1 and Bus VT/CVT for Main-2 Distance Protection Scheme on 220kV lines (agenda by RVPN)**

A.15.1 RVPN has mentioned that Main -1 & Main-2 are two independent high speed protection groups used to safeguard section of the power system against short circuit faults/ abnormal system conditions, i.e., over voltage, broken conductor etc.

A.15.2 During the discussion in the 54<sup>th</sup> Protection Sub-Committee meeting, it was observed that many utilities are using line VT/CVT for both Main-1 & Main -2 Distance Protection Schemes.

A.15.3 RVPN has proposed the following as below-

- i. The Main-1 & Main -2 protection shall be numerical relays of different makes or employ different fault detection algorithm. The logic behind above is that every type of fault should be detected by either relay, i.e. no fault should remain undetected by protection schemes.
- ii. Normally, two different CT cores are used for current input to Main-1 and Main-2 DPS but as mentioned above, if only line VT/CVT is used for both Main-1 and Main-2 DPS, then in case of loss of output from line CT/CVT or error in measurement by line VT/CVT would lead to either non operative or mal-operation of both Main-1 & Main -2 DPS.
- iii. In view of above, RVPN has suggested to use line CT/CVT for Main-1 and Bus VT/CVT for Main-2 Distance Protection Scheme.

**Decision required from Forum:**

*Forum may discuss.*

**Agenda of 55<sup>th</sup> Protection Sub-Committee Meeting (20<sup>th</sup> December, 2024)****Part-B: NRLDC****B.1 Status of remedial actions recommended during previous PSC meetings (agenda by NRLDC)**

- B.1.1 As per the discussion in pervious PSC meetings, necessary remedial actions were recommended based on the analysis and discussion of the grid events. It is expected that necessary actions would have taken place. In view of the same, constituents are requested to share the status of remedial actions taken. List of points to be discussed in 55<sup>th</sup> PSC meeting is attached as **Annexure-B.I**. Constituents can email the details via mail to NRLDC and NRPC.

***Decision required from Forum:***

*Members may like to discuss.*

**B.2 Multiple elements tripping events in Northern region in the month of November'24 (agenda by NRLDC)**

- B.2.1 A total of 10 grid events occurred in the month of **November'24** of which **01** are of GD-1 category, **04** are of GI-2 Category and **05** are of GI-1 Category. The tripping report of all the events have been issued from NRLDC. A list of all these events is attached at **Annexure-B.II**.
- B.2.2 Maximum delayed clearance of fault observed in event of multiple elements tripping at 400/220/132kV Merta (RS) on 11th November, 2024 (As per PMU at Merta(RS), R-Y-B phase to phase fault was observed with delayed fault clearance time of 720 msec is observed).
- B.2.3 Delayed clearance of fault (more than 100ms for 400kV and 160ms for 220kV system) observed in total 03 events out of 10 grid events occurred in the month. In 02 (no.) of grid event, there was no fault in the grid.
- B.2.4 Remedial actions taken by constituents to avoid such multiple elements tripping may be shared.
- B.2.5 As per IEGC clause 37.2 (c), Disturbance Recorder (DR), station Event Logger (EL), Data Acquisition System (DAS) shall be submitted within 24 hrs of the event and as per IEGC clause 37.2 (e), the user shall submit a detailed report in the case of grid

**Agenda of 55<sup>th</sup> Protection Sub-Committee Meeting (20<sup>th</sup> December, 2024)**

disturbance or grid incidence within one (1) week of the occurrence of event to RLDC and RPC.

- B.2.6 Members may take necessary preventive measures to avoid such grid incidents / disturbances in future and report actions taken by respective utilities in OCC & PSC Forum. Moreover, utilities may impress upon all concerned for providing the Preliminary Report, DR/EL & Detailed Report of the events to RLDC in line with the regulations.

**Decision required from Forum:**

*Members may like to discuss.*

**B.3 Analysis of the tripping events occurred during November-2024 and status of remedial action taken (agenda by NRLDC)**

**a) Frequent elements tripping during November 2024:**

- B.3.1 The following transmission elements were frequently tripping during the month of **November'24**:

S. NO.	Element Name	No. of forced outages	Utility/SLDC
1	220 KV RAPS_A(NP)-Sakatpura (RS) (RS) Ckt-1	5	Raj/NPCIL
2	220 KV RAPS_A(NP)-Sakatpura (RS) (RS) Ckt-2	4	Raj/NPCIL
3	400 KV Agra-Unnao (UP) Ckt-1	4	UP
4	400 KV Aligarh-Shamli (UP) Ckt-2	3	UP
5	400 KV Aligarh-Sikandrabad (UP) Ckt-1	3	UP
6	400 KV Amritsar(PG)-Makhu(PS) (PSTCL) Ckt-1	3	PG/PS
7	400 KV Anpara_B(UPUN)-Mau (UP) (UP) Ckt-1	3	UP
8	400 KV Bareilly-Unnao (UP) Ckt-1	4	UP
9	400 KV Talwandi Saboo(PSG)-Nakodar (PSG) (PS) Ckt-1	3	PS

- B.3.2 List of tripping is attached as **Annexure-B.III**.

- B.3.3 It may be noted that frequent tripping of such elements affects the reliability and security of the grid. Hence, utilities are requested to analyse the root cause of the

**Agenda of 55<sup>th</sup> Protection Sub-Committee Meeting (20<sup>th</sup> December, 2024)**

tripping and share the remedial measures taken/being taken in this respect.

**b) Protection related issues in multiple elements tripping, detailed analysis of the events and status of remedial measures:**

B.3.4 The list of major tripping events occurred during November 2024 is attached as **Annexure-B.IV** Concerned constituents/utilities are requested to share the detailed analysis of the tripping elements along with status of remedial action taken/to be taken.

B.3.5 Utilities are requested to prepare detailed analysis report and present the event details during 55<sup>th</sup> PSC meeting. Events involving more than one utility may be jointly prepared and presented.

**Decision required from Forum:**

*Members may like to discuss.*

**B.4 Details of tripping of Inter-Regional lines from Northern Region for November'24 (agenda by NRLDC)**

B.4.1 A total of 5 inter-regional lines tripping occurred in the month of **November'24**. The list is attached at **Annexure-B.V**. The status of receipt of preliminary reports, DR/EL within 24hrs of the event and fault clearing time as per PMU data has also been mentioned in the table. The non-receipt of DR/EL & preliminary report within 24hrs of the event from SLDCs / ISTS licensees / ISGSs is in violation of regulation 37.2(c) of IEGC and regulation 15(3) of CEA Grid Standards.

B.4.2 As per regulations, all the utilities shall furnish the DR/EL, flag details & preliminary report to RLDC/RPC within 24hrs of the event. They shall also furnish the detailed investigation report within 7 days of the event if fault clearance time is higher than that mandated by CEA (Grid Standard) Regulations.

**Decision required from Forum:**

*Members may please note and advise the concerned for taking corrective action to avoid such tripping as well as timely submission of the information.*

**Agenda of 55<sup>th</sup> Protection Sub-Committee Meeting (20<sup>th</sup> December, 2024)**

**B.5 Status of Bus bar protection (agenda by NRLDC)**

B.5.1 Clause - 4 in schedule - V of Central Electricity Authority (Technical Standards for Construction of Electrical Plants and Electric Lines) Regulations, 2022 reads as

*"Bus bar protection and local breaker backup protection shall be provided in 220kV and higher voltage interconnecting sub-stations as well as in all generating station switchyards".*

B.5.2 During analysis of many grid incidents/disturbances, it has been found that the Busbar protection at the affected substation was not present or non-operational which resulted in considerably increasing both the number of affected elements and fault clearance time. Accordingly, it becomes critical to monitor and keep Busbar protection at all the 220 kV and above voltage level substations healthy and operational.

B.5.3 Continuous follow-ups are being done at OCC & PSC forum to expedite the commissioning of bus bar protection at 220kV & above stations and to ensure their healthiness. On the basis of details received till date, it is observed that status of bus bar protection has been improved however, further improvement is desired.

B.5.4 Constituent wise status of bus bar protection where bus bar protection is either not installed or installed but not operational along with present status as per detail received from constituents is attached as **Annexure-B.VI**.

B.5.5 Constituents are requested to share the present status of remedial action taken/to be taken regarding commissioning and healthiness of bus bar protection at 220kV & above substations and also expedite the implementation of bus bar protection.

***Decision required from Forum:***

*Members may like to discuss.*

**B.6 Replacement of electromechanical relays with numerical relays (agenda by NRLDC)**

B.6.1 On Clause-37.2(c) of IEGC, clause-15(4) of CEA Grid standards and clause-48(4) of CEA Construction Standards 2022 mandates that *"each line or transformer or reactor*



**Agenda of 55<sup>th</sup> Protection Sub-Committee Meeting (20<sup>th</sup> December, 2024)**

*or any other bay shall be provided with facility for disturbance recording, event logging and time synchronizing equipment”.*

- B.6.2 During analysis of grid incidents/disturbances, it has been found that there are few stations where electromechanical relays are still in use and thus disturbance recorder are not available there which accounts for violation of Clause-37.2(c) of IEGC, clause-15(4) of CEA Grid Standards and clause 48(4) CEA Construction Standards 2022.
- B.6.3 In addition, clause-3 in part III (Grid Connectivity Standards applicable to Transmission Line and Sub-Station) of Standards for Connectivity to the Grid, 2007 reads as
- B.6.4 “Two main numerical Distance Protection Schemes shall be provided on all the transmission lines of 220 kV and above for all new sub-stations. For existing sub-stations, this shall be implemented in a reasonable time frame”
- B.6.5 It is known that Disturbance recorder (DR) is essential for analysis of grid incidents/disturbances. Its non-availability eventually affects the proper analysis of grid incidents/disturbances and monitoring of protection system.
- B.6.6 Continuous follow-ups is being done at OCC & PSC forum. During the meeting, all the constituents/SLDC/STU were requested to review the same in their control area and take expeditious actions to replace electromechanical relays with numerical relays.
- B.6.7 Constituent wise details of static/electromechanical type protection relays at their respective substations along with its present status per detail received from constituents is attached as **Annexure-B.VII**.
- B.6.8 Constituents are requested to share the status of remedial action taken/to be taken regarding replacement of static/electromechanical relay with numerical relays at 220kV & above substations and expedite the process of replacement of static/electromechanical relay with numerical relays.

**Decision required from Forum:**

*Members may like to discuss.*

*Agenda of 55<sup>th</sup> Protection Sub-Committee Meeting (20<sup>th</sup> December, 2024)*

**B.7 Availability and Standardization of recording instrument (Disturbance recorder and Station Event Logger) and status of work regarding undertaking submitted during First Time Charging of elements (agenda by NRLDC)**

B.7.1 As per IEGC clause 17

- 1) *All users shall keep the recording instruments (disturbance recorder and event logger) in proper working condition.*
- 2) *The disturbance recorders shall have time synchronization and a standard format for recording analogue and digital signals.*

B.7.2 IEGC clause 37.2 (c) also mandates the submission of Disturbance Recorder (DR), station Event Logger (EL), Data Acquisition System (DAS) within 24 hrs of the event.

B.7.3 Data of recording instruments (DR/EL) are very helpful in grid event analysis and also is being used in availability verification of transmission lines. Complete and conclusive analysis of any grid event is not possible without these recording instruments and thus their standardization is very important.

B.7.4 Therefore, availability of disturbance recorder with standardization, time sync and correct nomenclature and station event logger need to be ensured by users at the station of their respective control area.

B.7.5 In view of the above, all the constituents are requested to share the details w.r.t. availability and standardization of disturbance recorder and event logger at the station of their respective control area in format attached as **Annexure-B. VIII**.

B.7.6 Details were received from Rajasthan, UP, Uttarakhand & Haryana only. Details received is attached as **Annexure-B. VIII**

B.7.7 Members are requested to share the share the details w.r.t. availability and standardization of disturbance recorder and event logger at the station of their respective control area. Members are also requested to submit the status of work regarding undertaking submitted during First Time Charging of elements.

***Decision required from Forum:***

*Members may like to discuss.*

*Agenda of 55<sup>th</sup> Protection Sub-Committee Meeting (20<sup>th</sup> December, 2024)*

**B.8 Corrective action for healthiness of 500kV Mundra-Mahindergarh SPS (agenda by NRLDC)**

- B.8.1 On 17th May 2024 on outage of both pole (carrying total ~1500MW), SPS of 500kV HVDC Mundra-Mahindergarh inter regional link didn't operate. This issue was discussed during 51<sup>st</sup> PSC meeting and ADANI was requested to share the details w.r.t. SPS operation during the meeting.
- B.8.2 Further, NRLDC in coordination with NLDC conducted an online discussion meeting with concerned stakeholders (SLDCs, ADANI, POWERGRID) on 12<sup>th</sup> August 2024, for further remedial actions required to make this SPS healthy.
- B.8.3 Following actions were decided during the meeting:
- i. POWERGRID, ADANI and concerned states were requested to identify the issue in communication links and take expeditious actions to make the all the communication link healthy. POWERGRID & ADANI shall review the healthiness of SPS system at different load centres and communication path between them in coordination with the SLDCs.
  - ii. States were requested to go through the details of load feeders mentioned in SPS document and share the changes / modifications as per present scenario and share the inputs w.r.t. unavailability in identified load feeders and load shedding. SLDCs shall share the revised updated feeder details (radial) along with expected average/peak load relief through respective feeders.
  - iii. SLDCs in coordination with their transmission and protection team shall share the status and healthiness of existing SPS system along with details of availability of communication path for incorporation of proposed revised/additional feeders.
- B.8.4 Load end details have been received from UP, Haryana, Punjab Rajasthan & Delhi. Details are attached as **Annexure-B. IX**.
- B.8.5 ADANI has submitted the status of healthiness of communication network and hardware system at different locations on the basis of preliminary inspection. As per details submitted, counter status was found OFF at Alwar, Ratangarh, Gobindgarh, Malerkotla, Bamnauli, Shamli and Dhanonda.
- B.8.6 Details of nodal officer of different substation involved in SPS scheme has already been shared with ADANI team for coordination and further remedial actions.

**Agenda of 55<sup>th</sup> Protection Sub-Committee Meeting (20<sup>th</sup> December, 2024)**

- B.8.7 During 53<sup>rd</sup> PSC meeting, ADANI was requested to coordinate with the respective states to rectify the issues in the SPS system and share the status of remedial action taken / planned to be taken. Desired remedial actions need to be expedited.
- B.8.8 ADANI agreed for the same and stated that update would be given within 01 week. However, no detail received yet from ADANI.
- B.8.9 During discussion in 54<sup>th</sup> PSC meeting also there was no further update received from ADANI team.
- B.8.10 In view of above, PSC forum is requested to discuss the issue and propose action plan for necessary remedial action plans needed for making SPS scheme of HVDC Mundra-Mahindergarh healthy & operational.

**Decision required from Forum:**

*Members may like to discuss.*

**Part C: Final Protection Settings Approval by PSC Forum for FTCs which have been provisionally allowed by NRLDC/SLDCs**

**C.1. Approval of protection settings in compliance of IEGC 2023 (agenda by AGEL)**

- C.1.1 AGEL vide email dated 10.12.2024 submitted the Adani Green Energy Twenty-Four Limited (AGE24L) has charged the electrical equipment of the 500 MW Solar Plant at Bhimsar, Rajasthan on 28.11.2024.
- C.1.2 AGEL has also mentioned that the settings (available at NRPC website link <http://164.100.60.165/meetings/PCC/PCC55/Bhimsar.zip> ) have been provisionally approved by NRLDC on 26.11.2024.
- C.1.3 Further, as per protection setting procedure finalized in 75<sup>th</sup> NRPC meeting, utility has to get final approval of settings in PSC meeting, therefore, AGEL has put up the implemented settings (available at NRPC website link <http://164.100.60.165/meetings/PCC/PCC55/Bhimsar.zip> ) for approval of Forum.

**Decision required from Forum:**

**Agenda of 55<sup>th</sup> Protection Sub-Committee Meeting (20<sup>th</sup> December, 2024)**

Forum may approve the protection settings (available at <http://164.100.60.165/meetings/PCC/PCC55/Bhimsar.zip> ) after deliberation and may suggest changes, if any.

**C.2. Approval of protection settings in compliance of IEGC 2023 (agenda by Rajasthan SLDC)**

C.2.1 Rajasthan SLDC vide letter dated 10.12.2024 submitted the details of First Time Charging (FTC) of elements as below: -

S. No.	Element Name	Relevant Protection Setting available at
1	400 kV Bay No. 412A (434) of 400 kV Jaisalmer 2-Corneight Parks Pvt. Ltd. transmission line.	<a href="http://164.100.60.165/meetings/PCC/PCC55/Annexure_I.pdf">http://164.100.60.165/meetings/PCC/PCC55/Annexure_I.pdf</a>
2	400 kV Bay No. 412T (435) of 400 kV Jaisalmer2-Corneight Parks Pvt. Ltd. transmission line and future transmission bay at Jaisalmer.	<a href="http://164.100.60.165/meetings/PCC/PCC55/Annexure_II.pdf">http://164.100.60.165/meetings/PCC/PCC55/Annexure_II.pdf</a>
3	400 kV S/C line from 400 kV GSS Jaisalmer 2 to Corneight Parks Pvt. Ltd. alongwith main bay No. 401 and Tie bay No. 402 at Corneight Parks Private Limited	<a href="http://164.100.60.165/meetings/PCC/PCC55/Annexure_II.pdf">http://164.100.60.165/meetings/PCC/PCC55/Annexure_II.pdf</a>
4	400/33 kV, 200 MVA, Shirdi Sai make ICT-1, Sr. No. 100023/01 alongwith Main bay No. 403 at Corneight Parks Private Limited.	<a href="http://164.100.60.165/meetings/PCC/PCC55/Annexure_II.pdf">http://164.100.60.165/meetings/PCC/PCC55/Annexure_II.pdf</a>
5	400/33 kV, 200 MVA, Shirdi Sai make ICT-2, Sr. No.100023/02 alongwith Main bay No. 406 and Tie bay No. 405 at Corneight Parks Private Limited.	<a href="http://164.100.60.165/meetings/PCC/PCC55/Annexure_II.pdf">http://164.100.60.165/meetings/PCC/PCC55/Annexure_II.pdf</a>

C.2.2 Further, as per protection setting procedure finalized in 75<sup>th</sup> NRPC meeting, utility has to get final approval of settings in PSC meeting, therefore, Rajasthan SLDC has put up these settings for approval of Forum.

**Decision required from Forum:**

**Agenda of 55<sup>th</sup> Protection Sub-Committee Meeting (20<sup>th</sup> December, 2024)**

Forum may approve the protection settings (available at [http://164.100.60.165/meetings/PCC/PCC55/Annexure I.pdf](http://164.100.60.165/meetings/PCC/PCC55/Annexure_I.pdf) & [http://164.100.60.165/meetings/PCC/PCC55/Annexure II.pdf](http://164.100.60.165/meetings/PCC/PCC55/Annexure_II.pdf) ) after deliberation and may suggest changes, if any.

**C.3. Approval of protection settings in compliance of IEGC 2023 (agenda by HVPNL)**

- C.3.1 HVPN vide email dated 11.12.2024 intimated that 220/132 KV 100 MVA T-4 T/F commissioned at 220 KV S/Stn., Masudpur on 28.11.2024.
- C.3.2 Accordingly, HVPN has submitted the settings (enclosed as **Annexure- C.I**) for approval.

**Decision required from Forum:**

Forum may approve the protection settings (enclosed as **Annexure-C.I**) after deliberation and may suggest changes, if any.

**C.4. Post-facto Approval of Transmission Line Protection Scheme for LILO of one ckt of 220kV Sector-72 (PG) – Sector-72 (HVPN) Gurugram at 220kV substation Sector-15 HVPN Gurugram (agenda by HVPNL)**

- C.4.1 HVPNL has submitted that the work of construction of LILO of one ckt of 220kV Sector-72 (PG) – Sector-72 (HVPN) Gurugram (200 mtr) at 220kV substation Sector-15 HVPN Gurugram was awarded on Turnkey basis to M/s Bajel Projects Limited vide CE/PD&C, HVPNL, Panchkula office memo no. P.O. No. HDP-34/PD&C/EPC-D-17/PD&C/XenProjects (TL) dated 06.06.2022.
- C.4.2 The construction work of this project was completed and the loop-out section of the said line i.e. 220kV Sector-72 (HVPN) – Sector-15 (HVPN) Gurugram (8 Km) was charged on dated 04.12.2024.
- C.4.3 It is pertinent to mention here that commissioning of the line was approved for 05.09.2023 but the commissioning got delayed due to ROW issues in construction of the line. Commissioning of this line was very utmost priority in Gurugram area due to restrictions imposed by NGT in NCR area & to give relief in power cuts-imposed downtime.

**Agenda of 55<sup>th</sup> Protection Sub-Committee Meeting (20<sup>th</sup> December, 2024)**

- C.4.4 The line differential relay was earlier provided (additional) on 220kV Sector-72 (PG) – Sector-72 Gurugram line being very short line (200 mtr) through hard wired CT. However, C&R panels for the said line were provisioned for distance protection relay (Main-I and Main-II) with backup O/C + E/F and commissioned in the year 2011 both at PGCIL end and HVPNL end.
- C.4.5 The settings of distance protection relay (Main-I and Main-II) are available at NRPC website ([http://164.100.60.165/meetings/PCC/PCC55/HVPNL\\_Lilo.zip](http://164.100.60.165/meetings/PCC/PCC55/HVPNL_Lilo.zip)) and SLD of the LILO line is attached as **Annexure-C.II**.
- C.4.6 The protection scheme for 220kV Sector-72 (PG) – Sector-15 Gurugram line (8 km) was freezed in the year 2022 and accordingly distance protection relays viz ZIV & GE P442 as Main-I and Main-II protections already installed were finalized.
- C.4.7 However, as per latest Protection Philosophy approved this year by Northern Region Protection Committee; for very short line (less than 10 km), line differential protection with distance protection as backup (built in Main relay or standalone) shall be provided mandatorily as Main-I and Main-II.
- C.4.8 As the protection schemes was finalized by HVPNL much before NRPC's notification of latest protection philosophy, equipment hardware was already provided, and since the protection scheme being implemented by HVPNL technically fulfills all the basic protection requirements for the transmission line; HVPNL has requested to approve the same in relaxation to the protection philosophy in force.
- C.4.9 Further, HVPNL has undertaken that HVPNL will strictly adhere to the NRPC's protection Philosophy in all of its future transmission lines.

**Decision required from Forum:**

*Forum may approve the protection settings (available at - [http://164.100.60.165/meetings/PCC/PCC55/HVPNL\\_Lilo.zip](http://164.100.60.165/meetings/PCC/PCC55/HVPNL_Lilo.zip) ) after deliberation and may suggest changes, if any.*

**Agenda of 55<sup>th</sup> Protection Sub-Committee Meeting (20<sup>th</sup> December, 2024)**

**C.5. Approval of protection settings in compliance of IEGC 2023 (agenda by POWERGRID)**

C.5.1 POWERGRID has submitted that First Time Charging of following transmission lines/Bays/Transformer/Reactor have been done in the month of Nov-2024.

S. No	CASE ID	Application Month	Name of element	Owner	Voltage Level (in kV)	Bay No	Bay Type	Substation
1	1119-271	Oct - 2024	400kV Main Bay 427 of 400/220 kV, 500 MVA ICT-5 at Bikaner_2 (PBTSL)	PBTSL	400kV	427	Main Bay	Bikaner_2 (PBTSL)
2	1119-271	Oct - 2024	400kV Tie Bay 426 of 400/220 kV, 500 MVA ICT-5 and Future Line at Bikaner_2 (PBTSL)	PBTSL	400kV	426	Tie Bay	Bikaner_2 (PBTSL)
3	1119-271	Oct - 2024	220kV Main Bay 210 of 400/220 kV, 500 MVA ICT-5 at Bikaner_2 (PBTSL)	PBTSL	220kV	210	Main Bay	Bikaner_2 (PBTSL)
4	1119-300	Nov - 2024	220kV Main Bay 240(A210) of 220 kV Adani Renewable Energy Holding Four Ltd ckt-I at Fatehgarh_I I(PG)	POWER GRID	220kV	240(A210)	Main Bay	Fatehgarh_I I(PG)
5	1119-300	Nov - 2024	220kV Main Bay 239(A209) of 220 kV Adani Renewable Energy	POWER GRID	220kV	239(A209)	Main Bay	Fatehgarh_I I(PG)



**Agenda of 55<sup>th</sup> Protection Sub-Committee Meeting (20<sup>th</sup> December, 2024)**

			Holding Four Ltd ckt-II at Fatehgarh_I I(PG)					
6	1119 271	Oct - 2024	400/220/33 kV, 500 MVA MVA, 3-Phase, T & R, ICT - 5 at Bikaner_2 (PBTSL)	PBTSL	400/220/ 33kV	500 MVA	IC T	Bikaner_2 (PBTSL)

C.5.2 Further, as per protection setting procedure finalized in 75<sup>th</sup> NRPC meeting, utility has to get final approval of settings in PSC meeting, therefore, POWERGRID has put up the settings (available at NRPC website link <http://164.100.60.165/meetings/PCC/PCC55/POWERGRID.zip> ) for approval of Forum.

**Decision required from Forum:**

*Forum may approve the protection settings (available at <http://164.100.60.165/meetings/PCC/PCC55/POWERGRID.zip>) after deliberation and may suggest changes, if any.*

\*\*\*\*\*

**Members of Protection Sub-Committee (FY 24-25)**

S. No.	NRPC Member Organization	Designation	Email-ID
1	Member (GO&D), CEA	Director, NPC Division	<a href="mailto:skdotancea@nic.in">skdotancea@nic.in</a>
2	Member (PS), CEA	Chief Engineer, PSPA-I Division	<a href="mailto:i.sharan@nic.in">i.sharan@nic.in</a>
3	CTUIL	Sr.GM	<a href="mailto:schakraborty@powergrid.in">schakraborty@powergrid.in</a>
4	PGCIL	GM	<a href="mailto:gunjan.agrawal@powergrid.in">gunjan.agrawal@powergrid.in</a>
5	NLDC*	Executive Director	<a href="mailto:scsaxena@grid-india.in">scsaxena@grid-india.in</a>
6	NRLDC	CGM(SO)	<a href="mailto:somara.lakra@grid-india.in">somara.lakra@grid-india.in</a>
7	NTPC	GM(OS-NR)	<a href="mailto:dmandal@ntpc.co.in">dmandal@ntpc.co.in</a>
8	BBMB	Director (P&C)	<a href="mailto:dirpc@bbmb.nic.in">dirpc@bbmb.nic.in</a>
9	THDC*	Chief General Manager (EM-Design)	<a href="mailto:rrsemwal@thdc.co.in">rrsemwal@thdc.co.in</a>
10	SJVN	General Manager	<a href="mailto:sjvn.cso@sjvn.nic.in">sjvn.cso@sjvn.nic.in</a>
11	NHPC	General Manager (O&M)	<a href="mailto:hod-om-co@nhpc.nic.in">hod-om-co@nhpc.nic.in</a>
12	NPCIL*	Director (Finance), SO/F, TSU(E&I)	<a href="mailto:df@npcil.co.in">df@npcil.co.in</a> <a href="mailto:rajeshsharma@npcil.co.in">rajeshsharma@npcil.co.in</a>
13	Delhi SLDC	General Manager	<a href="mailto:gmsldc@delhisldc.org">gmsldc@delhisldc.org</a>
14	Haryana SLDC	Chief Engineer (SO&C)	<a href="mailto:cesocomml@hvpn.org.in">cesocomml@hvpn.org.in</a>
15	Rajasthan SLDC	Chief Engineer (LD)	<a href="mailto:ce.ld@rvpn.co.in">ce.ld@rvpn.co.in</a>
16	Uttar Pradesh SLDC	Superintending Engineer (R&A)	<a href="mailto:sera@upslcd.org">sera@upslcd.org</a>
17	Uttarakhand SLDC	Chief Engineer	<a href="mailto:anupam_singh@ptcul.org">anupam_singh@ptcul.org</a>
18	Punjab SLDC	Chief Engineer	<a href="mailto:ce-sldc@punjabslcd.org">ce-sldc@punjabslcd.org</a>
19	Himachal Pradesh SLDC	Chief Engineer	<a href="mailto:cehpsldc@gmail.com">cehpsldc@gmail.com</a>
20	DTL	AGM-Protection	<a href="mailto:bharatquijardtl@gmail.com">bharatquijardtl@gmail.com</a>
21	HVPNL	Chief Engineer (TS)	<a href="mailto:cetspkl@hvpn.org.in">cetspkl@hvpn.org.in</a>
22	RRVPNL	CE (M&P)	<a href="mailto:ce.mps@rvpn.co.in">ce.mps@rvpn.co.in</a>
23	UPPTCL*	Managing Director	<a href="mailto:md@upptcl.org">md@upptcl.org</a>
24	PTCUL	SE(T&C)	<a href="mailto:setandchld@gmail.com">setandchld@gmail.com</a>
25	PSTCL	Chief Engineer (P&M)	<a href="mailto:ce-pm@pstcl.org">ce-pm@pstcl.org</a>
26	HPPTCL*	Managing Director	<a href="mailto:md.tcl@hpmail.in">md.tcl@hpmail.in</a>
27	IPGCL	DGM (Protection)	<a href="mailto:arif.ipgcl@gmail.com">arif.ipgcl@gmail.com</a>
28	HPGCL	SE/M&T RGTPP	<a href="mailto:semt.rgtp@hpqcl.org.in">semt.rgtp@hpqcl.org.in</a>
29	RRVUNL*	CMD	<a href="mailto:cmd@rrvun.com">cmd@rrvun.com</a>
30	UPRVUNL	Chief Engineer, (L-2)	<a href="mailto:ce.ppm@uprvunl.org">ce.ppm@uprvunl.org</a>
31	UJVNL*	Managing Director	<a href="mailto:mdujvnl@ujvnl.com">mdujvnl@ujvnl.com</a>
32	HPPCL*	Managing Director	<a href="mailto:md@hppcl.in">md@hppcl.in</a>
33	PSPCL	Chief Engineer/GHTP	<a href="mailto:ce-ghtp@pspcl.in">ce-ghtp@pspcl.in</a>
34	UHBVN	Managing Director	<a href="mailto:md@uhbvn.org.in">md@uhbvn.org.in</a>
35	Jodhpur Vidyut Vitran Nigam Ltd.	Managing Director	<a href="mailto:MD.JDVVNL@RAJASTHAN.GOV.IN">MD.JDVVNL@RAJASTHAN.GOV.IN</a>
36	Paschimanchal Vidyut Vitaran Nigam Ltd.	Managing Director	<a href="mailto:md@pvvnl.org">md@pvvnl.org</a>
37	UPCL*	Managing Director	<a href="mailto:md@upcl.org">md@upcl.org</a>
38	HPSEB*	Managing Director	<a href="mailto:md@hpseb.in">md@hpseb.in</a>
39	Prayagraj Power Generation Co. Ltd.*	Head (Commercial & Regulatory), DGM - Elect	<a href="mailto:sanjay.bhargava@tatapower.com">sanjay.bhargava@tatapower.com</a> , <a href="mailto:dhananjay.singh@ppqcl.co.in">dhananjay.singh@ppqcl.co.in</a>
40	Aravali Power Company Pvt. Ltd*	CEO	<a href="mailto:brahmajiq@ntpc.co.in">brahmajiq@ntpc.co.in</a>
41	Apraava Energy Private Limited*	GM-Electrical	<a href="mailto:navin.chaturvedi@apraava.com">navin.chaturvedi@apraava.com</a>
42	Talwandi Sabo Power Ltd. *	COO	<a href="mailto:Vibhav.Agarwal@vedanta.co.in">Vibhav.Agarwal@vedanta.co.in</a>
43	Nabha Power Limited*	CEO	<a href="mailto:sk.narang@larsentoubro.com">sk.narang@larsentoubro.com</a>
44	MEIL Anpara Energy Ltd	COO & WTD, Executive Director	<a href="mailto:anandkumar.singh@meilanparapower.com">anandkumar.singh@meilanparapower.com</a> , <a href="mailto:arun.tholia@meilanparapower.com">arun.tholia@meilanparapower.com</a>
45	Rosa Power Supply Company Ltd	GM-ELECTRICAL	<a href="mailto:kesarinandan.pandey@relianceada.com">kesarinandan.pandey@relianceada.com</a>
46	Lalitpur Power Generation Company Ltd	Head of Maintenance, GM Electrical	<a href="mailto:alokkumar.ltp@lpgcl.com">alokkumar.ltp@lpgcl.com</a> , <a href="mailto:aupadhyay.ltp@lpgcl.com">aupadhyay.ltp@lpgcl.com</a>
47	MEJA Urja Nigam Ltd.	AGM-EMD	<a href="mailto:SPSPUNDIR@NTPC.CO.IN">SPSPUNDIR@NTPC.CO.IN</a>
48	Adani Power Rajasthan Limited*	COO, Thermal, O&M	<a href="mailto:javadeb.nanda@adani.com">javadeb.nanda@adani.com</a>
49	JSW Energy Ltd. (KWHEP)*	Head Regulatory & Power Sales	<a href="mailto:iyotiprakash.panda@jsw.in">iyotiprakash.panda@jsw.in</a>
50	TATA POWER RENEWABLE*	Zonal Head, NR	<a href="mailto:dhmahabale@tatapower.com">dhmahabale@tatapower.com</a>
51	UT of J&K*	Chief Engineer, JKPCCL	<a href="mailto:cejkpccl2@gmail.com">cejkpccl2@gmail.com</a>
52	UT of Ladakh*	Chief Engineer, LPDD	<a href="mailto:cepladakh@gmail.com">cepladakh@gmail.com</a>
53	UT of Chandigarh	Executive Engineer	<a href="mailto:elop2-chd@nic.in">elop2-chd@nic.in</a>
54	Noida Power Company Limited	Head – Power Purchase	<a href="mailto:ssrivastava@noidapower.com">ssrivastava@noidapower.com</a>
55	Fatehgarh Bhadla Transmission Limited	Head-Protection, AESL	<a href="mailto:Sunil.Raval@adani.com">Sunil.Raval@adani.com</a>
56	NTPC Vidyut Vyapar Nigam Ltd.	CEO	<a href="mailto:ceonvvn@ntpc.co.in">ceonvvn@ntpc.co.in</a>
57	ReNew Power Private Limited*	CEO	<a href="mailto:sumant@renew.com">sumant@renew.com</a>
58	NTPC Green Energy Limited*	CEO	<a href="mailto:rajivgupta@ntpc.co.in">rajivgupta@ntpc.co.in</a>
59	Azure Power India Pvt. Limited*	CEO	<a href="mailto:sunil.gupta@azurepower.com">sunil.gupta@azurepower.com</a>
60	Avaada Energy Private Limited*	CEO	<a href="mailto:kishor.nair@avaada.com">kishor.nair@avaada.com</a>
61	Adani Green Energy Limited	AVP	<a href="mailto:sanjay.bhatt@adani.com">sanjay.bhatt@adani.com</a>

\* Organizations from where nominations are not received for PSC, members of NRPC have been mentioned. Nomination for PSC forum may be sent at the earliest.

Status of action taken on decision 54<sup>th</sup> PSC meeting

S.N.	Agenda	Decision of 53 <sup>rd</sup> PSC	Status of action taken
A.3	Submission of protection performance indices along with reason and corrective action taken for indices less than unity to NRPC Secretariat on monthly basis (agenda by NRPC Secretariat)	i) Forum directed HPGCL to submit the protection performance indices from April, 2024 to October, 2024	HPGCL has not submitted indices yet.  HPGCL may submit the reason for non-submission of protection performance indices.
A.4	Annual protection audit plan for FY 2024-25 and third-party protection audit plan (agenda by NRPC Secretariat)	Third Party Protection Audit report is to be submitted by RPSCL, Adani Power Ltd, SEUPPTCL.  ADHPL was requested to update the current status of third-party protection audit. As per submitted plan, third party audit was scheduled to be done by September, 2024.	Audit report is awaited. RPSCL and UPSLDC may update.  No update received from ADHPL. ADHPL may apprise the current status.
A.6	Observations and Compliance of recommendations of protection audit (agenda by NRPC Secretariat)	THDC, UJVNL, RVUNL, UPSLDC and UPRVUNL were also requested to submit the compliance report of internal Protection audits.	Compliance report is awaited. THDC, UJVNL, RVUNL, UPSLDC and UPRVUNL may update.

Status of action taken on decision 54<sup>th</sup> PSC meeting

A.10	<p>Tripping of every transmission line whenever Broken Conductor Alarm on 220kV feeder and loss of VT (in any of phase) at 220kV bus is observed simultaneously (agenda by RVPN)</p>	<p>MS, NRPC stated to ask the comments of utilities on the proposal of RVPN via email and the same may be again discussed in the next PSC meeting based on received inputs.</p>	<p>An email dated 02.12.2024 were sent to all PSC members to send the comments. UPPTCL, LPGCL and NPCIL have submitted comments. Agenda has been taken in the 55<sup>th</sup> PSC meeting.</p>
A.13	<p>Review of protection setting of Thermal, Hydro, IBR based generations/HVDC and FACTS (agenda by NLDC)</p>	<p>1. Forum requested all generating members to share the inputs for protection settings for conventional generators.</p> <p>2. Forum directed NLDC to seek the inputs on protection philosophy of IBR based RE generations/HVDC and FACTS from RE generators, HVDC owners, NRLDC, other RPCs &amp; RLDCs and compile the received inputs. Accordingly, a meeting may be called by NRPC for discussion and philosophy may be finalized.</p>	<p>No information received from NLDC yet. NLDC may update.</p>

Status of action taken on decision 54<sup>th</sup> PSC meeting

A.33	Constitution of Protection System Analysis Group (PSAG) (agenda by NRPC Secretariat)	Forum approved the constitution of Protection System Analysis Group (PSAG) having members from NRPC, NPC, NLDC, NRLDC, PGCIL, NTPC and a Protection Expert from the region along with the entity under whose jurisdiction GD/GI occurred to analyse any critical or specific Grid Disturbances/Grid Incidents recommended by NRPC Secretariat and NRLDC.	PSAG is being constituted by NRPC Secretariat.
------	--	--	--

Status of performance indices report of November 2024		
S. No.	Utility	Status of Protection Performance Indices
1	PGCIL	Received (NR-1,
2	NTPC	
3	BBMB	
4	THDC	Received (Tehri,
5	SJVN	Received (Njhps, RHPS)
6	NHPC	Received
7	NPCIL	Received (RAP-5&6, RAP-3&4, NAP-1&2
8	Delhi SLDC	
9	Haryana SLDC	
10	Rajasthan SLDC	
11	Uttar Pradesh SLDC	Received (WUPPTCL
12	Uttarakhand SLDC	
13	Punjab SLDC	
14	Himachal Pradesh SLDC	
15	DTL	Received
16	HVPNL	Received
17	RRVNL	Received
18	UPPTCL	Received (All Zones)
19	PTCUL	Received
20	PSTCL	
21	HPPTCL	Received
22	IPGCL	Received (PPS-I, III)
23	HPGCL	
24	RRVUNL	Received
25	UPRVUNL	Received (DTPS Anpara
26	UJVNL	Received (Dharshu, Tiloth, Khodri, Chibro, Vyasi)
27	HPPCL	
28	PSPCL	Received (RSD, GHTP, GATP, GGSSTP)
29	HPSEBL	
30	Prayagraj Power Generation Co. Ltd.	Received
31	Aravali Power Company Pvt. Ltd	Received
32	Apraava Energy Private Limited	Received
33	Talwandi Sabo Power Ltd.	Received
34	Nabha Power Limited	Received
35	MEIL Anpara Energy Ltd	Received
36	Rosa Power Supply Company Ltd	Received
37	Lalitpur Power Generation Company Ltd	Received
38	MEJA Urja Nigam Ltd.	
39	Adani Power Rajasthan Limited	Received
40	JSW Energy Ltd. (KWHEP)	
41	AESL	Received (ATIL, ATSCl, BKTl, FBTL, GTL, HPTSL, MTSCl, OCBTl)
42	Tata Power Renewable Energy Ltd.	Received (TPGEL, TPREL, Tata Power Sourya)
43	UT of J&K	
44	UT of Ladakh	
45	UT of Chandigarh	
46	INDIGRID	Received
47	POWERLINK	
48	ADHPL	Received
49	Sekura Energy Limited	

**Reasons & Corrective actions taken by concerned utility for Performance Indices less than Unity- November 2024**

**PSPCL**

**Case-1 Tripping of 220 kV feeder GGSSTP to Gulal-1**

No. of unwanted operation-

**Reason for failure to operate** – Tripping in zone-2 due to carrier unhealthiness

**Corrective action taken**- Not received from utility.

**UPPTCL**

**Case-1 Tripping of 160MVA ICT-II at 220kV Substation Gajokhar (Prayagraj Zone)**

No. of correct operation-0

No. of unwanted operation-1

No. of operations failure to operate-0

**Reason for unwanted operation**- tripped in DC earth fault due to damaged control cable.

**Corrective action taken**- Attended.

**Case-2 Tripping of 400kV Fatehabad-Agra (PG) 400kV Fatehabad-Firozabad (Agra Zone)**

No. of correct operation-0

No. of unwanted operation-1

No. of operations failure to operate-0

**Reason for unwanted operation**- Due to relay malfunctioning.

**Corrective action taken**- Shutdown proposed for relay testing.

### **Case-3 Tripping of 400kV Fatehabad-Firozabad (Agra Zone)**

No. of correct operation-0

No. of unwanted operation-1

No. of operations failure to operate-0

**Reason for unwanted operation-** Due to relay malfunctioning.

**Corrective action taken-** Shutdown proposed for relay testing.

### **Case-4 Tripping of 400kV Panki- Rewa road line (Agra Zone)**

No. of correct operation-0

No. of unwanted operation-1

No. of operations failure to operate-0

**Reason for unwanted operation-** other end trip.

**Corrective action taken-**

### **RVPN**

#### **Case-1 220 KV Bus Bar Protection at 220KV GSS BALI on 03.11.2024**

No. of Unwanted operation – 6

**Reason of unwanted operation** – Spurious current observed in one PU.

**Corrective Action taken** – The problem had occurred on 02.05.2024 also, the CT core was changed at that time. Again, this incident happened on 03.11.2024, no justified reason for Bus bar protection operation could be found. It was thought that the particular PU may be defective, hence, the same has been replaced and the relay is under observation.



**Case-2 220/132 KV, 160 MVA TRF-II at 220 KV GSS SWAIMADHOPUR on 15.11.2024**

No. of Unwanted operation – 1

**Reason of unwanted operation** – Tripping occurred on Buchholz relay indication

**Corrective Action taken** – TCIV of NIFPES found in closed position, the same has been put in normal position.

**Case-3 220 KV BARMER - MPT LINE at Barmer on 24.11.2024**

No. of Unwanted operation – 1

**Reason of unwanted operation** – Due to defect in VT selection relay.

**Corrective Action taken** – VT selection relay defect rectified.

**SJVN (Rampur HPS)**

**Case-1 Stopping of 68.67 MW generating unit no. 5 of Rampur HPS on 23.11.2024.**

Number of unwanted operations -1

**Reason for unwanted operation** – Generating unit stopped due to o ring damaged causes major oil leakage observed in governor pipeline.

**Corrective action taken** – Damaged o ring was replaced.

**HPTSL (AESL)**

Case-1 Tripping of 220/132kV 160 MVA Power Transformer at Ranpur

Number of correct operation -1

Number of unwanted operation-1

**Reason for unwanted operation-** 160MVA Power transformer tripped on false operation during Tap changing operation.

**Corrective action taken-** not received from utility.

### **DTL**

**Case-1 Tripping of 315MVA ICT-IV (400/220kV) at 400kV S/s Bawana**

Number of correct operation -0

Number of unwanted operation-1

**Reason for unwanted operation-** Buchholz relay tripped during testing of pumps.

**Corrective action taken-** not received from utility.

## Status of Internal Protection Audit Plan for FY 2024 -25

S. No.	NRPC Member	Category	Status
1	PGCIL	Central Government owned Transmission Company	Received
2	NTPC	Central Generating Company	Received
3	BBMB		Received
4	THDC		Received
5	SJVN		Received
6	NHPC		Received
7	NPCIL		
8	Delhi SLDC	SLDC	
9	Haryana SLDC		
10	Rajasthan SLDC		
11	Uttar Pradesh SLDC		Vishnuprayag, WUPPTCL
12	Uttarakhand SLDC		
13	Punjab SLDC		
14	Himachal Pradesh SLDC		
15	DTL	State Transmission Utility	Received
16	HVPNL		Received
17	RRVNL		Received
18	UPPTCL		Received for Jhansi, Lucknow, Meerut, Gorakhpur, Prayagraj, Agra zone)
19	PTCUL		Received
20	PSTCL		Received
21	HPPTCL		Received
22	IPGCL		Received (PPCL-I,III)
23	HPGCL		
24	RRVUNL	State Generating Company	Received
25	UPRVUNL		Received (obra -B, Anpara-B,D switch yard, Harduganj-C,D,E))
26	UJVNL		Received (Khodri, Chibro, Vyasi, Dharasu , Tiloth)
27	HPPCL		
28	PSPCL	State Generating Company & State owned Distribution Company	Received (Ranjet sagar dam, GHTP, GGSSTP, GATP)
29	HPSEBL	Distribution company having Transmission connectivity ownership	
30	Prayagraj Power Generation Co. Ltd.	IPP having more than 1000 MW installed capacity	Received
31	Aravali Power Company Pvt. Ltd		Received
32	Apraava Energy Private Limited		Received
33	Talwandi Sabo Power Ltd.		
34	Nabha Power Limited		Received
35	MEIL Anpara Energy Ltd		Received
36	Rosa Power Supply Company Ltd		Received
37	Lalitpur Power Generation Company Ltd		Received
38	MEJA Urja Nigam Ltd.		
39	Adani Power Rajasthan Limited		Received
40	JSW Energy Ltd. (KWHEP)		Received
41	AESL	Other transmission licensee	Received (ATIL -400kV Mohindergarh S/s, OBTL, FBTL, MTSSL, ATSSL, HPTSL, BKTL, GTL)
42	Tata Power Renewable Energy Ltd.		Received (TPGEL, BTPSL)
43	UT of J&K	UT of Northern Region	
44	UT of Ladakh		
45	UT of Chandigarh		
46	INDIGRID		Received
47	ADHPL		Received
48	Sekura Energy Limited		

## Status of 3rd Party Protection Audit Plan

S. No.	NRPC Member	Category	Status	Schedule submitted as per utility	Present Status Completed (yes/no)
1	PGCIL	Central Government owned Transmission Company	Received (7 S/s of NR-1, 1 S/s of NR-2, 4 S/s of Nr-3)	By Jan 2025	
2	NTPC	Central Generating Company	Received (Singrauli, Rihand, Unchahar, Dadri, Dadri Gas, Auraiya Gas, Faridabad Gas, Anta Gas Power Station)	By Oct 2028	
3	BBMB		Received (Tanda)	By 17.07.2025	
4	THDC		Received	March 2026-Tehri, F.Y. 2025-26- Koteswar	
5	SJVN		Received	Nov-Dec 2025 for RHPS, Nov 24- March 25 for NJHPS	
6	NHPC		Received	FY-2025-26	
7	NPCIL				
8	Delhi SLDC				
9	Haryana SLDC				
10	Rajasthan SLDC				
11	Uttar Pradesh SLDC		SEUPPTCL	Conducted (Oct 2024)	Report is to be submitted
12	Uttarakhand SLDC				
13	Punjab SLDC				
14	Himachal Pradesh SLDC				
15	DTL	State Transmission Utility	Received		
16	HV/PNL				
17	RRV/PNL				
18	UPPTCL				
19	PTCUL		Received	By Jan 2025	
20	PSTCL				
21	HPPTCL				
22	IPGCL	State Generating Company	Received (PPS-III)	FY 25-26	
23	HPGCL				
24	RRVUNL				
25	UPRVUNL		Received (Obra-B)	2026-27	
26	UJVNL				
27	HPPCL				
28	PSPCL		State Generating Company & State owned Distribution Company	Received (GHTP)	Dec. 2025
			Received (GATP)	May 2025	
			GGSSTP		
			RSD/ Sahapur Kandi		
29	HPSEBL	Distribution company having Transmission connectivity ownership			
30	Prayagraj Power Generation Co. Ltd.	IPP having more than 1000 MW installed capacity	Received	Dec-24	
31	Aravali Power Company Pvt. Ltd				
32	Apraava Energy Private Limited		Received	By May, 2025	
33	Talwandi Sabo Power Ltd.				
34	Nabha Power Limited		Received	Dec-24	
35	MEIL Anpara Energy Ltd		Received	Dec-24	
36	Rosa Power Supply Company Ltd		Conducted	By 30.09.2024	Report is to be submitted
37	Lalitpur Power Generation Company Ltd		Conducted	26.03.2024	
38	MEJA Urja Nigam Ltd.				
39	Adani Power Rajasthan Limited		Conducted	November, 2024	
40	JSW Energy Ltd. (KW/HEP)	Received	December 2024 to March 2025		
41	AESL	Other Transmission Licensee	Received (ATIL -400kV Mohindergarh S/s.)	400kV Mohindergarh SS- Q2 , FY 2025-26	
			Received (OBTL)	OBTL-Q1 , FY 2025-26	
			Received (FBTL)	FBTL-Q3 , FY 2025-26	
			Received (MTSCL)	MTSCL-Q4 , FY 2025-26	
			Received (ATSCL)	ATSCL-Q1 , FY 2026-27	
			Received (HPTSL)	HPTSL- Q2 , FY 2026-27	
			Received (BKTL)	BKTL-Q3 , FY 2026-27	
			Received (GTL)	GTL- Q3 & Q4, FY 2026-27	
42	Tata Power Renewable Energy Ltd.	IPP having less than 1000 MW installed capacity (alphabetical rotational basis)			
43	UT of J&K	UT of Northern Region			
44	UT of Ladakh				
45	UT of Chandigarh				
46	INDIGRID		Received (NRSS 29)	FY 24-25	
47	ADHPL		Received	30.09.2024	May update current status
48	Sekura Energy Limited				

\* Revised Schedule

## Status of Internal Protection Audit Plan for FY 2025 -26

S. No.	NRPC Member	Category	Status
1	PGCIL	Central Government owned Transmission Company	
2	NTPC	Central Generating Company	Received
3	BBMB		
4	THDC		Received (Tehri)
5	SJVN		Received (NJHPS)
6	NHPC		
7	NPCIL		
8	Delhi SLDC		SLDC
9	Haryana SLDC		
10	Rajasthan SLDC		
11	Uttar Pradesh SLDC	Received (Jaypee Vishnuprayag, WUPPTCL)	
12	Uttarakhand SLDC		
13	Punjab SLDC		
14	Himachal Pradesh SLDC		
15	DTL	State Transmission Utility	Received
16	HVPNL		Received
17	RRVPNL		Received
18	UPPTCL		Received (All zones)
19	PTCUL		
20	PSTCL		
21	HPPTCL		Received
22	IPGCL	State Generating Company	Received (PPS-III, I)
23	HPGCL		
24	RRVUNL		
25	UPRVUNL		
26	UJVNL		Received (Dharashu, Tiloth)
27	HPPCL		
28	PSPCL	State Generating Company & State owned Distribution Company	Received (GHTP, GGSSTP, GATP, RSD)
29	HPSEBL	Distribution company having Transmission connectivity ownership	
30	Prayagraj Power Generation Co. Ltd.	IPP having more than 1000 MW installed capacity	Received
31	Aravali Power Company Pvt. Ltd		
32	Apraava Energy Private Limited		
33	Talwandi Sabo Power Ltd.		
34	Nabha Power Limited		
35	MEIL Anpara Energy Ltd		
36	Rosa Power Supply Company Ltd		Received
37	Lalitpur Power Generation Company Ltd		Received
38	MEJA Urja Nigam Ltd.		
39	Adani Power Rajasthan Limited		
40	JSW Energy Ltd. (KWHEP)		
41	AESL	Other transmission licensee	
42	Tata Power Renewable Energy Ltd.		
43	UT of J&K	UT of Northern Region	
44	UT of Ladakh		
45	UT of Chandigarh		
46	INDIGRID		
47	ADHPL		
48	Sekura Energy Limited		

**LAITPUR POWER GENERATION COMPANY LIMITED**  
**(3X660MW GENERATING STATION WITH 765kV/220kV SWITCHYARD)**

**INTERNAL PROTECTION AUDIT REPORT**  
**CONDUCTED IN OCT-NOV 2024 AS PER IEGC INTERNAL PROTECTION AUDIT COMPLIANCE**  
**FY-2024-25**

**FINAL REPORT RELEASED ON 30<sup>TH</sup> NOV 2024**



TEAM ELECTRICAL  
Internal Protection Audit



**Bajaj Energy Ltd, 5X660MW LPGCL, Lalitpur, Uttar Pradesh**

**Station- 765/220kV LPGCL Switchyard**

**Audit Year**

**Document Rev**

Document No- LPGCL-EMD/DP/36

2024

00

**TITLE: Internal Protection Audit of 765kV & 220kV Switchyard**

Sr No	Input Required	Details of Substation
1	Name of Sub-station	765/220KV LPGCL Switchyard
2	Date of first commissioning	2015
3	Type of Bus Switching Scheme	765KV-One -and -half & 220kV-Double bus with transfer bus
4	Whether SLD collected or Not	Yes

**Internal Audit Team**

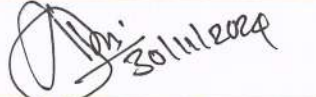
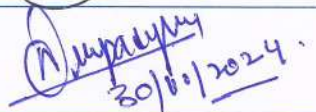
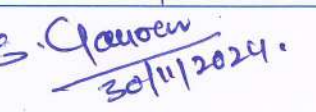
Name	Designation	Role & Responsibility	Signature
Mr. A.N SAR	<b>Chief Executive Officer</b>	Final Approval	 30/11/2024 AN SAR
Mr. Alok Kumar Srivastava	<b>Head- Maintenance</b>	Final Reviewer	 30/11/2024
Mr. Abhimanyu Upadhyay	<b>GM and Head-Electrical</b>	Reviewer	 30/11/2024
Mr. Sushant Gaurav	<b>AGM-Electrical</b>	Lead Protection Audit	 30/11/2024
Mr. Ritesh Rai	<b>Sr. Engineer</b>	Field Auditor	 Ritesh Rai 30/11/2024





**Bajaj Energy Ltd, 3X660MW LPGCL, Lalitpur, Uttar Pradesh**

**Station- 765/220kV LPGCL Switchyard**

**Audit Year**

**Document Rev**

Document No- LPGCL-EMD/DP/36

2024

00

**TITLE: Internal Protection Audit of 765kV & 220kV Switchyard**

5	LBB Protection of 765kV Ckt#02 is in out of service as per logic & scheme, logic is configured as per 708-Tie LBB. The Binary input configuration which are using for IN/OUT not as per scheme. IN-OUT switch actually in IN position but in relay it was configured for LBB inhibit.	765kV Line #02	P141 LBB	Binary input and output configuration to be corrected in PSL logic and setting files which shall be done in shutdown.	Open	
6	STUB protection found disable in 765kV Ckt #02 21M2 Relay which should be enable as per NRPC guidelines.	765kV Line #02	P545	STUB protection made Enable as per NRPC guideline.	Closed	During relay testing, it might be possible to make it OFF to check the other Zone protection. Now protection is enabled.
7	In line Reactor 1, LBB protection logic was not considered for tripping, and it was configured in reactor differential protection (P642_87R-1). LBB protection should be taken separately with DC changeover scheme.	765kV LR#01	P642 87R1	PSL logic to be modified and configuration to be downloaded into relays. This will be done in shutdown or bypassing LBB and Bus bar protection.	Open	As per approved scheme, LBB protection has been considered in 87R1 relay. Protection should be enabled & it should send DT & Tripping to Main & TIE CB.
8	In line Reactor 2, LBB protection logic was not considered for tripping, and it was configured in reactor differential protection (P642_87R-1). LBB protection should be taken separately with DC changeover scheme.	765kV LR#02	P642 87R1	PSL logic to be modified and configuration to be downloaded into relays. This will be done in shutdown or bypassing LBB and Bus bar protection.	Open	As per approved scheme, LBB protection has been considered in 87R1 relay. Protection should be enabled & it should send DT & Tripping to Main & TIE CB.





**Bajaj Energy Ltd, 3X660MW LPGCL, Lalitpur, Uttar Pradesh**

**Station- 765/220kV LPGCL Switchyard**

**Audit Year**

**Document Rev**

Document No- LPGCL-EMD/DP/36

2024

00

**TITLE: Internal Protection Audit of 765kV & 220kV Switchyard**

9	ICT #02 LBB Current and 87OH primary current value not matching because of CT ration of LBB set on 1000/1A Instead of 2000/1A.	765kV ICT #02	P141 LBB	CT ratio to be corrected by passing LBB and bus bar protection.	Open	Loop in-loop out ratio should be same. 87OH and LBB relay ratio should be same as same CT core & ratio are used for both relays.
10	ICT #01 P141 LBB relay and Bus Bar PUA (P743) & PUB (P743) relay measured primary current value is not matching as CT connection and setting checked in relay and yard also, everything found ok as per scheme.	765kV ICT #01	P743 PUA & PUB	Relay calibration is required with secondary injection kit which will be performed in bus bar shutdown.	Open	During Audit 50-60A differential current observed in bus bar relay. After detail investigation, discrepancy observed in ICT-2 bay.
11	DT Send CH-01 ckt for Agra line#01 to be verify for 21M2, LBB, PUA & PUB2 relay protection operated, as per bay-709 CRP as build and old drawing no-3269PP660-S-04, DT send via CH-01 when protection operated at 21M2, LBB, PUA & PUB2 output not connected with DT send signal.	765kV Line #01	CRP Drawing	DT send logic to be verified during line shutdown.	Open	The observation came during scheme drawing checking. In scheme one loop is missing, same need to be verified during shutdown.
12	Adopted & connected CT ratio in Bay-706 CRP drawing No-3269PP552-S-27 shows 1000/1A for 706 CTT in Core-1, Core 2 & Core-3 and 705 CTDA Core-1, Core 2 & Core-3. But actual 2000/1A for 706 CTT in Core-1, Core 2 & Core-3 and 705 CTDA Core-1, Core 2 & Core-3 are connected.	765kV Bay-706	CRP Drawing	As built drawing to be corrected as per physical CT connection	Open	As built drawing was not as per actual CT connection.

**Bajaj Energy Ltd, 3X660MW LPGCL, Lalitpur, Uttar Pradesh****Station- 765/220kV LPGCL Switchyard****Audit Year****Document Rev**

Document No- LPGCL-EMD/DP/36

2024

00

**TITLE: Internal Protection Audit of 765kV & 220kV Switchyard**

13	Fault locator setting was found wrong and not matching with line parameters. Fault locator parameters (RFLO) changed in 21M1 Relays of 220kV all Lines and 765kV Agra Ckt #02.	220kV all lines & 765kV ckt #02	REL670, P444 & P545	Fault locator setting modified as per line parameters.	Closed	
14	Bay 206 PUB 89A Isolator Close feedback input not getting High.	220kV Bay-206	P743 PUB	The isolator status to be provided in bus bar as per scheme which could be possible only either bus bar shutdown or by passing bus bar protection.	Open	Bus Bar Main-1 & Main-2 Current are not showing same due to Isolator status missing in PU.
15	Bay 203 PUB 89B Isolator Close feedback input not getting High.	220kV Bay-203	P743 PUB	The isolator status to be provided in bus bar as per scheme which could be possible only either bus bar shutdown or by passing bus bar protection.	Open	Bus Bar Main-1 & Main-2 Current are not showing same due to Isolator status missing in PU.
16	Bay 203 PUB 89C Isolator Open feedback input not getting High.	220kV Bay-203	P743 PUB	The isolator status to be provided in bus bar as per scheme which could be possible only either bus bar shutdown or by passing bus bar protection.	Open	Bus Bar Main-1 & Main-2 Current are not showing same due to Isolator status missing in PU.
17	Bay 202 PUB 89C Isolator Open feedback input not getting High.	220kV Bay-202	P743 PUB	The isolator status to be provided in bus bar as per scheme which could be possible only either bus bar shutdown or by passing bus bar protection.	Open	Bus Bar Main-1 & Main-2 Current are not showing same due to Isolator status missing in PU.



**Bajaj Energy Ltd, 3X660MW LPGCL, Lalitpur, Uttar Pradesh**

**Station- 765/220kV LPGCL Switchyard**

**Audit Year**

**Document Rev**

Document No- LPGCL-EMD/DP/36

2024

00

**TITLE: Internal Protection Audit of 765kV & 220kV Switchyard**

18	Broken conductor protection was enabled for tripping in 220kV kalyanpura Ckt #01 & ckt#02. It should be Alarm as per NRPC guideline.	220kV kalyanpura Ckt #01 & ckt#02.	P444 21M2	BRC Protection trip made disable and kept for DR purpose only.	Closed	As per NRPC, BRC should be considered trip only in case of radial feeder to avoid transformer single phasing.
19	DR Configuration of pre-fault time, post fault time, DR time & post retriggering setting all line changed except Agra Ckt#01.	220kV all lines & 765kV ckt #02	REL670, P444 & P545	For Viewing main & tie CB status in single DR, Pre fault kept 0.5 Sec, Post fault kept 3.5 Sec and total fault duration kept-4 Sec.	Closed	As per NRPC guidelines, Pre-Fault-0.5Sec Post fault-2.5 Sec Total Fault-3 Sec.
20	Over current Protection was enabled in 220kV Kalyanpura Ckt #01 M12 Relay. It should be disable as per NRPC guideline.	220kV Bay-202	P444 21M2	O/C protection made disable.	Closed	As per NRPC guidelines, over current protection to be made disable for 220KV and above lines.
21	Over current Protection was enabled in 220kV Kalyanpura Ckt #01 21M1 Relay. It should be disable as per NRPC guideline.	220kV Bay-202	REL670	O/C protection made disable.	Closed	As per NRPC guidelines, over current protection to be made disable for 220KV and above lines.
22	Over current Protection was enabled in 220kV Kalyanpura Ckt #02 M12 Relay. It should be disable as per NRPC guideline.	220kV Bay-203	P444 21M2	O/C protection made disable.	Closed	As per NRPC guidelines, over current protection to be made disable for 220KV and above lines.
23	Over current Protection was enabled in 220kV Kalyanpura Ckt #02 21M1 Relay. It should be disable as per NRPC guideline.	220kV Bay-203	REL670	O/C protection made disable.	Closed	As per NRPC guidelines, over current protection to be made disable for 220KV and above lines.
24	Over current Protection was enabled in 220kV Dunara Ckt 21M1 Relay. It should be disable as per NRPC guideline.	220kV Dunara Line	REL670	O/C protection made disable.	Closed	As per NRPC guidelines, over current protection to be made disable for 220KV and above lines.



**Bajaj Energy Ltd, 3X660MW LPGCL, Lalitpur, Uttar Pradesh**

**Station- 765/220kV LPGCL Switchyard**

**Audit Year**

**Document Rev**

Document No- LPGCL-EMD/DP/36

2024

00

**TITLE: Internal Protection Audit of 765kV & 220kV Switchyard**

25	Over current Protection was enabled in 220kV Dunara Ckt 21M2 Relay. It should be disable as per NRPC guideline.	220kV Bay-208	P444 21M2	O/C protection made disable.	Closed	As per NRPC guidelines, over current protection to be made disable for 220KV and above lines.
26	Over current Protection was enabled in 220kV Babina Ckt 21M1 Relay. It should be disable as per NRPC guideline.	220kV Babina Line	REL670	O/C protection made disable.	Closed	As per NRPC guidelines, over current protection to be made disable for 220KV and above lines.
27	Over current Protection was enabled in 220kV Babina Ckt 21M2Relay.It should be disable as per NRPC guideline.	220kV Bay-207	P444 21M2	O/C protection made disable.	Closed	As per NRPC guidelines, over current protection to be made disable for 220KV and above lines.
28	Over voltage setting in dunara circuit found P-N in measurement mode but set voltage of V>1 & V>2 was PH-PH.	220kV Dunara Line	P444	Voltage measurement mode changed from P-N to PH-PH	Closed	
29	Some 765kV & 220kV relay Communication with Scada is not stabilised.	SCADA		Ethernet port not working properly which need to be replaced.	Open	
30	In 220kV Lines of Babina & Dunara Ckt REL670 Relay communication issue with SCADA persisting, no any signal is reporting to Scada from above mention Relays.	SCADA		Relay is communicating with SAS, only issue in ICD file. ICD files are not matching as per SAS configuration.	Open	
31	During relay testing of ST #01 it was observed that the REF CT link was found shorted at panel end which was bypassing the REF current to relay.	ST #01	P141 OC/EF Relay	REF CT link made operational & REF protection taken in service	Closed	During commissioning it might be bypassed to check the circulating current in secondary.



**Bajaj Energy Ltd, 3X660MW LPGCL, Lalitpur, Uttar Pradesh**

**Station- 765/220kV LPGCL Switchyard**

**Audit Year**

**Document Rev**

Document No- LPGCL-EMD/DP/36

2024

00

**TITLE: Internal Protection Audit of 765kV & 220kV Switchyard**

## 2) Instrument Transformer

### A.1 Current transformer (CT-765kV)

Location of CT : Bay 701 MCTG

Ratio Test Date: 20.03.2015

Balance Testing (Tan-delta , IR & Winding Resistance ) date : 28.11.2023

Sr No	R-PH (Sl. No-37994004132)	Core I	Core II	Core III	Core IV	Core V	Core VI
i	Ratio Adopted	Spare	1000/1A	1000/1A	NA	NA	NA
ii	Ratio measured	Spare	999.80	999.80	NA	NA	NA
iii	error calculated	Spare	-0.21	-0.20	NA	NA	NA
iv	Knee point voltage	Spare	NA	NA	NA	NA	NA
Sr No	Y-PH (Sl. No-37994004120)	Core I	Core II	Core III	Core IV	Core V	Core VI
i	Ratio Adopted	Spare	1000/1A	1000/1A	NA	NA	NA
ii	Ratio measured	Spare	999.80	999.80	NA	NA	NA
iii	error calculated	Spare	-0.18	-0.19	NA	NA	NA
iv	Knee point voltage	Spare	NA	NA	NA	NA	NA
Sr No	B-PH (Sl. No-37994004131)	Core I	Core II	Core III	Core IV	Core V	Core VI
i	Ratio Adopted	Spare	1000/1A	1000/1A	NA	NA	NA
ii	Ratio measured	Spare	999.80	999.80	NA	NA	NA
iii	error calculated	Spare	-0.19	-0.21	NA	NA	NA
iv	Knee point voltage	Spare	NA	NA	NA	NA	NA



**Bajaj Energy Ltd, 3X660MW LPGCL, Lalitpur, Uttar Pradesh**

**Station- 765/220kV LPGCL Switchyard**

**Audit Year**

**Document Rev**

Document No- LPGCL-EMD/DP/36

2024

00

**TITLE: Internal Protection Audit of 765kV & 220kV Switchyard**

## A.2 Current transformer (CT-765kV)

Location of CT: Bay 701 PCTG

Ratio Test Date: 03.02.2015

Balance Testing (Tan-delta, IR & Winding Resistance) date: 24.11.2023

Sr No	R-PH (SI. No-37994002370)	Core I	Core II	Core III	Core IV	Core V	Core VI
i	Ratio Adopted	1000/1A	2000/1A	2000/1A	Spare	3000/1A	3000/1A
ii	Ratio measured	999.80	1999.60	1999.60	Spare	1999.6	1999.6
iii	error calculated	-0.51	-0.14	-0.28	Spare	-0.24	-0.16
iv	Knee point voltage	KVP 1000V at 120mA	KVP 2000V at 30mA	NA	NA	KVP 3000V at 20mA	KVP 3000V at 20mA
Sr No	Y-PH (SI. No-37994002161)	Core I	Core II	Core III	Core IV	Core V	Core VI
i	Ratio Adopted	1000/1A	2000/1A	2000/1A	Spare	3000/1A	3000/1A
ii	Ratio measured	999.80	1999.60	1999.60	Spare	1999.6	1999.6
iii	error calculated	-0.19	-0.14	-0.22	Spare	-0.14	-0.13
iv	Knee point voltage	KVP 1000V at 120mA	KVP 2000V at 30mA	NA	NA	KVP 3000V at 20mA	KVP 3000V at 20mA
Sr No	B-PH (SI. No-37994002367)	Core I	Core II	Core III	Core IV	Core V	Core VI
i	Ratio Adopted	1000/1A	2000/1A	2000/1A	Spare	3000/1A	3000/1A
ii	Ratio measured	999.80	1999.60	1999.60	Spare	1999.6	1999.6
iii	error calculated	-0.17	-0.2	-0.3	Spare	-0.15	-0.13
iv	Knee point voltage	KVP 1000V at 120mA	KVP 2000V at 30mA	NA	NA	KVP 3000V at 20mA	KVP 3000V at 20mA



**Bajaj Energy Ltd, 3X660MW LPGCL, Lalitpur, Uttar Pradesh**

**Station- 765/220kV LPGCL Switchyard**

**Audit Year**

**Document Rev**

Document No- LPGCL-EMD/DP/36

2024

00

**TITLE: Internal Protection Audit of 765kV & 220kV Switchyard**

### A.3 Current transformer (CT-765kV)

Location of CT: Bay 702 CTDA

Ratio Test Date: 30.01.2015

Balance Testing (Tan-delta, IR & Winding Resistance) date : 29.11.2023

Sr No	R-PH (Sl. No-37994002355)	Core I	Core II	Core III	Core IV	Core V	Core VI
i	Ratio Adopted	2000/1A	2000/1A	2000/1A	Spare	Spare	Spare
ii	Ratio measured	1999.60	1999.60	1999.60	Spare	Spare	Spare
iii	error calculated	-0.37	-0.28	-0.21	Spare	Spare	Spare
iv	Knee point voltage	KVP 2000V at 30mA	KVP 2000V at 30mA	NA	NA	Spare	Spare
Sr No	Y-PH (Sl. No-37994002353)	Core I	Core II	Core III	Core IV	Core V	Core VI
i	Ratio Adopted	2000/1A	2000/1A	2000/1A	Spare	Spare	Spare
ii	Ratio measured	1999.60	1999.60	1999.60	Spare	Spare	Spare
iii	error calculated	-0.29	-0.43	-0.33	Spare	Spare	Spare
iv	Knee point voltage	KVP 2000V at 30mA	KVP 2000V at 30mA	NA	NA	Spare	Spare
Sr No	B-PH (Sl. No-37994002366)	Core I	Core II	Core III	Core IV	Core V	Core VI
i	Ratio Adopted	2000/1A	2000/1A	2000/1A	Spare	Spare	Spare
ii	Ratio measured	1999.60	1999.60	1999.60	Spare	Spare	Spare
iii	error calculated	-0.39	-0.25	-0.24	Spare	Spare	Spare
iv	Knee point voltage	KVP 2000V at 30mA	KVP 2000V at 30mA	NA	NA	Spare	Spare



**Bajaj Energy Ltd, 3X660MW LPGCL, Lalitpur, Uttar Pradesh**

**Station- 765/220kV LPGCL Switchyard**

**Audit Year**

**Document Rev**

Document No- LPGCL-EMD/DP/36

2024

00

**TITLE: Internal Protection Audit of 765kV & 220kV Switchyard**

#### A.4 Current transformer (CT-765kV)

Location of CT: Bay 702 CTDB

Ratio Test Date: 04.02.2015

Balance Testing (Tan-delta, IR & Winding Resistance ) date : 29.11.2023

Sr No	R-PH(SI. No-37994003472)	Core I	Core II	Core III	Core IV	Core V	Core VI
i	Ratio Adopted	1000/1A	2000/1A	2000/1A	Spare	Spare	Spare
ii	Ratio measured	999.80	1999.60	1999.60	Spare	Spare	Spare
iii	error calculated	-0.27	-0.26	-0.22	Spare	Spare	Spare
iv	Knee point voltage	KVP 1000V at 120mA	KVP 2000V at 30mA	NA	NA	Spare	Spare
Sr No	Y-PH(SI. No-37994003725)	Core I	Core II	Core III	Core IV	Core V	Core VI
i	Ratio Adopted	1000/1A	2000/1A	2000/1A	Spare	Spare	Spare
ii	Ratio measured	999.80	1999.60	1999.60	Spare	Spare	Spare
iii	error calculated	-0.27	-0.25	-0.21	Spare	Spare	Spare
iv	Knee point voltage	KVP 1000V at 120mA	KVP 2000V at 30mA	NA	NA	Spare	Spare
Sr No	B-PH(SI. No-37994003635)	Core I	Core II	Core III	Core IV	Core V	Core VI
i	Ratio Adopted	1000/1A	2000/1A	2000/1A	Spare	Spare	Spare
ii	Ratio measured	999.80	1999.60	1999.60	Spare	Spare	Spare
iii	error calculated	-0.28	-0.25	-0.22	Spare	Spare	Spare
iv	Knee point voltage	KVP 1000V at 120mA	KVP 2000V at 30mA	NA	NA	Spare	Spare





**Bajaj Energy Ltd, 3X660MW LPGCL, Lalitpur, Uttar Pradesh**

**Station- 765/220kV LPGCL Switchyard**

**Audit Year**

**Document Rev**

Document No- LPGCL-EMD/DP/36

2024

00

**TITLE: Internal Protection Audit of 765kV & 220kV Switchyard**

### A.5 Current transformer (CT-765kV)

Location of CT : Bay 703 PCTT

Ratio Test Date : 02.02.2015

Balance Testing (Tan-delta , IR & Winding Resistance ) date : 29.11.2023

Sr No	R-PH(SI. No-37994003178)	Core I	Core II	Core III	Core IV	Core V	Core VI
i	Ratio Adopted	2000/1A	2000/1A	2000/1A	Spare	3000/1A	3000/1A
ii	Ratio measured	1999.60	1999.60	1999.60	Spare	1999.6	1999.6
iii	error calculated	-0.26	-0.25	-0.25	Spare	-0.24	-0.24
iv	Knee point voltage	KVP 2000V at 30mA	KVP 2000V at 30mA	NA	NA	KVP 3000V at 20mA	KVP 3000V at 20mA
Sr No	Y-PH(SI. No-37994003473)	Core I	Core II	Core III	Core IV	Core V	Core VI
i	Ratio Adopted	2000/1A	2000/1A	2000/1A	Spare	3000/1A	3000/1A
ii	Ratio measured	1999.60	1999.60	1999.60	Spare	1999.6	1999.6
iii	error calculated	-0.22	-0.24	-0.21	Spare	-0.24	-0.23
iv	Knee point voltage	KVP 2000V at 30mA	KVP 2000V at 30mA	NA	NA	KVP 3000V at 20mA	KVP 3000V at 20mA
Sr No	B-PH(SI. No-37994003721)	Core I	Core II	Core III	Core IV	Core V	Core VI
i	Ratio Adopted	2000/1A	2000/1A	2000/1A	Spare	3000/1A	3000/1A
ii	Ratio measured	1999.60	1999.60	1999.60	Spare	1999.6	1999.6
iii	error calculated	-0.22	-0.22	-0.19	Spare	-0.21	-0.21
iv	Knee point voltage	KVP 2000V at 30mA	KVP 2000V at 30mA	NA	NA	KVP 3000V at 20mA	KVP 3000V at 20mA



**Bajaj Energy Ltd, 3X660MW LPGCL, Lalitpur, Uttar Pradesh**

**Station- 765/220kV LPGCL Switchyard**

**Audit Year**

**Document Rev**

Document No- LPGCL-EMD/DP/36

2024

00

**TITLE: Internal Protection Audit of 765kV & 220kV Switchyard**

## A.6 Current transformer (CT-765kV)

Location of CT : Bay 703 MCTT

Ratio Test Date : 03.06.2015

Balance Testing (Tan-delta , IR & Winding Resistance ) date : 29.11.2023

Sr No	R-PH(SI. No-37994004210)	Core I	Core II	Core III	Core IV	Core V	Core VI
i	Ratio Adopted	250/1A	250/1A	NA	NA	NA	NA
ii	Ratio measured	250	250	NA	NA	NA	NA
iii	error calculated	-0.45	-0.29	NA	NA	NA	NA
iv	Knee point voltage	NA	NA	NA	NA	NA	NA
Sr No	Y-PH(SI. No-37994004205)	Core I	Core II	Core III	Core IV	Core V	Core VI
i	Ratio Adopted	250/1A	250/1A	NA	NA	NA	NA
ii	Ratio measured	250	250	NA	NA	NA	NA
iii	error calculated	-0.44	-0.46	NA	NA	NA	NA
iv	Knee point voltage	NA	NA	NA	NA	NA	NA
Sr No	B-PH(SI. No-37994004208)	Core I	Core II	Core III	Core IV	Core V	Core VI
i	Ratio Adopted	250/1A	250/1A	NA	NA	NA	NA
ii	Ratio measured	250	250	NA	NA	NA	NA
iii	error calculated	-0.32	-0.29	NA	NA	NA	NA
iv	Knee point voltage	NA	NA	NA	NA	NA	NA



**Bajaj Energy Ltd, 3X660MW LPGCL, Lalitpur, Uttar Pradesh**

**Station- 765/220kV LPGCL Switchyard**

**Audit Year**

**Document Rev**

Document No- LPGCL-EMD/DP/36

2024

00

**TITLE: Internal Protection Audit of 765kV & 220kV Switchyard**

### A.7 Current transformer (CT-765kV)

Location of CT : Bay 704 CTR

Ratio Test Date : 06.02.2015

Balance Testing (Tan-delta , IR & Winding Resistance ) date : 06.06.2023

Sr No	R-PH(SI. No-37994003274)	Core I	Core II	Core III	Core IV	Core V	Core VI
i	Ratio Adopted	2000/1A	2000/1A	2000/1A	Spare	3000/1A	3000/1A
ii	Ratio measured	1999.60	1999.60	1999.60	Spare	1999.6	1999.6
iii	error calculated	-0.27	-0.21	-0.22	Spare	-0.24	-0.24
iv	Knee point voltage	KVP 2000V at 30mA	KVP 2000V at 30mA	NA	NA	KVP 3000V at 20mA	KVP 3000V at 20mA
Sr No	Y-PH(SI. No-37994002352)	Core I	Core II	Core III	Core IV	Core V	Core VI
i	Ratio Adopted	2000/1A	2000/1A	2000/1A	Spare	3000/1A	3000/1A
ii	Ratio measured	1999.60	1999.60	1999.60	Spare	1999.6	1999.6
iii	error calculated	-0.24	-0.26	-0.18	Spare	-0.26	-0.24
iv	Knee point voltage	KVP 2000V at 30mA	KVP 2000V at 30mA	NA	NA	KVP 3000V at 20mA	KVP 3000V at 20mA
Sr No	B-PH(SI. No-37994002376)	Core I	Core II	Core III	Core IV	Core V	Core VI
i	Ratio Adopted	2000/1A	2000/1A	2000/1A	Spare	3000/1A	3000/1A
ii	Ratio measured	1999.60	1999.60	1999.60	Spare	1999.6	1999.6
iii	error calculated	-0.21	-0.26	-0.3	Spare	-0.24	-0.22
iv	Knee point voltage	KVP 2000V at 30mA	KVP 2000V at 30mA	NA	NA	KVP 3000V at 20mA	KVP 3000V at 20mA



**Bajaj Energy Ltd, 3X660MW LPGCL, Lalitpur, Uttar Pradesh**

**Station- 765/220kV LPGCL Switchyard**

**Audit Year**

**Document Rev**

Document No- LPGCL-EMD/DP/36

2024

00

**TITLE: Internal Protection Audit of 765kV & 220kV Switchyard**

### A.8 Current transformer (CT-765kV)

Location of CT : Bay 705 CTDA

Ratio Test Date : 06.02.2015

Balance Testing (Tan-delta , IR & Winding Resistance ) date : 07.01.2023

Sr No	R-PH(SI. No-37994002361)	Core I	Core II	Core III	Core IV	Core V	Core VI
i	Ratio Adopted	2000/1A	2000/1A	2000/1A	Spare	Spare	Spare
ii	Ratio measured	1999.60	1999.60	1999.60	Spare	Spare	Spare
iii	error calculated	-0.37	-0.37	-0.25	Spare	Spare	Spare
iv	Knee point voltage	KVP 2000V at 30mA	KVP 2000V at 30mA	NA	NA	Spare	Spare
Sr No	Y-PH(SI. No-37994002354)	Core I	Core II	Core III	Core IV	Core V	Core VI
i	Ratio Adopted	2000/1A	2000/1A	2000/1A	Spare	Spare	Spare
ii	Ratio measured	1999.60	1999.60	1999.60	Spare	Spare	Spare
iii	error calculated	-0.16	-0.14	-0.21	Spare	Spare	Spare
iv	Knee point voltage	KVP 2000V at 30mA	KVP 2000V at 30mA	NA	NA	Spare	Spare
Sr No	B-PH(SI. No-37994002377)	Core I	Core II	Core III	Core IV	Core V	Core VI
i	Ratio Adopted	2000/1A	2000/1A	2000/1A	Spare	Spare	Spare
ii	Ratio measured	1999.60	1999.60	1999.60	Spare	Spare	Spare
iii	error calculated	-0.4	-0.22	-0.2	Spare	Spare	Spare
iv	Knee point voltage	KVP 2000V at 30mA	KVP 2000V at 30mA	NA	NA	Spare	Spare



**Bajaj Energy Ltd, 3X660MW LPGCL, Lalitpur, Uttar Pradesh**

**Station- 765/220kV LPGCL Switchyard**

**Audit Year**

**Document Rev**

Document No- LPGCL-EMD/DP/36

2024

00

**TITLE: Internal Protection Audit of 765kV & 220kV Switchyard**

## A.9 Current transformer (CT-765kV)

Location of CT : Bay 705 CTDB

Ratio Test Date : 07.02.2015

Balance Testing (Tan-delta , IR & Winding Resistance ) date : 07.01.2023

Sr No	R-PH(SI. No-37994003173)	Core I	Core II	Core III	Core IV	Core V	Core VI
i	Ratio Adopted	2000/1A	2000/1A	2000/1A	Spare	Spare	Spare
ii	Ratio measured	1999.60	1999.60	1999.60	Spare	Spare	Spare
iii	error calculated	-0.3	-0.31	-0.24	Spare	Spare	Spare
iv	Knee point voltage	KVP 2000V at 30mA	KVP 2000V at 30mA	NA	NA	Spare	Spare
Sr No	Y-PH(SI. No-37994003471)	Core I	Core II	Core III	Core IV	Core V	Core VI
i	Ratio Adopted	2000/1A	2000/1A	2000/1A	Spare	Spare	Spare
ii	Ratio measured	1999.60	1999.60	1999.60	Spare	Spare	Spare
iii	error calculated	-0.31	-0.3	-0.37	Spare	Spare	Spare
iv	Knee point voltage	KVP 2000V at 30mA	KVP 2000V at 30mA	NA	NA	Spare	Spare
Sr No	B-PH(SI. No-37994003634)	Core I	Core II	Core III	Core IV	Core V	Core VI
i	Ratio Adopted	2000/1A	2000/1A	2000/1A	Spare	Spare	Spare
ii	Ratio measured	1999.60	1999.60	1999.60	Spare	Spare	Spare
iii	error calculated	-0.26	-0.26	-0.22	Spare	Spare	Spare
iv	Knee point voltage	KVP 2000V at 30mA	KVP 2000V at 30mA	NA	NA	Spare	Spare



**Bajaj Energy Ltd, 3X660MW LPGCL, Lalitpur, Uttar Pradesh**

**Station- 765/220kV LPGCL Switchyard**

**Audit Year**

**Document Rev**

Document No- LPGCL-EMD/DP/36

2024

00

**TITLE: Internal Protection Audit of 765kV & 220kV Switchyard**

### A.10 Current transformer (CT-765kV)

Location of CT : Bay 706 PCTT

Ratio Test Date : 09.02.2015

Balance Testing (Tan-delta , IR & Winding Resistance ) date : 07.01.2023

Sr No	R-PH(SI. No-37994003726)	Core I	Core II	Core III	Core IV	Core V	Core VI
i	Ratio Adopted	2000/1A	2000/1A	2000/1A	Spare	3000/1A	3000/1A
ii	Ratio measured	1999.60	1999.60	1999.60	Spare	1999.6	1999.6
iii	error calculated	-0.26	-0.26	-0.23	Spare	-0.25	-0.25
iv	Knee point voltage	KVP 2000V at 30mA	KVP 2000V at 30mA	NA	NA	KVP 3000V at 20mA	KVP 3000V at 20mA
Sr No	Y-PH(SI. No-37994002365)	Core I	Core II	Core III	Core IV	Core V	Core VI
i	Ratio Adopted	2000/1A	2000/1A	2000/1A	Spare	3000/1A	3000/1A
ii	Ratio measured	1999.60	1999.60	1999.60	Spare	1999.6	1999.6
iii	error calculated	-0.38	-0.36	-0.33	Spare	-0.31	-0.32
iv	Knee point voltage	KVP 2000V at 30mA	KVP 2000V at 30mA	NA	NA	KVP 3000V at 20mA	KVP 3000V at 20mA
Sr No	B-PH(SI. No-37994003633)	Core I	Core II	Core III	Core IV	Core V	Core VI
i	Ratio Adopted	2000/1A	2000/1A	2000/1A	Spare	3000/1A	3000/1A
ii	Ratio measured	1999.60	1999.60	1999.60	Spare	1999.6	1999.6
iii	error calculated	-0.27	-0.24	-0.21	Spare	-0.23	-0.19
iv	Knee point voltage	KVP 2000V at 30mA	KVP 2000V at 30mA	NA	NA	KVP 3000V at 20mA	KVP 3000V at 20mA



**Bajaj Energy Ltd, 3X660MW LPGCL, Lalitpur, Uttar Pradesh**

**Station- 765/220kV LPGCL Switchyard**

**Audit Year**

**Document Rev**

Document No- LPGCL-EMD/DP/36

2024

00

**TITLE: Internal Protection Audit of 765kV & 220kV Switchyard**

## A.11 Current transformer (CT-765kV)

Location of CT : Bay 706 MCTT

Ratio Test Date : 20.05.2015

Balance Testing (Tan-delta , IR & Winding Resistance ) date : 07.01.2023

Sr No	R-PH(SI. No-37994004207)	Core I	Core II	Core III	Core IV	Core V	Core VI
i	Ratio Adopted	250/1A	250/1A	NA	NA	NA	NA
ii	Ratio measured	250	250	NA	NA	NA	NA
iii	error calculated	-0.29	-0.43	NA	NA	NA	NA
iv	Knee point voltage	NA	NA	NA	NA	NA	NA
Sr No	Y-PH(SI. No-37994004206)	Core I	Core II	Core III	Core IV	Core V	Core VI
i	Ratio Adopted	250/1A	250/1A	NA	NA	NA	NA
ii	Ratio measured	250	250	NA	NA	NA	NA
iii	error calculated	-0.34	-0.2	NA	NA	NA	NA
iv	Knee point voltage	NA	NA	NA	NA	NA	NA
Sr No	B-PH(SI. No-37994004209)	Core I	Core II	Core III	Core IV	Core V	Core VI
i	Ratio Adopted	250/1A	250/1A	NA	NA	NA	NA
ii	Ratio measured	250	250	NA	NA	NA	NA
iii	error calculated	-0.4	-0.27	NA	NA	NA	NA
iv	Knee point voltage	NA	NA	NA	NA	NA	NA



**Bajaj Energy Ltd, 3X660MW LPGCL, Lalitpur, Uttar Pradesh**

**Station- 765/220kV LPGCL Switchyard**

**Audit Year**

**Document Rev**

Document No- LPGCL-EMD/DP/36

2024

00

**TITLE: Internal Protection Audit of 765kV & 220kV Switchyard**

## A.12 Current transformer (CT-765kV)

Location of CT : Bay 707 MCTG

Ratio Test Date : 14.07.2015

Balance Testing (Tan-delta , IR & Winding Resistance ) date : 06.02.2023

Sr No	R-PH(SI. No-37994004122)	Core I	Core II	Core III	Core IV	Core V	Core VI
i	Ratio Adopted	Spare	1000/1A	1000/1A	NA	NA	NA
ii	Ratio measured	Spare	999.80	999.80	NA	NA	NA
iii	error calculated	Spare	-0.16	-0.15	NA	NA	NA
iv	Knee point voltage	Spare	NA	NA	NA	NA	NA
Sr No	Y-PH(SI. No-37994004123)	Core I	Core II	Core III	Core IV	Core V	Core VI
i	Ratio Adopted	Spare	1000/1A	1000/1A	NA	NA	NA
ii	Ratio measured	Spare	999.80	999.80	NA	NA	NA
iii	error calculated	Spare	-0.18	-0.16	NA	NA	NA
iv	Knee point voltage	Spare	NA	NA	NA	NA	NA
Sr No	B-PH(SI. No-37994004134)	Core I	Core II	Core III	Core IV	Core V	Core VI
i	Ratio Adopted	Spare	1000/1A	1000/1A	NA	NA	NA
ii	Ratio measured	Spare	999.80	999.80	NA	NA	NA
iii	error calculated	Spare	-0.18	-0.18	NA	NA	NA
iv	Knee point voltage	Spare	NA	NA	NA	NA	NA





**Bajaj Energy Ltd, 3X660MW LPGCL, Lalitpur, Uttar Pradesh**

**Station- 765/220kV LPGCL Switchyard**

**Audit Year**

**Document Rev**

Document No- LPGCL-EMD/DP/36

2024

00

**TITLE: Internal Protection Audit of 765kV & 220kV Switchyard**

### A.13 Current transformer (CT-765kV)

Location of CT : Bay 707 PCTG

Ratio Test Date : 04.05.2015

Balance Testing (Tan-delta , IR & Winding Resistance ) date : 09.02.2023

Sr No	R-PH(SI. No-37994003723)	Core I	Core II	Core III	Core IV	Core V	Core VI
i	Ratio Adopted	1000/1A	2000/1A	2000/1A	Spare	3000/1A	3000/1A
ii	Ratio measured	999.80	1999.60	1999.60	Spare	1999.6	1999.6
iii	error calculated	-0.21	-0.2	-0.28	Spare	-0.2	-0.2
iv	Knee point voltage	KVP 1000V at 120mA	KVP 2000V at 30mA	NA	NA	KVP 3000V at 20mA	KVP 3000V at 20mA
Sr No	Y-PH(SI. No-37994003474)	Core I	Core II	Core III	Core IV	Core V	Core VI
i	Ratio Adopted	1000/1A	2000/1A	2000/1A	Spare	3000/1A	3000/1A
ii	Ratio measured	999.80	1999.60	1999.60	Spare	1999.6	1999.6
iii	error calculated	-0.2	-0.19	-0.22	Spare	-0.17	-0.16
iv	Knee point voltage	KVP 1000V at 120mA	KVP 2000V at 30mA	NA	NA	KVP 3000V at 20mA	KVP 3000V at 20mA
Sr No	B-PH(SI. No-37994003470)	Core I	Core II	Core III	Core IV	Core V	Core VI
i	Ratio Adopted	1000/1A	2000/1A	2000/1A	Spare	3000/1A	3000/1A
ii	Ratio measured	999.80	1999.60	1999.60	Spare	1999.6	1999.6
iii	error calculated	-0.18	-0.18	-0.3	Spare	-0.17	-0.16
iv	Knee point voltage	KVP 1000V at 120mA	KVP 2000V at 30mA	NA	NA	KVP 3000V at 20mA	KVP 3000V at 20mA



**Bajaj Energy Ltd, 3X660MW LPGCL, Lalitpur, Uttar Pradesh**

**Station- 765/220kV LPGCL Switchyard**

**Audit Year**

**Document Rev**

Document No- LPGCL-EMD/DP/36

2024

00

**TITLE: Internal Protection Audit of 765kV & 220kV Switchyard**

### A.14 Current transformer (CT-765kV)

Location of CT : Bay 708 CTDA

Ratio Test Date : 15.05.2015

Balance Testing (Tan-delta , IR & Winding Resistance ) date : 09.02.2023

Sr No	R-PH(SI. No-37994003200)	Core I	Core II	Core III	Core IV	Core V	Core VI
i	Ratio Adopted	3000/1A	3000/1A	3000/1A	Spare	Spare	Spare
ii	Ratio measured	1699.60	1699.60	1699.60	Spare	Spare	Spare
iii	error calculated	-0.21	-0.15	-0.16	Spare	Spare	Spare
iv	Knee point voltage	KVP 3000V at 20mA	KVP 3000V at 20mA	NA	NA	Spare	Spare
Sr No	Y-PH(SI. No-37994002854)	Core I	Core II	Core III	Core IV	Core V	Core VI
i	Ratio Adopted	3000/1A	3000/1A	3000/1A	Spare	Spare	Spare
ii	Ratio measured	1699.60	1699.60	1699.60	Spare	Spare	Spare
iii	error calculated	-0.19	-0.2	-0.16	Spare	Spare	Spare
iv	Knee point voltage	KVP 3000V at 20mA	KVP 3000V at 20mA	NA	NA	Spare	Spare
Sr No	B-PH(SI. No-37994002856)	Core I	Core II	Core III	Core IV	Core V	Core VI
i	Ratio Adopted	3000/1A	3000/1A	3000/1A	Spare	Spare	Spare
ii	Ratio measured	1699.60	1699.60	1699.60	Spare	Spare	Spare
iii	error calculated	-0.22	-0.22	-0.23	Spare	Spare	Spare
iv	Knee point voltage	KVP 3000V at 20mA	KVP 3000V at 20mA	NA	NA	Spare	Spare



**Bajaj Energy Ltd, 3X660MW LPGCL, Lalitpur, Uttar Pradesh**

**Station- 765/220kV LPGCL Switchyard**

**Audit Year**

**Document Rev**

Document No- LPGCL-EMD/DP/36

2024

00

**TITLE: Internal Protection Audit of 765kV & 220kV Switchyard**

### A.15 Current transformer (CT-765kV)

Location of CT : Bay 708 CTDB

Ratio Test Date : 05.05.2015

Balance Testing (Tan-delta , IR & Winding Resistance ) date : 10.02.2023

Sr No	R-PH(SI. No-37994003202)	Core I	Core II	Core III	Core IV	Core V	Core VI
i	Ratio Adopted	1000/1A	2000/1A	2000/1A	Spare	Spare	Spare
ii	Ratio measured	999.8	1799.60	1799	Spare	Spare	Spare
iii	error calculated	-0.24	-0.21	-0.17	Spare	Spare	Spare
iv	Knee point voltage	KVP 1000V at 120mA	KVP 2000V at 30mA	NA	NA	Spare	Spare
Sr No	Y-PH(SI. No-37994002855)	Core I	Core II	Core III	Core IV	Core V	Core VI
i	Ratio Adopted	1000/1A	2000/1A	2000/1A	Spare	Spare	Spare
ii	Ratio measured	999.8	1799.60	1799.60	Spare	Spare	Spare
iii	error calculated	-0.21	-0.17	-0.15	Spare	Spare	Spare
iv	Knee point voltage	KVP 1000V at 120mA	KVP 2000V at 30mA	NA	NA	Spare	Spare
Sr No	B-PH(SI. No-37994003176)	Core I	Core II	Core III	Core IV	Core V	Core VI
i	Ratio Adopted	1000/1A	2000/1A	2000/1A	Spare	Spare	Spare
ii	Ratio measured	999.8	1799.60	1799.60	Spare	Spare	Spare
iii	error calculated	-0.22	-0.17	-0.12	Spare	Spare	Spare
iv	Knee point voltage	KVP 1000V at 120mA	KVP 2000V at 30mA	NA	NA	Spare	Spare



**Bajaj Energy Ltd, 3X660MW LPGCL, Lalitpur, Uttar Pradesh**

**Station- 765/220kV LPGCL Switchyard**

**Audit Year**

**Document Rev**

Document No- LPGCL-EMD/DP/36

2024

00

**TITLE: Internal Protection Audit of 765kV & 220kV Switchyard**

### A.16 Current transformer (CT-765kV)

Location of CT : Bay 709 PCTL

Ratio Test Date : 20.06.2015

Balance Testing (Tan-delta , IR & Winding Resistance ) date : 03.03.2021

Sr No	R-PH(SI. No-37994003118)	Core I	Core II	Core III	Core IV	Core V	Core VI
i	Ratio Adopted	3000/1A	3000/1A	3000/1A	Spare	3000/1A	3000/1A
ii	Ratio measured	1999.60	1999.60	1999.60	Spare	1999.60	1999.60
iii	error calculated	-0.29	-0.28	-0.29	Spare	-0.26	-0.25
iv	Knee point voltage	KVP 3000V at 20mA	KVP 3000V at 20mA	NA	NA	KVP 3000V at 20mA	KVP 3000V at 20mA
Sr No	Y-PH(SI. No-37994003177)	Core I	Core II	Core III	Core IV	Core I	Core II
i	Ratio Adopted	3000/1A	3000/1A	3000/1A	Spare	3000/1A	3000/1A
ii	Ratio measured	1999.60	1999.60	1999.60	Spare	1999.60	1999.60
iii	error calculated	-0.23	-0.21	-0.18	Spare	-0.21	-0.21
iv	Knee point voltage	KVP 3000V at 20mA	KVP 3000V at 20mA	NA	NA	KVP 3000V at 20mA	KVP 3000V at 20mA
Sr No	B-PH(SI. No-37994007246)	Core I	Core II	Core III	Core IV	Core I	Core II
i	Ratio Adopted	3000/1A	3000/1A	3000/1A	Spare	3000/1A	3000/1A
ii	Ratio measured	1999.60	1999.60	1999.60	Spare	1999.60	1999.60
iii	error calculated	-0.18	-0.18	-0.16	Spare	-0.17	-0.16
iv	Knee point voltage	KVP 3000V at 20mA	KVP 3000V at 20mA	NA	NA	KVP 3000V at 20mA	KVP 3000V at 20mA



**Bajaj Energy Ltd, 3X660MW LPGCL, Lalitpur, Uttar Pradesh**

**Station- 765/220kV LPGCL Switchyard**

**Audit Year**

**Document Rev**

Document No- LPGCL-EMD/DP/36

2024

00

**TITLE: Internal Protection Audit of 765kV & 220kV Switchyard**

## A.17 Current transformer (CT-765kV)

Location of CT : Bay 709 MCTL

Ratio Test Date : 13.07.2015

Balance Testing (Tan-delta , IR & Winding Resistance ) date : 26.11.2020

Sr No	R-PH(SI. No-37994004119)	Core I	Core II	Core III	Core IV	Core V	Core VI
i	Ratio Adopted	2000/1A	2000/1A	Spare	NA	NA	NA
ii	Ratio measured	1599.60	1599.60	Spare	NA	NA	NA
iii	error calculated	-0.17	-0.14	Spare	NA	NA	NA
iv	Knee point voltage	NA	NA	Spare	NA	NA	NA
Sr No	Y-PH(SI. No-37994004128)	Core I	Core II	Core III	Core IV	Core V	Core VI
i	Ratio Adopted	2000/1A	2000/1A	Spare	NA	NA	NA
ii	Ratio measured	1599.60	1599.60	Spare	NA	NA	NA
iii	error calculated	-0.17	-0.16	Spare	NA	NA	NA
iv	Knee point voltage	NA	NA	Spare	NA	NA	NA
Sr No	B-PH(SI. No-37994004125)	Core I	Core II	Core III	Core IV	Core V	Core VI
i	Ratio Adopted	2000/1A	2000/1A	Spare	NA	NA	NA
ii	Ratio measured	1599.60	1599.60	Spare	NA	NA	NA
iii	error calculated	-0.14	-0.13	Spare	NA	NA	NA
iv	Knee point voltage	NA	NA	Spare	NA	NA	NA



**Bajaj Energy Ltd, 3X660MW LPGCL, Lalitpur, Uttar Pradesh**

**Station- 765/220kV LPGCL Switchyard**

**Audit Year**

**Document Rev**

Document No- LPGCL-EMD/DP/36

2024

00

**TITLE: Internal Protection Audit of 765kV & 220kV Switchyard**

## A.18 Current transformer (CT-765kV)

Location of CT : Bay 710 MCTG

Ratio Test Date : 13.07.2015

Balance Testing (Tan-delta , IR & Winding Resistance ) date : 05.01.2023

Sr No	R-PH(SI. No-37994004126)	Core I	Core II	Core III	Core IV	Core V	Core VI
i	Ratio Adopted	Spare	1000/1A	1000/1A	NA	NA	NA
ii	Ratio measured	Spare	999.80	999.80	NA	NA	NA
iii	error calculated	Spare	-0.21	-0.21	NA	NA	NA
iv	Knee point voltage	Spare	NA	NA	NA	NA	NA
Sr No	Y-PH(SI. No-37994004129)	Core I	Core II	Core III	Core IV	Core V	Core VI
i	Ratio Adopted	Spare	1000/1A	1000/1A	NA	NA	NA
ii	Ratio measured	Spare	999.80	999.80	NA	NA	NA
iii	error calculated	Spare	-0.21	-0.21	NA	NA	NA
iv	Knee point voltage	Spare	NA	NA	NA	NA	NA
Sr No	B-PH(SI. No-37994004121)	Core I	Core II	Core III	Core IV	Core V	Core VI
i	Ratio Adopted	Spare	1000/1A	1000/1A	NA	NA	NA
ii	Ratio measured	Spare	999.80	999.80	NA	NA	NA
iii	error calculated	Spare	-0.2	-0.21	NA	NA	NA
iv	Knee point voltage	Spare	NA	NA	NA	NA	NA



**Bajaj Energy Ltd, 3X660MW LPGCL, Lalitpur, Uttar Pradesh**

**Station- 765/220kV LPGCL Switchyard**

**Audit Year**

**Document Rev**

Document No- LPGCL-EMD/DP/36

2024

00

**TITLE: Internal Protection Audit of 765kV & 220kV Switchyard**

### A.19 Current transformer (CT-765kV)

Location of CT : Bay 710 PCTG

Ratio Test Date : 06.05.2015

Balance Testing (Tan-delta , IR & Winding Resistance ) date : 04.01.2023

Sr No	R-PH(SI. No-37994003120)	Core I	Core II	Core III	Core IV	Core V	Core VI
i	Ratio Adopted	1000/1A	2000/1A	2000/1A	Spare	3000/1A	3000/1A
ii	Ratio measured	999.80	1999.60	1999.60	Spare	1999.6	1999.6
iii	error calculated	-0.19	-0.2	-0.16	Spare	-0.13	-0.16
iv	Knee point voltage	KVP 1000V at 120mA	KVP 2000V at 30mA	NA	NA	KVP 3000V at 20mA	KVP 3000V at 20mA
Sr No	Y-PH(SI. No-37994003117)	Core I	Core II	Core III	Core IV	Core V	Core VI
i	Ratio Adopted	1000/1A	2000/1A	2000/1A	Spare	3000/1A	3000/1A
ii	Ratio measured	999.80	1999.60	1999.60	Spare	1999.6	1999.6
iii	error calculated	-0.23	-0.22	-0.16	Spare	-0.18	-0.18
iv	Knee point voltage	KVP 1000V at 120mA	KVP 2000V at 30mA	NA	NA	KVP 3000V at 20mA	KVP 3000V at 20mA
Sr No	B-PH(SI. No-37994003172)	Core I	Core II	Core III	Core IV	Core V	Core VI
i	Ratio Adopted	1000/1A	2000/1A	2000/1A	Spare	3000/1A	3000/1A
ii	Ratio measured	999.80	1999.60	1999.60	Spare	1999.6	1999.6
iii	error calculated	-0.25	-0.24	-0.18	Spare	-0.19	-0.12
iv	Knee point voltage	KVP 1000V at 120mA	KVP 2000V at 30mA	NA	NA	KVP 3000V at 20mA	KVP 3000V at 20mA



**Bajaj Energy Ltd, 3X660MW LPGCL, Lalitpur, Uttar Pradesh**

**Station- 765/220kV LPGCL Switchyard**

**Audit Year**

**Document Rev**

Document No- LPGCL-EMD/DP/36

2024

00

**TITLE: Internal Protection Audit of 765kV & 220kV Switchyard**

### A.20 Current transformer (CT-765kV)

Location of CT : Bay 711 CTDA

Ratio Test Date : 12.05.2015

Balance Testing (Tan-delta , IR & Winding Resistance ) date : 06.01.2023

Sr No	R-PH(SI. No-37994003199)	Core I	Core II	Core III	Core IV	Core V	Core VI
i	Ratio Adopted	3000/1A	3000/1A	3000/1A	Spare	Spare	Spare
ii	Ratio measured	1999.60	1999.60	1999.60	Spare	Spare	Spare
iii	error calculated	-0.25	-0.27	-0.21	Spare	Spare	Spare
iv	Knee point voltage	KVP 3000V at 20mA	KVP 3000V at 20mA	NA	NA	Spare	Spare
Sr No	Y-PH(SI. No-37994002362)	Core I	Core II	Core III	Core IV	Core V	Core VI
i	Ratio Adopted	3000/1A	3000/1A	3000/1A	Spare	Spare	Spare
ii	Ratio measured	1999.60	1999.60	1999.60	Spare	Spare	Spare
iii	error calculated	-0.22	-0.2	-0.19	Spare	Spare	Spare
iv	Knee point voltage	KVP 3000V at 20mA	KVP 3000V at 20mA	NA	NA	Spare	Spare
Sr No	B-PH(SI. No-37994003201)	Core I	Core II	Core III	Core IV	Core V	Core VI
i	Ratio Adopted	3000/1A	3000/1A	3000/1A	Spare	Spare	Spare
ii	Ratio measured	1999.60	1999.60	1999.60	Spare	Spare	Spare
iii	error calculated	-0.25	-0.24	-0.24	Spare	Spare	Spare
iv	Knee point voltage	KVP 3000V at 20mA	KVP 3000V at 20mA	NA	NA	Spare	Spare





**Bajaj Energy Ltd, 3X660MW LPGCL, Lalitpur, Uttar Pradesh**

**Station- 765/220kV LPGCL Switchyard**

**Audit Year**

**Document Rev**

Document No- LPGCL-EMD/DP/36

2024

00

**TITLE: Internal Protection Audit of 765kV & 220kV Switchyard**

### A.21 Current transformer (CT-765kV)

Location of CT : Bay 711 CTDB

Ratio Test Date : 11.05.2015

Balance Testing (Tan-delta , IR & Winding Resistance ) date : 06.01.2023

Sr No	R-PH(SI. No-37994002328)	Core I	Core II	Core III	Core IV	Core V	Core VI
i	Ratio Adopted	1000/1A	2000/1A	2000/1A	Spare	Spare	Spare
ii	Ratio measured	999.80	1999.60	1999.60	Spare	Spare	Spare
iii	error calculated	-0.26	-0.23	-0.27	Spare	Spare	Spare
iv	Knee point voltage	KVP 1000V at 120mA	KVP 2000V at 30mA	NA	NA	Spare	Spare
Sr No	Y-PH(SI. No-37994003179)	Core I	Core II	Core III	Core IV	Core V	Core VI
i	Ratio Adopted	1000/1A	2000/1A	2000/1A	Spare	Spare	Spare
ii	Ratio measured	999.80	1999.60	1999.60	Spare	Spare	Spare
iii	error calculated	-0.2	-0.19	-0.15	Spare	Spare	Spare
iv	Knee point voltage	KVP 1000V at 120mA	KVP 2000V at 30mA	NA	NA	Spare	Spare
Sr No	B-PH(SI. No-37994003724)	Core I	Core II	Core III	Core IV	Core V	Core VI
i	Ratio Adopted	1000/1A	2000/1A	2000/1A	Spare	Spare	Spare
ii	Ratio measured	999.80	1999.60	1999.60	Spare	Spare	Spare
iii	error calculated	-0.23	-0.25	-0.18	Spare	Spare	Spare
iv	Knee point voltage	KVP 1000V at 120mA	KVP 2000V at 30mA	NA	NA	Spare	Spare



**Bajaj Energy Ltd, 3X660MW LPGCL, Lalitpur, Uttar Pradesh**

**Station- 765/220kV LPGCL Switchyard**

**Audit Year**

**Document Rev**

Document No- LPGCL-EMD/DP/36

2024

00

**TITLE: Internal Protection Audit of 765kV & 220kV Switchyard**

## A.22 Current transformer (CT-765kV)

Location of CT : Bay 712 PCTL

Ratio Test Date : 14.06.2015

Balance Testing (Tan-delta , IR & Winding Resistance ) date : 23.01.2021

Sr No	R-PH(SI. No-37994007245)	Core I	Core II	Core III	Core IV	Core V	Core VI
i	Ratio Adopted	3000/1A	3000/1A	3000/1A	Spare	3000/1A	3000/1A
ii	Ratio measured	1999.60	1999.60	1999.60	Spare	1999.60	1999.60
iii	error calculated	-0.24	-0.23	-0.19	Spare	-0.22	-0.22
iv	Knee point voltage	KVP 3000V at 20mA	KVP 3000V at 20mA	NA	NA	KVP 3000V at 20mA	KVP 3000V at 20mA
Sr No	Y-PH(SI. No-37994002368)	Core I	Core II	Core III	Core IV	Core I	Core II
i	Ratio Adopted	3000/1A	3000/1A	3000/1A	Spare	3000/1A	3000/1A
ii	Ratio measured	1999.60	1999.60	1999.60	Spare	1999.60	1999.60
iii	error calculated	-0.26	-0.26	-0.25	Spare	-0.23	-0.25
iv	Knee point voltage	KVP 3000V at 20mA	KVP 3000V at 20mA	NA	NA	KVP 3000V at 20mA	KVP 3000V at 20mA
Sr No	B-PH(SI. No-37994002373)	Core I	Core II	Core III	Core IV	Core I	Core II
i	Ratio Adopted	3000/1A	3000/1A	3000/1A	Spare	3000/1A	3000/1A
ii	Ratio measured	1999.60	1999.60	1999.60	Spare	1999.60	1999.60
iii	error calculated	-0.11	-0.11	-0.14	Spare	-0.12	-0.1
iv	Knee point voltage	KVP 3000V at 20mA	KVP 3000V at 20mA	NA	NA	KVP 3000V at 20mA	KVP 3000V at 20mA



**Bajaj Energy Ltd, 3X660MW LPGCL, Lalitpur, Uttar Pradesh**

**Station- 765/220kV LPGCL Switchyard**

**Audit Year**

**Document Rev**

Document No- LPGCL-EMD/DP/36

2024

00

**TITLE: Internal Protection Audit of 765kV & 220kV Switchyard**

### A.23 Current transformer (CT-765kV)

Location of CT : Bay 712 MCTL

Ratio Test Date : 11.07.2015

Balance Testing (Tan-delta , IR & Winding Resistance ) date : 25.01.2021

Sr No	R-PH(SI. No-37994004130)	Core I	Core II	Core III	Core IV	Core V	Core VI
i	Ratio Adopted	2000/1A	2000/1A	Spare	NA	NA	NA
ii	Ratio measured	1599.60	1599.60	Spare	NA	NA	NA
iii	error calculated	-0.13	-0.13	Spare	NA	NA	NA
iv	Knee point voltage	NA	NA	Spare	NA	NA	NA
Sr No	Y-PH(SI. No-37994004127)	Core I	Core II	Core III	Core IV	Core V	Core VI
i	Ratio Adopted	2000/1A	2000/1A	Spare	NA	NA	NA
ii	Ratio measured	1599.60	1599.60	Spare	NA	NA	NA
iii	error calculated	-0.18	-0.17	Spare	NA	NA	NA
iv	Knee point voltage	NA	NA	Spare	NA	NA	NA
Sr No	B-PH(SI. No-37994004133)	Core I	Core II	Core III	Core IV	Core V	Core VI
i	Ratio Adopted	2000/1A	2000/1A	Spare	NA	NA	NA
ii	Ratio measured	1599.60	1599.60	Spare	NA	NA	NA
iii	error calculated	-0.17	-0.15	Spare	NA	NA	NA
iv	Knee point voltage	NA	NA	Spare	NA	NA	NA



**Bajaj Energy Ltd, 3X660MW LPGCL, Lalitpur, Uttar Pradesh**

**Station- 765/220kV LPGCL Switchyard**

**Audit Year**

**Document Rev**

Document No- LPGCL-EMD/DP/36

2024

00

**TITLE: Internal Protection Audit of 765kV & 220kV Switchyard**

### A.24 Current transformer (CT-765kV)

Location of CT : Bay 713 CTR

Ratio Test Date : 05.02.2016

Balance Testing (Tan-delta , IR & Winding Resistance ) date : 14.12.2021

Sr No	R-PH(SI. No-37994007243)	Core I	Core II	Core III	Core IV	Core V	Core VI
i	Ratio Adopted	2000/1A	2000/1A	2000/1A	Spare	3000/1A	3000/1A
ii	Ratio measured	1999.60	1999.60	1999.60	Spare	1999.60	1999.60
iii	error calculated	-0.58	-0.18	-0.28	Spare	-0.24	-0.16
iv	Knee point voltage	KVP 2000V at 30mA	KVP 2000V at 30mA	NA	NA	KVP 3000V at 20mA	KVP 3000V at 20mA
Sr No	Y-PH(SI. No-37994007244)	Core I	Core II	Core III	Core IV	Core I	Core II
i	Ratio Adopted	2000/1A	2000/1A	2000/1A	Spare	3000/1A	3000/1A
ii	Ratio measured	1999.60	1999.60	1999.60	Spare	1999.60	1999.60
iii	error calculated	-0.16	-0.14	-0.22	Spare	-0.14	-0.13
iv	Knee point voltage	KVP 2000V at 30mA	KVP 2000V at 30mA	NA	NA	KVP 3000V at 20mA	KVP 3000V at 20mA
Sr No	B-PH(SI. No-37994007239)	Core I	Core II	Core III	Core IV	Core I	Core II
i	Ratio Adopted	2000/1A	2000/1A	2000/1A	Spare	3000/1A	3000/1A
ii	Ratio measured	1999.60	1999.60	1999.60	Spare	1999.60	1999.60
iii	error calculated	-0.16	-0.2	-0.3	Spare	-0.15	-0.13
iv	Knee point voltage	KVP 2000V at 30mA	KVP 2000V at 30mA	NA	NA	KVP 3000V at 20mA	KVP 3000V at 20mA



**Bajaj Energy Ltd, 3X660MW LPGCL, Lalitpur, Uttar Pradesh**

**Station- 765/220kV LPGCL Switchyard**

**Audit Year**

**Document Rev**

Document No- LPGCL-EMD/DP/36

2024

00

**TITLE: Internal Protection Audit of 765kV & 220kV Switchyard**

### A.25 Current transformer (CT-765kV)

Location of CT : Bay 714 CTD

Ratio Test Date : 04.02.2016

Balance Testing (Tan-delta , IR & Winding Resistance ) date : 14.12.2021

Sr No	R-PH(SI. No-37994002371)	Core I	Core II	Core III	Core IV	Core V	Core VI
i	Ratio Adopted	2000/1A	2000/1A	2000/1A	Spare	3000/1A	3000/1A
ii	Ratio measured	1799.60	1799.60	1799.60	Spare	1999.60	1999.60
iii	error calculated	-0.26	-0.21	-0.17	Spare	-0.16	-0.14
iv	Knee point voltage	KVP 2000V at 30mA	KVP 2000V at 30mA	NA	NA	KVP 3000V at 20mA	KVP 3000V at 20mA
Sr No	Y-PH(SI. No-37994002373)	Core I	Core II	Core III	Core IV	Core I	Core II
i	Ratio Adopted	2000/1A	2000/1A	2000/1A	Spare	3000/1A	3000/1A
ii	Ratio measured	1799.60	1799.60	1799.60	Spare	1999.60	1999.60
iii	error calculated	-0.23	-0.17	-0.15	Spare	-0.16	-0.17
iv	Knee point voltage	KVP 2000V at 30mA	KVP 2000V at 30mA	NA	NA	KVP 3000V at 20mA	KVP 3000V at 20mA
Sr No	B-PH(SI. No-37994008752)	Core I	Core II	Core III	Core IV	Core I	Core II
i	Ratio Adopted	2000/1A	2000/1A	2000/1A	Spare	3000/1A	3000/1A
ii	Ratio measured	1799.60	1799.60	1799.60	Spare	1999.60	1999.60
iii	error calculated	-0.18	-0.17	-0.12	Spare	-0.15	-0.16
iv	Knee point voltage	KVP 2000V at 30mA	KVP 2000V at 30mA	NA	NA	KVP 3000V at 20mA	KVP 3000V at 20mA



**Bajaj Energy Ltd, 3X660MW LPGCL, Lalitpur, Uttar Pradesh**

**Station- 765/220kV LPGCL Switchyard**

**Audit Year**

**Document Rev**

Document No- LPGCL-EMD/DP/36

2024

00

**TITLE: Internal Protection Audit of 765kV & 220kV Switchyard**

## A.26 Current transformer (CT-220kV)

Location of CT : Bay 201 CT1T (PCT)

Ratio Test Date : 24.01.2014

Balance Testing (Tan-delta , IR & Winding Resistance ) date : 07.01.2023

Sr No	R-PH (Sl. No-1302F5045)	Core I	Core II	Core III	Core IV	Core V	Core VI
i	Ratio Adopted	800/1A	800/1A	800/1A	SPARE	1200/1A	1200/1A
ii	Ratio measured	640	640	640	SPARE	960	960
iii	error calculated	1.27	0.88	0.13	SPARE	1.39	1.01
iv	Knee point voltage	KVP 800V at 45mA	KVP: 800V at 45mA	NA	NA	KVP: 1200V at 30mA	KVP: 1200V at 30mA
Sr No	Y-PH (Sl. No-1302F5040)	Core I	Core II	Core III	Core IV	Core V	Core VI
i	Ratio Adopted	800/1A	800/1A	800/1A	SPARE	1200/1A	1200/1A
ii	Ratio measured	640	640	640	SPARE	960	960
iii	error calculated	0.63	0.63	-0.25	SPARE		
iv	Knee point voltage	KVP 800V at 45mA	KVP: 800V at 45mA	NA	NA	KVP: 1200V at 30mA	KVP: 1200V at 30mA
Sr No	B-PH (Sl. No-1302F5038)	Core I	Core II	Core III	Core IV	Core V	Core VI
i	Ratio Adopted	800/1A	800/1A	800/1A	SPARE	1200/1A	1200/1A
ii	Ratio measured	640	640	640	SPARE	960	960
iii	error calculated	0.25	0.5	0.13	SPARE	0.5	0.63
iv	Knee point voltage	KVP 800V at 45mA	KVP: 800V at 45mA	NA	NA	KVP: 1200V at 30mA	KVP: 1200V at 30mA



**Bajaj Energy Ltd, 3X660MW LPGCL, Lalitpur, Uttar Pradesh**

**Station- 765/220kV LPGCL Switchyard**

**Audit Year**

**Document Rev**

Document No- LPGCL-EMD/DP/36

2024

00

**TITLE: Internal Protection Audit of 765kV & 220kV Switchyard**

## A.27 Current transformer (CT-220kV)

Location of CT : Bay 201 CT2T (MCT)

Ratio Test Date : 24.01.2014

Balance Testing (Tan-delta , IR & Winding Resistance ) date : 07.01.2023

Sr No	R-PH ( SI. No-1302F50867)	Core I	Core II	Core III	Core IV	Core V
i	Ratio Adopted	800/1A	800/1A	800/1A	NA	NA
ii	Ratio measured	640	640	640	NA	NA
iii	error calculated	0	0.13	0.25	NA	NA
iv	Knee point voltage	NA	NA	NA	NA	NA
Sr No	Y-PH ( SI. No-1302F5076)	Core I	Core II	Core III	Core IV	Core V
i	Ratio Adopted	800/1A	800/1A	800/1A	NA	NA
ii	Ratio measured	640	640	640	NA	NA
iii	error calculated	0	0.13	0.25	NA	NA
iv	Knee point voltage	NA	NA	NA	NA	NA
Sr No	B-PH ( SI. No-1302F5075)	Core I	Core II	Core III	Core IV	Core V
i	Ratio Adopted	800/1A	800/1A	800/1A	NA	NA
ii	Ratio measured	640	640	640	NA	NA
iii	error calculated	0.25	0.13	0	NA	NA
iv	Knee point voltage	NA	NA	NA	NA	NA



**Bajaj Energy Ltd, 3X660MW LPGCL, Lalitpur, Uttar Pradesh**

**Station- 765/220kV LPGCL Switchyard**

**Audit Year**

**Document Rev**

Document No- LPGCL-EMD/DP/36

2024

00

**TITLE: Internal Protection Audit of 765kV & 220kV Switchyard**

### A.28 Current transformer (CT-220kV)

Location of CT : Bay 202 CT1T (PCT)

Ratio Test Date : 24.01.2014

Balance Testing (Tan-delta , IR & Winding Resistance ) date : 18.04.2024

Sr No	R-PH ( Sl. No-1302F5052)	Core I	Core II	Core III	Core IV	Core V	Core VI
i	Ratio Adopted	800/1A	800/1A	800/1A	SPARE	1200/1A	1200/1A
ii	Ratio measured	640	640	640	SPARE	960	960
iii	error calculated	0.63	0.63	0.5	SPARE	0.25	0.5
iv	Knee point voltage	KVP 800V at 45mA	KVP: 800V at 45mA	NA	NA	KVP: 1200V at 30mA	KVP: 1200V at 30mA
Sr No	Y-PH ( Sl. No-1302F5058)	Core I	Core II	Core III	Core IV	Core V	Core VI
i	Ratio Adopted	800/1A	800/1A	800/1A	SPARE	1200/1A	1200/1A
ii	Ratio measured	640	640	640	SPARE	960	960
iii	error calculated	0	-0.12	-0.12	SPARE	0.71	-1.39
iv	Knee point voltage	KVP 800V at 45mA	KVP: 800V at 45mA	NA	NA	KVP: 1200V at 30mA	KVP: 1200V at 30mA
Sr No	B-PH ( Sl. No-1302F5057)	Core I	Core II	Core III	Core IV	Core V	Core VI
i	Ratio Adopted	800/1A	800/1A	800/1A	SPARE	1200/1A	1200/1A
ii	Ratio measured	640	640	640	SPARE	960	960
iii	error calculated	-0.25	0	0	SPARE	-0.23	-0.36
iv	Knee point voltage	KVP 800V at 45mA	KVP: 800V at 45mA	NA	NA	KVP: 1200V at 30mA	KVP: 1200V at 30mA





**Bajaj Energy Ltd, 3X660MW LPGCL, Lalitpur, Uttar Pradesh**

**Station- 765/220kV LPGCL Switchyard**

**Audit Year**

**Document Rev**

Document No- LPGCL-EMD/DP/36

2024

00

**TITLE: Internal Protection Audit of 765kV & 220kV Switchyard**

### A.29 Current transformer (CT-220kV)

Location of CT : Bay 202 CT2T (MCT)

Ratio Test Date : 20.01.2014

Balance Testing (Tan-delta , IR & Winding Resistance ) date : 18.04.2024

Sr No	R-PH ( SI. No-1302F5081)	Core I	Core II	Core III	Core IV	Core V
i	Ratio Adopted	800/1A	800/1A	800/1A	NA	NA
ii	Ratio measured	640	640	640	NA	NA
iii	error calculated	-0.25	-0.12	-0.25	NA	NA
iv	Knee point voltage	NA	NA	NA	NA	NA
Sr No	Y-PH ( SI. No-1302F5083)	Core I	Core II	Core III	Core IV	Core V
i	Ratio Adopted	800/1A	800/1A	800/1A	NA	NA
ii	Ratio measured	640	640	640	NA	NA
iii	error calculated	-0.25	-0.74	0	NA	NA
iv	Knee point voltage	NA	NA	NA	NA	NA
Sr No	B-PH ( SI. No-1302F5084)	Core I	Core II	Core III	Core IV	Core V
i	Ratio Adopted	800/1A	800/1A	800/1A	NA	NA
ii	Ratio measured	640	640	640	NA	NA
iii	error calculated	0.13	-0.25	-0.12	NA	NA
iv	Knee point voltage	NA	NA	NA	NA	NA



**Bajaj Energy Ltd, 3X660MW LPGCL, Lalitpur, Uttar Pradesh**

**Station- 765/220kV LPGCL Switchyard**

**Audit Year**

**Document Rev**

Document No- LPGCL-EMD/DP/36

2024

00

**TITLE: Internal Protection Audit of 765kV & 220kV Switchyard**

### A.30 Current transformer (CT-220kV)

Location of CT : Bay 203 CT1T (PCT)

Ratio Test Date : 24.01.2014

Balance Testing (Tan-delta , IR & Winding Resistance ) date : 16.04.2024

Sr No	R-PH (Sl. No-1302F5046)	Core I	Core II	Core III	Core IV	Core V	Core VI
i	Ratio Adopted	800/1A	800/1A	800/1A	SPARE	1200/1A	1200/1A
ii	Ratio measured	640	640	640	SPARE	960	960
iii	error calculated	-0.12	0	-0.25	SPARE	0	0
iv	Knee point voltage	KVP 800V at 45mA	KVP: 800V at 45mA	NA	NA	KVP: 1200V at 30mA	KVP: 1200V at 30mA
Sr No	Y-PH (Sl. No-1302F5048)	Core I	Core II	Core III	Core IV	Core V	Core VI
i	Ratio Adopted	800/1A	800/1A	800/1A	SPARE	1200/1A	1200/1A
ii	Ratio measured	640	640	640	SPARE	960	960
iii	error calculated	1.01	0.5	0	SPARE	0.25	0.25
iv	Knee point voltage	KVP 800V at 45mA	KVP: 800V at 45mA	NA	NA	KVP: 1200V at 30mA	KVP: 1200V at 30mA
Sr No	B-PH (Sl. No-1302F5049)	Core I	Core II	Core III	Core IV	Core V	Core VI
i	Ratio Adopted	800/1A	800/1A	800/1A	SPARE	1200/1A	1200/1A
ii	Ratio measured	640	640	640	SPARE	960	960
iii	error calculated	-0.25	0.63	0.25	SPARE	0.5	-0.12
iv	Knee point voltage	KVP 800V at 45mA	KVP: 800V at 45mA	NA	NA	KVP: 1200V at 30mA	KVP: 1200V at 30mA



**Bajaj Energy Ltd, 3X660MW LPGCL, Lalitpur, Uttar Pradesh**

**Station- 765/220kV LPGCL Switchyard**

**Audit Year**

**Document Rev**

Document No- LPGCL-EMD/DP/36

2024

00

**TITLE: Internal Protection Audit of 765kV & 220kV Switchyard**

### A.31 Current transformer (CT-220kV)

Location of CT : Bay 203 CT2T (MCT)

Ratio Test Date : 23.01.2014

Balance Testing (Tan-delta , IR & Winding Resistance ) date : 16.04.2024

Sr No	R-PH (Sl. No-1302F5069)	Core I	Core II	Core III	Core IV	Core V
i	Ratio Adopted	800/1A	800/1A	800/1A	NA	NA
ii	Ratio measured	640	640	640	NA	NA
iii	error calculated	0	0.13	0.25	NA	NA
iv	Knee point voltage	NA	NA	NA	NA	NA
Sr No	Y-PH (Sl. No-1302F5068)	Core I	Core II	Core III	Core IV	Core V
i	Ratio Adopted	800/1A	800/1A	800/1A	NA	NA
ii	Ratio measured	640	640	640	NA	NA
iii	error calculated	0	-0.12	0	NA	NA
iv	Knee point voltage	NA	NA	NA	NA	NA
Sr No	B-PH (Sl. No-1302F5082)	Core I	Core II	Core III	Core IV	Core V
i	Ratio Adopted	800/1A	800/1A	800/1A	NA	NA
ii	Ratio measured	640	640	640	NA	NA
iii	error calculated	0.13	0.25	0	NA	NA
iv	Knee point voltage	NA	NA	NA	NA	NA



**Bajaj Energy Ltd, 3X660MW LPGCL, Lalitpur, Uttar Pradesh**

**Station- 765/220kV LPGCL Switchyard**

**Audit Year**

**Document Rev**

Document No- LPGCL-EMD/DP/36

2024

00

**TITLE: Internal Protection Audit of 765kV & 220kV Switchyard**

**A.32 Current transformer (CT-220kV)**

Location of CT : Bay 204 CT1T (PCT)

Ratio Test Date : 23.01.2014

Balance Testing (Tan-delta , IR & Winding Resistance ) date : 22.11.2023

Sr No	R-PH (Sl. No-1302F5053)	Core I	Core II	Core III	Core IV	Core V	Core VI
i	Ratio Adopted	800/1A	800/1A	800/1A	SPARE	1200/1A	1200/1A
ii	Ratio measured	640	640	640	SPARE	960	960
iii	error calculated	0.25	0.63	0.25	SPARE	0.5	-0.12
iv	Knee point voltage	KVP 800V at 45mA	KVP: 800V at 45mA	NA	NA	KVP: 1200V at 30mA	KVP: 1200V at 30mA
Sr No	Y-PH (Sl. No-1302F5039)	Core I	Core II	Core III	Core IV	Core V	Core VI
i	Ratio Adopted	800/1A	800/1A	800/1A	SPARE	1200/1A	1200/1A
ii	Ratio measured	640	640	640	SPARE	960	960
iii	error calculated	0	-0.12	0.13	SPARE	0.63	0.63
iv	Knee point voltage	KVP 800V at 45mA	KVP: 800V at 45mA	NA	NA	KVP: 1200V at 30mA	KVP: 1200V at 30mA
Sr No	B-PH (Sl. No-1302F5044)	Core I	Core II	Core III	Core IV	Core V	Core VI
i	Ratio Adopted	800/1A	800/1A	800/1A	SPARE	1200/1A	1200/1A
ii	Ratio measured	640	640	640	SPARE	960	960
iii	error calculated	-0.12	0	-0.25	SPARE	0	0
iv	Knee point voltage	KVP 800V at 45mA	KVP: 800V at 45mA	NA	NA	KVP: 1200V at 30mA	KVP: 1200V at 30mA



**Bajaj Energy Ltd, 3X660MW LPGCL, Lalitpur, Uttar Pradesh**

**Station- 765/220kV LPGCL Switchyard**

**Audit Year**

**Document Rev**

Document No- LPGCL-EMD/DP/36

2024

00

**TITLE: Internal Protection Audit of 765kV & 220kV Switchyard**

### A.33 Current transformer (CT-220kV)

Location of CT : Bay 204 CT2T (MCT)

Ratio Test Date : 22.01.2014

Balance Testing (Tan-delta , IR & Winding Resistance ) date : 22.11.2023

Sr No	R-PH (Sl. No-1302F5070)	Core I	Core II	Core III	Core IV	Core V
i	Ratio Adopted	800/1A	800/1A	800/1A	NA	NA
ii	Ratio measured	640	640	640	NA	NA
iii	error calculated	0.13	0	-0.25	NA	NA
iv	Knee point voltage	NA	NA	NA	NA	NA
Sr No	Y-PH ( Sl. No-1302F5079)	Core I	Core II	Core III	Core IV	Core V
i	Ratio Adopted	800/1A	800/1A	800/1A	NA	NA
ii	Ratio measured	640	640	640	NA	NA
iii	error calculated	0.13	-0.25	0.63	NA	NA
iv	Knee point voltage	NA	NA	NA	NA	NA
Sr No	B-PH (Sl. No-1302F5078)	Core I	Core II	Core III	Core IV	Core V
i	Ratio Adopted	800/1A	800/1A	800/1A	NA	NA
ii	Ratio measured	640	640	640	NA	NA
iii	error calculated	0	-0.25	0.25	NA	NA
iv	Knee point voltage	NA	NA	NA	NA	NA



**Bajaj Energy Ltd, 3X660MW LPGCL, Lalitpur, Uttar Pradesh**

**Station- 765/220kV LPGCL Switchyard**

**Audit Year**

**Document Rev**

Document No- LPGCL-EMD/DP/36

2024

00

**TITLE: Internal Protection Audit of 765kV & 220kV Switchyard**

**A.34 Current transformer (CT-220kV)**

Location of CT : Bay 205 CT (PCT)

Ratio Test Date : 19.01.2014

Balance Testing (Tan-delta , IR & Winding Resistance ) date : 28.02.2024

Sr No	R-PH (Sl. No-1302F5042)	Core I	Core II	Core III	Core IV	Core V	Core VI
i	Ratio Adopted	800/1A	SPARE	800/1A	SPARE	1200/1A	1200/1A
ii	Ratio measured	640	SPARE	640	SPARE	960	960
iii	error calculated	0.76	SPARE	0.25	SPARE	0.63	0.38
iv	Knee point voltage	KVP 800V at 45mA	SPARE	NA	NA	KVP: 1200V at 30mA	KVP: 1200V at 30mA
Sr No	Y-PH (Sl. No-1302F5047)	Core I	Core II	Core III	Core IV	Core V	Core VI
i	Ratio Adopted	800/1A	SPARE	800/1A	SPARE	1200/1A	1200/1A
ii	Ratio measured	640	SPARE	640	SPARE	960	960
iii	error calculated	-0.12	SPARE	-0.25	SPARE	0.63	0.25
iv	Knee point voltage	KVP 800V at 45mA	SPARE	NA	NA	KVP: 1200V at 30mA	KVP: 1200V at 30mA
Sr No	B-PH (Sl. No-1302F5043)	Core I	Core II	Core III	Core IV	Core V	Core VI
i	Ratio Adopted	800/1A	SPARE	800/1A	SPARE	1200/1A	1200/1A
ii	Ratio measured	640	SPARE	640	SPARE	960	960
iii	error calculated	-0.25	SPARE	-0.5	SPARE	1.01	1.14
iv	Knee point voltage	KVP 800V at 45mA	SPARE	NA	NA	KVP: 1200V at 30mA	KVP: 1200V at 30mA



**Bajaj Energy Ltd, 3X660MW LPGCL, Lalitpur, Uttar Pradesh**

**Station- 765/220kV LPGCL Switchyard**

**Audit Year**

**Document Rev**

Document No- LPGCL-EMD/DP/36

2024

00

**TITLE: Internal Protection Audit of 765kV & 220kV Switchyard**

### A.35 Current transformer (CT-220kV)

Location of CT : Bay 206 CT1BC (PCT)

Ratio Test Date : 18.01.2014

Balance Testing (Tan-delta , IR & Winding Resistance ) date : 25.11.2023

Sr No	R-PH ( SI. No-1302F5063)	Core I	Core II	Core III	Core IV	Core V
i	Ratio Adopted	1600/1A	2000/1A	1600/1A	2000/1A	2000/1A
ii	Ratio measured	960	1000	960	1000	1000
iii	error calculated	0.5	-0.2	-0.66	-0.2	-0.4
iv	Knee point voltage	KVP: 1600V at 32mA	KVP: 2000V at 20mA	NA	KVP: 2000V at 20mA	KVP: 2000V at 20mA
Sr No	Y-PH ( SI. No-1302F5059)	Core I	Core II	Core III	Core IV	Core V
i	Ratio Adopted	1600/1A	2000/1A	1600/1A	2000/1A	2000/1A
ii	Ratio measured	960	1000	960	1000	1000
iii	error calculated	0	-0.79	-0.5	-0.4	-0.2
iv	Knee point voltage	KVP: 1600V at 32mA	KVP: 2000V at 20mA	NA	KVP: 2000V at 20mA	KVP: 2000V at 20mA
Sr No	B-PH ( SI. No-1302F5060)	Core I	Core II	Core III	Core IV	Core V
i	Ratio Adopted	1600/1A	2000/1A	1600/1A	2000/1A	2000/1A
ii	Ratio measured	960	1000	960	1000	1000
iii	error calculated	0	-0.2	-0.33	0	-0.4
iv	Knee point voltage	KVP: 1600V at 32mA	KVP: 2000V at 20mA	NA	KVP: 2000V at 20mA	KVP: 2000V at 20mA



**Bajaj Energy Ltd, 3X660MW LPGCL, Lalitpur, Uttar Pradesh**

**Station- 765/220kV LPGCL Switchyard**

**Audit Year**

**Document Rev**

Document No- LPGCL-EMD/DP/36

2024

00

**TITLE: Internal Protection Audit of 765kV & 220kV Switchyard**

### A.36 Current transformer (CT-220kV)

Location of CT : Bay 206 CT2BC (PCT)

Ratio Test Date :

Balance Testing (Tan-delta , IR & Winding Resistance ) date : 25.11.2023

Sr No	R-PH ( SI. No-1302F5061)	Core I	Core II	Core III	Core IV	Core V
i	Ratio Adopted	1600/1A	2000/1A	1600/1A	2000/1A	2000/1A
ii	Ratio measured	960	1000	960	1000	1000
iii	error calculated	0.17	-0.99	-0.66	-0.99	0
iv	Knee point voltage	KVP: 1600V at 32mA	KVP: 2000V at 20mA	NA	KVP: 2000V at 20mA	KVP: 2000V at 20mA
Sr No	Y-PH ( SI. No-1302F5064)	Core I	Core II	Core III	Core IV	Core V
i	Ratio Adopted	1600/1A	2000/1A	1600/1A	2000/1A	2000/1A
ii	Ratio measured	960	1000	960	1000	1000
iii	error calculated	-0.66	-0.4	-0.5	0.2	-0.4
iv	Knee point voltage	KVP: 1600V at 32mA	KVP: 2000V at 20mA	NA	KVP: 2000V at 20mA	KVP: 2000V at 20mA
Sr No	B-PH ( SI. No-1302F5062)	Core I	Core II	Core III	Core IV	Core V
i	Ratio Adopted	1600/1A	2000/1A	1600/1A	2000/1A	2000/1A
ii	Ratio measured	1100	1000	1100	1000	1000
iii	error calculated	-0.36	0.4	-0.65	-0.99	-1.19
iv	Knee point voltage	KVP: 1600V at 32mA	KVP: 2000V at 20mA	NA	KVP: 2000V at 20mA	KVP: 2000V at 20mA





**Bajaj Energy Ltd, 3X660MW LPGCL, Lalitpur, Uttar Pradesh**

**Station- 765/220kV LPGCL Switchyard**

**Audit Year**

**Document Rev**

Document No- LPGCL-EMD/DP/36

2024

00

**TITLE: Internal Protection Audit of 765kV & 220kV Switchyard**

**A.37 Current transformer (CT-220kV)**

Location of CT : Bay 207 CT1T (PCT)

Ratio Test Date : 14.01.2014

Balance Testing (Tan-delta , IR & Winding Resistance ) date : 08.10.2018

Sr No	R-PH ( Sl. No-1302F5054)	Core I	Core II	Core III	Core IV	Core V	Core VI
i	Ratio Adopted	800/1A	800/1A	800/1A	SPARE	1200/1A	1200/1A
ii	Ratio measured	640	640	640	SPARE	960	960
iii	error calculated	0.63	0.76	0.63	SPARE	0.76	0.76
iv	Knee point voltage	KVP 800V at 45mA	KVP: 800V at 45mA	NA	NA	KVP: 1200V at 30mA	KVP: 1200V at 30mA
Sr No	Y-PH ( Sl. No-1302F5056)	Core I	Core II	Core III	Core IV	Core V	Core VI
i	Ratio Adopted	800/1A	800/1A	800/1A	SPARE	1200/1A	1200/1A
ii	Ratio measured	640	640	640	SPARE	960	960
iii	error calculated		0.76	0.38	SPARE	0.25	0.13
iv	Knee point voltage	KVP 800V at 45mA	KVP: 800V at 45mA	NA	NA	KVP: 1200V at 30mA	KVP: 1200V at 30mA
Sr No	B-PH ( Sl. No-1302F5051)	Core I	Core II	Core III	Core IV	Core V	Core VI
i	Ratio Adopted	800/1A	800/1A	800/1A	SPARE	1200/1A	1200/1A
ii	Ratio measured	640	640	640	SPARE	960	960
iii	error calculated	-0.12	-0.25	-0.37	SPARE	0.63	0.5
iv	Knee point voltage	KVP 800V at 45mA	KVP: 800V at 45mA	NA	NA	KVP: 1200V at 30mA	KVP: 1200V at 30mA



**Bajaj Energy Ltd, 3X660MW LPGCL, Lalitpur, Uttar Pradesh**

**Station- 765/220kV LPGCL Switchyard**

**Audit Year**

**Document Rev**

Document No- LPGCL-EMD/DP/36

2024

00

**TITLE: Internal Protection Audit of 765kV & 220kV Switchyard**

### A.38 Current transformer (CT-220kV)

Location of CT : Bay 207 CT2T (MCT)

Ratio Test Date : 14.01.2014

Balance Testing (Tan-delta , IR & Winding Resistance ) date : 08.10.2018

Sr No	R-PH ( SI. No-37994000669)	Core I	Core II	Core III	Core IV	Core V
i	Ratio Adopted	800/1A	800/1A	800/1A	NA	NA
ii	Ratio measured	640	640	640	NA	NA
iii	error calculated	-0.62	0	0.13	NA	NA
iv	Knee point voltage	NA	NA	NA	NA	NA
Sr No	Y-PH ( SI. No-1302F5073)	Core I	Core II	Core III	Core IV	Core V
i	Ratio Adopted	800/1A	800/1A	800/1A	NA	NA
ii	Ratio measured	640	640	640	NA	NA
iii	error calculated	0.38	0.25	0.76	NA	NA
iv	Knee point voltage	NA	NA	NA	NA	NA
Sr No	B-PH ( SI. No-1302F5072)	Core I	Core II	Core III	Core IV	Core V
i	Ratio Adopted	800/1A	800/1A	800/1A	NA	NA
ii	Ratio measured	640	640	640	NA	NA
iii	error calculated	0.13	0.13	0	NA	NA
iv	Knee point voltage	NA	NA	NA	NA	NA



**Bajaj Energy Ltd, 3X660MW LPGCL, Lalitpur, Uttar Pradesh**

**Station- 765/220kV LPGCL Switchyard**

**Audit Year**

**Document Rev**

Document No- LPGCL-EMD/DP/36

2024

00

**TITLE: Internal Protection Audit of 765kV & 220kV Switchyard**

### A.39 Current transformer (CT-220kV)

Location of CT : Bay 208 CT1T (PCT)

Ratio Test Date : 09.01.2014

Balance Testing (Tan-delta , IR & Winding Resistance ) date : 12.11.2021

Sr No	R-PH (Sl. No-1302F5041)	Core I	Core II	Core III	Core IV	Core V	Core VI
i	Ratio Adopted	800/1A	800/1A	800/1A	SPARE	1200/1A	1200/1A
ii	Ratio measured	640	640	640	SPARE	960	960
iii	error calculated	0.88	0.76	0.25	SPARE	0	0
iv	Knee point voltage	KVP 800V at 45mA	KVP: 800V at 45mA	NA	NA	KVP: 1200V at 30mA	KVP: 1200V at 30mA
Sr No	Y-PH (Sl. No-1302F5050)	Core I	Core II	Core III	Core IV	Core V	Core VI
i	Ratio Adopted	800/1A	800/1A	800/1A	SPARE	1200/1A	1200/1A
ii	Ratio measured	640	640	640	SPARE	960	960
iii	error calculated	0.21	1.39	1.39	SPARE	1.01	1.14
iv	Knee point voltage	KVP 800V at 45mA	KVP: 800V at 45mA	NA	NA	KVP: 1200V at 30mA	KVP: 1200V at 30mA
Sr No	B-PH (Sl. No-1302F5055)	Core I	Core II	Core III	Core IV	Core V	Core VI
i	Ratio Adopted	800/1A	800/1A	800/1A	SPARE	1200/1A	1200/1A
ii	Ratio measured	640	640	640	SPARE	960	960
iii	error calculated	0.63	0.13	-0.62	SPARE	1.39	1.39
iv	Knee point voltage	KVP 800V at 45mA	KVP: 800V at 45mA	NA	NA	KVP: 1200V at 30mA	KVP: 1200V at 30mA



**Bajaj Energy Ltd, 3X660MW LPGCL, Lalitpur, Uttar Pradesh**

**Station- 765/220kV LPGCL Switchyard**

**Audit Year**

**Document Rev**

Document No- LPGCL-EMD/DP/36

2024

00

**TITLE: Internal Protection Audit of 765kV & 220kV Switchyard**

#### A.40 Current transformer (CT-220kV)

Location of CT : Bay 208 CT2T (MCT)

Ratio Test Date : 15.01.2014

Balance Testing (Tan-delta , IR & Winding Resistance ) date : 12.11.2021

Sr No	R-PH ( SI. No-1302F5085)	Core I	Core II	Core III	Core IV	Core V
i	Ratio Adopted	800/1A	800/1A	800/1A	NA	NA
ii	Ratio measured	640	640	640	NA	NA
iii	error calculated	0.63	0.63	0.63	NA	NA
iv	Knee point voltage	NA	NA	NA	NA	NA
Sr No	Y-PH ( SI. No-1302F5066)	Core I	Core II	Core III	Core IV	Core V
i	Ratio Adopted	800/1A	800/1A	800/1A	NA	NA
ii	Ratio measured	640	640	640	NA	NA
iii	error calculated	0.76	0.25	0.63	NA	NA
iv	Knee point voltage	NA	NA	NA	NA	NA
Sr No	B-PH ( SI. No-1302F5074)	Core I	Core II	Core III	Core IV	Core V
i	Ratio Adopted	800/1A	800/1A	800/1A	NA	NA
ii	Ratio measured	640	640	640	NA	NA
iii	error calculated	1.27	1.39	1.39	NA	NA
iv	Knee point voltage	NA	NA	NA	NA	NA



**Bajaj Energy Ltd, 3X660MW LPGCL, Lalitpur, Uttar Pradesh**

**Station- 765/220kV LPGCL Switchyard**

**Audit Year**

**Document Rev**

Document No- LPGCL-EMD/DP/36

2024

00

**TITLE: Internal Protection Audit of 765kV & 220kV Switchyard**

**A.41 Current transformer (CT-220kV)**

Location of CT : Bay 209 CT1T (PCT)

Ratio Test Date : 09.01.2014

Balance Testing (Tan-delta , IR & Winding Resistance ) date : 05.03.2018

Sr No	R-PH (Sl. No-37994000958)	Core I	Core II	Core III	Core IV	Core V	Core VI
i	Ratio Adopted	800/1A	300/1A	300/1A	SPARE	1200/1A	1200/1A
ii	Ratio measured	640	240	240	SPARE	960	960
iii	error calculated	-0.12	-0.5	0	SPARE	2.3	1.39
iv	Knee point voltage	KVP 800V at 45mA	KVP: 300V at 120mA	NA	NA	KVP: 1200V at 30mA	KVP: 1200V at 30mA
Sr No	Y-PH (Sl. No-37994000954)	Core I	Core II	Core III	Core IV	Core V	Core VI
i	Ratio Adopted	800/1A	300/1A	300/1A	SPARE	1200/1A	1200/1A
ii	Ratio measured	640	240	240	SPARE	960	960
iii	error calculated	0	0	-0.74	SPARE	0	0.61
iv	Knee point voltage	KVP 800V at 45mA	KVP: 300V at 120mA	NA	NA	KVP: 1200V at 30mA	KVP: 1200V at 30mA
Sr No	B-PH (Sl. No-37994000953)	Core I	Core II	Core III	Core IV	Core V	Core VI
i	Ratio Adopted	800/1A	300/1A	300/1A	SPARE	1200/1A	1200/1A
ii	Ratio measured	640	240	240	SPARE	960	960
iii	error calculated	0.63	1.39	1.01	SPARE	-1.48	-1.48
iv	Knee point voltage	KVP 800V at 45mA	KVP: 300V at 120mA	NA	NA	KVP: 1200V at 30mA	KVP: 1200V at 30mA



**Bajaj Energy Ltd, 3X660MW LPGCL, Lalitpur, Uttar Pradesh**

**Station- 765/220kV LPGCL Switchyard**

**Audit Year**

**Document Rev**

Document No- LPGCL-EMD/DP/36

2024

00

**TITLE: Internal Protection Audit of 765kV & 220kV Switchyard**

#### A.42 Current transformer (CT-220kV)

Location of CT : Bay 209 CT2T (MCT)

Ratio Test Date : 09.01.2014

Balance Testing (Tan-delta , IR & Winding Resistance ) date : 05.03.2018

Sr No	R-PH (Sl. No-37994000678)	Core I	Core II	Core III	Core IV	Core V
i	Ratio Adopted	300/1A	300/1A	SPARE	NA	NA
ii	Ratio measured	240	240	SPARE	NA	NA
iii	error calculated	1.01	0.5	SPARE	NA	NA
iv	Knee point voltage	NA	NA	NA	NA	NA
Sr No	Y-PH (Sl. No-37994000680)	Core I	Core II	Core III	Core IV	Core V
i	Ratio Adopted	300/1A	300/1A	SPARE	NA	NA
ii	Ratio measured	240	240	SPARE	NA	NA
iii	error calculated	-0.25	0.88	SPARE	NA	NA
iv	Knee point voltage	NA	NA	NA	NA	NA
Sr No	B-PH (Sl. No-37994000677)	Core I	Core II	Core III	Core IV	Core V
i	Ratio Adopted	300/1A	300/1A	SPARE	NA	NA
ii	Ratio measured	240	240	SPARE	NA	NA
iii	error calculated	-0.62	-0.25	SPARE	NA	NA
iv	Knee point voltage	NA	NA	NA	NA	NA



**Bajaj Energy Ltd, 3X660MW LPGCL, Lalitpur, Uttar Pradesh**

**Station- 765/220kV LPGCL Switchyard**

**Audit Year**

**Document Rev**

Document No- LPGCL-EMD/DP/36

2024

00

**TITLE: Internal Protection Audit of 765kV & 220kV Switchyard**

**A.43 Current transformer (CT-220kV)**

Location of CT : Bay 210 CT1T (PCT)

Ratio Test Date : 09.01.2014

Balance Testing (Tan-delta , IR & Winding Resistance ) date : 26.02.2018

Sr No	R-PH (Sl. No-37994000956)	Core I	Core II	Core III	Core IV	Core V	Core VI
i	Ratio Adopted	800/1A	300/1A	300/1A	SPARE	1200/1A	1200/1A
ii	Ratio measured	640	240	240	SPARE	960	960
iii	error calculated	0.13	0.13	-0.62	SPARE	-0.12	0.31
iv	Knee point voltage	KVP 800V at 45mA	KVP: 300V at 120mA	NA	NA	KVP: 1200V at 30mA	KVP: 1200V at 30mA
Sr No	Y-PH (Sl. No-37994000955)	Core I	Core II	Core III	Core IV	Core V	Core VI
i	Ratio Adopted	800/1A	300/1A	300/1A	SPARE	1200/1A	1200/1A
ii	Ratio measured	640	240	240	SPARE	960	960
iii	error calculated	0.25	-0.62	-0.12	SPARE	1.44	1.44
iv	Knee point voltage	KVP 800V at 45mA	KVP: 300V at 120mA	NA	NA	KVP: 1200V at 30mA	KVP: 1200V at 30mA
Sr No	B-PH (Sl. No-37994000957)	Core I	Core II	Core III	Core IV	Core V	Core VI
i	Ratio Adopted	800/1A	300/1A	300/1A	SPARE	1200/1A	1200/1A
ii	Ratio measured	640	240	240	SPARE	960	960
iii	error calculated	0.63	-1.11	-1.11	SPARE	1.29	1.29
iv	Knee point voltage	KVP 800V at 45mA	KVP: 300V at 120mA	NA	NA	KVP: 1200V at 30mA	KVP: 1200V at 30mA



**Bajaj Energy Ltd, 3X660MW LPGCL, Lalitpur, Uttar Pradesh**

**Station- 765/220kV LPGCL Switchyard**

**Audit Year**

**Document Rev**

Document No- LPGCL-EMD/DP/36

2024

00

**TITLE: Internal Protection Audit of 765kV & 220kV Switchyard**

#### A.44 Current transformer (CT-220kV)

Location of CT : Bay 210 CT2T (MCT)

Ratio Test Date : 09.01.2014

Balance Testing (Tan-delta , IR & Winding Resistance ) date : 26.02.2018

Sr No	R-PH (Sl. No-37994000681)	Core I	Core II	Core III	Core IV	Core V
i	Ratio Adopted	300/1A	300/1A	SPARE	NA	NA
ii	Ratio measured	240	240	SPARE	NA	NA
iii	error calculated	1.01	0.5	SPARE	NA	NA
iv	Knee point voltage	NA	NA	NA	NA	NA
Sr No	Y-PH (Sl. No-37994000679)	Core I	Core II	Core III	Core IV	Core V
i	Ratio Adopted	300/1A	300/1A	SPARE	NA	NA
ii	Ratio measured	240	240	SPARE	NA	NA
iii	error calculated	-0.25	0.88	SPARE	NA	NA
iv	Knee point voltage	NA	NA	NA	NA	NA
Sr No	B-PH (Sl. No-37994000675)	Core I	Core II	Core III	Core IV	Core V
i	Ratio Adopted	300/1A	300/1A	SPARE	NA	NA
ii	Ratio measured	240	240	SPARE	NA	NA
iii	error calculated	-0.62	-0.25	SPARE	NA	NA
iv	Knee point voltage	NA	NA	NA	NA	NA





**Bajaj Energy Ltd, 3X660MW LPGCL, Lalitpur, Uttar Pradesh**

**Station- 765/220kV LPGCL Switchyard**

**Audit Year**

**Document Rev**

Document No- LPGCL-EMD/DP/36

2024

00

**TITLE: Internal Protection Audit of 765kV & 220kV Switchyard**

#### A.45 Current transformer (CT-220kV)

Location of CT : ST #01 (HVBCT)

Ratio Test Date : 28.02.2014

Sr No	R-PH	Core I	Core II	Core III	Core IV
I	Ratio Adopted	600/1A	600/1A	600/1A	NA
li	Ratio measured	480	480	480	NA
lii	error calculated	-0.1	-0.5	-0.1	NA
lv	Knee point voltage	KVP : 600 at 100ma	KVP : 600 at 100ma	KVP : 600 at 100ma	NA
Sr No	Y-PH	Core I	Core II	Core III	Core IV
I	Ratio Adopted	600/1A	600/1A	600/1A	
li	Ratio measured	480	480	480	236
lii	error calculated	0.4	-0.2	-0.1	-0.3
lv	Knee point voltage	KVP : 600 at 100ma	KVP : 600 at 100ma	KVP : 600 at 100ma	NA
Sr No	B-PH	Core I	Core II	Core III	Core IV
I	Ratio Adopted	600/1A	600/1A	600/1A	NA
li	Ratio measured	480	480	480	NA
lii	error calculated	-0.4	-0.4	-0.4	NA
iv	Knee point voltage	KVP : 600 at 100ma	KVP : 600 at 100ma	KVP : 600 at 100ma	NA



**Bajaj Energy Ltd, 3X660MW LPGCL, Lalitpur, Uttar Pradesh**

**Station- 765/220kV LPGCL Switchyard**

**Audit Year**

**Document Rev**

Document No- LPGCL-EMD/DP/36

2024

00

**TITLE: Internal Protection Audit of 765kV & 220kV Switchyard**

#### A.46 Current transformer (CT-220kV)

Location of CT : ST #02 (HVBCT)

Ratio Test Date : 28.05.2015

Sr No	R-PH	Core I	Core II	Core III	Core IV
i	Ratio Adopted	600/1A	600/1A	600/1A	NA
ii	Ratio measured	480	480	480	NA
iii	error calculated	-0.25	-0.375	-0.25	NA
iv	Knee point voltage	KVP : 600 at 100ma	KVP : 600 at 100ma	KVP : 600 at 100ma	NA
Sr No	Y-PH	Core I	Core II	Core III	Core IV
i	Ratio Adopted	600/1A	600/1A	600/1A	
ii	Ratio measured	480	480	480	236
iii	error calculated	-0.25	-1	-0.125	1.597
iv	Knee point voltage	KVP : 600 at 100ma	KVP : 600 at 100ma	KVP : 600 at 100ma	NA
Sr No	B-PH	Core I	Core II	Core III	Core IV
i	Ratio Adopted	600/1A	600/1A	600/1A	NA
ii	Ratio measured	480	480	480	NA
iii	error calculated	-0.125	-0.75	-0.125	NA
iv	Knee point voltage	KVP : 600 at 100ma	KVP : 600 at 100ma	KVP : 600 at 100ma	NA



**Bajaj Energy Ltd, 3X660MW LPGCL, Lalitpur, Uttar Pradesh**

**Station- 765/220kV LPGCL Switchyard**

**Audit Year**

**Document Rev**

Document No- LPGCL-EMD/DP/36

2024

00

**TITLE: Internal Protection Audit of 765kV & 220kV Switchyard**

**A.47 Current transformer (CT-765kV)**

Location of CT : ICT #01 (BCT)

Ratio Test Date : May-2015

Sr No	R-PH	1.1 Core I	1.1 Core II	1.1 Core III	1.2 Core I	1.2 Core II	2.1 Core I	2.1 Core II	2.1 Core III	3.1 Core 1
i	Ratio Adopted	2000/1A	2000/1A	1000/1A	1000/1A	1000/1A	1000/1A	1000/1A	1000/1A	200/1
ii	Ratio measured	250	250	250	1000	1000	800	800	800	160
iii	error calculated	0.81	-0.79	0	-0.99	-1.15	-0.62	-1.98	-0.25	-1.69
iv	Knee point voltage	KVP : 2000 at 30mA	KVP : 2000 at 30mA	KVP : 1000 at 60mA	KVP : 1000 at 60mA	KVP : 1000 at 60mA	KVP : 1000 at 60mA	KVP : 1000 at 60mA	KVP : 1000 at 60mA	KVP : 200 at 250mA
Sr No	Y-PH	1.1 Core I	1.1 Core II	1.1 Core III	1.2 Core I	1.2 Core II	2.1 Core I	2.1 Core II	2.1 Core III	3.1 Core 1
i	Ratio Adopted	600/1A	600/1A	600/1A	1000/1A	1000/1A	1000/1A	1000/1A	1000/1A	200/1
ii	Ratio measured	250	250	250	1000	1000	800	800	800	160
iii	error calculated	1.59	1.59	1.59	0.1	0.3	-0.12	-0.12	0	-0.25
iv	Knee point voltage	KVP : 2000 at 30mA	KVP : 2000 at 30mA	KVP : 1000 at 60mA	KVP : 1000 at 60mA	KVP : 1000 at 60mA	KVP : 1000 at 60mA	KVP : 1000 at 60mA	KVP : 1000 at 60mA	KVP : 200 at 250mA
Sr No	B-PH	1.1 Core I	1.1 Core II	1.1 Core III	1.2 Core I	1.2 Core II	2.1 Core I	2.1 Core II	2.1 Core III	3.1 Core 1
i	Ratio Adopted	600/1A	600/1A	600/1A	1000/1A	1000/1A	1000/1A	1000/1A	1000/1A	200/1
ii	Ratio measured	250	250	250	600	600	800	800	800	160
iii	error calculated	-0.8	-0.8	-1.2	0.099	0.299	0.49	0.624	0.49	-1.53
iv	Knee point voltage	KVP : 2000 at 30mA	KVP : 2000 at 30mA	KVP : 1000 at 60mA	KVP : 1000 at 60mA	KVP : 1000 at 60mA	KVP : 1000 at 60mA	KVP : 1000 at 60mA	KVP : 1000 at 60mA	KVP : 200 at 250mA



**Bajaj Energy Ltd, 3X660MW LPGCL, Lalitpur, Uttar Pradesh**

**Station- 765/220kV LPGCL Switchyard**

**Audit Year**

**Document Rev**

Document No- LPGCL-EMD/DP/36

2024

00

**TITLE: Internal Protection Audit of 765kV & 220kV Switchyard**

**A.48 Current transformer (CT-765kV)**

Location of CT : ICT #02 (BCT)

Ratio Test Date : July-2015

Sr No	R-PH	1.1 Core I	1.1 Core II	1.1 Core III	1.2 Core I	1.2 Core II	2.1 Core I	2.1 Core II	2.1 Core III	3.1 Core 1
i	Ratio Adopted	2000/1A	2000/1A	1000/1A	1000/1A	1000/1A	1000/1A	1000/1A	1000/1A	200/1
ii	Ratio measured	250	250	250	1000	1000	800	800	800	160
iii	error calculated	0.397	0	0.398	-0.1	0	0.249	0.249	0.125	-0.1
iv	Knee point voltage	KVP : 2000 at 30mA	KVP : 2000 at 30mA	KVP : 1000 at 60mA	KVP : 1000 at 60mA	KVP : 1000 at 60mA	KVP : 1000 at 60mA	KVP : 1000 at 60mA	KVP : 1000 at 60mA	KVP : 200 at 250mA
Sr No	Y-PH	1.1 Core I	1.1 Core II	1.1 Core III	1.2 Core I	1.2 Core II	2.1 Core I	2.1 Core II	2.1 Core III	3.1 Core 1
i	Ratio Adopted	600/1A	600/1A	600/1A	1000/1A	1000/1A	1000/1A	1000/1A	1000/1A	200/1
ii	Ratio measured	250	250	250	1000	1000	800	800	800	160
iii	error calculated	-0.4	-0.4	0	0	0.1	0.249	0.124	-0.125	0.873
iv	Knee point voltage	KVP : 2000 at 30mA	KVP : 2000 at 30mA	KVP : 1000 at 60mA	KVP : 1000 at 60mA	KVP : 1000 at 60mA	KVP : 1000 at 60mA	KVP : 1000 at 60mA	KVP : 1000 at 60mA	KVP : 200 at 250mA
Sr No	B-PH	1.1 Core I	1.1 Core II	1.1 Core III	1.2 Core I	1.2 Core II	2.1 Core I	2.1 Core II	2.1 Core III	3.1 Core 1
i	Ratio Adopted	600/1A	600/1A	600/1A	1000/1A	1000/1A	1000/1A	1000/1A	1000/1A	200/1
ii	Ratio measured	250	250	250	600	600	800	800	800	160
iii	error calculated	-0.403	-0.403	0.4	0.331	0.331	1.356	0.99	1.235	1.062
iv	Knee point voltage	KVP : 2000 at 30mA	KVP : 2000 at 30mA	KVP : 1000 at 60mA	KVP : 1000 at 60mA	KVP : 1000 at 60mA	KVP : 1000 at 60mA	KVP : 1000 at 60mA	KVP : 1000 at 60mA	KVP : 200 at 250mA



**Bajaj Energy Ltd, 3X660MW LPGCL, Lalitpur, Uttar Pradesh**

**Station- 765/220kV LPGCL Switchyard**

**Audit Year**

**Document Rev**

Document No- LPGCL-EMD/DP/36

2024

00

**TITLE: Internal Protection Audit of 765kV & 220kV Switchyard**

**A.49 Current transformer (CT-765kV)**

Location of CT : BR #01 (BCT)

Ratio Test Date : Mar-2016

Sr No	R-PH	1.1 Core I	1.1 Core II	1.1 Core III	1.1 Core IV	1.N Core II	1.N Core III	1.N Core IV	1.N Core V
i	Ratio Adopted	300/1A	300/1A	750/1A	750/1A	300/1A	Spare	2000/1A	2000/1A
ii	Ratio measured	300	300	300	300	273	Spare	276	2000
iii	error calculated	0.2	0.1	0.5	0.74	0.11	Spare	0.72	0.36
iv	Knee point voltage	KVp :300 at 200mA	KVp :300 at 200mA	NA	NA	KVp :300 at 200mA	KVp :300 at 200mA	KVp :3000 at 20mA	KVp :3000 at 20mA
Sr No	Y-PH	1.1 Core I	1.1 Core II	1.1 Core III	1.1 Core IV	1.N Core II	1.N Core III	1.N Core IV	1.N Core V
i	Ratio Adopted	300/1A	300/1A	750/1A	750/1A	300/1A	Spare	2000/1A	2000/1A
ii	Ratio measured	300	300	300	300	271	Spare	271	271
iii	error calculated	-0.81	-0.3	-1.27	-1.27	1.38	Spare	-1.12	0.37
iv	Knee point voltage	KVp :300 at 200mA	KVp :300 at 200mA	NA	NA	KVp :300 at 200mA	KVp :300 at 200mA	KVp :3000 at 20mA	KVp :3000 at 20mA
Sr No	B-PH	1.1 Core I	1.1 Core II	1.1 Core III	1.1 Core IV	1.N Core II	1.N Core III	1.N Core IV	1.N Core V
i	Ratio Adopted	300/1A	300/1A	750/1A	750/1A	300/1A	Spare	2000/1A	2000/1A
ii	Ratio measured	298	298	298	298	270	Spare	270	270
iii	error calculated	1.06	0.96	1.16	0.91	-0.9	Spare	0.74	0.74
iv	Knee point voltage	KVp :300 at 200mA	KVp :300 at 200mA	NA	NA	KVp :300 at 200mA	KVp :300 at 200mA	KVp :3000 at 20mA	KVp :3000 at 20mA



**Bajaj Energy Ltd, 3X660MW LPGCL, Lalitpur, Uttar Pradesh**

**Station- 765/220kV LPGCL Switchyard**

**Audit Year**

**Document Rev**

Document No- LPGCL-EMD/DP/36

2024

00

**TITLE: Internal Protection Audit of 765kV & 220kV Switchyard**

**A.50 Current transformer (CT-765kV)**

Location of CT : BR #02 (BCT)

Ratio Test Date : Dec-2021

Sr No	R-PH	1.1 Core I	1.1 Core II	1.1 Core III	1.1 Core IV	1.N Core II	1.N Core III	1.N Core IV	1.N Core V
i	Ratio Adopted	300/1A	300/1A	750/1A	750/1A	300/1A	Spare	2000/1A	2000/1A
ii	Ratio measured	300	300	600	600	300	Spare	1200	1200
iii	error calculated	-0.301	-0.2	-0.629	-0.503	-0.402	Spare	-0.334	-0.334
iv	Knee point voltage	KVp :300 at 200mA	KVp :300 at 200mA	NA	NA	KVp :300 at 200mA	KVp :300 at 200mA	KVp :3000 at 20mA	KVp :3000 at 20mA
Sr No	Y-PH	1.1 Core I	1.1 Core II	1.1 Core III	1.1 Core IV	1.N Core II	1.N Core III	1.N Core IV	1.N Core V
i	Ratio Adopted	300/1A	300/1A	750/1A	750/1A	300/1A	Spare	2000/1A	2000/1A
ii	Ratio measured	300	300	500	500	271	Spare	1200	1200
iii	error calculated	-0.4	0	-0.25	-0.1	-0.9	Spare	-0.33	-0.33
iv	Knee point voltage	KVp :300 at 200mA	KVp :300 at 200mA	NA	NA	KVp :300 at 200mA	KVp :300 at 200mA	KVp :3000 at 20mA	KVp :3000 at 20mA
Sr No	B-PH	1.1 Core I	1.1 Core II	1.1 Core III	1.1 Core IV	1.N Core II	1.N Core III	1.N Core IV	1.N Core V
i	Ratio Adopted	300/1A	300/1A	750/1A	750/1A	300/1A	Spare	2000/1A	2000/1A
ii	Ratio measured	300	300	600	600	300	Spare	1200	1200
iii	error calculated	0.17	0.01	0.05	0.05	0.2	Spare	0.16	0.17
iv	Knee point voltage	KVp :300 at 200mA	KVp :300 at 200mA	NA	NA	KVp :300 at 200mA	KVp :300 at 200mA	KVp :3000 at 20mA	KVp :3000 at 20mA



**Bajaj Energy Ltd, 3X660MW LPGCL, Lalitpur, Uttar Pradesh**

**Station- 765/220kV LPGCL Switchyard**

**Audit Year**

**Document Rev**

Document No- LPGCL-EMD/DP/36

2024

00

**TITLE: Internal Protection Audit of 765kV & 220kV Switchyard**

**A.51 Current transformer (CT-765kV)**

Location of CT : LR #01 (BCT)

Ratio Test Date : Mar-2016

Sr No	R-PH	1.1 Core I	1.1 Core II	1.1 Core III	1.1 Core IV	1.N Core II	1.N Core III	1.N Core IV	1.N Core V
i	Ratio Adopted	300/1A	300/1A	750/1A	750/1A	300/1A	300/1A	2000/1A	2000/1A
ii	Ratio measured	301	301	299	299	270	270	270	270
iii	error calculated	1.15	1.25	0.83	0.33	0.99	0.99	0.74	-1.5
iv	Knee point voltage	KVp :300 at 200mA	KVp :300 at 200mA	NA	NA	KVp :300 at 200mA	KVp :300 at 200mA	KVp :3000 at 20mA	KVp :3000 at 20mA
Sr No	Y-PH	1.1 Core I	1.1 Core II	1.1 Core III	1.1 Core IV	1.N Core II	1.N Core III	1.N Core IV	1.N Core V
i	Ratio Adopted	300/1A	300/1A	750/1A	750/1A	300/1A	300/1A	2000/1A	2000/1A
ii	Ratio measured	299	299	299	299	271	271	271	271
iii	error calculated	1.42	1.22	0.83	0.33	-1.73	-1.61	0.37	1.81
iv	Knee point voltage	KVp :300 at 200mA	KVp :300 at 200mA	NA	NA	KVp :300 at 200mA	KVp :300 at 200mA	KVp :3000 at 20mA	KVp :3000 at 20mA
Sr No	B-PH	1.1 Core I	1.1 Core II	1.1 Core III	1.1 Core IV	1.N Core II	1.N Core III	1.N Core IV	1.N Core V
i	Ratio Adopted	300/1A	300/1A	750/1A	750/1A	300/1A	300/1A	2000/1A	2000/1A
ii	Ratio measured	303	303	303	303	269	269	269	269
iii	error calculated	0.59	0	0.49	0.25	0.44	-0.11	-1.13	0.37
iv	Knee point voltage	KVp :300 at 200mA	KVp :300 at 200mA	NA	NA	KVp :300 at 200mA	KVp :300 at 200mA	KVp :3000 at 20mA	KVp :3000 at 20mA



**Bajaj Energy Ltd, 3X660MW LPGCL, Lalitpur, Uttar Pradesh**

**Station- 765/220kV LPGCL Switchyard**

**Audit Year**

**Document Rev**

Document No- LPGCL-EMD/DP/36

2024

00

**TITLE: Internal Protection Audit of 765kV & 220kV Switchyard**

**A.52 Current transformer (CT-765kV)**

Location of CT : GT #02 (BCT)

Ratio Test Date : Dec-2015

Sr No	R-PH	1.1 Core I	1.1 Core II	1.1 Core III	1.2 Core I	1.2 Core II	2.1 Core I	2.2 Core I
i	Ratio Adopted	1000/1A	1000/1A	2000/1A	1000/1A	1000/1A	15000/5A	15000/5A
ii	Ratio measured	1006	1006	2000	1000	1000	2996	2996
iii	error calculated	0.399	0.399	-0.399	0.1	-0.1	-1.891	-1.891
iv	Knee point voltage	VK/2 : 50Rct +110 at 30mA	VK/2 : 10Rct +50 at 30mA	KVP : 1000 at 60mA	-	VK/2 : 10Rct +50 at 30mA	VK/2 : 250Rct +500 at 150mA	VK/2 : 250Rct +500 at 150mA
Sr No	Y-PH	1.1 Core I	1.1 Core II	1.1 Core III	1.2 Core I	1.2 Core II	2.1 Core I	2.2 Core I
i	Ratio Adopted	1000/1A	1000/1A	2000/1A	1000/1A	1000/1A	15000/5A	15000/5A
ii	Ratio measured	1006	1006	2000	1000	1000	2996	2996
iii	error calculated	0.38	0.37	-0.390	0.1	-0.1	0.891	-0.99s
iv	Knee point voltage	VK/2 : 50Rct +110 at 30mA	VK/2 : 10Rct +50 at 30mA	KVP : 1000 at 60mA	-	VK/2 : 10Rct +50 at 30mA	VK/2 : 250Rct +500 at 150mA	VK/2 : 250Rct +500 at 150mA
Sr No	B-PH	1.1 Core I	1.1 Core II	1.1 Core III	1.2 Core I	1.2 Core II	2.1 Core I	2.2 Core I
i	Ratio Adopted	1000/1A	1000/1A	2000/1A	1000/1A	1000/1A	15000/5A	15000/5A
ii	Ratio measured	1002	998	2000	996	996	2390	2398
iii	error calculated	0.29	2.25	-0.3	0.7	0.7	0.91	0.91
iv	Knee point voltage	VK/2 : 50Rct +110 at 30mA	VK/2 : 10Rct +50 at 30mA	KVP : 1000 at 60mA	-	VK/2 : 10Rct +50 at 30mA	VK/2 : 250Rct +500 at 150mA	VK/2 : 250Rct +500 at 150mA





**Bajaj Energy Ltd, 3X660MW LPGCL, Lalitpur, Uttar Pradesh**

**Station- 765/220kV LPGCL Switchyard**

**Audit Year**

**Document Rev**

Document No- LPGCL-EMD/DP/36

2024

00

**TITLE: Internal Protection Audit of 765kV & 220kV Switchyard**

**A.53 Current transformer (CT-765kV)**

Location of CT : GT #03 (BCT)

Ratio Test Date : Dec-2015

Sr No	R-PH	1.1 Core I	1.1 Core II	1.1 Core III	1.2 Core I	1.2 Core II	2.1 Core I	2.2 Core I
i	Ratio Adopted	1000/1A	1000/1A	2000/1A	1000/1A	1000/1A	15000/5A	15000/5A
ii	Ratio measured	994	994	2000	1004	1004	2996	2970
iii	error calculated	-0.501	-0.799	0.2	-0.1	0	-2.187	3.06
iv	Knee point voltage	VK/2 : 50Rct +110 at 30mA	VK/2 : 10Rct +50 at 30mA	KVP : 1000 at 60mA	-	VK/2 : 10Rct +50 at 30mA	VK/2 : 250Rct +500 at 150mA	VK/2 : 250Rct +500 at 150mA
Sr No	Y-PH	1.1 Core I	1.1 Core II	1.1 Core III	1.2 Core I	1.2 Core II	2.1 Core I	2.2 Core I
i	Ratio Adopted	1000/1A	1000/1A	2000/1A	1000/1A	1000/1A	15000/5A	15000/5A
ii	Ratio measured	996	996	2000	1000	1000	2996	2970
iii	error calculated	-0.698	-0.797	-1.588	0.2004	0.2	-2.187	3.06
iv	Knee point voltage	VK/2 : 50Rct +110 at 30mA	VK/2 : 10Rct +50 at 30mA	KVP : 1000 at 60mA	-	VK/2 : 10Rct +50 at 30mA	VK/2 : 250Rct +500 at 150mA	VK/2 : 250Rct +500 at 150mA
Sr No	B-PH	1.1 Core I	1.1 Core II	1.1 Core III	1.2 Core I	1.2 Core II	2.1 Core I	2.2 Core I
i	Ratio Adopted	1000/1A	1000/1A	2000/1A	1000/1A	1000/1A	15000/5A	15000/5A
ii	Ratio measured	1002	998	2000	1000	1000	2406	2400
iii	error calculated	0.29	0.9	-0.3	0.39	0.29	1.77	0.31
iv	Knee point voltage	VK/2 : 50Rct +110 at 30mA	VK/2 : 10Rct +50 at 30mA	KVP : 1000 at 60mA	-	VK/2 : 10Rct +50 at 30mA	VK/2 : 250Rct +500 at 150mA	VK/2 : 250Rct +500 at 150mA



**Bajaj Energy Ltd, 3X660MW LPGCL, Lalitpur, Uttar Pradesh**

**Station- 765/220kV LPGCL Switchyard**

**Audit Year**

**Document Rev**

Document No- LPGCL-EMD/DP/36

2024

00

**TITLE: Internal Protection Audit of 765kV & 220kV Switchyard**

**B.1 Potential transformer (CVT-765kV)**

Location of PT : Bay 701 CVTG

Ratio Test Date : 18.03.2015

Balance Testing (Tan-delta , IR & Winding Resistance ) date : 28.11.2023

Sr No	R-PH (SI. No-37992003169)	Core I	Core II	Core III
i	Ratio Adopted	765kV/√3/110V/√3	765kV/√3/110V/√3	765kV/√3/110V/√3
ii	Ratio Measured	765kV/√3/110V/√3	765kV/√3/110V/√3	765kV/√3/110V/√3
iii	Error Calculated	0.23	0.28	0.18
Sr No	Y-PH (SI. No-37992003168)	Core I	Core II	Core III
i	Ratio Adopted	765kV/√3/110V/√3	765kV/√3/110V/√3	765kV/√3/110V/√3
ii	Ratio Measured	765kV/√3/110V/√3	765kV/√3/110V/√3	765kV/√3/110V/√3
iii	Error Calculated	0.48	0.53	0.53
Sr No	B-PH (SI. No-37992003167)	Core I	Core II	Core III
i	Ratio Adopted	765kV/√3/110V/√3	765kV/√3/110V/√3	765kV/√3/110V/√3
ii	Ratio Measured	765kV/√3/110V/√3	765kV/√3/110V/√3	765kV/√3/110V/√3
iii	Error Calculated	0.33	0.28	0.33

**B.2 Potential transformer (CVT-765kV)**

Location of PT : Bay 703 CVTT

Ratio Test Date : 09.05.2015

Balance Testing (Tan-delta , IR & Winding Resistance ) date : 29.11.2023

Sr No	R-PH (SI. No-37992002895)	Core I	Core II	Core III
i	Ratio Adopted	765kV/√3/110V/√3	765kV/√3/110V/√3	Spare
ii	Ratio Measured	765kV/√3/110V/√3	765kV/√3/110V/√3	Spare
iii	Error Calculated	-0.694	-0.906	Spare
Sr No	Y-PH (SI. No-37992002893)	Core I	Core II	Core III
i	Ratio Adopted	765kV/√3/110V/√3	765kV/√3/110V/√3	Spare
ii	Ratio Measured	765kV/√3/110V/√3	765kV/√3/110V/√3	Spare
iii	Error Calculated	-0.623	-0.906	Spare
Sr No	B-PH (SI. No-37992002894)	Core I	Core II	Core III
i	Ratio Adopted	765kV/√3/110V/√3	765kV/√3/110V/√3	Spare
ii	Ratio Measured	765kV/√3/110V/√3	765kV/√3/110V/√3	Spare
iii	Error Calculated	0.0064	-0.906	Spare



**Bajaj Energy Ltd, 3X660MW LPGCL, Lalitpur, Uttar Pradesh**

**Station- 765/220kV LPGCL Switchyard**

**Audit Year**

**Document Rev**

Document No- LPGCL-EMD/DP/36

2024

00

**TITLE: Internal Protection Audit of 765kV & 220kV Switchyard**

### B.3 Potential transformer (CVT-765kV)

Location of PT : Bay 706 CVTT

Ratio Test Date : 09.05.2015

Balance Testing (Tan-delta , IR & Winding Resistance ) date : 14.01.2023

Sr No	R-PH (SI. No-37992002891)	Core I	Core II	Core III
i	Ratio Adopted	765kV/√3/110V/√3	765kV/√3/110V/√3	Spare
ii	Ratio Measured	765kV/√3/110V/√3	765kV/√3/110V/√3	Spare
iii	Error Calculated	-0.694	-0.906	Spare
Sr No	Y-PH (SI. No-37992002892)	Core I	Core II	Core III
i	Ratio Adopted	765kV/√3/110V/√3	765kV/√3/110V/√3	Spare
ii	Ratio Measured	765kV/√3/110V/√3	765kV/√3/110V/√3	Spare
iii	Error Calculated	-0.623	-0.906	Spare
Sr No	B-PH (SI. No-37992002890)	Core I	Core II	Core III
i	Ratio Adopted	765kV/√3/110V/√3	765kV/√3/110V/√3	Spare
ii	Ratio Measured	765kV/√3/110V/√3	765kV/√3/110V/√3	Spare
iii	Error Calculated	-0.694	-0.906	Spare

### B.4 Potential transformer (CVT-765kV)

Location of PT : Bay 707 CVTG

Ratio Test Date : 13.07.2015

Balance Testing (Tan-delta , IR & Winding Resistance ) date : 06.02.2023

Sr No	R-PH (SI. No-37992003214)	Core I	Core II	Core III
i	Ratio Adopted	765kV/√3/110V/√3	765kV/√3/110V/√3	765kV/√3/110V/√3
ii	Ratio Measured	765kV/√3/110V/√3	765kV/√3/110V/√3	765kV/√3/110V/√3
iii	Error Calculated	-0.482	-0.482	-0.412
Sr No	Y-PH (SI. No-37992003215)	Core I	Core II	Core III
i	Ratio Adopted	765kV/√3/110V/√3	765kV/√3/110V/√3	765kV/√3/110V/√3
ii	Ratio Measured	765kV/√3/110V/√3	765kV/√3/110V/√3	765kV/√3/110V/√3
iii	Error Calculated	-0.272	-0.412	-0.482
Sr No	B-PH (SI. No-37992003221)	Core I	Core II	Core III
i	Ratio Adopted	765kV/√3/110V/√3	765kV/√3/110V/√3	765kV/√3/110V/√3
ii	Ratio Measured	765kV/√3/110V/√3	765kV/√3/110V/√3	765kV/√3/110V/√3
iii	Error Calculated	-0.482	-0.412	-0.342



**Bajaj Energy Ltd, 3X660MW LPGCL, Lalitpur, Uttar Pradesh**

**Station- 765/220kV LPGCL Switchyard**

**Audit Year**

**Document Rev**

Document No- LPGCL-EMD/DP/36

2024

00

**TITLE: Internal Protection Audit of 765kV & 220kV Switchyard**

### B.5 Potential transformer (CVT-765kV)

Location of PT : Bay 709 CVTL

Ratio Test Date : 01.08.2015

Balance Testing (Tan-delta , IR & Winding Resistance ) date : 27.11.2020

Sr No	R-PH (Sl. No-37992002704)	Core I	Core II	Core III
i	Ratio Adopted	765kV/√3/110V/√3	765kV/√3/110V/√3	765kV/√3/110V/√3
ii	Ratio Measured	765kV/√3/110V/√3	765kV/√3/110V/√3	765kV/√3/110V/√3
iii	Error Calculated	-0.481	-0.482	-0.412
Sr No	Y-PH (Sl. No-37992003194)	Core I	Core II	Core III
i	Ratio Adopted	765kV/√3/110V/√3	765kV/√3/110V/√3	765kV/√3/110V/√3
ii	Ratio Measured	765kV/√3/110V/√3	765kV/√3/110V/√3	765kV/√3/110V/√3
iii	Error Calculated	-0.273	-0.412	-0.482
Sr No	B-PH (Sl. No-37992003192)	Core I	Core II	Core III
i	Ratio Adopted	765kV/√3/110V/√3	765kV/√3/110V/√3	765kV/√3/110V/√3
ii	Ratio Measured	765kV/√3/110V/√3	765kV/√3/110V/√3	765kV/√3/110V/√3
iii	Error Calculated	-0.482	-0.412	-0.341

### B.6 Potential transformer (CVT-765kV)

Location of PT : Bay 709 MCVTL

Ratio Test Date : 31.07.2015

Balance Testing (Tan-delta , IR & Winding Resistance ) date : 27.11.2020

Sr No	R-PH (Sl. No-37992002889)	Core I	Core II	Core III
i	Ratio Adopted	765kV/√3/110V/√3	765kV/√3/110V/√3	Spare
ii	Ratio Measured	765kV/√3/110V/√3	765kV/√3/110V/√3	Spare
iii	Error Calculated	-0.553	-0.482	Spare
Sr No	Y-PH (Sl. No-37992002896)	Core I	Core II	Core III
i	Ratio Adopted	765kV/√3/110V/√3	765kV/√3/110V/√3	Spare
ii	Ratio Measured	765kV/√3/110V/√3	765kV/√3/110V/√3	Spare
iii	Error Calculated	-0.272	-0.412	Spare
Sr No	B-PH (Sl. No-37992002886)	Core I	Core II	Core III
i	Ratio Adopted	765kV/√3/110V/√3	765kV/√3/110V/√3	Spare
ii	Ratio Measured	765kV/√3/110V/√3	765kV/√3/110V/√3	Spare
iii	Error Calculated	-0.482	-0.412	Spare



**Bajaj Energy Ltd, 3X660MW LPGCL, Lalitpur, Uttar Pradesh**

**Station- 765/220kV LPGCL Switchyard**

**Audit Year**

**Document Rev**

Document No- LPGCL-EMD/DP/36

2024

00

**TITLE: Internal Protection Audit of 765kV & 220kV Switchyard**

### B.7 Potential transformer (CVT-765kV)

Location of PT : Bay 710 CVTG

Ratio Test Date : 13.07.2015

Balance Testing (Tan-delta , IR & Winding Resistance ) date : 17.01.2023

Sr No	R-PH (Sl. No-37992003219)	Core I	Core II	Core III
i	Ratio Adopted	765kV/√3/110V/√3	765kV/√3/110V/√3	765kV/√3/110V/√3
ii	Ratio Measured	765kV/√3/110V/√3	765kV/√3/110V/√3	765kV/√3/110V/√3
iii	Error Calculated	-0.482	-0.342	-0.412
Sr No	Y-PH (Sl. No-37992003220)	Core I	Core II	Core III
i	Ratio Adopted	765kV/√3/110V/√3	765kV/√3/110V/√3	765kV/√3/110V/√3
ii	Ratio Measured	765kV/√3/110V/√3	765kV/√3/110V/√3	765kV/√3/110V/√3
iii	Error Calculated	-0.342	-0.412	-0.482
Sr No	B-PH (Sl. No-37992003218)	Core I	Core II	Core III
i	Ratio Adopted	765kV/√3/110V/√3	765kV/√3/110V/√3	765kV/√3/110V/√3
ii	Ratio Measured	765kV/√3/110V/√3	765kV/√3/110V/√3	765kV/√3/110V/√3
iii	Error Calculated	-0.482	-0.412	-0.342

### B.8 Potential transformer (CVT-765kV)

Location of PT : Bay 712 CVTL

Ratio Test Date : 01.08.2015

Balance Testing (Tan-delta , IR & Winding Resistance ) date : 25.11.2020

Sr No	R-PH (Sl. No-37992002703)	Core I	Core II	Core III
i	Ratio Adopted	765kV/√3/110V/√3	765kV/√3/110V/√3	765kV/√3/110V/√3
ii	Ratio Measured	765kV/√3/110V/√3	765kV/√3/110V/√3	765kV/√3/110V/√3
iii	Error Calculated	-0.482	-0.482	-0.412
Sr No	Y-PH (Sl. No-37992003193)	Core I	Core II	Core III
i	Ratio Adopted	765kV/√3/110V/√3	765kV/√3/110V/√3	765kV/√3/110V/√3
ii	Ratio Measured	765kV/√3/110V/√3	765kV/√3/110V/√3	765kV/√3/110V/√3
iii	Error Calculated	-0.272	-0.412	-0.482
Sr No	B-PH (Sl. No-37992000016)	Core I	Core II	Core III
i	Ratio Adopted	765kV/√3/110V/√3	765kV/√3/110V/√3	765kV/√3/110V/√3
ii	Ratio Measured	765kV/√3/110V/√3	765kV/√3/110V/√3	765kV/√3/110V/√3
iii	Error Calculated	-0.482	-0.412	-0.342



**Bajaj Energy Ltd, 3X660MW LPGCL, Lalitpur, Uttar Pradesh**

**Station- 765/220kV LPGCL Switchyard**

**Audit Year**

**Document Rev**

Document No- LPGCL-EMD/DP/36

2024

00

**TITLE: Internal Protection Audit of 765kV & 220kV Switchyard**

### B.9 Potential transformer (CVT-765kV)

Location of PT : Bay 712 MCVTL

Ratio Test Date : 01.08.2015

Balance Testing (Tan-delta , IR & Winding Resistance ) date : 25.11.2020

Sr No	R-PH (Sl. No-37992002884)	Core I	Core II	Core III
i	Ratio Adopted	765kV/√3/110V/√3	765kV/√3/110V/√3	Spare
ii	Ratio Measured	765kV/√3/110V/√3	765kV/√3/110V/√3	Spare
iii	Error Calculated	-0.482	-0.482	Spare
Sr No	Y-PH (Sl. No-37992002887)	Core I	Core II	Core III
i	Ratio Adopted	765kV/√3/110V/√3	765kV/√3/110V/√3	Spare
ii	Ratio Measured	765kV/√3/110V/√3	765kV/√3/110V/√3	Spare
iii	Error Calculated	-0.412	-0.482	Spare
Sr No	B-PH (Sl. No-37992002888)	Core I	Core II	Core III
i	Ratio Adopted	765kV/√3/110V/√3	765kV/√3/110V/√3	Spare
ii	Ratio Measured	765kV/√3/110V/√3	765kV/√3/110V/√3	Spare
iii	Error Calculated	-0.482	-0.412	Spare

### B.10 Potential transformer (CVT-765kV)

Location of PT : 7BB1 CVT

Ratio Test Date : 17.03.2015

Balance Testing (Tan-delta , IR & Winding Resistance ) date : 09.12.2021

Sr No	R-PH (Sl. No-37992003217)	Core I	Core II	Core III
i	Ratio Adopted	765kV/√3/110V/√3	765kV/√3/110V/√3	765kV/√3/110V/√3
ii	Ratio Measured	765kV/√3/110V/√3	765kV/√3/110V/√3	765kV/√3/110V/√3
iii	Error Calculated	0.28	0.28	0.28
Sr No	Y-PH (Sl. No-37992003170)	Core I	Core II	Core III
i	Ratio Adopted	765kV/√3/110V/√3	765kV/√3/110V/√3	765kV/√3/110V/√3
ii	Ratio Measured	765kV/√3/110V/√3	765kV/√3/110V/√3	765kV/√3/110V/√3
iii	Error Calculated	0.43	0.38	0.43
Sr No	B-PH (Sl. No-37992003216)	Core Is	Core II	Core III
i	Ratio Adopted	765kV/√3/110V/√3	765kV/√3/110V/√3	765kV/√3/110V/√3
ii	Ratio Measured	765kV/√3/110V/√3	765kV/√3/110V/√3	765kV/√3/110V/√3
iii	Error Calculated	0.33	0.28	0.33



**Bajaj Energy Ltd, 3X660MW LPGCL, Lalitpur, Uttar Pradesh**

**Station- 765/220kV LPGCL Switchyard**

**Audit Year**

**Document Rev**

Document No- LPGCL-EMD/DP/36

2024

00

**TITLE: Internal Protection Audit of 765kV & 220kV Switchyard**

### B.11 Potential transformer (CVT-765kV)

Location of PT : 7BB2 CVT

Ratio Test Date : 18.03.2015

Balance Testing (Tan-delta , IR & Winding Resistance ) date : 08.12.2021

Sr No	R-PH (Sl. No-37992003164)	Core I	Core II	Core III
i	Ratio Adopted	765kV/√3/110V/√3	765kV/√3/110V/√3	765kV/√3/110V/√3
ii	Ratio Measured	765kV/√3/110V/√3	765kV/√3/110V/√3	765kV/√3/110V/√3
iii	Error Calculated	0.33	0.28	0.33
Sr No	Y-PH (Sl. No-37992003165)	Core I	Core II	Core III
i	Ratio Adopted	765kV/√3/110V/√3	765kV/√3/110V/√3	765kV/√3/110V/√3
ii	Ratio Measured	765kV/√3/110V/√3	765kV/√3/110V/√3	765kV/√3/110V/√3
iii	Error Calculated	0.28	0.33	0.28
Sr No	B-PH (Sl. No-37992003166)	Core I	Core II	Core III
i	Ratio Adopted	765kV/√3/110V/√3	765kV/√3/110V/√3	765kV/√3/110V/√3
ii	Ratio Measured	765kV/√3/110V/√3	765kV/√3/110V/√3	765kV/√3/110V/√3
iii	Error Calculated	0.63	0.43	0.53

### B.12 Potential transformer (CVT-220kV)

Location of PT : 202 CVT

Ratio Test Date : 21.01.2014

Balance Testing (Tan-delta , IR & Winding Resistance ) date : 08.04.2024

Sr No	R-PH (Sl. No-1303A0398)	Core I	Core II	Core III
i	Ratio Adopted	220kV/√3/110V/√3	220kV/√3/110V/√3	220kV/√3/110V/√3
ii	Ratio Measured	220kV/√3/110V/√3	220kV/√3/110V/√3	220kV/√3/110V/√3
iii	Error Calculated	0.4	0.2	0
Sr No	Y-PH (Sl. No-1303A0392)	Core I	Core II	Core III
i	Ratio Adopted	220kV/√3/110V/√3	220kV/√3/110V/√3	220kV/√3/110V/√3
ii	Ratio Measured	220kV/√3/110V/√3	220kV/√3/110V/√3	220kV/√3/110V/√3
iii	Error Calculated	0.2	0.4	0.2
Sr No	B-PH (Sl. No-1303A0381)	Core I	Core II	Core III
i	Ratio Adopted	220kV/√3/110V/√3	220kV/√3/110V/√3	220kV/√3/110V/√3
ii	Ratio Measured	220kV/√3/110V/√3	220kV/√3/110V/√3	220kV/√3/110V/√3
iii	Error Calculated	0.2	0	0.4



**Bajaj Energy Ltd, 3X660MW LPGCL, Lalitpur, Uttar Pradesh**

**Station- 765/220kV LPGCL Switchyard**

**Audit Year**

**Document Rev**

Document No- LPGCL-EMD/DP/36

2024

00

**TITLE: Internal Protection Audit of 765kV & 220kV Switchyard**

### B.13 Potential transformer (CVT-220kV)

Location of PT : 203 CVT

Ratio Test Date : 21.01.2014

Balance Testing (Tan-delta , IR & Winding Resistance ) date : 16.04.2024

Sr No	R-PH (Sl. No-1303A0387)	Core I	Core II	Core III
i	Ratio Adopted	220kV/√3/110V/√3	220kV/√3/110V/√3	220kV/√3/110V/√3
ii	Ratio Measured	220kV/√3/110V/√3	220kV/√3/110V/√3	220kV/√3/110V/√3
iii	Error Calculated	0	0	0
Sr No	Y-PH (Sl. No-1303A0397)	Core I	Core II	Core III
i	Ratio Adopted	220kV/√3/110V/√3	220kV/√3/110V/√3	220kV/√3/110V/√3
ii	Ratio Measured	220kV/√3/110V/√3	220kV/√3/110V/√3	220kV/√3/110V/√3
iii	Error Calculated	0	0	0
Sr No	B-PH (Sl. No-1303A0395)	Core I	Core II	Core III
i	Ratio Adopted	220kV/√3/110V/√3	220kV/√3/110V/√3	220kV/√3/110V/√3
ii	Ratio Measured	220kV/√3/110V/√3	220kV/√3/110V/√3	220kV/√3/110V/√3
iii	Error Calculated	0	0	0

### B.14 Potential transformer (CVT-220kV)

Location of PT : 207 CVT

Ratio Test Date : 16.01.2014

Balance Testing (Tan-delta , IR & Winding Resistance ) date : 08.10.2018

Sr No	R-PH (Sl. No-1303A0384)	Core I	Core II	Core III
i	Ratio Adopted	220kV/√3/110V/√3	220kV/√3/110V/√3	220kV/√3/110V/√3
ii	Ratio Measured	220kV/√3/110V/√3	220kV/√3/110V/√3	220kV/√3/110V/√3
iii	Error Calculated	0.2	0.2	0.4
Sr No	Y-PH (Sl. No-1303A0383)	Core I	Core II	Core III
i	Ratio Adopted	220kV/√3/110V/√3	220kV/√3/110V/√3	220kV/√3/110V/√3
ii	Ratio Measured	220kV/√3/110V/√3	220kV/√3/110V/√3	220kV/√3/110V/√3
iii	Error Calculated	0.2	0.2	0.2
Sr No	B-PH (Sl. No-1303A0389)	Core I	Core II	Core III
i	Ratio Adopted	220kV/√3/110V/√3	220kV/√3/110V/√3	220kV/√3/110V/√3
ii	Ratio Measured	220kV/√3/110V/√3	220kV/√3/110V/√3	220kV/√3/110V/√3
iii	Error Calculated	0.2	0	0





**Bajaj Energy Ltd, 3X660MW LPGCL, Lalitpur, Uttar Pradesh**

**Station- 765/220kV LPGCL Switchyard**

**Audit Year**

**Document Rev**

Document No- LPGCL-EMD/DP/36

2024

00

**TITLE: Internal Protection Audit of 765kV & 220kV Switchyard**

### B.15 Potential transformer (CVT-220kV)

Location of PT : 208 CVT

Ratio Test Date : 16.01.2014

Balance Testing (Tan-delta , IR & Winding Resistance ) date : 12.11.2021

Sr No	R-PH (Sl. No-1303A0394)	Core I	Core II	Core III
i	Ratio Adopted	220kV/√3/110V/√3	220kV/√3/110V/√3	220kV/√3/110V/√3
ii	Ratio Measured	220kV/√3/110V/√3	220kV/√3/110V/√3	220kV/√3/110V/√3
iii	Error Calculated	0.2	-0.2	0
Sr No	Y-PH (Sl. No-1303A0388)	Core I	Core II	Core III
i	Ratio Adopted	220kV/√3/110V/√3	220kV/√3/110V/√3	220kV/√3/110V/√3
ii	Ratio Measured	220kV/√3/110V/√3	220kV/√3/110V/√3	220kV/√3/110V/√3
iii	Error Calculated	-0.2	-0.2	0
Sr No	B-PH (Sl. No-1303A0390)	Core I	Core II	Core III
i	Ratio Adopted	220kV/√3/110V/√3	220kV/√3/110V/√3	220kV/√3/110V/√3
ii	Ratio Measured	220kV/√3/110V/√3	220kV/√3/110V/√3	220kV/√3/110V/√3
iii	Error Calculated	0.2	0.4	0.2

### B.16 Potential transformer (CVT-220kV)

Location of PT : 2BB1 CVT

Ratio Test Date : 20.01.2014

Balance Testing (Tan-delta , IR & Winding Resistance ) date : 16.01.2023

Sr No	R-PH (Sl. No-1303A0399)	Core I	Core II	Core III
i	Ratio Adopted	220kV/√3/110V/√3	220kV/√3/110V/√3	220kV/√3/110V/√3
ii	Ratio Measured	220kV/√3/110V/√3	220kV/√3/110V/√3	220kV/√3/110V/√3
iii	Error Calculated	0	0	0
Sr No	Y-PH (Sl. No-1303A0369)	Core I	Core II	Core III
i	Ratio Adopted	220kV/√3/110V/√3	220kV/√3/110V/√3	220kV/√3/110V/√3
ii	Ratio Measured	220kV/√3/110V/√3	220kV/√3/110V/√3	220kV/√3/110V/√3
iii	Error Calculated	0	0	0
Sr No	B-PH (Sl. No-1303A0385)	Core I	Core II	Core III
i	Ratio Adopted	220kV/√3/110V/√3	220kV/√3/110V/√3	220kV/√3/110V/√3
ii	Ratio Measured	220kV/√3/110V/√3	220kV/√3/110V/√3	220kV/√3/110V/√3
iii	Error Calculated	0	0	0



**Bajaj Energy Ltd, 3X660MW LPGCL, Lalitpur, Uttar Pradesh**

**Station- 765/220kV LPGCL Switchyard**

**Audit Year**

**Document Rev**

Document No- LPGCL-EMD/DP/36

2024

00

**TITLE: Internal Protection Audit of 765kV & 220kV Switchyard**

### B.17 Potential transformer (CVT-220kV)

Location of PT : 2BB2 CVT

Ratio Test Date : 20.01.2014

Balance Testing (Tan-delta , IR & Winding Resistance ) date : 25.11.2023

Sr No	R-PH (SI. No-1303A0391)	Core I	Core II	Core III
i	Ratio Adopted	220kV/V3/110V/V3	220kV/V3/110V/V3	220kV/V3/110V/V3
ii	Ratio Measured	220kV/V3/110V/V3	220kV/V3/110V/V3	220kV/V3/110V/V3
iii	Error Calculated	0	0	0
Sr No	Y-PH (SI. No-1303A0382)	Core I	Core II	Core III
i	Ratio Adopted	220kV/V3/110V/V3	220kV/V3/110V/V3	220kV/V3/110V/V3
ii	Ratio Measured	220kV/V3/110V/V3	220kV/V3/110V/V3	220kV/V3/110V/V3
iii	Error Calculated	0	0	0
Sr No	B-PH (SI. No-1303A0393)	Core I	Core II	Core III
i	Ratio Adopted	220kV/V3/110V/V3	220kV/V3/110V/V3	220kV/V3/110V/V3
ii	Ratio Measured	220kV/V3/110V/V3	220kV/V3/110V/V3	220kV/V3/110V/V3
iii	Error Calculated	0	0	0

### B.18 Potential transformer (EMVT-220kV)

Location of PT : 201 EMVT

Ratio Test Date : 30.01.2014

Balance Testing (Tan-delta , IR & Winding Resistance ) date : 30.01.2014

Sr No	R-PH (SI. No-OP4712/1R/21/13)	Core I	Core II	Core III
i	Ratio Adopted	220kV/V3/110V/V3	220kV/V3/110V/V3	220kV/V3/110V/V3
ii	Ratio Measured	220kV/V3/110V/V3	220kV/V3/110V/V3	220kV/V3/110V/V3
iii	Error Calculated	0	0	0
Sr No	Y-PH (SI. No-OP4712/1R/23/13)	Core I	Core II	Core III
i	Ratio Adopted	220kV/V3/110V/V3	220kV/V3/110V/V3	220kV/V3/110V/V3
ii	Ratio Measured	220kV/V3/110V/V3	220kV/V3/110V/V3	220kV/V3/110V/V3
iii	Error Calculated	0	-0.2	-0.2
Sr No	B-PH (SI. No-OP4712/1R/13/13)	Core I	Core II	Core III
i	Ratio Adopted	220kV/V3/110V/V3	220kV/V3/110V/V3	220kV/V3/110V/V3
ii	Ratio Measured	220kV/V3/110V/V3	220kV/V3/110V/V3	220kV/V3/110V/V3
iii	Error Calculated	-0.2	0	-0.4



**Bajaj Energy Ltd, 3X660MW LPGCL, Lalitpur, Uttar Pradesh**

**Station- 765/220kV LPGCL Switchyard**

**Audit Year**

**Document Rev**

Document No- LPGCL-EMD/DP/36

2024

00

**TITLE: Internal Protection Audit of 765kV & 220kV Switchyard**

### B.19 Potential transformer (EMVT-220kV)

Location of PT : 202 EMVT

Ratio Test Date : 30.01.2014

Balance Testing (Tan-delta , IR & Winding Resistance ) date : 30.01.2014

Sr No	R-PH (Sl. No-OP4712/1R/18/13)	Core I	Core II	Core III
i	Ratio Adopted	220kV/√3/110V/√3	220kV/√3/110V/√3	Spare
ii	Ratio Measured	220kV/√3/110V/√3	220kV/√3/110V/√3	Spare
iii	Error Calculated	0	-0.2	Spare
Sr No	Y-PH (Sl. No-OP4712/1R/15/13)	Core I	Core II	Core III
i	Ratio Adopted	220kV/√3/110V/√3	220kV/√3/110V/√3	Spare
ii	Ratio Measured	220kV/√3/110V/√3	220kV/√3/110V/√3	Spare
iii	Error Calculated	0	-0.2	Spare
Sr No	B-PH (Sl. No-OP4712/1R/02/13)	Core I	Core II	Core III
i	Ratio Adopted	220kV/√3/110V/√3	220kV/√3/110V/√3	Spare
ii	Ratio Measured	220kV/√3/110V/√3	220kV/√3/110V/√3	Spare
iii	Error Calculated	-0.2	-0.2	Spare

### B.20 Potential transformer (EMVT-220kV)

Location of PT: 203 EMVT

Ratio Test Date: 30.01.2014

Balance Testing (Tan-delta, IR & Winding Resistance) date: 30.01.2014

Sr No	R-PH (Sl. No-OP4712/1R/20/13)	Core I	Core II	Core III
i	Ratio Adopted	220kV/√3/110V/√3	220kV/√3/110V/√3	Spare
ii	Ratio Measured	220kV/√3/110V/√3	220kV/√3/110V/√3	Spare
iii	Error Calculated	0	0	Spare
Sr No	Y-PH (Sl. No-OP4712/1R/25/13)	Core I	Core II	Core III
i	Ratio Adopted	220kV/√3/110V/√3	220kV/√3/110V/√3	Spare
ii	Ratio Measured	220kV/√3/110V/√3	220kV/√3/110V/√3	Spare
iii	Error Calculated	-0.2	-0.4	Spare
Sr No	B-PH (Sl. No-OP4712/1R/04/13)	Core I	Core II	Core III
i	Ratio Adopted	220kV/√3/110V/√3	220kV/√3/110V/√3	Spare
ii	Ratio Measured	220kV/√3/110V/√3	220kV/√3/110V/√3	Spare
iii	Error Calculated	-0.2	0	Spare



**Bajaj Energy Ltd, 3X660MW LPGCL, Lalitpur, Uttar Pradesh**

**Station- 765/220kV LPGCL Switchyard**

**Audit Year**

**Document Rev**

Document No- LPGCL-EMD/DP/36

2024

00

**TITLE: Internal Protection Audit of 765kV & 220kV Switchyard**

### B.21 Potential transformer (EMVT-220kV)

Location of PT: 204 EMVT

Ratio Test Date: 22.01.2014

Balance Testing (Tan-delta, IR & Winding Resistance) date: 23.11.2023

Sr No	R-PH (SI. No-OP4712/1/14/13)	Core I	Core II	Core III
i	Ratio Adopted	220kV/√3/110V/√3	220kV/√3/110V/√3	220kV/√3/110V/√3
ii	Ratio Measured	220kV/√3/110V/√3	220kV/√3/110V/√3	220kV/√3/110V/√3
iii	Error Calculated	0	-0.4	-0.6
Sr No	Y-PH (SI. No-OP4712/1/24/13)	Core I	Core II	Core III
i	Ratio Adopted	220kV/√3/110V/√3	220kV/√3/110V/√3	220kV/√3/110V/√3
ii	Ratio Measured	220kV/√3/110V/√3	220kV/√3/110V/√3	220kV/√3/110V/√3
iii	Error Calculated	0	0	0
Sr No	B-PH (SI. No-OP4712/1/11/13)	Core I	Core II	Core III
i	Ratio Adopted	220kV/√3/110V/√3	220kV/√3/110V/√3	220kV/√3/110V/√3
ii	Ratio Measured	220kV/√3/110V/√3	220kV/√3/110V/√3	220kV/√3/110V/√3
iii	Error Calculated	0	-0.2	0

### B.22 Potential transformer (EMVT-220kV)

Location of PT: 207 EMVT

Ratio Test Date: 18.01.2014

Balance Testing (Tan-delta, IR & Winding Resistance) date: 16.01.2014

Sr No	R-PH (SI. No-OP4712/1/08/13)	Core I	Core II	Core III
i	Ratio Adopted	220kV/√3/110V/√3	220kV/√3/110V/√3	Spare
ii	Ratio Measured	220kV/√3/110V/√3	220kV/√3/110V/√3	Spare
iii	Error Calculated	0.2	0.2	Spare
Sr No	Y-PH (SI. No-OP4712/1/17/13)	Core I	Core II	Core III
i	Ratio Adopted	220kV/√3/110V/√3	220kV/√3/110V/√3	Spare
ii	Ratio Measured	220kV/√3/110V/√3	220kV/√3/110V/√3	Spare
iii	Error Calculated	0	0.4	Spare
Sr No	B-PH (SI. No-OP4712/1/05/13)	Core I	Core II	Core III
i	Ratio Adopted	220kV/√3/110V/√3	220kV/√3/110V/√3	Spare
ii	Ratio Measured	220kV/√3/110V/√3	220kV/√3/110V/√3	Spare
iii	Error Calculated	-0.2	0	Spare



**Bajaj Energy Ltd, 3X660MW LPGCL, Lalitpur, Uttar Pradesh**

**Station- 765/220kV LPGCL Switchyard**

**Audit Year**

**Document Rev**

Document No- LPGCL-EMD/DP/36

2024

00

**TITLE: Internal Protection Audit of 765kV & 220kV Switchyard**

### B.23 Potential transformer (EMVT-220kV)

Location of PT: 208 EMVT

Ratio Test Date: 15.01.2014

Balance Testing (Tan-delta, IR & Winding Resistance) date: 15.01.2014

Sr No	R-PH (Sl. No-OP4712/1/07/13)	Core I	Core II	Core III
i	Ratio Adopted	220kV/√3/110V/√3	220kV/√3/110V/√3	Spare
ii	Ratio Measured	220kV/√3/110V/√3	220kV/√3/110V/√3	Spare
iii	Error Calculated	0.67	0.33	Spare
Sr No	Y-PH (Sl. No-OP4712/1/06/13)	Core I	Core II	Core III
i	Ratio Adopted	220kV/√3/110V/√3	220kV/√3/110V/√3	Spare
ii	Ratio Measured	220kV/√3/110V/√3	220kV/√3/110V/√3	Spare
iii	Error Calculated	-0.33	-0.67	Spare
Sr No	B-PH (Sl. No-OP4712/1/01/13)	Core I	Core II	Core III
i	Ratio Adopted	220kV/√3/110V/√3	220kV/√3/110V/√3	Spare
ii	Ratio Measured	220kV/√3/110V/√3	220kV/√3/110V/√3	Spare
iii	Error Calculated	0	0.33	Spare

### B.24 Potential transformer (EMVT-220kV)

Location of PT: 209 EMVT

Ratio Test Date: 14.01.2014

Balance Testing (Tan-delta, IR & Winding Resistance) date: 14.01.2014

Sr No	R-PH (Sl. No-OP4712/1/09/13)	Core I	Core II	Core III
i	Ratio Adopted	220kV/√3/110V/√3	220kV/√3/110V/√3	220kV/√3/110V/√3
ii	Ratio Measured	220kV/√3/110V/√3	220kV/√3/110V/√3	220kV/√3/110V/√3
iii	Error Calculated	YES	YES	YES
Sr No	Y-PH (Sl. No-OP4712/1/10/13)	Core I	Core II	Core III
i	Ratio Adopted	220kV/√3/110V/√3	220kV/√3/110V/√3	220kV/√3/110V/√3
ii	Ratio Measured	220kV/√3/110V/√3	220kV/√3/110V/√3	220kV/√3/110V/√3
iii	Error Calculated	0.2	0	0.2
Sr No	B-PH (Sl. No-OP4712/1/12/13)	Core I	Core II	Core III
i	Ratio Adopted	220kV/√3/110V/√3	220kV/√3/110V/√3	220kV/√3/110V/√3
ii	Ratio Measured	220kV/√3/110V/√3	220kV/√3/110V/√3	220kV/√3/110V/√3
iii	Error Calculated	0.2	0.2	0.2



**Bajaj Energy Ltd, 3X660MW LPGCL, Lalitpur, Uttar Pradesh**

**Station- 765/220kV LPGCL Switchyard**

**Audit Year**

**Document Rev**

Document No- LPGCL-EMD/DP/36

2024

00

**TITLE: Internal Protection Audit of 765kV & 220kV Switchyard**

### B.25 Potential transformer (EMVT-220kV)

Location of PT: 210 EMVT

Ratio Test Date: 14.01.2014

Balance Testing (Tan-delta, IR & Winding Resistance) date: 14.01.2014

Sr No	R-PH (Sl. No-OP4712/1/22/13)	Core I	Core II	Core III
i	Ratio Adopted	220kV/ $\sqrt{3}$ /110V/ $\sqrt{3}$	220kV/ $\sqrt{3}$ /110V/ $\sqrt{3}$	220kV/ $\sqrt{3}$ /110V/ $\sqrt{3}$
ii	Ratio Measured	220kV/ $\sqrt{3}$ /110V/ $\sqrt{3}$	220kV/ $\sqrt{3}$ /110V/ $\sqrt{3}$	220kV/ $\sqrt{3}$ /110V/ $\sqrt{3}$
iii	Error Calculated	0.2	0	0
Sr No	Y-PH (Sl. No-OP4712/1/19/13)	Core I	Core II	Core III
i	Ratio Adopted	220kV/ $\sqrt{3}$ /110V/ $\sqrt{3}$	220kV/ $\sqrt{3}$ /110V/ $\sqrt{3}$	220kV/ $\sqrt{3}$ /110V/ $\sqrt{3}$
ii	Ratio Measured	220kV/ $\sqrt{3}$ /110V/ $\sqrt{3}$	220kV/ $\sqrt{3}$ /110V/ $\sqrt{3}$	220kV/ $\sqrt{3}$ /110V/ $\sqrt{3}$
iii	Error Calculated	0	-0.2	0
Sr No	B-PH (Sl. No-OP4712/1/16/13)	Core I	Core II	Core III
i	Ratio Adopted	220kV/ $\sqrt{3}$ /110V/ $\sqrt{3}$	220kV/ $\sqrt{3}$ /110V/ $\sqrt{3}$	220kV/ $\sqrt{3}$ /110V/ $\sqrt{3}$
ii	Ratio Measured	220kV/ $\sqrt{3}$ /110V/ $\sqrt{3}$	220kV/ $\sqrt{3}$ /110V/ $\sqrt{3}$	220kV/ $\sqrt{3}$ /110V/ $\sqrt{3}$
iii	Error Calculated	0	0	0



**Bajaj Energy Ltd, 3X660MW LPGCL, Lalitpur, Uttar Pradesh**

**Station- 765/220kV LPGCL Switchyard**

**Audit Year**

**Document Rev**

Document No- LPGCL-EMD/DP/36

2024

00

**TITLE: Internal Protection Audit of 765kV & 220kV Switchyard**

### 3) Availability of Protection System

#### A) Bus Bar relay

Sr No.		765kV	220kV
i)	Make and Model of Bus Bar relay	Make- Schneider, Model -P743 & P741	Make- Schneider, Model -P743 & P741
ii)	Whether stability checks done or not	Done	Done
iii)	Date of testing	May-2016	Feb-2014
iv)	Remarks (if any)	Tested During Commissioning Only.	Tested During Commissioning Only.



**Bajaj Energy Ltd, 3X660MW LPGCL, Lalitpur, Uttar Pradesh**

**Station- 765/220kV LPGCL Switchyard**

**Audit Year**

**Document Rev**

Document No- LPGCL-EMD/DP/36

2024

00

**TITLE: Internal Protection Audit of 765kV & 220kV Switchyard**

**B) Sub-station protection and monitoring Equipment**

Sr No.	System	LBB (Make & Model)	Functional (Yes / No)	Date of last testing	Event Logger (Make & Model)	Functional (Yes / No)	Syn. Facility Available or not	Syn. Check Relay (Make and Model)	Setting of Syn. check Relay
i)	GT Bay	Make-Schneider, Model -P141	Yes	Feb-2015	Each protection Relay is having own Event logger as inbuilt function. However common Event logger is having in SAS.	Yes	Yes	Make-Schneider, Model -C264	1.) Voltage Threshold: 10% 2.)Phase Angle Threshold: 20 Degree 3.)Frequency Threshold: 0.45%
II)	ICT Bay	Make-Schneider, Model -P141	Yes	Feb-2015	Each protection Relay is having own Event logger as inbuilt function. However common Event logger is having in SAS.	Yes	Yes	Make-Schneider, Model -C264	1.) Voltage Threshold: 10% 2.)Phase Angle Threshold: 20 Degree 3.)Frequency Threshold: 0.45%
iii)	Bus Reactor Bay	Make-Schneider, Model -P141	Yes	Feb-2015	Each protection Relay is having own Event logger as inbuilt function. However common Event logger is having in SAS.	Yes	Yes	Make-Schneider, Model -C264	1.) Voltage Threshold: 10% 2.)Phase Angle Threshold: 20 Degree 3.)Frequency Threshold: 0.45%





**Bajaj Energy Ltd, 3X660MW LPGCL, Lalitpur, Uttar Pradesh**

**Station- 765/220kV LPGCL Switchyard**

**Audit Year**

**Document Rev**

Document No- LPGCL-EMD/DP/36

2024

00

**TITLE: Internal Protection Audit of 765kV & 220kV Switchyard**

IV)	Line Reactor Bay	Make-Schneider, Model -P643	Yes	Feb-2015	Each protection Relay is having own Event logger as inbuilt function. However common Event logger is having in SAS.	Yes	Yes	Make-Schneider, Model -C264	1.) Voltage Threshold: 10% 2.)Phase Angle Threshold: 20 Degree 3.)Frequency Threshold: 0.45%
V)	765kV Line Bay	Make-Schneider, Model -P141	Yes	Feb-2015	Each protection Relay is having own Event logger as inbuilt function. However common Event logger is having in SAS.	Yes	Yes	Make-Schneider, Model -C264	1.) Voltage Threshold: 10% 2.)Phase Angle Threshold: 20 Degree 3.)Frequency Threshold: 0.45%
VI)	Tie Bay	Make-Schneider, Model -P141	Yes	Feb-2015	Each protection Relay is having own Event logger as inbuilt function. However common Event logger is having in SAS.	Yes	Yes	Make-Schneider, Model -C264	1.) Voltage Threshold: 10% 2.)Phase Angle Threshold: 20 Degree 3.)Frequency Threshold: 0.45%
VII)	220kV all Bay	Make-Schneider, Model -P141	Yes	Jan-2014	Each protection Relay is having own Event logger as inbuilt function. However common Event logger is having in SAS.	Yes	Yes	Make-Schneider, Model -C264	1.) Voltage Threshold: 10% 2.)Phase Angle Threshold: 20 Degree 3.)Frequency Threshold: 0.45%



**Bajaj Energy Ltd, 3X660MW LPGCL, Lalitpur, Uttar Pradesh**

**Station- 765/220kV LPGCL Switchyard**

**Audit Year**

**Document Rev**

Document No- LPGCL-EMD/DP/36

2024

00

**TITLE: Internal Protection Audit of 765kV & 220kV Switchyard**

### C) Transmission Line Protection

Sr No	Name of Line	LBB Protection (Make and Model)	Functional (Yes / No)	Date of testing	PLCC/ Protection coupler/FOTE (Make and Model)	Functional (Yes / No)	DR (Make & Model)	Functional (Yes / No)
i)	Line-1 220kV (Kalyanpura Ckt #01)	Make-Schneider, Model -P141	Yes	Jan-2014	FOTE Make- Commtel with SDH and PDH unit	Yes	Available in respective protection Relay (i.e. ABB-REL670 & Micom-P444)	Yes
ii)	Line-2 220kV (Kalyanpura Ckt #02)	Make-Schneider, Model -P141	Yes	Jan-2014	FOTE Make- Commtel with SDH and PDH unit	Yes	Available in respective protection Relay (i.e. ABB-REL670 & Micom-P444)	Yes
iii)	Line-3 220kV (Dunara Ckt )	Make-Schneider, Model -P141	Yes	Jan-2014	FOTE Make- Commtel with SDH and PDH unit	Yes	Available in respective protection Relay (i.e. ABB-REL670 & Micom-P444)	Yes
iv)	Line-4 220kV (Babina Ckt)	Make-Schneider, Model -P141	Yes	Jan-2014	FOTE Make- Commtel with SDH and PDH unit	Yes	Available in respective protection Relay (i.e. ABB-REL670 & Micom-P444)	Yes
v)	Line-5 765kV (Agra Ckt #01)	Make-Schneider, Model -P141	Yes	Feb-2015	PLCC Make-ABB, Model- ETL-81 & NSD-50	Yes	Available in respective protection Relay (i.e. ABB-REL670 & Micom-P545)	Yes
vi)	Line-6 765kV (Agra Ckt #02)	Make-Schneider, Model -P141	Yes	Feb-2015	PLCC Make-ABB, Model- ETL-81 & NSD-50	Yes	Available in respective protection Relay (i.e. ABB-REL670 & Micom-P545)	Yes



**Bajaj Energy Ltd, 3X660MW LPGCL, Lalitpur, Uttar Pradesh**

**Station- 765/220kV LPGCL Switchyard**

**Audit Year**

**Document Rev**

Document No- LPGCL-EMD/DP/36

2024

00

**TITLE: Internal Protection Audit of 765kV & 220kV Switchyard**

Sr No	Name of Line	Main-I Protection (Make and Model)	Functional (Yes / No)	Date of testing	Main-II Protection (Make and Model)	Functional (Yes / No)	Date of testing
i)	Line-1 220kV (Kalyanpura Ckt #01)	Make- ABB, Model- REL670	Yes	Feb-2014	Make- Schneider, Model - P444	Yes	Feb-2014
ii)	Line-2 220kV (Kalyanpura Ckt #02)	Make- ABB, Model- REL670	Yes	Feb-2014	Make- Schneider, Model - P444	Yes	Feb-2014
iii)	Line-3 220kV (Dunara Ckt )	Make- ABB, Model- REL670	Yes	Feb-2014	Make- Schneider, Model - P444	Yes	Feb-2014
iv)	Line-4 220kV (Babina Ckt)	Make- ABB, Model- REL670	Yes	Feb-2014	Make- Schneider, Model - P444	Yes	Feb-2014
v)	Line-5 765kV (Agra Ckt #01)	Make- ABB, Model- REL670	Yes	May-2016	Make- Schneider, Model - P545	Yes	May-2016
vi)	Line-6 765kV (Agra Ckt #02)	Make- ABB, Model- REL670	Yes	May-2016	Make- Schneider, Model - P545	Yes	May-2016



**Bajaj Energy Ltd, 3X660MW LPGCL, Lalitpur, Uttar Pradesh**

**Station- 765/220kV LPGCL Switchyard**

**Audit Year**

**Document Rev**

Document No- LPGCL-EMD/DP/36

2024

00

**TITLE: Internal Protection Audit of 765kV & 220kV Switchyard**

**D) Transformer Protection**

Sr No	Name of ICT	Diff. Prot. (Make & Model)	REF Pro. (Make & Model)	Back-up OC Prot. (Make & Model)	Over Flux Prot. (Make & Model)	OTI/WTI Indication working or not	Bucholtz / PRD	Other prot.	Date of last testing	LA Rating HV Side	LA Rating IV Side
i)	ICT-1	Make-Schneider, Model-P642	Make-Schneider, Model -P141	Make-Schneider, Model-P642	Make- Schneider, Model-P643	Working	Yes	870H, 870A, SEF & LBB	Feb-2015	624KV	198KV
ii)	ICT-2	Make-Schneider, Model-P642	Make-Schneider, Model -P141	Make-Schneider, Model-P642	Make- Schneider, Model-P643	Working	Yes	870H, 870A, SEF & LBB	Feb-2015	624KV	198KV



**Bajaj Energy Ltd, 3X660MW LPGCL, Lalitpur, Uttar Pradesh**

**Station- 765/220kV LPGCL Switchyard**

**Audit Year**

**Document Rev**

Document No- LPGCL-EMD/DP/36

2024

00

**TITLE: Internal Protection Audit of 765kV & 220kV Switchyard**

### E) Reactor Protection

Sr No	Name of Reactor	Differential Protection (Make & Model)	REF Prot. (Make & Model)	Back-up Impedance Prot. (Make & Model)	OTI/WTI Indication working or not	Bucholtz / PRD	Other Prot.	Date of testing	LA Rating HV Side
i)	765kV Line -1 Reactor	Make- Schneider, Model-P642	Make- Schneider, Model-P642	No	Working	Yes	LBB, OC & EF	Feb-2015	624KV
ii)	765kV Line -2 Reactor	Make- Schneider, Model-P642	Make- Schneider, Model-P642	No	Working	Yes	LBB, OC & EF	Feb-2015	624KV
iii)	765kV Bus Reactor-1	Make- Schneider, Model-P643	Make- Schneider, Model-P643	No	Working	Yes	LBB, OC & EF	Feb-2015	624KV
iv)	765kV Bus Reactor-2	Make- Schneider, Model-P643	Make- Schneider, Model-P643	No	Working	Yes	LBB, OC & EF	Feb-2015	624KV



**Bajaj Energy Ltd, 3X660MW LPGCL, Lalitpur, Uttar Pradesh**

**Station- 765/220kV LPGCL Switchyard**

**Audit Year**

**Document Rev**

Document No- LPGCL-EMD/DP/36

2024

00

**TITLE: Internal Protection Audit of 765kV & 220kV Switchyard**

#### 4) Line Parameter

Sr No		Line 1	Line 2	Line 3	Line 4	Line 5	Line 6
i)	Name of Line	Line-1 220kV (Kalyanpura Ckt #01)	Line-2 220kV (Kalyanpura Ckt #02)	Line-3 220kV (Dunara Ckt #01)	Line-4 220kV (Babina Ckt #01)	Line-5 765kV (Agra Ckt #01)	Line-6 765kV(Agra Ckt #02)
ii)	Line Length	18.52 KM	18.52 KM	92.30 KM	60.33 KM	336.5 KM	335 KM
iii)	Line Parameters ( In Ohms/Per KM/ Per Phase Primary value)						
	R1	0.08	0.08	0.08	0.08	0.0114	0.0114
	X1	0.4002	0.4002	0.4002	0.4002	0.2855	0.2855
	Ro	0.2401	0.2401	0.2401	0.2401	0.1898	0.1898
	Xo	1.201	1.201	1.201	1.201	0.7671	0.7671
	RoM	0.138	0.138	0.138	0.138		
	XoM	0.536	0.536	0.536	0.536		
iv)	Present Relay setting						
a	Adopted Relay setting	Enclosed as Annexure -I ( Please enclose the settings for all lines, transformers, Reactors and Bus Bars)					
b	Recommended Relay setting	Enclosed as Annexure -II ( Please enclose the settings for all lines, transformers, Reactors and Bus Bars)					



**Bajaj Energy Ltd, 3X660MW LPGCL, Lalitpur, Uttar Pradesh**

**Station- 765/220kV LPGCL Switchyard**

**Audit Year**

**Document Rev**

Document No- LPGCL-EMD/DP/36

2024

00

**TITLE: Internal Protection Audit of 765kV & 220kV Switchyard**

5) DC supply

Sr No		220 /110 V DC-I	220 /110 V DC-II	48 V DC-I	48 V DC-II
a	Measured voltage (to be measured at further set Panel				
i)	Positive to Earth	110V DC	110V DC	48V DC	48V DC
ii)	Negative to Earth	110V DC	110V DC	NA	NA
b	No. of Cells Per Bank	107	107	24	24
c	Availability of Battery Charger	Yes/No	Yes/No	Yes/No	Yes/No



**Bajaj Energy Ltd, 3X660MW LPGCL, Lalitpur, Uttar Pradesh**

**Station- 765/220kV LPGCL Switchyard**

**Audit Year**

**Document Rev**

Document No- LPGCL-EMD/DP/36

2024

00

**TITLE: Internal Protection Audit of 765kV & 220kV Switchyard**

## 6) Circuit Breaker

Sr No	Make and Model	Status of Breaker Available or Not	No. of trip/close coil & healthiness	PIR (Available or Not)	Date of Last Timing taken	Remarks (If any)
<b>A)</b>	<b>765 kV System</b>					
1	701 GT#1 Bay	ALSTOM-GL318	Available	Healthy: CC: 6 Nos.&TC: 12 Nos.	NOT	24.11.2023
2	702 Tie Bay	ALSTOM-GL318	Available	Healthy: CC: 6 Nos.&TC: 12 Nos.	NOT	28.11.2023
3	703 ICT#2 Bay	ALSTOM-GL318	Available	Healthy: CC: 6 Nos.&TC: 12 Nos.	NOT	30.11.2023
4	704 BR#1 Bay	ALSTOM-GL318	Available	Healthy: CC: 6 Nos.&TC: 12 Nos.	NOT	05.06.2023
5	705 Tie Bay	ALSTOM-GL318	Available	Healthy: CC: 6 Nos.&TC: 12 Nos.	NOT	09.01.2023
6	706 ICT#1 Bay	ALSTOM-GL318	Available	Healthy: CC: 6 Nos.&TC: 12 Nos.	NOT	10.01.2023
7	707 GT#2 Bay	ALSTOM-GL318	Available	Healthy: CC: 6 Nos.&TC: 12 Nos.	NOT	07.02.2023
8	708 Tie Bay	ALSTOM-GL318	Available	Healthy: CC: 6 Nos.&TC: 12 Nos.	PIR	11.02.2023
9	709 Line#1 Bay	ALSTOM-GL318	Available	Healthy: CC: 6 Nos.&TC: 12 Nos.	PIR	03.03.2021
10	709 LR#1 Bay	ALSTOM-GL318	Available	Healthy: CC: 6 Nos.&TC: 12 Nos.	NOT	06.03.2021
11	710 GT#3 Bay	ALSTOM-GL318	Available	Healthy: CC: 6 Nos.&TC: 12 Nos.	NOT	05.01.2023
12	711 Tie Bay	ALSTOM-GL318	Available	Healthy: CC: 6 Nos.&TC: 12 Nos.	PIR	07.01.2023
13	712 Line #2 Bay	ALSTOM-GL318	Available	Healthy: CC: 6 Nos.&TC: 12 Nos.	PIR	23.01.2021
14	712 LR #2 Bay	ALSTOM-GL318	Available	Healthy: CC: 6 Nos.&TC: 12 Nos.	NOT	16.03.2021
15	713 BR#2 Bay	ALSTOM-GL318	Available	Healthy: CC: 6 Nos.&TC: 12 Nos.	NOT	30.11.2021
16	714 Tie Bay	ALSTOM-GL318	Available	Healthy: CC: 6 Nos.&TC: 12 Nos.	PIR	01.12.2021





**Bajaj Energy Ltd, 3X660MW LPGCL, Lalitpur, Uttar Pradesh**

**Station- 765/220kV LPGCL Switchyard**

**Audit Year**

**Document Rev**

Document No- LPGCL-EMD/DP/36

2024

00

**TITLE: Internal Protection Audit of 765kV & 220kV Switchyard**

B	220kV System						
1	201 ICT#1 Bay	ALSTOM-GL314	Available	Healthy: CC: 3 Nos.&TC: 6 Nos.	NOT	13.01.2023	
2	202 Line#1 Bay	ALSTOM-GL314	Available	Healthy: CC: 3 Nos.&TC: 6 Nos.	NOT	18.04.2024	
3	203 Line#2 Bay	ALSTOM-GL314	Available	Healthy: CC: 3 Nos.&TC: 6 Nos.	NOT	19.04.2024	
4	204 ICT#1 Bay	ALSTOM-GL314	Available	Healthy: CC: 3 Nos.&TC: 6 Nos.	NOT	23.11.2023	
5	205 TBC Bay	ALSTOM-GL314	Available	Healthy: CC: 3 Nos.&TC: 6 Nos.	NOT	28.02.2024	
6	206 BC Bay	ALSTOM-GL314	Available	Healthy: CC: 3 Nos.&TC: 6 Nos.	NOT	16.01.2023	
7	207 Line#3 Bay	ALSTOM-GL314	Available	Healthy: CC: 3 Nos.&TC: 6 Nos.	NOT	22.03.2021	
8	208 Line#4 Bay	ALSTOM-GL314	Available	Healthy: CC: 3 Nos.&TC: 6 Nos.	NOT	11.11.2021	
9	209 ST#2 Bay	ALSTOM-GL314	Available	Healthy: CC: 3 Nos.&TC: 6 Nos.	NOT	09.11.2021	
10	210 ST#1 Bay	ALSTOM-GL314	Available	Healthy: CC: 3 Nos.&TC: 6 Nos.	NOT	19.03.2022	



**Bajaj Energy Ltd, 3X660MW LPGCL, Lalitpur, Uttar Pradesh**

**Station- 765/220kV LPGCL Switchyard**

**Audit Year**

**Document Rev**

Document No- LPGCL-EMD/DP/36

2024

00

**TITLE: Internal Protection Audit of 765kV & 220kV Switchyard**

## 7) Availability of Auxiliary System

i)	Auxiliary Supply	Source of Supply	Reliability of Supply	Average tripping per month
	Supply-I	PMCC (Switchyard)	24X7	0
	Supply-II	NEPMCC (T.G)	24X7	0
ii)	DG Set Make Rating	Caterpillar, 2MVA (Total -04 Nos)		
	Whether Dg set on Auto or manual Fuel level	Auto		

## 8) Availability of UFR relay

Make -

Setting – Not applicable

## 9) Availability of df/dt relay

Make - P141

Setting - Not applicable



<b>Bajaj Energy Ltd, 3X660MW LPGCL, Lalitpur, Uttar Pradesh</b>		
<b>Station- 765/220kV LPGCL Switchyard</b>	<b>Audit Year</b>	<b>Document Rev</b>
Document No- LPGCL-EMD/DP/36	2024	00
<b>TITLE: Internal Protection Audit of 765kV &amp; 220kV Switchyard</b>		

### 10) Special Protection Scheme (SPS)

Available (Yes/No): **Yes**

Verification -Mock testing done jointly with UPPTCL in May 2024.

### 11) Status of Corrective action based On Tripping analysis

It was observed during L-G fault in Z-1 of Dunara-LPGCL Ckt, both Permissive & Direct trip signals were received at LPGCL end and AR got failed on 1ph fault , After detail analysis and site visit at UPPTCL Dunara station, it was found the Zone-1, 1ph tripping connected in DT send logic. Same was also confirmed by simulating the 1Ph fault. The case was discussed with UPPTCL official and BO cable removed temporary until logic correction inside the relay. M/s UPPTCL confirmed to correct the logic with the help of OEM/T&C team and normalised & reconnect the BO cable for operation.

# INTERNAL PROTECTION CHECKLISTS

Sr No	Check Points	Yes	No	Remarks
1	Is breaker fail protection ( LBB / BFR) provided for all the Circuit Breakers at 220kV Voltage rating	<input checked="" type="checkbox"/>	<input type="checkbox"/>	
2	For Circuit Breaker connected to line feeder / transformer feeder, whether operation of LBB / BFR sends direct trip signal to trip remote end breaker ?	<input checked="" type="checkbox"/>	<input type="checkbox"/>	
3	For lines employing single phase auto reclosing, Is start signal from protection trip to LBB / BFR relay is given on single phase basis?	<input checked="" type="checkbox"/>	<input type="checkbox"/>	
4	Is separate relay provided for each breaker and the relay has to be connected from the secondary circuit of the CTs associated with that particular breaker?	<input checked="" type="checkbox"/>	<input type="checkbox"/>	
5	Is LBB relay provided with separate DC circuit independent from Group-A and Group-B Protections?	<input type="checkbox"/>	<input checked="" type="checkbox"/>	
6	Is the LBB initiation provided with initiating contact independent of CB trip relay contact?	<input checked="" type="checkbox"/>	<input type="checkbox"/>	
7	Is Separation maintained between protective relay and CB trip coil DC circuit so that short circuit or blown fuse in the CB circuit will not prevent the protective relay from energizing the LBB scheme?	<input checked="" type="checkbox"/>	<input type="checkbox"/>	
8	Is LBB relay initiated by Bus bar protection in addition to other fault sensing relays, since failure of CB to clear a bus fault would result in the loss of entire station if BFP relay is not initiated?	<input checked="" type="checkbox"/>	<input type="checkbox"/>	
9	Is tripping logic of the bus bar protection scheme used for LBB protection also?	<input checked="" type="checkbox"/>	<input type="checkbox"/>	
10	Are the special considerations provided to ensure proper scheme operation by using Circuit Breaker contact logic in addition to current detectors in cases breaker-fail relaying for low energy faults like buchholz operation?	<input type="checkbox"/>	<input checked="" type="checkbox"/>	Current detector only use for LBB protection in all bays with 20% setting as per CT ratio.
11	Are the Current level detectors set as sensitive as the main protection? (Generally setting of 0.2 A is commonly practiced for lines and transformers)	<input checked="" type="checkbox"/>	<input type="checkbox"/>	
12	Is timer set considering breaker interrupting time, current detector reset time and a margin? (Generally a timer setting of 200ms has been found to be adequate)	<input checked="" type="checkbox"/>	<input type="checkbox"/>	
13	Is the back-up fault clearance time is shorter than the operating time of the remote protections (distance relay Zone-2) ?	<input type="checkbox"/>	<input checked="" type="checkbox"/>	
14	Is the breaker failure protection provided with two steps ( First stage – retrip own CB, Second stage- Trip all associated CBs) . This mitigates unwanted operation of breaker failure protection during maintenance and fault tracing.	<input type="checkbox"/>	<input checked="" type="checkbox"/>	Only 1 stage is provided with 200ms Time delay to operate bus bar and sent DT based on tie CB status.
15	Is the breaker failure protection hardware provided is separate from line /transformer feeder protection?	<input checked="" type="checkbox"/>	<input type="checkbox"/>	

Sr No	Check Points	Yes	No	Remarks
1	Is breaker fail protection ( LBB / BFR) provided for all the Circuit Breakers at 765kV Voltage rating	<input checked="" type="checkbox"/>	<input type="checkbox"/>	
2	For Circuit Breaker connected to line feeder / transformer feeder, whether operation of LBB / BFR sends direct trip signal to trip remote end breaker ?	<input checked="" type="checkbox"/>	<input type="checkbox"/>	
3	For lines employing single phase auto reclosing, Is start signal from protection trip to LBB / BFR relay is given on single phase basis?	<input checked="" type="checkbox"/>	<input type="checkbox"/>	
4	Is separate relay provided for each breaker and the relay has to be connected from the secondary circuit of the CTs associated with that particular breaker?	<input checked="" type="checkbox"/>	<input type="checkbox"/>	Except 765kV Line reactor, LBB protection provided in Separate relays
5	Is LBB relay provided with separate DC circuit independent from Group-A and Group-B Protections?	<input type="checkbox"/>	<input checked="" type="checkbox"/>	
6	Is the LBB initiation provided with initiating contact independent of CB trip relay contact?	<input checked="" type="checkbox"/>	<input type="checkbox"/>	
7	Is Separation maintained between protective relay and CB trip coil DC circuit so that short circuit or blown fuse in the CB circuit will not prevent the protective relay from energizing the LBB scheme?	<input checked="" type="checkbox"/>	<input type="checkbox"/>	
8	Is LBB relay initiated by Bus bar protection in addition to other fault sensing relays, since failure of CB to clear a bus fault would result in the loss of entire station if BFP relay is not initiated?	<input checked="" type="checkbox"/>	<input type="checkbox"/>	
9	Is tripping logic of the bus bar protection scheme used for LBB protection also?	<input checked="" type="checkbox"/>	<input type="checkbox"/>	
10	Are the special considerations provided to ensure proper scheme operation by using Circuit Breaker contact logic in addition to current detectors in cases breaker-fail relaying for low energy faults like buchholz operation?	<input type="checkbox"/>	<input checked="" type="checkbox"/>	Current detector only use for LBB protection in all bays with 20% setting as per CT ratio.
11	Are the Current level detectors set as sensitive as the main protection? (Generally setting of 0.2 A is commonly practiced for lines and transformers)	<input checked="" type="checkbox"/>	<input type="checkbox"/>	
12	Is timer set considering breaker interrupting time, current detector reset time and a margin? (Generally a timer setting of 200ms has been found to be adequate)	<input checked="" type="checkbox"/>	<input type="checkbox"/>	
13	Is the back-up fault clearance time is shorter than the operating time of the remote protections (distance relay Zone-2) ?	<input type="checkbox"/>	<input checked="" type="checkbox"/>	
14	Is the breaker failure protection provided with two steps ( First stage – retrip own CB, Second stage- Trip all associated CBs) . This mitigates unwanted operation of breaker failure protection during maintenance and fault tracing.	<input type="checkbox"/>	<input checked="" type="checkbox"/>	Only 1 stage is provided with 200ms Time delay to operate bus bar and sent DT based on tie CB status.
15	Is the breaker failure protection hardware provided is separate from line /transformer feeder protection?	<input checked="" type="checkbox"/>	<input type="checkbox"/>	In Line reactor LBB function provided in differential protection (P642).

bajaj ENERGY		Communication Systems		Remarks
Sr No	Check Points	Yes	No	
1	a) Do you use PLCC for tele-protection of distance relays at 765 & 220kV feeders	<input checked="" type="checkbox"/>	<input type="checkbox"/>	PLCC is used in 765kV & FOTE is used for 220kV
	b) Specify type of coupling	Ph-G	PH-PH	
	c) Whether redundant PLCC channels provided for 765kV lines	<input checked="" type="checkbox"/>	<input type="checkbox"/>	
	d) Specify number of PLCC channels per circuit :	2		
	e) Whether dependability & security of each tele-protection channel measured & record kept ?	<input checked="" type="checkbox"/>	<input type="checkbox"/>	
2	a) In case you use OPGW for tele-protection, are they on geographically diversified route for Main-I and Main-II relay?	<input type="checkbox"/>	<input checked="" type="checkbox"/>	
	b) Whether dedicated fibre is being used for Main-I / Main-II relay or multiplexed channel are being used.	Dedicated	multiplexed	
3	765kV Ckt #01 PLCC Chanel Used for protection & communication Healthyness Condition			
	Chanel #01 (Healthy)	<input checked="" type="checkbox"/>	<input type="checkbox"/>	
	Chanel #02 (Healthy)	<input checked="" type="checkbox"/>	<input type="checkbox"/>	
4	765kV Ckt #02 PLCC Chanel Used for protection & communication Healthyness Condition			
	Chanel #01 (Healthy)	<input checked="" type="checkbox"/>	<input type="checkbox"/>	
	Chanel #02 (Healthy)	<input checked="" type="checkbox"/>	<input type="checkbox"/>	
6	PLCC Carrier Chanel Healthyness Condition (Healthy)	<input checked="" type="checkbox"/>	<input type="checkbox"/>	
7	PLCC DT Chanel Healthyness Condition (Healthy)	<input checked="" type="checkbox"/>	<input type="checkbox"/>	
8	220kV Kalyanpura Ckt #01 FOTE Chanel Used for protection & communication Healthyness Condition (Healthy)	<input checked="" type="checkbox"/>	<input type="checkbox"/>	
9	220kV Kalyanpura Ckt #02 FOTE Chanel Used for protection & communication Healthyness Condition (Healthy)	<input checked="" type="checkbox"/>	<input type="checkbox"/>	
10	220kV Babina Ckt FOTE Chanel Used for protection & communication Healthyness Condition (Healthy)	<input checked="" type="checkbox"/>	<input type="checkbox"/>	
11	220kV Dunara Ckt FOTE Chanel Used for protection & communication Healthyness Condition (Healthy)	<input checked="" type="checkbox"/>	<input type="checkbox"/>	
12	FOTE Chanel DB Losses within permissible limit	<input checked="" type="checkbox"/>	<input type="checkbox"/>	
13	FOTE Carrier Chanel Healthyness Condition (Healthy)	<input checked="" type="checkbox"/>	<input type="checkbox"/>	
14	FOTE DT Chanel Healthyness Condition (Healthy)	<input checked="" type="checkbox"/>	<input type="checkbox"/>	

Bus Bar 220kV				Remarks
Sr No	Check Points	Yes	No	
1	Bus Bar protection for 220kV buses is provided	<input checked="" type="checkbox"/>	<input type="checkbox"/>	
2	Duplicated Bus bar protection is provided for 220kV buses	<input checked="" type="checkbox"/>	<input type="checkbox"/>	
3	CBIP guideline for Protection (274 and 296) settings is followed	<input checked="" type="checkbox"/>	<input type="checkbox"/>	
4	In an existing substation if CTs are of different ratios, is biased type bus protection provided.	<input checked="" type="checkbox"/>	<input type="checkbox"/>	
5	In stations where single bus bar protection is provided, is backup provided by reverse looking elements of distance relays or by second zone elements of remote end distance relays?			Not Applicable as dual bus bar protection provided for 220kV Bus.
6	In case of GIS where burn through time of SF6 is shorter than remote back up protection is the bus bar protection duplicated irrespective of voltage level?			Not Applicable
7	Since it is difficult to get shutdowns to allow periodic testing of bus protection, numerical bus protections with self-supervision feature is an answer. Is this followed?	<input checked="" type="checkbox"/>	<input type="checkbox"/>	



Sr No	Check Points	Yes	No	Remarks
1	Bus Bar protection for 765kV buses is provided	<input checked="" type="checkbox"/>	<input type="checkbox"/>	
2	Duplicated Bus bar protection is provided for 765kV buses	<input checked="" type="checkbox"/>	<input type="checkbox"/>	
3	CBIP guideline for Protection (274 and 296) settings is followed	<input checked="" type="checkbox"/>	<input type="checkbox"/>	
4	In an existing substation if CTs are of different ratios, is biased type bus protection provided.	<input checked="" type="checkbox"/>	<input type="checkbox"/>	
5	In stations where single bus bar protection is provided, is backup provided by reverse looking elements of distance relays or by second zone elements of remote end distance relays?			Not Applicable as dual bus bar protection provided for 765kV Buses.
6	In case of GIS where burn through time of SF6 is shorter than remote back up protection is the bus bar protection duplicated irrespective of voltage level?			Not Applicable
7	Since it is difficult to get shutdowns to allow periodic testing of bus protection, numerical bus protections with self-supervision feature is an answer. Is this followed?	<input checked="" type="checkbox"/>	<input type="checkbox"/>	

Sr No	Check Points	Yes	No	Remarks
1	a) Is the Disturbance recorder and Fault locator provided on all line feeder of 765 & 220kV substations?	<input checked="" type="checkbox"/>	<input type="checkbox"/>	Standalone DR recorder system provided along with in-built DR captured facility in relay for all 765kV and 220kV Lines.
	b) Whether standalone or built in Main relay	Standalone	built-in	
	c) Whether DR is having automatic fault record download facility to a central PC	<input type="checkbox"/>	<input checked="" type="checkbox"/>	
	d) Whether Central PC for DR , EL are powered by Inverter (fed from station DC)	<input checked="" type="checkbox"/>	<input type="checkbox"/>	
2	<p>Whether DR is having the following main signals for lines:</p> <p>Analogue signals:</p> <ul style="list-style-type: none"> <li>• From CT: IA, IB, IC, IN</li> <li>• From VT: VAN, VBN, VCN</li> <li>• From Aux. VT: V0</li> </ul> <p>Digital Signals</p> <ul style="list-style-type: none"> <li>• Main 1 Carrier receive</li> <li>• Main 1 Trip</li> <li>• Line O/V Stage I / Stage II</li> <li>• Reactor Fault Trip</li> <li>• Stub Protection Operated.</li> <li>• Main II Trip</li> <li>• Main II Carrier Receive</li> <li>• Direct Trip CH I / II</li> <li>• CB I Status (PH-R, Y &amp; B)</li> <li>• CB II Status (PH R, Y &amp; B)</li> <li>• Bus bar trip</li> <li>• Main / Tie CB LBB Operated</li> <li>• Main / Tie Auto-reclose operated.</li> </ul> <p>DR for Transformer / Reactor feeder should contain analog channel like input currents &amp; voltage. Binary signal include all protection trip input, Main &amp; Tie CB status, LBB trip</p>	<input checked="" type="checkbox"/>	<input type="checkbox"/>	
3	Whether substation (765, 220kV) is having Event logger facility (standalone or built-in-SAS)	<input checked="" type="checkbox"/>	<input type="checkbox"/>	Built in SAS
4	Whether GPS based time synchronizing equipment is provided at the substation for time synchronizing of Main relays / DR/ Event logger / SAS/ PMU / Line Current Differential Relays	<input checked="" type="checkbox"/>	<input type="checkbox"/>	

Sr No	Check Points	Yes	No
1	Is there a system of periodically measuring Dependability & Security of Protection system (as given in CBIP manual 296) and recorded	<input checked="" type="checkbox"/>	<input type="checkbox"/>
2	Is there a system of periodically measuring Dependability of switchgear associated with Protection system and recorded	<input checked="" type="checkbox"/>	<input type="checkbox"/>
3	Is there a process of Root cause analysis of unwanted tripping events	<input checked="" type="checkbox"/>	<input type="checkbox"/>
4	Are improvement action like revision of relay setting, better maintenance practices, modernising & retrofitting of switching & protection system taken based on above data.	<input checked="" type="checkbox"/>	<input type="checkbox"/>
5	Is attention also given to DC supply system, tele-protection signalling, healthiness of tripping cables, terminations etc. in order to improve the performance of fault clearance system	<input checked="" type="checkbox"/>	<input type="checkbox"/>

Sr No	Check Points	Yes	No
1	Do you have two separate independent DC system (220V /110V) (Source-A and Source-B)	<input checked="" type="checkbox"/>	<input type="checkbox"/>
2	Do you have two independent DC system (48V) for PLCC (source-A and source-B)	<input checked="" type="checkbox"/>	<input type="checkbox"/>
3	There is no mixing of supplies from DC source-A and DC source-B	<input checked="" type="checkbox"/>	<input type="checkbox"/>
4	Whether the protection relays and trip circuits are segregated into two independent system fed through fuses from two different DC source	<input checked="" type="checkbox"/>	<input type="checkbox"/>
5	Whether Bay wise distribution of DC supply done in the following way: a) Protection b) CB functions c) Isolator / earth switch functions d) Annunciation / Indications e) Monitoring functions	<input checked="" type="checkbox"/>	<input type="checkbox"/>
6	Whether following has been ensured in the cabling: a) Separate cables are used for AC & DC circuits b) Separate cables are used for DC-I & DC-II circuits c) Separate cables are used for different cores of CT and CVT outputs to enhance reliability & security	<input checked="" type="checkbox"/>	<input type="checkbox"/>
7	Is guidelines prescribed in CBIP manual 274 & 296 followed in general	<input checked="" type="checkbox"/>	<input type="checkbox"/>

Sr No	Check Points	Yes	No	Remarks
1	Do you use Group A and Group B protections connected to separate DC sources for reactor	<input checked="" type="checkbox"/>	<input type="checkbox"/>	
2	Do you follow CBIP guideline (274 & 296) for protection setting of reactor	<input checked="" type="checkbox"/>	<input type="checkbox"/>	
3	Do you use duplicated PRD and Bucholtz initiating contact for reactor at 765kV	<input checked="" type="checkbox"/>	<input type="checkbox"/>	
4	Do you classify reactor protections as below in groups: Group A                      Group B • Biased differential relay    Restricted earth fault (REF) relay • PRD , WTI                      Buchholz Protection, OTI • Back up impedance Protection Or Direction O/C & E/F relay	<input checked="" type="checkbox"/>	<input type="checkbox"/>	Impedance relay not provided separately, however backup protection provided
5	In case of Breaker & half switching scheme, whether CT associated with Main & Tie Breakers are connected to separate bias winding of the low impedance Biased differential protection in order to avoid false operation due to dissimilar CT response.	<input checked="" type="checkbox"/>	<input type="checkbox"/>	
6	Is Restricted earth fault (REF) protection used a high impedance type	<input checked="" type="checkbox"/>	<input type="checkbox"/>	
7	Are Main & back-up protection relays provided for Reactor are of numerical design.	<input checked="" type="checkbox"/>	<input type="checkbox"/>	
8	Is Fire protection system (HVW type) provided for Reactor and functioning	<input checked="" type="checkbox"/>	<input type="checkbox"/>	
9	a) Is the Disturbance recorder and Fault locator provided on all the Shunt Reactors used in 765 kV substations?	<input checked="" type="checkbox"/>	<input type="checkbox"/>	
	b) Whether standalone or built in Main relay	Standalone	built-in	
	c) Whether DR is having automatic fault record download facility to a central PC	<input type="checkbox"/>	<input checked="" type="checkbox"/>	

Sr No	Check Points	Yes	No	Remarks
1	Do you use Group A and Group B protections connected to separate DC sources for reactor	<input checked="" type="checkbox"/>	<input type="checkbox"/>	
2	Do you follow CBIP guideline (274 & 296) for protection setting of reactor	<input checked="" type="checkbox"/>	<input type="checkbox"/>	
3	Do you use duplicated PRD and Bucholtz initiating contact for reactor at 765kV	<input checked="" type="checkbox"/>	<input type="checkbox"/>	
4	Do you classify reactor protections as below in groups: Group A                      Group B <ul style="list-style-type: none"> <li>• Biased differential relay      Restricted earth fault (REF) relay</li> <li>• PRD , WTI                      Buchholz Protection, OTI</li> <li>• Back up impedance Protection Or Direction O/C &amp; E/F relay</li> </ul>	<input checked="" type="checkbox"/>	<input type="checkbox"/>	Impedance relay not provided separately, however backup protection provided
5	In case of Breaker & half switching scheme, whether CT associated with Main & Tie Breakers are connected to separate bias winding of the low impedance Biased differential protection in order to avoid false operation due to dissimilar CT response.	<input checked="" type="checkbox"/>	<input type="checkbox"/>	
6	Is Restricted earth fault (REF) protection used a high impedance type	<input checked="" type="checkbox"/>	<input type="checkbox"/>	
7	Are Main & back-up protection relays provided for Reactor are of numerical design.	<input checked="" type="checkbox"/>	<input type="checkbox"/>	
8	Is Fire protection system (HVW type) provided for Reactor and functioning	<input checked="" type="checkbox"/>	<input type="checkbox"/>	
9	a) Is the Disturbance recorder and Fault locator provided on all the Shunt Reactors used in 765 kV substations?	<input checked="" type="checkbox"/>	<input type="checkbox"/>	
	b) Whether standalone or built in Main relay	Standalone	built-in	
	c) Whether DR is having automatic fault record download facility to a central PC	<input type="checkbox"/>	<input checked="" type="checkbox"/>	

Sr No	Check Points	Yes	No	Remarks
1	Do you use Group A and Group B protections connected to separate DC sources for reactor	<input checked="" type="checkbox"/>	<input type="checkbox"/>	
2	Do you follow CBIP guideline (274 & 296) for protection setting of reactor	<input checked="" type="checkbox"/>	<input type="checkbox"/>	
3	Do you use duplicated PRD and Bucholtz initiating contact for reactor at 765kV	<input checked="" type="checkbox"/>	<input type="checkbox"/>	
4	Do you classify reactor protections as below in groups: Group A                      Group B • Biased differential relay    Restricted earth fault (REF) relay • PRD , WTI                      Buchholz Protection, OTI • Back up impedance Protection Or Direction O/C & E/F relay	<input checked="" type="checkbox"/>	<input type="checkbox"/>	Impedance relay not provided separately, however backup protection provided
5	In case of Breaker & half switching scheme, whether CT associated with Main & Tie Breakers are connected to separate bias winding of the low impedance Biased differential protection in order to avoid false operation due to dissimilar CT response.	<input checked="" type="checkbox"/>	<input type="checkbox"/>	
6	Is Restricted earth fault (REF) protection used a high impedance type	<input checked="" type="checkbox"/>	<input type="checkbox"/>	
7	Are Main & back-up protection relays provided for Reactor are of numerical design.	<input checked="" type="checkbox"/>	<input type="checkbox"/>	
8	Is Fire protection system (HVW type) provided for Reactor and functioning	<input checked="" type="checkbox"/>	<input type="checkbox"/>	
9	a) Is the Disturbance recorder and Fault locator provided on all the Shunt Reactors used in 765 kV substations?	<input checked="" type="checkbox"/>	<input type="checkbox"/>	
	b) Whether standalone or built in Main relay	Standalone	built-in	
	c) Whether DR is having automatic fault record download facility to a central PC	<input type="checkbox"/>	<input checked="" type="checkbox"/>	

Sr No	Check Points	Yes	No	Remarks
1	Do you use Group A and Group B protections connected to separate DC sources for reactor	<input checked="" type="checkbox"/>	<input type="checkbox"/>	
2	Do you follow CBIP guideline (274 & 296) for protection setting of reactor	<input checked="" type="checkbox"/>	<input type="checkbox"/>	
3	Do you use duplicated PRD and Bucholtz initiating contact for reactor at 765kV	<input checked="" type="checkbox"/>	<input type="checkbox"/>	
4	Do you classify reactor protections as below in groups: Group A                      Group B • Biased differential relay      Restricted earth fault (REF) relay • PRD , WTI                      Buchholz Protection, OTI • Back up impedance Protection Or Direction O/C & E/F relay	<input checked="" type="checkbox"/>	<input type="checkbox"/>	Impedance relay not provided separately, however backup protection provided
5	In case of Breaker & half switching scheme, whether CT associated with Main & Tie Breakers are connected to separate bias winding of the low impedance Biased differential protection in order to avoid false operation due to dissimilar CT response.	<input checked="" type="checkbox"/>	<input type="checkbox"/>	
6	Is Restricted earth fault (REF) protection used a high impedance type	<input checked="" type="checkbox"/>	<input type="checkbox"/>	
7	Are Main & back-up protection relays provided for Reactor are of numerical design.	<input checked="" type="checkbox"/>	<input type="checkbox"/>	
8	Is Fire protection system (HVW type) provided for Reactor and functioning	<input checked="" type="checkbox"/>	<input type="checkbox"/>	
9	a) Is the Disturbance recorder and Fault locator provided on all the Shunt Reactors used in 765 kV substations?	<input checked="" type="checkbox"/>	<input type="checkbox"/>	
	b) Whether standalone or built in Main relay	Standalone	built-in	
	c) Whether DR is having automatic fault record download facility to a central PC	<input type="checkbox"/>	<input checked="" type="checkbox"/>	



bajaj ENERGY	Power Transformer-765kV/220kV (3X105MVA)ICT Bank # 01			Remarks
Sr No	Check Points	Yes	No	
1	Do you use Group A and Group B protections connected to separate DC sources for power transformers	<input checked="" type="checkbox"/>	<input type="checkbox"/>	
2	Do you follow CBIP guideline (274 & 296) for protection setting of transformer	<input checked="" type="checkbox"/>	<input type="checkbox"/>	
3	Do you use duplicated PRD and Bucholtz initiating contact for power transformers at 765kV and 400kV levels	<input checked="" type="checkbox"/>	<input type="checkbox"/>	
4	Do you classify transformer protections as below in groups: Group A • Biased differential relay • PRD , WTI • Back up Protection(HV) • Overfluxing protection(HV) Group B Restricted earth fault (REF) relay Buchholz Protection, OTI Back up Protection(MV) Overfluxing protection(MV)	<input checked="" type="checkbox"/>	<input type="checkbox"/>	
5	In case of Breaker & half switching scheme, whether CT associated with Main & Tie Breakers are connected to separate bias winding of the low impedance Biased differential protection in order to avoid false operation due to dissimilar CT response.	<input checked="" type="checkbox"/>	<input type="checkbox"/>	
6	Is Restricted earth fault (REF) protection used a high impedance type	<input checked="" type="checkbox"/>	<input type="checkbox"/>	
7	Are Main protection relays provided for transformer are of numerical design.	<input checked="" type="checkbox"/>	<input type="checkbox"/>	
8	a) Are directional over current & earth fault relays provided as back-up protection of Transformer are of numerical design.	<input checked="" type="checkbox"/>	<input type="checkbox"/>	Harmonic restrain for OC & EF setting not available in P642/643, However it is possible to block its trip timer through PSL logic.
	b) Do the back-up earth fault relays have harmonic restrain feature	<input type="checkbox"/>	<input checked="" type="checkbox"/>	
9	Is Fire protection system (HVW type) provided for power transformer and functioning	<input checked="" type="checkbox"/>	<input type="checkbox"/>	
10	a) Is the Disturbance recorder provided for Transformer feeder	<input checked="" type="checkbox"/>	<input type="checkbox"/>	
	b) Whether standalone or built in Main relay	Standalone	built-in	
	c) Whether DR is having automatic fault record download facility to a central PC	<input type="checkbox"/>	<input checked="" type="checkbox"/>	
	d) Whether DR is time synchronised with the GPS time synchronising equipment	<input checked="" type="checkbox"/>	<input type="checkbox"/>	

bajaj ENERGY		Power Transformer-765kV/220kV (3X105MVA)ICT Bank # 02		Remarks
Sr No	Check Points	Yes	No	
1	Do you use Group A and Group B protections connected to separate DC sources for power transformers	<input checked="" type="checkbox"/>	<input type="checkbox"/>	
2	Do you follow CBIP guideline (274 & 296) for protection setting of transformer	<input checked="" type="checkbox"/>	<input type="checkbox"/>	
3	Do you use duplicated PRD and Bucholtz initiating contact for power transformers at 765kV and 400kV levels	<input checked="" type="checkbox"/>	<input type="checkbox"/>	
4	Do you classify transformer protections as below in groups: Group A • Biased differential relay • PRD , WTI • Back up Protection(HV) • Overfluxing protection(HV) Group B Restricted earth fault (REF) relay Buchholz Protection, OTI Back up Protection(MV) Overfluxing protection(MV)	<input checked="" type="checkbox"/>	<input type="checkbox"/>	
5	In case of Breaker & half switching scheme, whether CT associated with Main & Tie Breakers are connected to separate bias winding of the low impedance Biased differential protection in order to avoid false operation due to dissimilar CT response.	<input checked="" type="checkbox"/>	<input type="checkbox"/>	
6	Is Restricted earth fault (REF) protection used a high impedance type	<input checked="" type="checkbox"/>	<input type="checkbox"/>	
7	Are Main protection relays provided for transformer are of numerical design.	<input checked="" type="checkbox"/>	<input type="checkbox"/>	
8	a) Are directional over current & earth fault relays provided as back-up protection of Transformer are of numerical design.	<input checked="" type="checkbox"/>	<input type="checkbox"/>	Harmonic restrain for OC & EF setting not available in P642/643, However it is possible to block its trip timer through PSL logic.
	b) Do the back-up earth fault relays have harmonic restrain feature	<input type="checkbox"/>	<input checked="" type="checkbox"/>	
9	Is Fire protection system (HWW type) provided for power transformer and functioning	<input checked="" type="checkbox"/>	<input type="checkbox"/>	
10	a) Is the Disturbance recorder provided for Transformer feeder	<input checked="" type="checkbox"/>	<input type="checkbox"/>	
	b) Whether standalone or built in Main relay	Standalone	built-in	
	c) Whether DR is having automatic fault record download facility to a central PC	<input type="checkbox"/>	<input checked="" type="checkbox"/>	
	d) Whether DR is time synchronised with the GPS time synchronising equipment	<input checked="" type="checkbox"/>	<input type="checkbox"/>	

Sr No	Check Points	Yes	No	
1	Do you use Group A and Group B protections connected to separate DC sources for power transformers	<input checked="" type="checkbox"/>	<input type="checkbox"/>	
2	Do you follow CBIP guideline (274 & 296) for protection setting of transformer	<input checked="" type="checkbox"/>	<input type="checkbox"/>	
3	Do you use duplicated PRD and Buchholz initiating contact for power transformers at 765kV levels	<input checked="" type="checkbox"/>	<input type="checkbox"/>	
4	Do you classify transformer protections as below in groups: Group A                      Group B • Biased differential relay      Restricted earth fault (REF) relay • PRD , WTI                      Buchholz Protection, OTI • Back up Protection(HV)      Back up Protection(MV) • Overfluxing protection(HV)      Overfluxing protection(MV)	<input checked="" type="checkbox"/>	<input type="checkbox"/>	
5	In case of Breaker & half switching scheme, whether CT associated with Main & Tie Breakers are connected to separate bias winding of the low impedance Biased differential protection in order to avoid false operation due to dissimilar CT response.	<input checked="" type="checkbox"/>	<input type="checkbox"/>	Only OH differential protection is used in Switchyard balance Protection is used in GRP Relay.
6	Is Restricted earth fault (REF) protection used a high impedance type	<input checked="" type="checkbox"/>	<input type="checkbox"/>	
7	Are Main protection relays provided for transformer are of numerical design.	<input checked="" type="checkbox"/>	<input type="checkbox"/>	
8	a) Are directional over current & earth fault relays provided as back-up protection of Transformer are of numerical design.	<input checked="" type="checkbox"/>	<input type="checkbox"/>	Backup Protection is available in GRP Panel Relay.
	b) Do the back-up earth fault relays have harmonic restrain feature	<input type="checkbox"/>	<input checked="" type="checkbox"/>	
9	Is Fire protection system (HVW type) provided for power transformer and functioning	<input checked="" type="checkbox"/>	<input type="checkbox"/>	
10	a) Is the Disturbance recorder provided for Transformer feeder	<input checked="" type="checkbox"/>	<input type="checkbox"/>	
	b) Whether standalone or built in Main relay	Standalone	built-in	
	c) Whether DR is having automatic fault record download facility to a central PC	<input type="checkbox"/>	<input checked="" type="checkbox"/>	
	d) Whether DR is time synchronised with the GPS time synchronising equipment	<input checked="" type="checkbox"/>	<input type="checkbox"/>	

Sr No	Check Points	Yes	No	Remarks
1	Do you use Group A and Group B protections connected to separate DC sources for power transformers	<input checked="" type="checkbox"/>	<input type="checkbox"/>	
2	Do you follow CBIP guideline (274 & 296) for protection setting of transformer	<input checked="" type="checkbox"/>	<input type="checkbox"/>	
3	Do you use duplicated PRD and Buchholz initiating contact for power transformers at 765kV levels	<input checked="" type="checkbox"/>	<input type="checkbox"/>	
4	Do you classify transformer protections as below in groups: Group A                      Group B • Biased differential relay      Restricted earth fault (REF) relay • PRD , WTI                      Buchholz Protection, OTI • Back up Protection(HV)      Back up Protection(MV) • Overfluxing protection(HV)      Overfluxing protection(MV)	<input checked="" type="checkbox"/>	<input type="checkbox"/>	
5	In case of Breaker & half switching scheme, whether CT associated with Main & Tie Breakers are connected to separate bias winding of the low impedance Biased differential protection in order to avoid false operation due to dissimilar CT response.	<input checked="" type="checkbox"/>	<input type="checkbox"/>	Only OH differential protection is used in Switchyard balance Protection is used in GRP Relay.
6	Is Restricted earth fault (REF) protection used a high impedance type	<input checked="" type="checkbox"/>	<input type="checkbox"/>	
7	Are Main protection relays provided for transformer are of numerical design.	<input checked="" type="checkbox"/>	<input type="checkbox"/>	
8	a) Are directional over current & earth fault relays provided as back-up protection of Transformer are of numerical design.	<input checked="" type="checkbox"/>	<input type="checkbox"/>	Backup Protection is available in GRP Panel Relay.
	b) Do the back-up earth fault relays have harmonic restrain feature	<input type="checkbox"/>	<input checked="" type="checkbox"/>	
9	Is Fire protection system (HVW type) provided for power transformer and functioning	<input checked="" type="checkbox"/>	<input type="checkbox"/>	
10	a) Is the Disturbance recorder provided for Transformer feeder	<input checked="" type="checkbox"/>	<input type="checkbox"/>	
	b) Whether standalone or built in Main relay	Standalone	built-in	
	c) Whether DR is having automatic fault record download facility to a central PC	<input type="checkbox"/>	<input checked="" type="checkbox"/>	
	d) Whether DR is time synchronised with the GPS time synchronising equipment	<input checked="" type="checkbox"/>	<input type="checkbox"/>	

Sr No	Check Points	Yes	No	Remarks
1	Do you use Group A and Group B protections connected to separate DC sources for power transformers	<input checked="" type="checkbox"/>	<input type="checkbox"/>	
2	Do you follow CBIP guideline (274 & 296) for protection setting of transformer	<input checked="" type="checkbox"/>	<input type="checkbox"/>	
3	Do you use duplicated PRD and Buchholz initiating contact for power transformers at 765kV levels	<input checked="" type="checkbox"/>	<input type="checkbox"/>	
4	Do you classify transformer protections as below in groups: Group A                      Group B • Biased differential relay      Restricted earth fault (REF) relay • PRD , WTI                      Buchholz Protection, OTI • Back up Protection(HV)      Back up Protection(MV) • Overfluxing protection(HV)      Overfluxing protection(MV)	<input checked="" type="checkbox"/>	<input type="checkbox"/>	
5	In case of Breaker & half switching scheme, whether CT associated with Main & Tie Breakers are connected to separate bias winding of the low impedance Biased differential protection in order to avoid false operation due to dissimilar CT response.	<input checked="" type="checkbox"/>	<input type="checkbox"/>	Only OH differential protection is used in Switchyard balance Protection is used in GRP Relay.
6	Is Restricted earth fault (REF) protection used a high impedance type	<input checked="" type="checkbox"/>	<input type="checkbox"/>	
7	Are Main protection relays provided for transformer are of numerical design.	<input checked="" type="checkbox"/>	<input type="checkbox"/>	
8	a) Are directional over current & earth fault relays provided as back-up protection of Transformer are of numerical design.	<input checked="" type="checkbox"/>	<input type="checkbox"/>	Backup Protection is available in GRP Panel Relay.
	b) Do the back-up earth fault relays have harmonic restrain feature	<input type="checkbox"/>	<input checked="" type="checkbox"/>	
9	Is Fire protection system (HVW type) provided for power transformer and functioning	<input checked="" type="checkbox"/>	<input type="checkbox"/>	
10	a) Is the Disturbance recorder provided for Transformer feeder	<input checked="" type="checkbox"/>	<input type="checkbox"/>	
	b) Whether standalone or built in Main relay	Standalone	built-in	
	c) Whether DR is having automatic fault record download facility to a central PC	<input type="checkbox"/>	<input checked="" type="checkbox"/>	
	d) Whether DR is time synchronised with the GPS time synchronising equipment	<input checked="" type="checkbox"/>	<input type="checkbox"/>	

Sr No	Check Points	Yes	No	Remarks
1	Do you use Group A and Group B protections connected to separate DC sources for power transformers	<input checked="" type="checkbox"/>	<input type="checkbox"/>	
2	Do you follow CBIP guideline (274 & 296) for protection setting of transformer	<input checked="" type="checkbox"/>	<input type="checkbox"/>	
3	Do you use duplicated PRD and Bucholtz initiating contact for power transformers at 220kV levels	<input type="checkbox"/>	<input type="checkbox"/>	Not Applicable
4	Do you classify transformer protections as below in groups: Group A                      Group B • Biased differential relay      Restricted earth fault (REF) relay • PRD , WTI                      Buchholz Protection, OTI • Back up Protection(HV)      Back up Protection(MV) • Overfluxing protection(HV)      Overfluxing protection(MV)	<input checked="" type="checkbox"/>	<input type="checkbox"/>	
5	In case of Breaker & half switching scheme, whether CT associated with Main & Tie Breakers are connected to separate bias winding of the low impedance Biased differential protection in order to avoid false operation due to dissimilar CT response.	<input checked="" type="checkbox"/>	<input type="checkbox"/>	Only OH differential protection is used in Switchyard balance Protection is used in GRP Relay.
6	Is Restricted earth fault (REF) protection used a high impedance type	<input checked="" type="checkbox"/>	<input type="checkbox"/>	
7	Are Main protection relays provided for transformer are of numerical design.	<input checked="" type="checkbox"/>	<input type="checkbox"/>	
8	a) Are directional over current & earth fault relays provided as back-up protection of Transformer are of numerical design.	<input checked="" type="checkbox"/>	<input type="checkbox"/>	Backup Protection is available in GRP Panel Relay.
	b) Do the back-up earth fault relays have harmonic restrain feature	<input type="checkbox"/>	<input checked="" type="checkbox"/>	
9	Is Fire protection system (HVW type) provided for power transformer and functioning	<input checked="" type="checkbox"/>	<input type="checkbox"/>	
10	a) Is the Disturbance recorder provided for Transformer feeder	<input checked="" type="checkbox"/>	<input type="checkbox"/>	
	b) Whether standalone or built in Main relay	Standalone	built-in	
	c) Whether DR is having automatic fault record download facility to a central PC	<input type="checkbox"/>	<input checked="" type="checkbox"/>	
	d) Whether DR is time synchronised with the GPS time synchronising equipment	<input checked="" type="checkbox"/>	<input type="checkbox"/>	

Sr No	Check Points	Yes	No	Remarks
1	Do you use Group A and Group B protections connected to separate DC sources for power transformers	<input checked="" type="checkbox"/>	<input type="checkbox"/>	
2	Do you follow CBIP guideline (274 & 296) for protection setting of transformer	<input checked="" type="checkbox"/>	<input type="checkbox"/>	
3	Do you use duplicated PRD and Buchholz initiating contact for power transformers at 220kV levels	<input type="checkbox"/>	<input type="checkbox"/>	Not Applicable
4	Do you classify transformer protections as below in groups: Group A                      Group B • Biased differential relay      Restricted earth fault (REF) relay • PRD , WTI                      Buchholz Protection, OTI • Back up Protection(HV)      Back up Protection(MV) • Overfluxing protection(HV)      Overfluxing protection(MV)	<input checked="" type="checkbox"/>	<input type="checkbox"/>	
5	In case of Breaker & half switching scheme, whether CT associated with Main & Tie Breakers are connected to separate bias winding of the low impedance Biased differential protection in order to avoid false operation due to dissimilar CT response.	<input checked="" type="checkbox"/>	<input type="checkbox"/>	Only OH differential protection is used in Switchyard balance Protection is used in GRP Relay.
6	Is Restricted earth fault (REF) protection used a high impedance type	<input checked="" type="checkbox"/>	<input type="checkbox"/>	
7	Are Main protection relays provided for transformer are of numerical design.	<input checked="" type="checkbox"/>	<input type="checkbox"/>	
8	a) Are directional over current & earth fault relays provided as back-up protection of Transformer are of numerical design.	<input checked="" type="checkbox"/>	<input type="checkbox"/>	Backup Protection is available in GRP Panel Relay.
	b) Do the back-up earth fault relays have harmonic restrain feature	<input type="checkbox"/>	<input checked="" type="checkbox"/>	
9	Is Fire protection system (HVW type) provided for power transformer and functioning	<input checked="" type="checkbox"/>	<input type="checkbox"/>	
10	a) Is the Disturbance recorder provided for Transformer feeder	<input checked="" type="checkbox"/>	<input type="checkbox"/>	
	b) Whether standalone or built in Main relay	Standalone	built-in	
	c) Whether DR is having automatic fault record download facility to a central PC	<input type="checkbox"/>	<input checked="" type="checkbox"/>	
	d) Whether DR is time synchronised with the GPS time synchronising equipment	<input checked="" type="checkbox"/>	<input type="checkbox"/>	

Sr No	Check Points	Yes	No	Remarks
1	Independent Main-I and Main-II protection (of different make OR different type) is provided with carrier aided scheme	<input checked="" type="checkbox"/>	<input type="checkbox"/>	
2	Are the Main-I & Main-II relays connected to two separate DC sources (Group-A and Group-B)	<input checked="" type="checkbox"/>	<input type="checkbox"/>	
3	Is the Distance protection (Non-switched type, suitable for 1-ph & 3-ph tripping) as Main1 and Main2 provided to ensure selectivity & reliability for all faults in the shortest possible time	<input checked="" type="checkbox"/>	<input type="checkbox"/>	
4	Is both main-I & Main-II distance relay are numerical design having Quadrilateral or Polygon operating characteristic	<input checked="" type="checkbox"/>	<input type="checkbox"/>	
5	In the Main-I / Main-II Distance protection, Zone-I is set cover 80% of the protected line section	<input checked="" type="checkbox"/>	<input type="checkbox"/>	Z-1 cover 80%
6	In the Main-I / Main-II distance protection, Zone-2 is set cover 120% of the protected line section in case of Single circuit line and 150% in case of Double circuit line	<input checked="" type="checkbox"/>	<input type="checkbox"/>	Z-2 cover 150%
7	In the Main-I / Main-II distance protection, Zone-3 is set cover 120% of the total of protected line section plus longest line at remote end as a minimum.	<input checked="" type="checkbox"/>	<input type="checkbox"/>	Z-3 cover-120% (PL+ Longest line at remote)
8	Resistive reach for Ground fault element set to give maximum coverage considering fault resistance, arc resistance & tower footing resistance. (In case, it is not possible to set the ground fault and phase fault reaches separately, load point encroachment condition imposed on Phase fault resistive reach shall be applied)	<input checked="" type="checkbox"/>	<input type="checkbox"/>	
9	Resistive reach for Phase fault element set to give maximum coverage subject to check of possibility against load point encroachment considering minimum expected voltage and maximum load.	<input checked="" type="checkbox"/>	<input type="checkbox"/>	
10	In case of short lines, is manufacturers recommendation considered in respect of resistive setting vis a vis reactance setting to avoid overreach.	<input type="checkbox"/>	<input type="checkbox"/>	Not applicable
11	Is Zone-2 time delay of Main-I / Main-II distance relay set to 0.350 seconds ? In case any other value has been set for Zone-II timer, kindly specify the value and justification thereof.	<input checked="" type="checkbox"/>	<input type="checkbox"/>	500 ms
12	Is Zone-3 timer is set to provide discrimination with the operating time of relays at adjacent sections with which Zone-3 reach of relay is set to overlap. Please specify the Zone-3 time set.	<input checked="" type="checkbox"/>	<input type="checkbox"/>	1500 ms
13	Is Zone-4 reach set in reverse direction to cover expected levels of apparent bus bar fault resistance, when allowing for multiple in feeds from other circuits?	<input checked="" type="checkbox"/>	<input type="checkbox"/>	
14	Is reverse looking Zone-4 time delay set as Zone-2 time delay?	<input checked="" type="checkbox"/>	<input type="checkbox"/>	
15	Is Switch on to fault (SOTF) function provided in distance relay to take care of line energisation on fault? Whether SOTF initiation has been implemented using hardwire logic half switching scheme, whether initiation of line SOTF from CB closing has been interlocked with the other CB	<input checked="" type="checkbox"/>	<input type="checkbox"/>	In case of Breaker and
16	Whether VT fuse fail detection function has been correctly set to block the distance function operation on VT fuse failure	<input checked="" type="checkbox"/>	<input type="checkbox"/>	
17	Is the sensitive IDMT directional E/F relay (either separate relay or built-in function of Main relay) for protection against high resistive earth faults?	<input checked="" type="checkbox"/>	<input type="checkbox"/>	Built in Main-1 & 2
18	Is additional element (Back-up distance) for remote back-up protection function provided in case of unit protection is used as Main relay for lines?	<input type="checkbox"/>	<input type="checkbox"/>	Not Applicable
19	In case of Cables, is unit protection provided as Main-I & Main-II protection with distance as back-up.	<input type="checkbox"/>	<input type="checkbox"/>	Not Applicable
20	Are the line parameters used for setting the relay verified by field testing	<input checked="" type="checkbox"/>	<input type="checkbox"/>	
21	Is Two stages Over-Voltage protection provided for 220 kV Lines? Do you apply grading in over-voltage setting for lines at one station. Please specify the setting values adopted for: Stage-I: (typical value - 106 to 112 %, delay : 4-7 Sec) Stage-II: (typical value - 140 to 150%, delay: 0 to 100msec.)	<input checked="" type="checkbox"/>	<input type="checkbox"/>	U>1 110% @ 3.0Sec U>2 140% @ 0.1Sec
22	Is 1-ph Auto -reclosing provided on 765, 400 & 220kV lines? Please specify the set value: Dead time: (typical 1 Sec) Reclaim time: (typical 25 Sec)	<input checked="" type="checkbox"/>	<input type="checkbox"/>	Dead Time 850 ms
23	Is the Distance communication. Scheme Permissive Over Reach (POR) applied for short lines and Permissive Under Reach (PUR) applied for long lines? If any other communication scheme has been applied, please provide the detail with justification thereof.	<input checked="" type="checkbox"/>	<input type="checkbox"/>	
24	Is the Current reversal guard logic for POR scheme provided on Double circuit lines?	<input type="checkbox"/>	<input checked="" type="checkbox"/>	
25	In case the protected line is getting terminated at a station having very low fault level i.e. HVDC terminal, whether week end-infeed feature has been enabled in respective distance relay or not	<input type="checkbox"/>	<input type="checkbox"/>	Not applicable
26	In case of protected line is originating from nuclear power station, are the special requirement (stability of nuclear plant auxiliaries) as required by them has been met	<input type="checkbox"/>	<input type="checkbox"/>	Not applicable
27	What line current, Voltage and Load angle have been considered for Load encroachment blinder setting and what is the resultant MVA that the line can carry without load encroachment. (In the absence of Load encroachment blinder function, this limit shall be applied to Zone-3 phase fault resistive reach.)			Not Active
28	a) What are the Zones blocked on Power swing block function: b) Setting for Unblock timer: (typical 02 second) c) Out of Step trip enabled	Z1 02 Sec <input type="checkbox"/>	Z2 / Z3 / Z4 <input checked="" type="checkbox"/>	Trip provided in Zone-1, All higher zones are blocked.
29	Whether the location of Out of step relay has been identified on the basis of power system simulation studies	<input type="checkbox"/>	<input checked="" type="checkbox"/>	
30	a) Is the Disturbance recorder provided for Transformer feeder b) Whether standalone or built in Main relay c) Whether DR is having automatic fault record download facility to a central PC d) Whether DR is time synchronised with the GPS time synchronising equipment e) Whether DR analog channels contain line phase & neutral current and line phase & neutral voltage. f) Whether DR digital channel as a minimum contain the CB status, Main-I & II trip status, LBB trip status, Over-voltage trip status, Stub protn trip status, Permissive and direct carrier receive status, Line reactor trip status.	<input checked="" type="checkbox"/> Standalone <input type="checkbox"/> <input checked="" type="checkbox"/> <input checked="" type="checkbox"/> <input checked="" type="checkbox"/>	<input type="checkbox"/> built-in <input type="checkbox"/> <input type="checkbox"/> <input type="checkbox"/>	



Sr No	Check Points	Yes	No	Remarks
1	Independent Main-I and Main-II protection (of different make OR different type) is provided with carrier aided scheme	<input checked="" type="checkbox"/>	<input type="checkbox"/>	
2	Are the Main-I & Main-II relays connected to two separate DC sources (Group-A and Group-B)	<input checked="" type="checkbox"/>	<input type="checkbox"/>	
3	Is the Distance protection (Non-switched type, suitable for 1-ph & 3-ph tripping) as Main1 and Main2 provided to ensure selectivity & reliability for all faults in the shortest possible time	<input checked="" type="checkbox"/>	<input type="checkbox"/>	
4	Is both main-I & Main-II distance relay are numerical design having Quadrilateral or Polygon operating characteristic	<input checked="" type="checkbox"/>	<input type="checkbox"/>	
5	In the Main-I / Main-II Distance protection, Zone-I is set cover 80% of the protected line section	<input checked="" type="checkbox"/>	<input type="checkbox"/>	Z-1 cover 80%
6	In the Main-I / Main-II distance protection, Zone-2 is set cover 120% of the protected line section in case of Single circuit line and 150% in case of Double circuit line	<input checked="" type="checkbox"/>	<input type="checkbox"/>	Z-2 cover 150%
7	In the Main-I / Main-II distance protection, Zone-3 is set cover 120% of the total of protected line section plus longest line at remote end as a minimum.	<input checked="" type="checkbox"/>	<input type="checkbox"/>	Z-3 cover-120%(PL + Longest line at remote)
8	Resistive reach for Ground fault element set to give maximum coverage considering fault resistance, arc resistance & tower footing resistance. ( In case, It is not possible to set the ground fault and phase fault reaches separately, load point encroachment condition imposed on Phase fault resistive reach shall be applied)	<input checked="" type="checkbox"/>	<input type="checkbox"/>	
9	Resistive reach for Phase fault element set to give maximum coverage subject to check of possibility against load point encroachment considering minimum expected voltage and maximum load.	<input checked="" type="checkbox"/>	<input type="checkbox"/>	
10	In case of short lines, is manufacturers recommendation considered in respect of resistive setting vis a vis reactance setting to avoid overreach.	<input type="checkbox"/>	<input type="checkbox"/>	Not applicable
11	Is Zone-2 time delay of Main-I / Main-II distance relay set to 0.350 seconds ? In case any other value has been set for Zone-II timer, kindly specify the value and justification thereof.	<input checked="" type="checkbox"/>	<input type="checkbox"/>	500 ms
12	Is Zone-3 timer is set to provide discrimination with the operating time of relays at adjacent sections with which Zone-3 reach of relay is set to overlap. Please specify the Zone-3 time set.	<input checked="" type="checkbox"/>	<input type="checkbox"/>	1500 ms
13	Is Zone-4 reach set in reverse direction to cover expected levels of apparent bus bar fault resistance, when allowing for multiple in feeds from other circuits?	<input checked="" type="checkbox"/>	<input type="checkbox"/>	
14	Is reverse looking Zone-4 time delay set as Zone-2 time delay?	<input checked="" type="checkbox"/>	<input type="checkbox"/>	
15	Is Switch on to fault (SOTF) function provided in distance relay to take care of line energisation on fault? Whether SOTF initiation has been implemented using hardwire logic in case of Breaker and half switching scheme, whether initiation of line SOTF from CB closing has been interlocked with the other CB	<input checked="" type="checkbox"/>	<input type="checkbox"/>	
16	Whether VT fuse fail detection function has been correctly set to block the distance function operation on VT fuse failure	<input checked="" type="checkbox"/>	<input type="checkbox"/>	
17	Is the sensitive IDMT directional E/F relay (either separate relay or built-in function of Main relay) for protection against high resistive earth faults?	<input checked="" type="checkbox"/>	<input type="checkbox"/>	Built in Main-1 &2
18	Is additional element (Back-up distance) for remote back-up protection function provided in case of unit protection is used as Main relay for lines?	<input type="checkbox"/>	<input type="checkbox"/>	Not Applicable
19	In case of Cables, is unit protection provided as Main-I & Main-II protection with distance as back-up.	<input type="checkbox"/>	<input type="checkbox"/>	Not Applicable
20	Are the line parameters used for setting the relay verified by field testing	<input checked="" type="checkbox"/>	<input type="checkbox"/>	
21	Is Two stages Over-Voltage protection provided for 220 kV Lines? Do you apply grading in over-voltage setting for lines at one station. Please specify the setting values adopted for: Stage-I : (typical value - 106 to 112 % , delay : 4-7 Sec) Stage-II: (typical value - 140 to 150%, delay: 0 to 100msec.)	<input checked="" type="checkbox"/>	<input type="checkbox"/>	U>1 110% @ 3.0Sec U>2 140% @ 0.1Sec
22	Is 1-ph Auto-reclosing provided on 765, 400 & 220kV lines? Please specify the set value: Dead time: (typical 1 Sec) Reclaim time: (typical 25 Sec)	<input checked="" type="checkbox"/>	<input type="checkbox"/>	Dead Time 850 ms
23	Is the Distance communication. Scheme Permissive Over Reach (POR) applied for short lines and Permissive Under Reach (PUR) applied for long lines? If any other communication scheme has been applied, please provide the detail with justification thereof.	<input checked="" type="checkbox"/>	<input type="checkbox"/>	
24	Is the Current reversal guard logic for POR scheme provided on Double circuit lines?	<input type="checkbox"/>	<input checked="" type="checkbox"/>	
25	In case the protected line is getting terminated at a station having very low fault level i.e. HVDC terminal, whether week end-infeed feature has been enabled in respective distance relay or not	<input type="checkbox"/>	<input type="checkbox"/>	Not applicable
26	In case of protected line is originating from nuclear power station, are the special requirement (stability of nuclear plant auxiliaries) as required by them has been met	<input type="checkbox"/>	<input type="checkbox"/>	Not applicable
27	What line current , Voltage and Load angle have been considered for Load encroachment blinder setting and what is the resultant MVA that the line can carry without load encroachment. (In the absence of Load encroachment blinder function, this limit shall be applied to Zone-3 phase fault resistive reach.)			Not Active
28	a) What are the Zones blocked on Power swing block function: b) Setting for Unblock timer: (typical 02 second) c) Out of Step trip enabled	Z1 02 Sec	Z2 / Z3 / Z4	Trip provided in Zone-1, All higher zones are blocked.
29	Whether the location of Out of step relay has been identified on the basis of power system simulation studies	<input type="checkbox"/>	<input checked="" type="checkbox"/>	
30	a) Is the Disturbance recorder provided for Transformer feeder b) Whether standalone or built in Main relay c) Whether DR is having automatic fault record download facility to a central PC d) Whether DR is time synchronised with the GPS time synchronising equipment e) Whether DR analog channels contain line phase & neutral current and line phase & neutral voltage. f) Whether DR digital channel as a minimum contain the CB status, Main-I & II trip status, LBB trip status, Over-voltage trip status, Stub protn trip status, Permissive and direct carrier receive status, Line reactor trip status.	<input checked="" type="checkbox"/> Standalone <input type="checkbox"/> <input checked="" type="checkbox"/> <input checked="" type="checkbox"/> <input checked="" type="checkbox"/>	<input type="checkbox"/> built-in <input checked="" type="checkbox"/> <input type="checkbox"/> <input type="checkbox"/>	

Sr No	Check Points	Yes	No	Remarks
1	Independent Main-I and Main-II protection (of different make OR different type) is provided with carrier aided scheme	<input checked="" type="checkbox"/>	<input type="checkbox"/>	
2	Are the Main-I & Main-II relays connected to two separate DC sources (Group-A and Group-B)	<input checked="" type="checkbox"/>	<input type="checkbox"/>	
3	Is the Distance protection (Non-switched type, suitable for 1-ph & 3-ph tripping) as Main1 and Main2 provided to ensure selectivity & reliability for all faults in the shortest possible time	<input checked="" type="checkbox"/>	<input type="checkbox"/>	
4	Is both main-I & Main-II distance relay are numerical design having Quadrilateral or Polygon operating characteristic	<input checked="" type="checkbox"/>	<input type="checkbox"/>	
5	In the Main-I / Main-II Distance protection, Zone-I is set cover 80% of the protected line section	<input checked="" type="checkbox"/>	<input type="checkbox"/>	Z-1 cover 80%
6	In the Main-I / Main-II distance protection, Zone-2 is set cover 120% of the protected line section in case of Single circuit line and 150% in case of Double circuit line	<input checked="" type="checkbox"/>	<input type="checkbox"/>	Z-2 cover 150%
7	In the Main-I / Main-II distance protection, Zone-3 is set cover 120% of the total of protected line section plus longest line at remote end as a minimum.	<input checked="" type="checkbox"/>	<input type="checkbox"/>	Z-3 cover-120%(PL + Longest line at remote)
8	Resistive reach for Ground fault element set to give maximum coverage considering fault resistance, arc resistance & tower footing resistance. ( In case, It is not possible to set the ground fault and phase fault reaches separately, load point encroachment condition imposed on Phase fault resistive reach shall be applied)	<input checked="" type="checkbox"/>	<input type="checkbox"/>	
9	Resistive reach for Phase fault element set to give maximum coverage subject to check of possibility against load point encroachment considering minimum expected voltage and maximum load.	<input checked="" type="checkbox"/>	<input type="checkbox"/>	
10	In case of short lines, is manufacturers recommendation considered in respect of resistive setting vis a vis reactance setting to avoid overreach.	<input type="checkbox"/>	<input type="checkbox"/>	Not applicable
11	Is Zone-2 time delay of Main-I / Main-II distance relay set to 0.350 seconds ? In case any other value has been set for Zone-II timer, kindly specify the value and justification thereof.	<input checked="" type="checkbox"/>	<input type="checkbox"/>	500 ms
12	Is Zone-3 timer is set to provide discrimination with the operating time of relays at adjacent sections with which Zone-3 reach of relay is set to overlap. Please specify the Zone-3 time set.	<input checked="" type="checkbox"/>	<input type="checkbox"/>	1500 ms
13	Is Zone-4 reach set in reverse direction to cover expected levels of apparent bus bar fault resistance, when allowing for multiple in feeds from other circuits?	<input checked="" type="checkbox"/>	<input type="checkbox"/>	
14	Is reverse looking Zone-4 time delay set as Zone-2 time delay?	<input checked="" type="checkbox"/>	<input type="checkbox"/>	
15	Is Switch on to fault (SOTF) function provided in distance relay to take care of line energisation on fault? Whether SOTF initiation has been implemented using hardwire logic in case of Breaker and half switching scheme, whether initiation of line SOTF from CB closing has been interlocked with the other CB	<input checked="" type="checkbox"/> <input checked="" type="checkbox"/>	<input type="checkbox"/> <input type="checkbox"/>	
16	Whether VT fuse fail detection function has been correctly set to block the distance function operation on VT fuse failure	<input checked="" type="checkbox"/>	<input type="checkbox"/>	
17	Is the sensitive IDMT directional E/F relay (either separate relay or built-in function of Main relay) for protection against high resistive earth faults?	<input checked="" type="checkbox"/>	<input type="checkbox"/>	Built in Main-1 &2
18	Is additional element (Back-up distance) for remote back-up protection function provided in case of unit protection is used as Main relay for lines?	<input type="checkbox"/>	<input type="checkbox"/>	Not Applicable
19	In case of Cables, is unit protection provided as Main-I & Main-II protection with distance as back-up.	<input type="checkbox"/>	<input type="checkbox"/>	Not Applicable
20	Are the line parameters used for setting the relay verified by field testing	<input checked="" type="checkbox"/>	<input type="checkbox"/>	
21	Is Two stages Over-Voltage protection provided for 220 kV Lines? Do you apply grading in over-voltage setting for lines at one station. Please specify the setting values adopted for: Stage-I : (typical value - 106 to 112 % , delay : 4-7 Sec) Stage-II: (typical value - 140 to 150%, delay: 0 to 100msec.)	<input checked="" type="checkbox"/> <input checked="" type="checkbox"/>	<input type="checkbox"/> <input type="checkbox"/>	U>1 110% @ 3.0Sec U>2 140% @ 0.1Sec
22	Is 1-ph Auto --reclosing provided on 765, 400 & 220kV lines? Please specify the set value: Dead time: (typical 1 Sec) Reclaim time: (typical 25 Sec)	<input checked="" type="checkbox"/>	<input type="checkbox"/>	Dead Time 850 ms
23	Is the Distance communication. Scheme Permissive Over Reach (POR) applied for short lines and Permissive Under Reach (PUR) applied for long lines? If any other communication scheme has been applied, please provide the detail with justification thereof.	<input checked="" type="checkbox"/>	<input type="checkbox"/>	
24	Is the Current reversal guard logic for POR scheme provided on Double circuit lines?	<input type="checkbox"/>	<input checked="" type="checkbox"/>	
25	In case the protected line is getting terminated at a station having very low fault level i.e. HVDC terminal, whether week end-infeed feature has been enabled in respective distance relay or not	<input type="checkbox"/>	<input type="checkbox"/>	Not applicable
26	In case of protected line is originating from nuclear power station, are the special requirement (stability of nuclear plant auxiliaries) as required by them has been met	<input type="checkbox"/>	<input type="checkbox"/>	Not applicable
27	What line current , Voltage and Load angle have been considered for Load encroachment blinder setting and what is the resultant MVA that the line can carry without load encroachment. (In the absence of Load encroachment blinder function, this limit shall be applied to Zone-3 phase fault resistive reach.)			Not Active
28	a) What are the Zones blocked on Power swing block function: b) Setting for Unblock timer: (typical 02 second) c) Out of Step trip enabled	Z1 02 Sec <input type="checkbox"/>	Z2 / Z3 / Z4 <input checked="" type="checkbox"/>	Trip provided in Zone-1, All higher zones are blocked.
29	Whether the location of Out of step relay has been identified on the basis of power system simulation studies	<input type="checkbox"/>	<input checked="" type="checkbox"/>	
30	a) Is the Disturbance recorder provided for Transformer feeder b) Whether standalone or built in Main relay c) Whether DR is having automatic fault record download facility to a central PC d) Whether DR is time synchronised with the GPS time synchronising equipment e) Whether DR analog channels contain line phase & neutral current and line phase & neutral voltage. f) Whether DR digital channel as a minimum contain the CB status, Main-I & II trip status, LBB trip status, Over-voltage trip status, Stub protn trip status, Permissive and direct carrier receive status, Line reactor trip status.	<input checked="" type="checkbox"/> Standalone <input type="checkbox"/> <input checked="" type="checkbox"/> <input checked="" type="checkbox"/> <input checked="" type="checkbox"/> <input checked="" type="checkbox"/>	<input type="checkbox"/> built-in <input checked="" type="checkbox"/> <input type="checkbox"/> <input type="checkbox"/> <input type="checkbox"/>	

Sr No	Check Points	Yes	No	Remarks
1	Independent Main-I and Main-II protection (of different make OR different type) is provided with carrier aided scheme	<input checked="" type="checkbox"/>	<input type="checkbox"/>	
2	Are the Main-I & Main-II relays connected to two separate DC sources (Group-A and Group-B)	<input checked="" type="checkbox"/>	<input type="checkbox"/>	
3	Is the Distance protection (Non-switched type, suitable for 1-ph & 3-ph tripping) as Main1 and Main2 provided to ensure selectivity & reliability for all faults in the shortest possible time	<input checked="" type="checkbox"/>	<input type="checkbox"/>	
4	Is both main-I & Main-II distance relay are numerical design having Quadrilateral or Polygon operating characteristic	<input checked="" type="checkbox"/>	<input type="checkbox"/>	
5	In the Main-I / Main-II Distance protection, Zone-I is set cover 80% of the protected line section	<input checked="" type="checkbox"/>	<input type="checkbox"/>	Z-1 cover 80%
6	In the Main-I / Main-II distance protection, Zone-2 is set cover 120% of the protected line section in case of Single circuit line and 150% in case of Double circuit line	<input checked="" type="checkbox"/>	<input type="checkbox"/>	Z-2 cover 150%
7	In the Main-I / Main-II distance protection, Zone-3 is set cover 120% of the total of protected line section plus longest line at remote end as a minimum.	<input checked="" type="checkbox"/>	<input type="checkbox"/>	Z-3 cover-120%(PL + Longest line at remote)
8	Resistive reach for Ground fault element set to give maximum coverage considering fault resistance, arc resistance & tower footing resistance. (In case, It is not possible to set the ground fault and phase fault reaches separately, load point encroachment condition imposed on Phase fault resistive reach shall be applied)	<input checked="" type="checkbox"/>	<input type="checkbox"/>	
9	Resistive reach for Phase fault element set to give maximum coverage subject to check of possibility against load point encroachment considering minimum expected voltage and maximum load.	<input checked="" type="checkbox"/>	<input type="checkbox"/>	
10	In case of short lines, is manufacturers recommendation considered in respect of resistive setting vis a vis reactance setting to avoid overreach.	<input type="checkbox"/>	<input type="checkbox"/>	Not applicable
11	Is Zone-2 time delay of Main-I / Main-II distance relay set to 0.350 seconds ? In case any other value has been set for Zone-II timer, kindly specify the value and justification thereof.	<input checked="" type="checkbox"/>	<input type="checkbox"/>	500 ms
12	Is Zone-3 timer is set to provide discrimination with the operating time of relays at adjacent sections with which Zone-3 reach of relay is set to overlap. Please specify the Zone-3 time set.	<input checked="" type="checkbox"/>	<input type="checkbox"/>	1500 ms
13	Is Zone-4 reach set in reverse direction to cover expected levels of apparent bus bar fault resistance, when allowing for multiple in feeds from other circuits?	<input checked="" type="checkbox"/>	<input type="checkbox"/>	
14	Is reverse looking Zone-4 time delay set as Zone-2 time delay?	<input checked="" type="checkbox"/>	<input type="checkbox"/>	
15	Is Switch on to fault (SOTF) function provided in distance relay to take care of line energisation on fault? Whether SOTF initiation has been implemented using hardwire logic in case of Breaker and half switching scheme, whether initiation of line SOTF from CB closing has been interlocked with the other CB	<input checked="" type="checkbox"/> <input checked="" type="checkbox"/>	<input type="checkbox"/> <input type="checkbox"/>	
16	Whether VT fuse fail detection function has been correctly set to block the distance function operation on VT fuse failure	<input checked="" type="checkbox"/>	<input type="checkbox"/>	
17	Is the sensitive IDMT directional E/F relay (either separate relay or built-in function of Main relay) for protection against high resistive earth faults?	<input checked="" type="checkbox"/>	<input type="checkbox"/>	Built in Main-1 & 2
18	Is additional element (Back-up distance) for remote back-up protection function provided in case of unit protection is used as Main relay for lines?	<input type="checkbox"/>	<input type="checkbox"/>	Not Applicable
19	In case of Cables, is unit protection provided as Main-I & Main-II protection with distance as back-up.	<input type="checkbox"/>	<input type="checkbox"/>	Not Applicable
20	Are the line parameters used for setting the relay verified by field testing	<input checked="" type="checkbox"/>	<input type="checkbox"/>	
21	Is Two stages Over-Voltage protection provided for 220 kV Lines? Do you apply grading in over-voltage setting for lines at one station. Please specify the setting values adopted for: Stage-I: (typical value - 106 to 112 %, delay : 4-7 Sec) Stage-II: (typical value - 140 to 150%, delay: 0 to 100msec.)	<input checked="" type="checkbox"/> <input checked="" type="checkbox"/>	<input type="checkbox"/> <input type="checkbox"/>	U>1 110% @ 3.0Sec U>2 140% @ 0.1Sec
22	Is 1-ph Auto-reclosing provided on 765, 400 & 220kV lines? Please specify the set value: Dead time: (typical 1 Sec) Reclaim time: (typical 25 Sec)	<input checked="" type="checkbox"/>	<input type="checkbox"/>	Dead Time 850 ms
23	Is the Distance communication. Scheme Permissive Over Reach (POR) applied for short lines and Permissive Under Reach (PUR) applied for long lines? If any other communication scheme has been applied, please provide the detail with justification thereof.	<input checked="" type="checkbox"/>	<input type="checkbox"/>	
24	Is the Current reversal guard logic for POR scheme provided on Double circuit lines?	<input type="checkbox"/>	<input checked="" type="checkbox"/>	
25	In case the protected line is getting terminated at a station having very low fault level i.e. HVDC terminal, whether weak end-feed feature has been enabled in respective distance relay or not	<input type="checkbox"/>	<input type="checkbox"/>	Not applicable
26	In case of protected line is originating from nuclear power station, are the special requirement (stability of nuclear plant auxiliaries) as required by them has been met	<input type="checkbox"/>	<input type="checkbox"/>	Not applicable
27	What line current, Voltage and Load angle have been considered for Load encroachment blinder setting and what is the resultant MVA that the line can carry without load encroachment. (In the absence of Load encroachment blinder function, this limit shall be applied to Zone-3 phase fault resistive reach.)			Not Active
28	a) What are the Zones blocked on Power swing block function: b) Setting for Unblock timer: (typical 02 second) c) Out of Step trip enabled	Z1 02 Sec <input type="checkbox"/>	<b>Z2 / Z3 / Z4</b> <input checked="" type="checkbox"/>	Trip provided in Zone-1, All higher zones are blocked.
29	Whether the location of Out of step relay has been identified on the basis of power system simulation studies	<input type="checkbox"/>	<input checked="" type="checkbox"/>	
30	a) Is the Disturbance recorder provided for Transformer feeder b) Whether standalone or built in Main relay c) Whether DR is having automatic fault record download facility to a central PC d) Whether DR is time synchronised with the GPS time synchronising equipment e) Whether DR analog channels contain line phase & neutral current and line phase & neutral voltage f) Whether DR digital channel as a minimum contain the CB status, Main-I & II trip status, LBB trip status, Over-voltage trip status, Stub protn trip status, Permissive and direct carrier receive status, Line reactor trip status.	<input checked="" type="checkbox"/> Standalone <input type="checkbox"/> <input checked="" type="checkbox"/> <input checked="" type="checkbox"/> <input checked="" type="checkbox"/> <input checked="" type="checkbox"/>	<input type="checkbox"/> built-in <input checked="" type="checkbox"/> <input type="checkbox"/> <input type="checkbox"/> <input type="checkbox"/> <input type="checkbox"/>	

bajaj ENERGY		Transmission line OHL-765KV Fatehabad Ckt #01		Remarks
Sr No	Check Points	Yes	No	
1	Independent Main-I and Main-II protection (of different make OR different type) is provided with carrier aided scheme	<input checked="" type="checkbox"/>	<input type="checkbox"/>	
2	Are the Main-I & Main-II relays connected to two separate DC sources (Group-A and Group-B)	<input checked="" type="checkbox"/>	<input type="checkbox"/>	
3	Is the Distance protection (Non-switched type, suitable for 1-ph & 3-ph tripping) as Main1 and Main2 provided to ensure selectivity & reliability for all faults in the shortest possible time	<input checked="" type="checkbox"/>	<input type="checkbox"/>	
4	Is both main-I & Main-II distance relay are numerical design having Quadrilateral or Polygon operating characteristic	<input checked="" type="checkbox"/>	<input type="checkbox"/>	
5	In the Main-I / Main-II Distance protection, Zone-1 is set cover 80% of the protected line section	<input checked="" type="checkbox"/>	<input type="checkbox"/>	Z-1 cover 80%
6	In the Main-I / Main-II distance protection, Zone-2 is set cover 120% of the protected line section in case of Single circuit line and 150% in case of Double circuit line	<input checked="" type="checkbox"/>	<input type="checkbox"/>	Z-2 cover 120%
7	In the Main-I / Main-II distance protection, Zone-3 is set cover 120% of the total of protected line section plus longest line at remote end as a minimum.	<input checked="" type="checkbox"/>	<input type="checkbox"/>	Z-3 cover-120%(PL + Longest line at remote)
8	Resistive reach for Ground fault element set to give maximum coverage considering fault resistance, arc resistance & tower footing resistance. ( In case, It is not possible to set the ground fault and phase fault reaches separately, load point encroachment condition imposed on Phase fault resistive reach shall be applied)	<input checked="" type="checkbox"/>	<input type="checkbox"/>	
9	Resistive reach for Phase fault element set to give maximum coverage subject to check of possibility against load point encroachment considering minimum expected voltage and maximum load.	<input checked="" type="checkbox"/>	<input type="checkbox"/>	
10	In case of short lines, is manufacturers recommendation considered in respect of resistive setting vis a vis reactance setting to avoid overreach.	<input type="checkbox"/>	<input type="checkbox"/>	Not applicable
11	Is Zone-2 time delay of Main-I / Main-II distance relay set to 0.350 seconds ? In case any other value has been set for Zone-II timer, kindly specify the value and justification thereof.	<input checked="" type="checkbox"/>	<input type="checkbox"/>	350 ms
12	Is Zone-3 timer is set to provide discrimination with the operating time of relays at adjacent sections with which Zone-3 reach of relay is set to overlap. Please specify the Zone-3 time set.	<input checked="" type="checkbox"/>	<input type="checkbox"/>	1500 ms
13	Is Zone-4 reach set in reverse direction to cover expected levels of apparent bus bar fault resistance, when allowing for multiple in feeds from other circuits?	<input checked="" type="checkbox"/>	<input type="checkbox"/>	
14	Is reverse looking Zone-4 time delay set as Zone-2 time delay?	<input checked="" type="checkbox"/>	<input type="checkbox"/>	
15	Is Switch on to fault (SOTF) function provided in distance relay to take care of line energisation on fault?	<input checked="" type="checkbox"/>	<input type="checkbox"/>	
	Whether SOTF initiation has been implemented using hardwire logic In case of Breaker and half switching scheme, whether initiation of line SOTF from CB closing has been interlocked with the other CB	<input checked="" type="checkbox"/>	<input type="checkbox"/>	
16	Whether VT fuse fail detection function has been correctly set to block the distance function operation on VT fuse failure	<input checked="" type="checkbox"/>	<input type="checkbox"/>	
17	Is the sensitive IDMT directional E/F relay (either separate relay or built-in function of Main relay) for protection against high resistive earth faults?	<input checked="" type="checkbox"/>	<input type="checkbox"/>	Built in Main-1 & 2
18	Is additional element (Back-up distance) for remote back-up protection function provided in case of unit protection is used as Main relay for lines?	<input type="checkbox"/>	<input type="checkbox"/>	Not Applicable
19	In case of Cables, is unit protection provided as Main-I & Main-II protection with distance as back-up.	<input type="checkbox"/>	<input type="checkbox"/>	Not Applicable
20	Are the line parameters used for setting the relay verified by field testing	<input checked="" type="checkbox"/>	<input type="checkbox"/>	
21	Is Two stages Over-Voltage protection provided for 220 kV Lines?	<input checked="" type="checkbox"/>	<input type="checkbox"/>	
	Do you apply grading in over-voltage setting for lines at one station. Please specify the setting values adopted for: Stage-I: (typical value - 106 to 112 % , delay : 4-7 Sec) Stage-II: (typical value - 140 to 150%, delay: 0 to 100msec.)	<input checked="" type="checkbox"/>	<input type="checkbox"/>	U>1 109% @ 4.0Sec U>2 140% @ 0.1Sec
22	Is 1-ph Auto –reclosing provided on 765, 400 & 220kV lines? Please specify the set value: Dead time: (typical 1 Sec) Reclaim time: (typical 25 Sec)	<input checked="" type="checkbox"/>	<input type="checkbox"/>	Dead Time 850 ms
23	Is the Distance communication. Scheme Permissive Over Reach (POR) applied for short lines and Permissive Under Reach (PUR) applied for long lines? If any other communication scheme has been applied, please provide the detail with justification thereof.	<input checked="" type="checkbox"/>	<input type="checkbox"/>	
24	Is the Current reversal guard logic for POR scheme provided on Double circuit lines?	<input type="checkbox"/>	<input checked="" type="checkbox"/>	
25	In case the protected line is getting terminated at a station having very low fault level i.e. HVDC terminal, whether week end-infeed feature has been enabled in respective distance relay or not	<input type="checkbox"/>	<input type="checkbox"/>	Not applicable
26	In case of protected line is originating from nuclear power station, are the special requirement (stability of nuclear plant auxiliaries) as required by them has been met	<input type="checkbox"/>	<input type="checkbox"/>	Not applicable
27	What line current, Voltage and Load angle have been considered for Load encroachment blinder setting and what is the resultant MVA that the line can carry without load encroachment. (In the absence of Load encroachment blinder function, this limit shall be applied to Zone-3 phase fault resistive reach.)			Not Active
28	a) What are the Zones blocked on Power swing block function:	Z1	Z2 / Z3 / Z4	Trip provided in Zone-1, All higher zones are blocked.
	b) Setting for Unblock timer: (typical 02 second)	02 Sec		
	c) Out of Step trip enabled	<input type="checkbox"/>	<input checked="" type="checkbox"/>	
29	Whether the location of Out of step relay has been identified on the basis of power system simulation studies	<input type="checkbox"/>	<input checked="" type="checkbox"/>	
30	a) Is the Disturbance recorder provided for Transformer feeder	<input checked="" type="checkbox"/>	<input type="checkbox"/>	
	b) Whether standalone or built in Main relay	Standalone	built-in	
	c) Whether DR is having automatic fault record download facility to a central PC	<input type="checkbox"/>	<input checked="" type="checkbox"/>	
	d) Whether DR is time synchronised with the GPS time synchronising equipment	<input checked="" type="checkbox"/>	<input type="checkbox"/>	
	e) Whether DR analog channels contain line phase & neutral current and line phase & neutral voltage.	<input checked="" type="checkbox"/>	<input type="checkbox"/>	
	f) Whether DR digital channel as a minimum contain the CB status, Main-I & II trip status, LBB trip status, Over-voltage trip status, Stub protn trip status, Permissive and direct carrier receive status, Line reactor trip status.	<input checked="" type="checkbox"/>	<input type="checkbox"/>	

bajaj ENERGY		Transmission line OHL-765KV Fatehabad Ckt #02		Remarks
Sr No	Check Points	Yes	No	
1	Independent Main-I and Main-II protection (of different make OR different type) is provided with carrier aided scheme	<input checked="" type="checkbox"/>	<input type="checkbox"/>	
2	Are the Main-I & Main-II relays connected to two separate DC sources (Group-A and Group-B)	<input checked="" type="checkbox"/>	<input type="checkbox"/>	
3	Is the Distance protection (Non-switched type, suitable for 1-ph & 3-ph tripping) as Main1 and Main2 provided to ensure selectivity & reliability for all faults in the shortest possible time	<input checked="" type="checkbox"/>	<input type="checkbox"/>	
4	Is both main-I & Main-II distance relay are numerical design having Quadrilateral or Polygon operating characteristic	<input checked="" type="checkbox"/>	<input type="checkbox"/>	
5	In the Main-I / Main-II Distance protection, Zone-1 is set cover 80% of the protected line section	<input checked="" type="checkbox"/>	<input type="checkbox"/>	Z-1 cover 80%
6	In the Main-I / Main-II distance protection, Zone-2 is set cover 120% of the protected line section in case of Single circuit line and 150% in case of Double circuit line	<input checked="" type="checkbox"/>	<input type="checkbox"/>	Z-2 cover 120%
7	In the Main-I / Main-II distance protection, Zone-3 is set cover 120% of the total of protected line section plus longest line at remote end as a minimum.	<input checked="" type="checkbox"/>	<input type="checkbox"/>	Z-3 cover-120%(PL + Longest line at remote)
8	Resistive reach for Ground fault element set to give maximum coverage considering fault resistance, arc resistance & tower footing resistance. ( In case, It is not possible to set the ground fault and phase fault reaches separately, load point encroachment condition imposed on Phase fault resistive reach shall be applied)	<input checked="" type="checkbox"/>	<input type="checkbox"/>	
9	Resistive reach for Phase fault element set to give maximum coverage subject to check of possibility against load point encroachment considering minimum expected voltage and maximum load.	<input checked="" type="checkbox"/>	<input type="checkbox"/>	
10	In case of short lines, is manufacturers recommendation considered in respect of resistive setting vis a vis reactance setting to avoid overreach.	<input type="checkbox"/>	<input type="checkbox"/>	Not applicable
11	Is Zone-2 time delay of Main-I / Main-II distance relay set to 0.350 seconds ? In case any other value has been set for Zone-II timer, kindly specify the value and justification thereof.	<input checked="" type="checkbox"/>	<input type="checkbox"/>	350 ms
12	Is Zone-3 timer is set to provide discrimination with the operating time of relays at adjacent sections with which Zone-3 reach of relay is set to overlap. Please specify the Zone-3 time set.	<input checked="" type="checkbox"/>	<input type="checkbox"/>	1500 ms
13	Is Zone-4 reach set in reverse direction to cover expected levels of apparent bus bar fault resistance, when allowing for multiple in feeds from other circuits?	<input checked="" type="checkbox"/>	<input type="checkbox"/>	
14	Is reverse looking Zone-4 time delay set as Zone-2 time delay?	<input checked="" type="checkbox"/>	<input type="checkbox"/>	
15	Is Switch on to fault (SOTF) function provided in distance relay to take care of line energisation on fault?	<input checked="" type="checkbox"/>	<input type="checkbox"/>	
	Whether SOTF initiation has been implemented using hardwire logic In case of Breaker and half switching scheme, whether initiation of line SOTF from CB closing has been interlocked with the other CB	<input checked="" type="checkbox"/>	<input type="checkbox"/>	
16	Whether VT fuse fail detection function has been correctly set to block the distance function operation on VT fuse failure	<input checked="" type="checkbox"/>	<input type="checkbox"/>	
17	Is the sensitive IDMT directional E/F relay (either separate relay or built-in function of Main relay) for protection against high resistive earth faults?	<input checked="" type="checkbox"/>	<input type="checkbox"/>	Built in Main-1 & 2
18	Is additional element (Back-up distance) for remote back-up protection function provided in case of unit protection is used as Main relay for lines?	<input type="checkbox"/>	<input type="checkbox"/>	Not Applicable
19	In case of Cables, is unit protection provided as Main-I & Main-II protection with distance as back-up.	<input type="checkbox"/>	<input type="checkbox"/>	Not Applicable
20	Are the line parameters used for setting the relay verified by field testing	<input checked="" type="checkbox"/>	<input type="checkbox"/>	
21	Is Two stages Over-Voltage protection provided for 220 kV Lines?	<input checked="" type="checkbox"/>	<input type="checkbox"/>	U>1 109% @ 4.0Sec U>2 140% @ 0.1Sec
	Do you apply grading in over-voltage setting for lines at one station. Please specify the setting values adopted for: Stage-I: (typical value - 106 to 112 % , delay : 4-7 Sec) Stage-II: (typical value - 140 to 150%, delay: 0 to 100msec.)	<input checked="" type="checkbox"/>	<input type="checkbox"/>	
22	Is 1-ph Auto –reclosing provided on 765, 400 & 220kV lines? Please specify the set value: Dead time: (typical 1 Sec) Reclaim time: (typical 25 Sec)	<input checked="" type="checkbox"/>	<input type="checkbox"/>	Dead Time 850 ms
23	Is the Distance communication. Scheme Permissive Over Reach (POR) applied for short lines and Permissive Under Reach (PUR) applied for long lines? If any other communication scheme has been applied, please provide the detail with justification thereof.	<input checked="" type="checkbox"/>	<input type="checkbox"/>	
24	Is the Current reversal guard logic for POR scheme provided on Double circuit lines?	<input type="checkbox"/>	<input checked="" type="checkbox"/>	
25	In case the protected line is getting terminated at a station having very low fault level i.e. HVDC terminal, whether week end-infeed feature has been enabled in respective distance relay or not	<input type="checkbox"/>	<input type="checkbox"/>	Not applicable
26	In case of protected line is originating from nuclear power station, are the special requirement (stability of nuclear plant auxiliaries) as required by them has been met	<input type="checkbox"/>	<input type="checkbox"/>	Not applicable
27	What line current, Voltage and Load angle have been considered for Load encroachment blinder setting and what is the resultant MVA that the line can carry without load encroachment. (In the absence of Load encroachment blinder function, this limit shall be applied to Zone-3 phase fault resistive reach.)			Not Active
28	a) What are the Zones blocked on Power swing block function:	Z1	Z2 / Z3 / Z4	Trip provided in Zone-1, All higher zones are blocked.
	b) Setting for Unblock timer: (typical 02 second)	02 Sec		
	c) Out of Step trip enabled	<input type="checkbox"/>	<input checked="" type="checkbox"/>	
29	Whether the location of Out of step relay has been identified on the basis of power system simulation studies	<input type="checkbox"/>	<input checked="" type="checkbox"/>	
30	a) Is the Disturbance recorder provided for Transformer feeder	<input checked="" type="checkbox"/>	<input type="checkbox"/>	
	b) Whether standalone or built in Main relay	Standalone	built-in	
	c) Whether DR is having automatic fault record download facility to a central PC	<input type="checkbox"/>	<input checked="" type="checkbox"/>	
	d) Whether DR is time synchronised with the GPS time synchronising equipment	<input checked="" type="checkbox"/>	<input type="checkbox"/>	
	e) Whether DR analog channels contain line phase & neutral current and line phase & neutral voltage.	<input checked="" type="checkbox"/>	<input type="checkbox"/>	
	f) Whether DR digital channel as a minimum contain the CB status, Main-I & II trip status, LBB trip status, Over-voltage trip status, Stub protn trip status, Permissive and direct carrier receive status, Line reactor trip status.	<input checked="" type="checkbox"/>	<input type="checkbox"/>	

<b>Third Party Production Audit Product and Compliance in r/o 220/132/33kV Sub Station, Sub-Division, HPSEBL, Kunihar.</b>	
1	220 Kv both Bus Bars Protectors are kept out of service, the same needs to be taken in.
Reply	The Bus Bars Protection Panels is not commissioned. The matter is take up with the higher authorities of HPSEBL & ABB India Ltd. And the Commissioning of panel will be done soon.
2	132 Kv bus Bars protection is not available/installed, the same needs to be implemented for reliable operation of protection scheme and clearing of faults.
Reply	A Scheme for replacement of all 132 kv control and relay panels is submitted to higher authorities in PSDF - II scheme in which 132 kv bus bars protection panel is also available.
3	In all MICOM P444 relays all the tripping outputs settings needs to be changed to DWELL with pickup value 100ms in PSL logic
Reply	All the suggested setting will be changed during Protection and testing to be planned for 11.12.2024 with proper shut down.
4	In all 220 kv line feeders auto release function is available but not in service. Same needs to be taken into service as per latest guidelines.
Reply	The auto reclosure function is available in 220 kv line feeders and same is activated for protection purpose
5	In both ABB and MICOM relays circuit breaker open status is to be added in DR for proper analysis of the Fault.
Reply	Matters has been taken up with Protection and Testing Unit , Soon it will be resolved.
6	In all 220 kv and 132 kv line feeders, there is no PLCC /DTPC available/installed. As the communication is through OPGW, DTPC needs to be installed for implementation of auto-reclose function.
Reply	Matters has been taken up with Protection and Testing Unit , Soon it will be resolved.
7	In 132 kv Distance protection is to be implemented in Barotiwala Ckt - 1 & 2 and Solan 1 & 2 feeders.
Reply	A Scheme for replacement of all 132 kv control and relay panels is submitted to higher authorities in PSDF - II scheme.
8	In 132 Kv feeders there is no LBB protection available, same needs to be implemented.
Reply	A Scheme for replacement of all 132 kv control and relay panels is submitted to higher authorities in PSDF - II scheme.
9	In 132 kv line C&P panels, most of the aux relays are installed but are not healthy such there is no provision of alarm in case of tripping or trouble in other feeders. Non-reporting of tripping, and important alarms like CB lockout, SF6 low, Air pressure low etc. result in poor monitoring and delay in restoration/rectification , so the panels/relays needs to be replaced/modified.
Reply	All 132 kv control and relay panel installed at 220 kv sub-station Kunihar are old and A Scheme for replacement of all 132 kv control and relay panels is submitted to higher authorities in PSDF - II scheme.
10	In all 132 kv line feeders Auto reclose function needs to be implemented as per latest guidelines
Reply	All 132 kv control and relay panel installed at 220 kv sub-station Kunihar are old and A Scheme for replacement of all 132 kv control and relay panels is submitted to higher authorities in PSDF - II scheme.
11	SLD of ACDB and DCDB shall be made available.
Reply	Prepared.

  
 Sr. Executive Engineer,  
 220 KV ES Division,  
 HPSEBL Kunihar.



12	Time Synchronization of all IEDs of 220 kv and 132 kv found to fail. There is no GPS signal available in GPS clock due to this all IED's are not time synced. This has to be rectified.
Reply	Matters has been taken up with ABB and soon it will be rectified.
13	No protection testing record available at the site (Pre-Commissioning/Route testing). It is observed that there is no practice of testing the protection system functions. Proper SOP for testing, monitoring and record-keeping of protection system needs to adopt for the betterment of the protection system.
Reply	The testing of relays of ICT - I and ICT - II were done during the periodical testing of Transformers and the matter of testing all the feeder relays during the periodical testing of sub-station is take up with protection and testing team of HPSEBI
14	Protection spares are not available at sites. Healthy relay needs to be kept in a suitable, so that same can be utilized during contingencies. Consumable spares eg. FO patch cords, indication lamps, semaphores, indicating meters etc need to be kept at site.
Reply	Few protection spares procured and rest of raise the matter to higher Authorities.
15	Trip Circuit supervision is a very important monitoring mechanism same need to be implemented in all 132 kv systems on a priority basis.
Reply	The panels and wiring of 132 kv system is old and the relays installed these panels are electromechanical type which are not in healthy condition. A Scheme for replacement of all 132 kv cntrol and relay panels is submitted to higher authorities in PSDF - II scheme.
16	DC Earth fault in sources 01 and 02 needs to be removed, present DC system condition is. (A) DC - 1: +ve to -ve 242.3 V, +Ve to E- 140.0 V, -Ve to E- 105.0 V (B) DC- 2: +Ve to -Ve- 248.9V, +Ve toE- 75.0 V, -Ve to E- 170.6 V, there is DC Earth Fault in DC-2, which needs to be rectified.
Reply	For rectification of DC Earth fault the sub-station maintenance team is performing regular duties such as replacement of old DCMCB's Dc fuse and also replacing the old damage terminal blocks.

  
**Sr. Executive Engineer,**  
**220 KV ES Division,**  
**HPSEBL Kunihar**





# **Power Transmission Corporation of Uttarakhand Limited**

(A Govt. of Uttarakhand Undertaking)

Corporate ID No.: U40101UR2004SGC028675

## **FINAL REPORT**

### **Protection Audit**

**220/132KV Pantnagar Substation**

**Submitted**

**By**



**CENTRAL BOARD OF IRRIGATION & POWER**

**NEW DELHI**





केन्द्रीय सिंचाई व शक्ति मंडल  
CENTRAL BOARD OF IRRIGATION AND POWER

Order No.: 376/SE (T&C)/PTCUL/(H). dated: 29.09.2023

25<sup>th</sup> June 2024

# Protection Audit Report

FINAL PROTECTION AUDIT REPORT OF 220/132 KV PANTNAGAR SUBSTATION UNDER POWER TRANSMISSION CORPORATION OF UTTARAKHAND LIMITED (PTCUL), UTTARAKHAND.

Submitted  
To



**Power Transmission Corporation of Uttarakhand Limited**  
(A Govt. of Uttarakhand Undertaking)  
Corporate ID No.: U40101UR2004SGC028675

## Contents

<b>Disclaimer</b> .....	6
<b>1.0. Executive Summary</b> .....	7
<b>2.0. Introduction</b> .....	9
<b>2.1. Background</b> .....	9
<b>2.2. Scope of Work</b> .....	9
<b>2.3. Audit Rationale</b> .....	10
<b>2.4. Audit Process</b> .....	11
<b>2.5. About Power Transmission Corporation of Uttarakhand Ltd. (PTCUL)</b> .....	13
<b>2.6. About Central Board of Irrigation &amp; Power (CBIP)</b> .....	14
<b>3.0. Preliminary Audit of Pantnagar Substation</b> .....	15
<b>3.1. General Information about Substation</b> .....	15
<b>3.2. Audit Team</b> .....	15
<b>3.3. Recommendation of last protection checking and validation</b> .....	16
<b>3.4. Review of existing settings at substation</b> .....	17
<b>3.5. Disturbance Recorder availability for the last 6 trippings</b> .....	17
<b>3.6. Chronic reason of tripping, if any</b> .....	18
<b>3.7. Major non-conformity/deficiency observed</b> .....	18
<b>4.0. List of Trippings</b> .....	21
<b>5.0. Observations and Recommendations</b> .....	28
<b>5.1. Reporting of all the Tripping with DR/EL</b> .....	28
<b>5.2. Development of centralized database of relay settings</b> .....	28
<b>5.3. Review of test results of relay and equipment</b> .....	29
<b>5.4. Availability of Testing Kits</b> .....	29
<b>5.5. Up-dation of PTCUL Protection Philosophy</b> .....	29
<b>5.6. Simulation based study of protection system</b> .....	29
<b>5.7. Capacity Building of protection team</b> .....	30
<b>5.8. Updated Fault Level/ Short Circuit Level and Network information</b> .....	30
<b>5.9. General Protection related observations</b> .....	30
<b>5.10. O&amp;M Manual</b> .....	30
<b>6.0. Station Specific Observation and Recommendations</b> .....	31
<b>6.1. Protection related observations and recommendations</b> .....	31
<b>6.2. Equipment related observations and recommendations</b> .....	31
<b>6.3. Auxiliary Equipment related observations and recommendations</b> .....	32
<b>Annexure – 1: Suggested List of Testing Instruments</b> .....	33
<b>Annexure – 2: Suggested List of Substation Equipments</b> .....	34
<b>Annexure – 3: Suggested List of Maintenance Equipments</b> .....	35

**Annexure – 4: Protection Code (IEGC 2023 Chapter 4).....36**

**Annexure – 5: Third Party Protection System Checking & Validation Template for a Substation (IEGC 2023 Annexure – 1).....41**

**Annexure – 6: Protection Philosophy/Protocol of Northern Region .....46**

**Annexure – 7: Work Order & Corrigendum.....52**

**Annexure – 8: Data Sheets .....60**

## ACRONYMS

<b>A</b>	Ampere
<b>AC</b>	Alternating Current
<b>AMP</b>	Annual Maintenance Plan
<b>CBIP</b>	Central Board of Irrigation and Power
<b>CT</b>	Current Transformer
<b>CVT</b>	Capacitive Voltage Transformer
<b>DC</b>	Direct Current
<b>DG</b>	Diesel Generator
<b>DPR</b>	Detailed Project Report
<b>DR</b>	Disturbance Recorder
<b>EL</b>	Event Logger
<b>EMTP</b>	Electromagnetic Transient Program
<b>EE</b>	Executive Engineer
<b>GPS</b>	Global Positioning System
<b>ICT</b>	Inter Connecting Transformer
<b>IEGC</b>	Indian Electricity Grid Code
<b>JE</b>	Junior Engineer
<b>KA</b>	Kilo Ampere
<b>KV</b>	Kilo Volt
<b>LBB</b>	Local Breaker Backup
<b>LEFT</b>	Earth Fault
<b>MVA</b>	Mega Volt Ampere
<b>NA</b>	Not Available
<b>NRPC</b>	Northern Regional Power Committee
<b>O&amp;M</b>	Operation & Maintenance
<b>OCC</b>	Operation Coordination Sub Committee

<b>PLCC</b>	Power Line Carrier Communication
<b>PSC</b>	Power System Sub Committee
<b>PSDF</b>	Power System Development Fund
<b>PT</b>	Potential Transformer
<b>PTCUL</b>	Power Transmission Corporation of Uttarakhand Limited.
<b>RLDC</b>	Regional Load Dispatch Centre
<b>RPC</b>	Regional Power Committee
<b>SAS</b>	Substation Automation System
<b>SE</b>	Superintendent Engineer
<b>SCADA</b>	Supervisory Control & Data Acquisition
<b>SLD</b>	Single Line Diagram
<b>SLDC</b>	State Load Dispatch Centre
<b>SOTF</b>	Switch On-To Fault
<b>SPS</b>	Special Protection Scheme
<b>T&amp;C</b>	Testing & Commissioning
<b>UJVNL</b>	Uttarakhand Jal Vidyut Nigam Ltd
<b>UPCL</b>	Uttarakhand Power Corporation Ltd
<b>WTI</b>	Winding Temperature Indicator

## Disclaimer

The protection audit has been carried out based on the guidelines provided under various documents mentioned in the report. For the purpose of audit, the auditor(s) have relied upon the data made available by the client and information & clarifications made available, in the written or verbal form, by the officials of clients during site visit and later.

The report is not for public distribution and has been furnished solely for information and must not be reproduced or redistributed to others, except those concerned. No one can use the report as a base for any claim, demand or cause of action and, also no one is responsible for any loss incurred based upon the content of this report.

While every effort is made to ensure the accuracy and completeness of information contained, CBIP takes no responsibility and assumes no liability for any error/ omission or accuracy of the information. Recipients of this material should rely on their own judgments and conclusions from relevant sources before taking any decision.

## 1.0. Executive Summary

PTCUL awarded the work of Third-Party Protection Audit of 2 nos. 400KV and 8 nos. 220KV substations of PTCUL (“Utility”) to CBIP. CBIP planned the audit as per Audit process provided under Protection Code within Indian Electricity Grid Code 2023. In addition, the guidelines of Ramakrishna Committee for checking and validation and NRPC guidelines for Third Party Audit were also adhered to. The CBIP manual on protection (manual no 247-Revised), NRPC protection philosophy were also referred.

As a part of audit process, Utility was asked to provide a set of information before start of audit. Team from CBIP consisting of Mr. Vijay Barthwal, Mr. M.R. Chauhan & Mr. Rounak Sen visited 220/132KV Pantnagar Substation during 26<sup>th</sup> – 29<sup>th</sup> December 2023 and preliminary audit report was submitted on the spot. The representatives of Utility were present during this process. Additional information was also sought from the Utility.

Based on the data made available by the Utility, the final report is being submitted to Utility. The details of audit process, data made available by Utility, observations from preliminary report and detailed observations and recommendations are provided in this report. Key observations and recommendations are summarized below.

### **General Observations and Recommendations for Organization Level implementation**

01. It is recommended that each substation to have a central repository for tripping reports, along with Time Synchronized DR/EL reports and analysis. A dedicated PC can be provided at each substation for the purpose.
02. The protection philosophy adopted by Utility, in general, is in alignment with protection philosophy adopted by NRPC. As the NRPC has recently updated the protection philosophy, PTCUL in consultation with SLDC may update protection philosophy for network not covered by NRPC too, if needed, and implement the same.
03. It is recommended that latest recommended relay settings, as per the NRPC protocol for 220KV & above Substations, along with setting calculations & parameters used for all the relays, be kept at each substation. This will help in proper fault analysis and ascertaining relay healthiness. Similarly, Relay settings for sub-stations below 220kV, based on any such protocol by SLDC, along with setting calculations and line parameters also needs to be maintained.
04. It is recommended that the detailed reports of test results for the relays and switchyard equipments be maintained at sub-station level.

05. Based on “Draft O&M Manual” of PTCUL and discussions with their officials, a list of testing equipment is suggested and enclosed at Annexure - 1. Also, a list of switchyard maintenance equipment is placed at annexure -3. It is recommended that the necessary testing and maintenance equipment at substation/Sub-division/Division be arranged for regular testing and maintenance of equipment at substations.
06. Simulation based studies or EMTP Studies should be carried out by the Utility, as per the requirement of IEGC-2023.
07. For the protection system and SAS, PTCUL may undertake capacity building exercise for the officials involved in these activities.
08. It is recommended that the updated network information and short circuit level should be periodically reviewed and maintained at central level for revising the setting as per requirement.
09. It is suggested that utility may carry out exhaustive safety and technical audit of sub-stations apart from protection audit, either internally or thru’ third party for implementing the best practices in the sub-station.
10. It is suggested that the existing draft O&M manual be updated to take care of latest developments.

#### **Observations and Recommendations for 220/132KV Pantnagar Substation**

01. From analysis of the tripping for last one year, no significant abnormal protection operation was noticed.
02. Bus-Bar protection is installed but not commissioned till date for 220KV bus. It is understood that PTCUL is in the process of inviting tender for getting the Bus-bar Protection installed. This needs to be expedited.
03. DC earth fault is observed in both DC systems. It was observed that both 220V battery banks were having earth faults. The necessary corrective action needs to be taken asap.
04. The SAS needs to be updated for the new elements introduced in the substation post-commissioning and kept functional.
05. GPS based Time Synchronisation of the relays is installed at the substation., However, the same is not synched with relay clock. Needs to be checked for missing GPS communication.
06. Based on inputs provided by utility and analysis of data a list of suggested switchyard and maintenance equipment for replacement is provided in Annexure – 2.
07. Updated SLD of Aux AC and DC system needs to be made available at Sub-station
08. Existing DG set needs to be replaced with suitable capacity DG Set
09. 2<sup>nd</sup> 48V DC Battery set needs to be provided.



## 2.0. Introduction

### 2.1. Background

The work has been awarded to the Central Board of Irrigation & Power (CBIP) vide Work Order Number: 376/SE (T&C)/PTCUL/(H), dated: 29.09.2023 for Protection Audit of 02 Nos. 400 KV and 08 Nos. 220 KV Substations at Uttarakhand, for Power Transmission Corporation of Uttarakhand Limited (PTCUL) in reference to the offer submitted by CBIP to PTCUL vide ref. no. P-1/CBIP/PTCUL/Audit/2023, dated: 11.09.2023. A Kick-Off Meeting was held between PTCUL and CBIP at the office of SE (T&C), PTCUL, Kathgodam, Haldwani on 26<sup>th</sup> October 2023. Detailed discussions were held regarding process and methodology of Execution and Submission of reports of Protection Audit. As per the above-mentioned meeting, a corrigendum was released by PTCUL vide ref. no. 394/SE (T&C)/PTCUL/(H), dated: 26.10.2023.

**As per the given order, the protection audit of following substations is to be carried out**

1. 400KV Rishikesh
2. 400KV Kashipur
3. 220KV Chamba
4. 220KV Rishikesh
5. 220KV Roorkee
6. 220KV Haridwar (SIDCUL)
7. 220KV Jhajra
8. 220KV Pantnagar
9. 220KV Haldwani
10. 220KV Mahuakheraganj

### 2.2. Scope of Work

Review of the implemented protection schemes/philosophy for 400/220 KV substations which includes protection of transmission lines, interconnecting transformers, line/bus reactors, bus bar, bus couplers etc. with respect to tripping in last one year as per latest guidelines of Ramakrishna committee/ CBIP/NRPC/International best practices, which includes review of the following:

- a. *Adequacy of primary and backup protection settings for protected equipment and suggest corrective measures.*
- b. *Availability/healthiness of PLCC communication links used for protection systems.*
- c. *Healthiness/adequacy of 220/110/50V DC system available at substations for protection application.*
- d. *Availability/healthiness of GPS system and time synchronization facility used for protection.*
- e. *Availability/healthiness of recording instruments like DRs /ELs for transmission lines protection.*
- f. *Test reports for assessing the healthiness of circuit breakers, CT & CVT based upon available test reports at sites.*
- g. *Field inspection of protection device for obsolescence of technology, suitability and healthiness.*
- h. *Prepare recommendation for replacement of obsolescence relays with compatible numerical relays will be provided.*
- i. *Checking of availability of DG Set / auxiliary DC supply at substations.*

### **2.3. Audit Rationale**

- a. PTCUL (Utility) has submitted a DPR for Replacement of certain equipment under PSDF scheme to Grid-India. Grid-India has asked PTCUL to carry out protection audit of certain substations.
- b. In addition, as per CERC IEGC 2023 Chapter-04 (Protection Code) Para - 15 (2) “All users shall also conduct third party protection audit of each substation at 220KV and above (132KV and above in NER) once in 5 years or earlier as advised by the respective RPC”.
- c. As per Para – 15 (4) of said Code, “The third-party protection audit report shall contain information sought in the format enclosed as Annexure–1. The protection audit reports, along with action plan for rectification of deficiencies detected, if any, shall be submitted to the respective RPC and RLDC or SLDC, as the case may be, within a month of submission of third-party audit report. The necessary compliance to such protection audit report shall be followed up regularly in the respective RPC”.
- d. Subsequently NRPC issued protection philosophy for Northern region developed in compliance of IEGC 2023, Version 2.0 which was approved in 71<sup>st</sup> NRPC meeting held on 29.01.2024. Accordingly, protection audit of 220KV and above Substations is being carried out by CBIP, as per Annexure -1 of IEGC-2023.

## 2.4. *Audit Process*

- PTCUL shall provide the following documents:
  - a. The Network Diagram, covering the relevant assets.
  - b. Latest relay settings adopted and calculations for respective substations and transmission lines.
  - c. Annual maintenance plan (AMP), including the schedule and activities covered under AMP.
  - d. Any specific issues covered under OCC and/or PSC of NRPC for relevant assets.
  
- For each substation, PTCUL to provide the check-list, which shall be verified during field visit.
  
- The minimum set of points, on which checking and validation to be carried out, is attached as per annexure – 4, for the following available power system elements at station, as per attached formats:

<b>S. No.</b>	<b>Elements</b>
1	Transmission Line
2	Bus Reactor/Line Reactor
3	Inter-Connecting Transformer [ICT]
4	Busbar
5	AC auxiliary system
6	DC auxiliary system
7	Communication system
8	Circuit Breaker Details
9	Current Transformer Details
10	Capacitive Voltage Transformers Details
11	Any other equipment/system relevant for protection system operation

- During field visit, no testing of equipment and relay shall be carried out. The visual inspection, operational log shall be considered for audit purpose, apart from the documents provided by PTCUL

- A calibrated multi-meter shall be provided at substation for checking AC and DC voltages and currents online, wherever feasible, without impacting the substation operations.
- The preliminary report shall be prepared on the site and shall be signed by all the parties present, as given below:

S. No.	Issues	Remarks
1	Recommendation of last protection checking and validation	Status of works and pending issues if any
2	Review of existing settings at substation	Recommended Action
3	Disturbance Recorder out/ available for last 6 tripping's (Y/N)	Recommended Action
4	Chronic reason of tripping, if any	Recommended Action
5	Major non-conformity / deficiency observed	Recommended Action

- **The Final summary shall specifically mention minimum following points:**
  - The settings and scheme adopted are in line with agreed protection philosophy or any accepted guidelines (e.g., Ramakrishna-committee guidelines or CBIP manual based).
  - The deviations from the RPC protection philosophy, if any and reasons for taking the deviations shall be recorded.
  - All the major general deficiencies shall be listed in detail along with remedial recommendations.
  - The cases of protection maloperation (last 1 year) shall be analysed from tripping reports and the causes of failure along with corrective actions and recommendations based on the findings.

## ***2.5. About Power Transmission Corporation of Uttarakhand Ltd. (PTCUL)***

The State of Uttarakhand's Power Transmission Utility, PTCUL, was formerly known as Power Transmission Company of Uttaranchal Ltd. According to the Uttar Pradesh State Reorganization Act 2000, this 27<sup>th</sup> state of the republic of India was formed on November 9, 2000, by dividing the Himalayan and surrounding North-Western districts of Uttar Pradesh.

The State of Uttarakhand in exercise of the power granted to it under section 63(4) of the State Re-Organization Act, 2000, formed two separate companies in power sector:

- Uttaranchal Jal Vidyut Nigam Ltd. (UJVNL) – For Generation of Hydro-Electricity in the State.
- Uttaranchal Power Corporation Ltd. (UPCL) – For Transmission and Distribution of Electricity in the state.

Enactment of the Electricity Act 2003, a distinct watershed in the Indian Power Sector, made it mandatory for all the States to restructure their SEBs. As per the provisions of Electricity Act 2003, the State Government separated power transmission business from UPCL which was left only with distribution of electricity.

In order to manage Power Transmission Operations, a new company called Power Transmission Corporation of Uttarakhand Ltd. was established. On 27<sup>th</sup> May, 2004, the firm was formed as a Government Company in accordance with section 617 of the Companies Act, 1956. It began operating from 1<sup>st</sup> June, 2004.

The company's corporate and registered office is located in Vidyut Bhawan, Saharanpur Road, Majra, Dehradun, next to the ISBT Crossing.

## **2.6. *About Central Board of Irrigation & Power (CBIP)***

The Government of India established the Central Board of Irrigation and Power in 1927, making it a Premier Institution. For the past 97 years, CBIP has provided committed services to the nation's professional associations, engineers, and individuals involved in the power, water resources, and renewable energy sectors. While serving the country equally and to great honour, CBIP has developed into an esteemed institution of international significance. CBIP is Indian chapter for 10 international organizations related to Power & Water resources sectors.

CBIP is involved in executing various activities such as, International Conferences, Technical Documents Publications, Training Activities, Research & Development, Consultancy Services including Technical, Protection & Safety Audits.

### 3.0. Preliminary Audit of Pantnagar Substation

#### 3.1. General Information about Substation

Sl. No.	Particulars	Details
1	Substation Name	220/132/33 KV Pantnagar Substation
2	Name of Owner Utility	Power Transmission Corporation of Uttarakhand Limited (PTCUL)
3	Voltage Level (s) or highest voltage level	220/132/33 KV
4	Short circuit current rating of all equipment (for all voltage level)	40kA and 50kA
5	Date of commissioning of the substation	4 <sup>th</sup> October 2006
6	Checking and validation date	26 <sup>th</sup> – 29 <sup>th</sup> December 2023

#### 3.2. Audit Team

##### Audit Team (CBIP)

- Mr. Vijay Barthwal
- Mr. M.R. Chauhan
- Mr. Rounak Sen

##### PTCUL Representative

- Mr. Asim Baig - Executive Engineer
- Mr. Ashutosh Pokhriyal - Assistant Engineer
- Ms. Nikita Darmwal - Junior Engineer

### 3.3. Recommendation of last protection checking and validation

As per the information received, previous protection audit was carried out by NRPC, dated: 27<sup>th</sup> July 2015.

a. **Following observation were recorded during previous audit**

Sl. No.	Observation	Current Status
1	220 KV Bus bar protection is out of service for the last more than two years after it tripped. Bus bar protection relay P633 is defective showing error code.	Bay Units are pending to be installed.
2	All 220 KV lines except 220KV Bareilly line, the main-1 & main-2 protection has same make & type of relay i.e. ALSTOM make P442. As per NRPC guide line main-1 & main-2 protection relay should be preferably of different make.	In the process of being replaced.
3	HMI of Bareilly line main-1 protection relay, HV side of- 2x160 MVA, 220/132 KV and 2 x 80 MVA, 132/33 KVA transformers-differential-relay is not working, due to which relay settings cannot be changed.	The relay is replaced.
4	Battery of main-1 & main-2 distance relay type P442 of 220 KV TATA motors line have been taken out a year back which may be put back for services for time synchronising.	Synchronization has taken place
5	GPS clock is not installed due to which time synchronization of relay is not there.	GPS Clock installed.
6	No PLCC is installed on 220 KV Pantnagar-Bareilly line. Other PLCC	PLCC is in the process of being installed.



Sl. No.	Observation	Current Status
	panels available with or without protection coupler at substation be commissioned	
7	Incoming supply from 400 KV Kashipur and 400 KV Bareilly not running in synchronism. Both sources are connected on separate 220 KV buses.	Both sources are synchronized.
8	About 60 nos. Ampere meters and volt meters are not working. Meters for replacement are available same be replaced at the earliest.	Meters have been replaced.
9	All the protection relays installed are numerical. For better operation of these relays, air conditioning be provided in the control room.	Air Conditioning has been provided.
10	DG set of suitable capacity be made available at Substation as a back-up source.	DG set if 25kVA is installed at site. However, it is not of sufficient capacity.

### ***3.4.Review of existing settings at substation***

- a. Utility has provided relay settings adopted for various feeders and transformers.
- b. The record of different relay setting calculations is not available at the substation level.
- c. All relays are numeric, therefore, as per internal protocol of utility relays are tested only at the time of commissioning/change in setting.
- d. Copy of test reports not available at substation level.

### ***3.5.Disturbance Recorder availability for the last 6 trippings***

- a. Utility is submitting Disturbance Recorder data for Inter-State Line 220KV Rudrapur-Bareilly Line to NRLDC Portal. The record is not maintained at substation level.

- b. For transformers and Intra-state lines, DR data is taken at station level, for analysis purpose, utility shall be submitting same with tripping analysis report.

### ***3.6. Chronic reason of tripping, if any***

- a. Based on list of tripping submitted by utility for last 12 months, ***no major tripping*** for 220/132KV Substation was observed. Most of the faults observed were transient in nature.
- b. During earthquakes in January & October 2023, 80 MVA Transformers tripped. Utility informed that due to loose Mercury Contact on WTI indicator, this problem was encountered. This was rectified by replacing the contact on 05/11/2023.
- c. 220KV Pantnagar – Bareilly Line gets auto-reclosed at Pantnagar but fails from the Bareilly end. The carrier-based tripping needs to be activated for successful auto-reclosure. PLCC panel installation for this line is being processed.
- d. The 33KV feeders are showing frequent trippings. As 2 nos. transformers are directly connecting 220KV Bus to 33KV switchyard, any failure of protection to operate at 33KV level, may result in fault clearing at 220KV level. Utility has explained that these tripping may be due to fault at downstream 11KV network, therefore, fault may not impact 220kV level.

### ***3.7. Major non-conformity/deficiency observed***

- a. Bus Bar Protection on 220KV Bus is not functional. Utility explained that the central unit of the busbar protection system is currently defective. The newly procured busbar relay, implemented through the PSDF scheme, is not compatible with the old bay units. The procurement of a compatible central unit is underway and is expected to be functional before March 31, 2024.
- b. No Bus Bar Protection is provided for 132KV.
- c. Some of the numerical relays are not provided with Time Sync Input and Communication Port. Therefore, these relays cannot be time synchronized and their information cannot be shared with SAS.

S. No.	Feeder name	Relay	Relay make
1	220KV Haldwani Line (LRPA)	Distance relay	MICOM P442
2	220KV Haldwani Line (LRPB)	Distance relay	MICOM P442
3	220KV Tata Motor (LRPA)	Distance relay	MICOM P442
4	220KV Tata Motor (LRPB)	Distance relay	MICOM P442
5	220KV Jafarpur Line (LRPB)	Distance relay	MICOM P442
6	132KV HZL	Distance relay	MICOM P442
7	132KV Rudrapur	Distance relay	MICOM P442
8	220KV B/B Protection	Peripheral unit	MICOM P742
9	TBC	LBB protection	MICOM P821
10	160MVA-I(HV)	O/C & E/F relay	MICOM P127
11	160MVA-II(HV)	O/C & E/F relay	MICOM P127
12	160MVA-I(LV)	O/C & E/F relay	MICOM P127
13	160MVA-II(LV)	O/C & E/F relay	MICOM P127
14	220KV Bus Coupler	O/C & E/F relay	MICOM P122
15	132KV Haldwani Line	O/C & E/F relay	MICOM P127
16	132KV Rudrapur Line	O/C & E/F relay	MICOM P127
17	132KV TBC	O/C & E/F relay	MICOM P821
18	80MVA T/F-I(HV)	O/C & E/F relay	MICOM P127
19	80MVA T/F-II(HV)	O/C & E/F relay	MICOM P127

- d. SAS has been commissioned. However, it was observed that it is not in regular use and therefore, some of the inputs are not available. Further, no historical data could be extracted.
- e. Both the 220V DC systems are showing severe earth-fault.
- f. Only one no. 48V battery Bank is provided.
- g. The Auxiliary DG set capacity is only 25 KVA, therefore, the backup provided by DG set, in case of emergency, is not sufficient.
- h. 2 nos. GPS Time Synchronization Systems are provided in the substation. While one system caters to SAS, the other caters to relays & other equipment of the substation. Time difference of more than 1.8 secs is observed.
- i. The events are recorded from individual relays. No separate Event Logger is provided. The SAS has the event logging capability but is NOT in regular use.

- j. Recommended relay settings with supporting calculations / parameters needs to be kept at substation.
- k. All the isolators are operated manually.
- l. The AC and DC system needs to be checked during maintenance to avoid earth faults in auxiliary system.
- m. Single line diagrams [SLDs] of Aux AC and DC supplies to be made available at substations for ready reference.

## 4.0. List of Trippings

Name of Feeder/TF	Relay	Date and Time of tripping	Date and Time of closing	Flag observed	Other end flags	Analysis of tripping	Category Code	Action Taken
80 MVA T/F I	Micom P643	24-01-2023 14:30 Hrs	24-01-2023 14:45 Hrs	Breaker Auto Trip, Breaker Trouble, Master Trip Relay Operated	NIL	T/F trip due to earthquake	NA	NA
220 KV PANTNAGAR -JAFARPUR LINE TRIP	Micom P442	33-01-2023 16:21 Hrs	30-01-2023 17:45 Hrs	Distance Prot. Operated, Distance trip, Fault Location - 5.065 Km, zone - 1 trip, IL1-6.176 kA, IL2-6.218 kA, IL3-144 A, VAN-65.05 KV, VBN-62.3 KV, VCN-126.31 KV	NIL	Transient Fault	NA	NA
CB-73,132 KV KATHGODAM LINE	Siemens	17-05-2023 15:44 Hrs	17-05-2023 16:02 Hrs	CP- Breaker Auto Trip, Distance protection operated, RP-Z1 trip, R, Y Trip, IL1-0.15 kA, IL2-2.08 kA, IL3-0.12 kA, Distance-13.15 Km.	Main Relay distance protection operated, Y Phase trip, loop L2-Earth, L1-0.01kA, L2-1.25kA, DISTANC E-34 Km.	Transient Fault	LEFT	NA

Name of Feeder/TF	Relay	Date and Time of tripping	Date and Time of closing	Flag observed	Other end flags	Analysis of tripping	Category Code	Action Taken
CB-82,220 KV JAEARPUR LINE	Micom	21-05-2023 14:15 Hrs	21-05-2023 14:35 Hrs	CP-distance Relay Trip, RP-Any Trip, Fault Distance-4.185 Km, Fault loop L3-N, Z1 Trip, IR-444.8Amp, IY-586.5 Amp, IB-4.017kA	CP-distance Relay Trip, RP-Any Trip, Fault Distance-14.70 Km, Fault loop L3-N, Z2 Trip, IR-430.5Amp IY-563.8 Amp IB-2.094 Kamp	CP-distance Relay Trip, RP-Any Trip, Fault Distance-4.185 Km, Fault loop L3-N, Z1 Trip, IR-444.8Amp, IY-586.5 Amp, IB-4.017KAmp	LEFT	NA
CB-73, 132 KV KATHGODAM LINE	Siemens	23-05-2023 23:09 Hrs	24-05-2023 02:45 Hrs	CP-Distance protection Start, Distance Protection trip, R.P-Z1, Distance Pick Up L2 E, Distance loop, Fault current-IL1-0.01 Kk, IL2-2.17 kA, IL3-0.01 kA, Distance-30.3 Km,	NIL	Transient Fault	LEFT	NA
160 MVA T/F -II	Micom P643	25-05-2023 08:16 HRS	25-05-2023 08:42 HRS	Over Current Fault, Ia-267 amp, Ib-273.7 amp, Ic-489.7 amp, In-266.7 Amp, Vab-213.6 KV, Vbc-215.8 KV, Vca-212.0 KV	NIL	NA	NA	NA

Name of Feeder/TF	Relay	Date and Time of tripping	Date and Time of closing	Flag observed	Other end flags	Analysis of tripping	Category Code	Action Taken
CB-88,220 KV PANTNAGAR LINE	ABB REL 650	25-05-2023 15:56 HRS	25-05-2023 16:10 HRS	Distance protection operated, R Phase trip, zone 1, IL1-4946.48 Amp, I2-252.27 Amp, I3-542.23 Amp	Not Tripped	Transient Fault	LEFT	NA
CB-88,220 KV PANTNAGAR LINE	ABB REL 650	25-05-2023 16:10 HRS	25-05-2023 19:18 HRS	Fault loop L1-L2, Fault Distance-1.8 Km, IL1-4945.90 Amp, IL2-3132.67 Amp, IL3-172.03-amp, Zone 1 trip, SOTF trip	Not Tripped	R phase jumper broken	NA	NA
220 KV HALDWANI LINE	NA	14-07-2023 14:01 Hrs	14-07-2023 14:17 Hrs	<b>Flags-</b> Distance Trip zone 1, Fault loop-L3N, Fault Location-19.37 Km, Fault current - IL1-223.5 Amp, IL2-222.9 Amp, IL3-2.895 Kamp, Voltage-Van-129.1 KV, Vbn-121.7 KV, Vcn-90.03 KV	<b>Flags-</b> Distance trip Zone1, Fault loop L3N, Distance-21.2 Km, Fault current-IL3-1.33 KA	Transient fault	LEFT	NA
220 KV BAREILLY LINE	NA	06-08- 2023 00:19 Hrs	06-08-2023 01:06 Hrs	Started Phase BN, Zone -1 trip, distance-20.30 Km, Ia-26.33 Amp, Ib-3.504Kamp, Ic-26 Amp	DPT G3.43 Kaen trip, Y phase trip, Zone-1 Distance -45.3 Km, fault current-3.43 kA	Transient fault	LEFT	NA

Name of Feeder/TF	Relay	Date and Time of tripping	Date and Time of closing	Flag observed	Other end flags	Analysis of tripping	Category Code	Action Taken
KASHIPUR LINE	NA	18-08- 2023 3:15 Hrs	18-08-2023 3:35 Hrs	Distance relay trip zone-1, R-phase trip, distance =4.229km, fault current IA=5419.54A, IB=241.41A, IC=324.98A, IN=5902.27A, VA=24.18KV, VB=132.41KV, VC=132.51KV,	Fault loop-RN, Distance trip zone-1, Distance - 55.94 Km, Fault current - IL1-2.419 kA, IN- 1.909 kA.	Transient fault	LEFT	NA
220KV BAREILLY LINE	NA	01-09-2023 03:22hr	01-09-2023 04:44Hrs	Distance trip zone-1, started phase A-N, fault location=13.89km , IA=4.212KA, IB=256A, IC=703.6 A, VAN=45.78KV, VB=133.7KV, VCN=129.1 KV 1, started phase A-N, fault	IA- 3207.88 Amp,Fault Location- 49.93 Km.	Supply Fail from another end	LEFT	Line patrolling done by O&M Wing.
220KV BAREILLY LINE	NA	14-09-2023 15:11 Hrs	14-09-2023 15:51 Hrs	Distance trip zone-1, started phase B-N fault location=43.02 km, IA=632.7 A, IB=1.206KA, IC=609.1 A, VAN-120.5 KV, VBN-98.6 KV, VCN-125.4KV B=133.7KV, VCN=129.2 KV.	IB-3.788 KA, Fault Location - 33.1Km	Transient fault	LEFT	Line patrolling done by O&M Wing.



Name of Feeder/TF	Relay	Date and Time of tripping	Date and Time of closing	Flag observed	Other end flags	Analysis of tripping	Category Code	Action Taken
220KV BAREILLY LINE	NA	14-09-2023 20:29Hrs	14-09-2023 21:27 Hrs	Distance trip zone-1, started phase A-N fault location=14.30 km, IA=3.921 KA, IB= 392.5A, IC=838.5 A, VAN=44.09 KV, VBN=129.6KV, VCN=124.8KV B=133.7KV, VCN=129.2 KV.	NA	Transient fault	LEFT	Line patrolling done by O&M Wing.
220 KV KASHIPUR LINE	NA	27-09-2023 11:18Hrs	27-09-2023 11:52 Hrs	Distance Protection start, Distance protection trip, Fault loop-L3N, distance-62.4km, IL1-21.5A, IL2-24.09A, IL3-2249.28A, IN-2262.60A,	IL3-3.71 KA, Distance-16.5 KM	Transient fault	LEFT	Line patrolling done by O&M Wing.
220 KV BAREILLY LINE	NA	03-10-2023 00:28hr	03-10-2023 01:24hr	Distance trip zone-1, started phase A-N, A/R Operated successfully. Tripped phase A, fault location= 3.874km, fault duration= 69.92ms, IA=5.725KA, IB=307.1A, IC=920.9A, VAN=16.31KV, VBN=136.2KV, VCN=131.4KV.	Fault location=6 1.05km, 86.23%, R-Phase current = 2.881KA.	Supply fail from other end.	LEFT	NA

Name of Feeder/TF	Relay	Date and Time of tripping	Date and Time of closing	Flag observed	Other end flags	Analysis of tripping	Category Code	Action Taken
80 MVA T/F I&H CB NO-	NA	03-10-2023 14:52 Hrs	03-10-2023 15:06 Hrs	Breaker Auto Trip, OTI/WTI Trip, Transformer Trouble Alarm	NA	T/F tripped due to earthquake	NA	NA
220 KV BAREILLY LINE	NA	15-10-2023 04:23hr	15-10-2023 06:04hr	Distance trip zone-1, started phase A-N, A/R operated successfully, Tripped phase A, fault location=7.149km, fault duration=69.98ms, IA=5.113KA, IB=316.8A, IC=930.9A, VAN=29.29KV, VBN=134.9KV, VCN=131.6KV.	Fault location =56.81km, R-Phase current=3.109KA.	Supply fail from other end.	LEFT	NA
132 KV HALDWANI LINE	NA	16-10-2023 13:13 Hrs	16-10-2023 13:38 Hrs	Distance trip zone-1, started phase C-N, Tripped phase C, fault location=20.3 km, IA=0.01KA, IB=0.01KA, IC=1.22KA,	NA Open From other End	Transient Fault	LEFT	NA
132 KV HALDWANI LINE	NA	16-10-2023 13:38 Hrs	17-10-2023 13:32 Hrs	Distance trip zone-1, started phase C-N, fault location=17.8 Km, IA=0.01KA, IB=0.01KA, IC=1.28KA,	NA Open From other End	Tree was found fallen on C Phase conductor	NA	NA

Name of Feeder/TF	Relay	Date and Time of tripping	Date and Time of closing	Flag observed	Other end flags	Analysis of tripping	Category Code	Action Taken
132 KV HALDWANI LINE	NA	22-10-2023 22:21 Hrs	22-10-2023 22:36 Hrs	Distance trip zone-1, RYB Trip, Distance pick-up L1, fault location=5.5 Km, IA=5.25 KA, IB=0.01KA, IC=0.01KA,	NA Open From other End	Transient Fault	NA	NA
132 KV HALDWANI LINE	NA	24-10-2023 5:20 Hrs	24-10-2023 5:30 Hrs	Distance trip zone-1, Distance Pickup L1, RYB trip, fault location=5.6 Km, IA=5.12 KA, IB=0.01KA, IC=0.01 KA,	NA Open From other End	Transient Fault	NA	NA
132 KV HALDWANI LINE	NA	07/11/2023 19:52 hrs	07/11/2023 20:12 hrs	Distance trip zone-1, fault Loop-L2-E, IA=0.00 KA, IB=2.11KA, IC=0.01KA.	N/A	Transient fault	LEFT	NA

## 5.0. Observations and Recommendations

### 5.1. Reporting of all the Tripping with DR/EL

- a. For the interstate lines, as per IEGC clause 37.2(c) and clause 15.3 of CEA grid standard, all the DR/EL reports shall be uploaded on Web Based Tripping Monitoring System “http://103.7.128.184/Account/Login.aspx” within 24 hours of the events. These are being submitted by substation to NRLDC portal, however the record of the same is not kept at substation level.

Status of submission of FIR/DR/EL/Tripping Report on NR Tripping Portal																	
Time Period: 1st January 2024 - 31st January 2024																	
S. No.	Utility	Total No. of tripping	First Information Report (Not Received)		Disturbance Recorder (Not Received)		Disturbance Recorder (NA) as informed by utility		Event Logger (Not Received)		Event Logger (NA) as informed by utility		Tripping Report (Not Received)		Tripping Report (NA) as informed by utility	Tripping Report (Not Received)	Remark
			Value	%	Value	%	Value	%	Value	%	Value	%					
36	SLDC-PS	29	2	7	13	6	57	13	5	54	35	0	55				
37	SLDC-RS	130	12	9	23	11	19	23	9	19	39	0	30	DR, EL & Tripping report need to be submitted			
38	SLDC-LK	6	0	0	0	4	0	0	4	0	1	3	33				
39	SLDC-UP	80	10	13	11	9	15	12	10	17	11	1	14				
40	STERLITE	1	0	0	0	0	0	0	0	0	0	1	0	Details received			
41	TANAKPUR-NH	4	1	25	1	0	25	1	0	25	1	0	25	DR, EL & Tripping report need to be submitted			
42	UNCHAHAR-NT	1	0	0	0	0	0	0	1	0	0	0	0	Details received			
Total in NR Region		520	147	28	169	66	37	171	70	38	185	17	37				

As per the IEGC provision under clause 37.2 (c), detailed tripping report along with DR & EL has to be furnished within 24 hrs of the occurrence of the event

Ref: NRPC 216 OCC Agenda (Annexure B.VIII)

- b. For the tripping of intra-state lines, the brief tripping reports are submitted to Divisional office. The DR/EL reports are downloaded by respective officials and forwarded, as per need basis. The record of these DR/EL is not kept at substations
- c. It is recommended that each substation to have a central repository of such tripping reports, along with DR/EL reports and analysis. A dedicated PC can be kept for this.

### 5.2. Development of centralized database of relay settings

- a. In 48th TCC & 70th NRPC Meeting (held on 17-18 Nov 2023), NRPC Committee has approved for development of a portal through PSDF for Centralized database containing details of relay settings for grid elements connected to 220 KV and above. Portal shall have other features including protection setting calculation tool. A nodal officer shall be providing this data at central portal.
- b. The relay settings for below 220KV are to be calculated by SLDC and/or central level. The relays are tested by substation officials as per need basis, but the record of recommended settings/ calculation is not kept at substation level. This makes it difficult to validate the settings and test results, in case of relay testing.

- c. It is recommended that latest recommended relay settings, as decided by RLDC for 220KV & above and by SLDC below 220KV along with setting calculations & parameters used for all the relays be kept at substation level. This will help in proper fault analysis and ascertaining relay healthiness.

### **5.3. *Review of test results of relay and equipment***

- a. Testing of most of the equipment is carried out, as per availability of shut-down and testing equipment. After testing, the test records are summarily recorded in testing register, with remarks as “tested. OK”.
- b. For the numeric relay testing, the testing is carried out by supplier at the time of installation and subsequently as per need basis, including at the time of change in settings.
- c. A draft O&M manual is available at PTCUL web-site, which includes various tests and their frequency, along with results. This manual is based on CERC/SERC regulations of 2004-2008. It is recommended that this manual may be updated and implemented and record of test values may be kept for future reference.

### **5.4. *Availability of Testing Kits***

- a. The availability of testing equipment is limited at each substation. For comprehensive testing of equipment, as per above para, sufficient testing kits at each substation/Sub-division/ Division level are required.
- b. Based on the O&M manual, it is recommended that sufficient quantity of testing instruments be made available at sites for regular testing of equipment. A suggested list of Testing Equipment is attached at Annexure – 1.

### **5.5. *Up-dation of PTCUL Protection Philosophy***

The protection philosophy adopted by Utility, in general, is in alignment with protection philosophy adopted by NRPC. As the NRPC has recently updated the protection philosophy, PTCUL in consultation with SLDC may update protection philosophy for network not covered by NRPC, if needed, and implement the same.

### **5.6. *Simulation based study of protection system***

As per IEGC, protection code, during audit the relay settings to be adopted shall be validated with simulation based or EMTP studies and details shall be enclosed in report. The current scope of audit was excluding these studies, therefore, Simulation based or EMTP Studies should be carried out by the Utility, as per the requirement of Grid Code.

### **5.7. Capacity Building of protection team**

During the discussions with officials at site, it was observed that the teams responsible for the protection system and SAS, needs to be updated on current trends on protection system, communication schemes and Sub-station automation. Utility may undertake capacity building exercise for the officials involved in these activities.

### **5.8. Updated Fault Level/ Short Circuit Level and Network information**

The fault level/ short circuit level for each substation is being calculated at central level. Such studies are carried out, as and when new elements are added in the network. This has impact on relay settings parameters and equipment ratings. It is recommended that the updated network information and short circuit level be maintained at central level for revising the setting as per requirement.

### **5.9. General Protection related observations**

The study of Fire protection system/ Nitrogen Injection Fire Protection System, Lightning Protection system, Earthing Mat/ Earthing Protection are not covered under protection audit. Utility may get a comprehensive technical and safety audit carried out internally or thru third party and corrective action for any discrepancy be taken up accordingly.

### **5.10. O&M Manual**

The Utility has a draft O&M manual uploaded on its website, which is being referred by working level officials as a guideline for regular O&M and testing functions. This manual needs to be updated to incorporate recent developments and approved for regular use in all sub-stations to bring uniformity in O&M and testing practices across the utility.

## 6.0. Station Specific Observation and Recommendations

### 6.1. Protection related observations and recommendations

- a. Bus Bar Protection on 220KV Bus is not functional. Utility explained that the central unit of the busbar protection system is currently defective. The newly procured busbar relay, implemented through the PSDF scheme, is not compatible with the old bay units. The procurement of a compatible central unit is underway and is expected to be functional before March 31, 2024. PTCUL needs to expedite.
- b. Some of the numerical relays are not provided with Time Sync Input and Communication Port. Therefore, these relays cannot be time synchronized and their information cannot be shared with SAS.
- c. SAS has been commissioned. However, it was observed that it is not in regular use and therefore, some of the inputs are not available. Further, no historical data could be extracted. The events are recorded from individual relays. No separate Event Logger is provided. The SAS has the event logging capability but is NOT in regular use, as new elements after commissioning of SAS are not incorporated. The SAS needs to be updated for the new elements introduced in the substation post-commissioning and kept functional.
- d. Both the 220V DC systems are showing severe earth-fault. The necessary corrective action needs to be taken asap to avoid any unwanted tripping in future.
- e. 2 nos. GPS Time Synchronization Systems are provided in the substation. While one system caters to SAS, the other caters to relays & other equipment of the substation. Time difference of more than 1.8 secs is observed. Many relays are not synched with either of the clocks.

### 6.2. Equipment related observations and recommendations

PTCUL has submitted a list of switchyard equipments to be replaced under PSDF funding, as per Annexure - 2. In view of the need of modern sub-stations, where automation of sub-station is of paramount importance, these replacements are required. Based on the specifications and healthiness of existing equipments, the list may be reviewed by PTCUL.

In addition, it is recommended that sufficient quantity of maintenance equipments be made available at sites. A suggested list of **Maintenance Equipment is attached at Annexure – 3.**

### **6.3. *Auxiliary Equipment related observations and recommendations***

- a. Single line diagrams [SLDs] of Aux AC and DC supplies to be made available at substations for ready reference.
- b. Only one no. 48V battery Bank is provided. Second set to be arranged for PLCC and SCADA operations.
- c. The **Auxiliary DG set** capacity is only 25 KVA, therefore, the backup provided by DG set, in case of emergency, is **not sufficient**.



## Annexure – 1: Suggested List of Testing Instruments

CBIP suggests the following list of testing instruments based on the approved O&M manual

Sl. No.	Testing Instruments
1	DCRM for Circuit Breaker
2	DC Earth Fault Locator
3	SF6 Gas Density Monitor
4	SF6 Gas Leakage detector/ Imaging Camera
5	CB Analyser
6	Earth Resistance Tester
7	Portable Digital Selective Level Meter cum Level Generator
8	Selective Level Generator
9	LA Leakage Current Analyser
10	Digital Multi-meter
11	Tong Tester
12	Tan Delta Test Kit
13	Digital Leakage Clamp Meter
14	Phase Sequence Indicator
15	Megger (5 kV)
16	Digital Capacitance Meter
17	CT Polarity Tester
18	PT Test Set

## Annexure – 2: Suggested List of Substation Equipments

The suggested list of Substation Equipments keeping in mind the necessity for the modernization and upgradation of substations.

Sl. No.	Equipment	Unit	Quantity
<b>A</b>	<b>220 kV Equipment</b>		
1	245 kV Isolator 3Ph, Single Pole (Standard)	Nos	3
<b>B</b>	<b>132 kV Equipment</b>		
1	145 kV Isolator 3Ph	Nos	2
<b>C</b>	<b>33 kV Equipment</b>		
1	33 kV Isolator 3Ph	Nos	2

### Annexure – 3: Suggested List of Maintenance Equipments

Sl. No.	Equipment
1	Oil Filter Machine
2	SF6 Gas Handling Plant
3	SF6 Gas Density Monitor
4	Thermo-Vision Camera Lines and Sub-Station
5	Binocular Vision Camera
6	SF6 Gas Leakage Imaging Camera
7	LA Leakage Current Analyser
8	Online DGA
9	Oil BDV Kit
10	Hydraulic Crimping Tool for different Types of ACSR Conductor
11	Hydraulic Conductor Cutter
12	Fork Lift 5 Ton Capacity
13	Digital Leakage Clamp Meter

A mobile van with test kits can be kept for optimizing the resources at various substations

## Annexure – 4: Protection Code (IEGC 2023 Chapter 4)

- **General**

1. This chapter covers the protection protocol, protection settings and protection audit plan of electrical systems.
2. There shall be a uniform protection protocol for the users of the grid:
  - a) for proper co-ordination of protection system in order to protect the equipment/system from abnormal operating conditions, isolate the faulty equipment and avoid unintended operation of protection system;
  - b) to have a repository of protection system, settings and events at regional level;
  - c) specifying timelines for submission of data;
  - d) to ensure healthiness of recording equipment including triggering criteria and time synchronization; and
  - e) to provide for periodic audit of protection system.

- **Protection protocol**

1. All users connected to the integrated grid shall provide and maintain effective protection system having reliability, selectivity, speed and sensitivity to isolate faulty section and protect element(s) as per the CEA Technical Standards for Construction, the CEA Technical Standards for Connectivity, the CEA (Grid Standards) Regulations, 2010, the CEA Technical Standards for Communication and any other applicable CEA Standards specified from time to time.
2. Back-up protection system shall be provided to protect an element in the event of failure of the primary protection system.
3. RPC shall develop the protection protocol and revise the same, after review from time to time, in consultation with the stakeholders in the concerned region, and in doing so shall be guided by the principle that minimum electrical protection functions for equipment connected with the grid shall be provided as per the CEA Technical Standards for Construction, the CEA Technical Standards for Connectivity, the CEA Technical Standards for Communication, the CEA (Grid Standards) Regulations, 2010, the CEA (Measures relating to Safety and Electric Supply) Regulations, 2010, and any other CEA standards specified from time to time.

4. The protection protocol in a particular system may vary depending upon operational experience. Changes in protection protocol, as and when required, shall be carried out after deliberation and approval of the concerned RPC.
5. Violation of the protection protocol of the region shall be brought to the notice of concerned RPC by the concerned RLDC or SLDC, as the case may be.

- **Protection settings**

1. RPCs shall undertake review of the protection settings, assess the requirement of revisions in protection settings and revise protection settings in consultation with the stakeholders of the respective region, from time to time and at least once in a year. The necessary studies in this regard shall be carried out by the respective RPCs. The data including base case (peak and off-peak cases) files for carrying out studies shall be provided by RLDC and CTU to the RPCs:
2. All users connected to the grid shall:
  - a) furnish the protection settings implemented for each element to respective RPC in a format as prescribed by the concerned RPC;
  - b) obtain approval of the concerned RPC for,
    - i. any revision in settings, and,
    - ii. implementation of new protection system;
  - c) intimate to the concerned RPC about the changes implemented in protection system or protection settings within a fortnight of such changes;
  - d) ensure correct and appropriate settings of protection as specified by the concerned RPC.
  - e) ensure proper coordinated protection settings.
3. RPCs shall:
  - a) maintain a centralized database and update the same on periodic basis in respect of their respective region containing details of relay settings for grid elements connected to 220 KV and above (132 KV and above in NER). RLDCs shall also maintain such database.
  - b) carry out detailed system studies, once a year, for protection settings and advise modifications / changes, if any, to the CTU and to all users and STUs of their respective regions. The data required to carry out such studies shall be provided by RLDCs and CTU.

- c) provide the database access to CTU and NLDC and to all users, RLDC, SLDCs, and STUs of the respective regions. The database shall have different access rights for different users.
4. The changes in the network and protection settings of grid elements connected to 220KV and above (132 KV and above in NER) shall be informed to RPCs by CTU and STUs, as the case may be.

The elements of network below 66KV and radial in nature which do not impact the National Grid may be excluded as finalized by the respective RPC.

- **Protection audit plan**

1. All users shall conduct internal audit of their protection systems annually, and any shortcomings identified shall be rectified and informed to their respective RPC. The audit report along with action plan for rectification of deficiencies detected, if any, shall be shared with respective RPC for users connected at 220 KV and above (132 KV and above in NER).
2. All users shall also conduct third party protection audit of each substation at 220 KV and above (132 KV and above in NER) once in five years or earlier as advised by the respective RPC.
3. After analysis of any event, each RPC shall identify a list of substations / and generating stations where third-party protection audit is required to be carried out and accordingly advise the respective users to complete third party audit within three months.
4. The third-party protection audit report shall contain information sought in the format enclosed as Annexure–1. The protection audit reports, along with action plan for rectification of deficiencies detected, if any, shall be submitted to the respective RPC and RLDC or SLDC, as the case may be, within a month of submission of third-party audit report. The necessary compliance to such protection audit report shall be followed up regularly in the respective RPC.
5. Annual audit plan for the next financial year shall be submitted by the users to their respective RPC by 31<sup>st</sup> October. The users shall adhere to the annual audit plan and report compliance of the same to their respective RPC.
6. Users shall submit the following protection performance indices of previous month to their respective RPC and RLDC on monthly basis for 220 KV and above (132 KV and above in NER) system, which shall be reviewed by the RPC:
  - a. The Dependability Index defined as

$$D = \frac{N_c}{N_c + N_f}$$

where,

$N_c$  is the number of correct operations at internal power system faults and

$N_f$  is the number of failures to operate at internal power system faults.

b. The Security Index defined as

$$S = \frac{N_c}{N_c + N_u}$$

where,

$N_c$  is the number of correct operations at internal power system faults

$N_u$  is the number of unwanted operations.

c. The Reliability Index defined as

$$R = \frac{N_c}{N_c + N_i}$$

where,

$N_c$  is the number of correct operations at internal power system faults

$N_i$  is the number of incorrect operations and is the sum of  $N_f$  and  $N_u$

7. Each user shall also submit the reasons for performance indices less than unity of individual element wise protection system to the respective RPC and action plan for corrective measures. The action plan will be followed up regularly in the respective RPC.
8. In case any user fails to comply with the protection protocol specified by the RPC or fails to undertake remedial action identified by the RPC within the specified timelines, the concerned RPC may approach the Commission with all relevant details for suitable directions.

- **System Protection Scheme (SPS)**

1. SPS for identified system shall have redundancies in measurement of input signals and communication paths involved up to the last mile to ensure security and dependability.
2. For the operational SPS, RLDC or NLDC, as the case may be, in consultation with the concerned RPC(s) shall perform regular load flow and dynamic studies and mock testing for reviewing SPS parameters & functions, at least once in a year.
3. RLDC or NLDC shall share the report of such studies and mock testing including any short comings to respective RPC(s). The data for such studies shall be provided by CTU to the concerned RPC, RLDC and NLDC.
4. The users and SLDCs shall report about the operation of SPS immediately and detailed report shall be submitted within three days of operation to the concerned RPC and RLDC in the format specified by the respective RPCs.
5. The performance of SPS shall be assessed as per the protection performance indices specified in these Regulations. In case, the SPS fails to operate, the concerned User shall take corrective actions and submit a detailed report on the corrective actions taken to the concerned RPC within a fortnight.

- **Recording instruments**

1. All users shall keep the recording instruments (disturbance recorder and event logger) in proper working condition.
2. The disturbance recorders shall have time synchronization and a standard format for recording analogue and digital signals which shall be included in the guidelines issued by the respective RPCs.
3. The time synchronization of the disturbance recorders shall be corroborated with the PMU data or SCADA event loggers by the respective RLDC. Disturbance recorders which are non-compliant shall be listed out for discussion at RPC.



## **Annexure – 5: Third Party Protection System Checking & Validation Template for a Substation (IEGC 2023 Annexure – 1)**

### **1. Introduction:**

- a. The audit reports, along with action plan for rectification of deficiencies found, if any, shall be submitted to RPC or RLDC within a month of submission of report by auditor.
- b. The third-party protection system checking shall be carried at site by the designated agency. The agency shall furnish two reports:
  - i. Preliminary Report: This report shall be prepared on the site and shall be signed by all the parties present.
  - ii. Detailed Report: This report shall be furnished by agency within one month after carrying out detailed analysis.

### **2. Checklist:**

- a. The protection system checklist shall contain information as per this Regulation.
  - i. General Information (to be provided prior to the checking as well as to be included in final report):
    - Substation name
    - Name of Owner Utility
    - Voltage Level (s) or highest voltage level
    - Short circuit current rating of all equipment (for all voltage level) (v) Date of commissioning of the substation
    - Checking and validation date
    - Record of previous tripping's (in last one year) and details of protection operation
    - Previous Relay Test Reports
    - Overall single line diagram (SLD) (x) AC aux SLD
    - DC aux SLD
    - SAS architecture diagram
    - SPS scheme implemented (if any)
  - b. The preliminary report shall inter-alia contain the following:

### FORMAT OF PRELIMINARY REPORT

S. No.	Issues	Remarks
1	<b>Recommendation of last protection checking and validation</b>	Status of works & pending issues if any
2	<b>Review of existing settings at substation</b>	Recommended Action
3	<b>Disturbance Recorder out/ available for last 6 trippings (Y/N)</b>	Recommended Action
4	<b>Chronic reason of tripping, if any</b>	Recommended Action
5	<b>Major non-conformity/deficiency observed</b>	Recommended Action

c. The **relay configuration check-list** for available power system elements at station:

- Transmission Line
- Bus Reactor/Line Reactor
- Inter-connecting Transformer
- Busbar Protection Relay
- AC auxiliary system
- DC auxiliary system
- Communication system
- Circuit Breaker Details
- Current Transformer details
- Capacitive Voltage Transformers Details
- Any other equipment/system relevant for protection system operation

d. The **minimum set of points on which checking & validation** shall be carried out is covered in this clause. The detailed list shall be prepared by checking and validation team in consultation with concerned entity, RLDC and RPC.

**i. Transmission Line Distance Protection/Differential Protection;**

- Name and Length of Line
- Whether series compensated or not
- Mode of communication used (PLCC/OPGW)
- Relay Make and Model for Main-I and Main-II
- List of all active protections & settings

- Carrier aided scheme if any
- Status of Power Swing/Out of Step/SOTF/Breaker Failure/Broken Conductor/STUB/Fault Locator/DR/VT fuse fail/Oversvoltage Protection/Trip Circuit supervision/Auto-reclose/Load encroachment etc.
- Relay connected to Trip Coil-1 or 2 or both i. CT ratio and PT ratio
- Feed from DC supply-1 or 2
- Connected to dedicated CT core (mention name)
- Other requirements for protection checking and validation

**ii. Shunt Reactor & Inter-connecting Transformer (ICT) Protection;**

- Whether two groups of protections used (Group A and Group B)
- Do the groups have separate DC sources
- Relay Make and Model
- List of all active protections along with settings
- Status of Differential Protection/Restricted Earth Fault Protection/Back-up Directional Overcurrent/Backup Earth fault/ Breaker Failure
- Status of Oil Temperature Indicator/Winding-Temperature Indicator/Bucholz/Pressure Release Device etc.
- Relay connected to Trip Coil-1 or 2 or both
- CT ratio and PT ratio
- Feed from DC supply-1 or 2
- Connected to dedicated CT core (mention name)
- Other requirements for protection checking and validation

**iii. Busbar Protection Relay;**

- Busbar and redundant relay make and model
- Type of Busbar arrangement
- Zones
- Dedicated CT core for each busbar protection (Yes/No)
- Breaker Failure relay included (Yes/No), if additional then furnish make and model
- Trip issued to both Busbar protection in case of enabling
- Isolator indication and check relays
- Other requirements for protection checking and validation

**iv. AC auxiliary system;**

- Source of AC auxiliary system
- Supply changeover between sources (Auto/Manual)
- Diesel generator (DG) details
- Maintenance plan and supply changeover periodicity in DG
- Single Line Diagram
- Other requirements for protection checking and validation

**v. DC auxiliary system;**

- Type of Batteries (Make, vintage, model)
- Status of battery Charger
- Measured voltage (positive to earth and negative to earth)
- Availability of ground fault detectors
- Protection relays and trip circuits with independent DC sources
- Other requirements for protection checking and validation
- Communication system
  - Mode of communication for Main-1 and Main-2 protection
  - Mode of communication for data and speech communication
  - Status of PLCC channels
  - Time synchronization equipment details
  - 7OPGW on geographically diversified paths for Main-1 and main-2 relay
  - Other requirements for protection checking and validation

**vi. Circuit Breaker Details;**

- Details and Status
- Healthiness of Tripping Coil and Trip circuit supervision relay
- Single Pole/Multi pole operation
- Pole Discrepancy Relay available (Y/N)
- Monitoring Devices for checking the dielectric medium
- Other requirements for protection checking and validation
- Current Transformer (CT)/Capacitive Voltage Transformer (CVT) Details
  - CT/CVT ID name and voltage level
  - CT/CVT core connection details
  - Accuracy Class

- Whether Protection/Metering
- CT/CVT ratio available and ratio adopted
- Details of last checking and validation of CT/CVT healthiness
- Other requirements for protection checking and validation
- Other protections: Direction earth fault, negative sequence, over current, over voltage, over frequency, under voltage, under frequency, forward power, reverse power, out of step/power swing, HVDC protection etc.

### 3. Summary of checking:

The summary shall specifically mention minimum following points:

- a) The settings and scheme adopted are in line with agreed protection philosophy or any accepted guidelines (e.g. Ramakrishna guidelines or CBIP manual based).
- b) The deviations from the RPC protection philosophy, if any and reasons for taking the deviations shall be recorded.
- c) All the major general deficiency shall be listed in detail along with remedial recommendations.
- d) The relay settings to be adopted shall be validated with simulation based or EMTP studies and details shall be enclosed in report.
- e) The cases of protection maloperation shall be analysed from protection indices report furnished by concerned utility, the causes of failure along with corrective actions and recommendations based on the findings shall be noted in the report.

## Annexure – 6: Protection Philosophy/Protocol of Northern Region

The Protection Philosophy/Protocol of Northern Region is developed in compliance of IEGC 2023, Version 2.0 which was approved in 71<sup>st</sup> NRPC meeting held on 29.01.2024.

S.N.	Protection Setting/Protocol	Mandated Setting for transmission lines
1	<b>Protection Scheme</b>	<p>220KV and above: Independent Main-I and Main-II protection (of different make OR different type/different algorithm) of non-switched numerical type is to be provided with carrier aided scheme.</p> <p>132KV and below: One non-switched distance protection scheme and, directional over current and earth fault relays, should be provided as back up.</p>
2	<b>Distance Protection Zone-1</b>	<p>Reach: 80% of the protected line; 110% of the protected line (In case of radial lines) Time Setting: Instantaneous.</p>
3	<b>Distance Protection Zone-2</b>	<p>Reach: Single Circuit Line: 120% of length of principle line section. Double circuit line: 150% coverage of line to take care of under reaching due to mutual coupling effect.</p> <p>Time setting: i. 0.35 second <i>(considering LBB time of 200mSec, CB open time of 60ms, resetting time of 30ms and safety margin of 60ms)</i> ii. 0.5-0.6 second <i>(For a long line followed by a short line)</i></p>

S.N.	Protection Setting/Protocol	Mandated Setting for transmission lines
4	<b>Distance Protection Zone-3</b>	Reach: Zone-3 should overreach the remote terminal of the longest adjacent line by an acceptable margin (typically 20% of highest impedance seen) for all fault conditions. Time Setting: 800-1000 msec If zone-3 reach transcends to other voltage level, time may be taken up to 1.5 sec.
5	<b>Distance Protection Zone- 4</b>	The Zone-4 reverse reach must adequately cover expected levels of apparent bus bar fault resistance. Time may be coordinated accordingly. Where Bus Bar protection is not available, time setting: 160 msec.
6	<b>Lines with Series and other compensations in the vicinity of Substation</b>	<ul style="list-style-type: none"> <li>• Zone-1:                FSC end: 60% of the protected line.                Time: Instantaneous;                Remoted end: 60% of the protected line with 100ms-time delay. POR Communication scheme logic is modified such that relay trips instantaneously in Zone-1 on carrier receive.</li> <li>• Zone-2:                120 % of uncompensated line impedance for single circuit line. For Double circuit line, settings may be decided on basis of dynamic study in view of zero sequence mutual coupling.</li> <li>• Phase locked voltage memory is used to cope with the voltage inversion. Alternatively, an intentional time delay may be applied to overcome directionality problems related to voltage inversion.</li> <li>• Over-voltage stage-I setting for series compensated double circuit lines may be kept higher at 113%.</li> </ul>

S.N.	Protection Setting/Protocol	Mandated Setting for transmission lines
7	<b>Power Swing Blocking</b>	<ul style="list-style-type: none"> <li>• Block tripping in all zones, all lines.</li> </ul> Out of Step tripping to be applied on all inter-regional tie lines. Deblock time delay = 2s
8	<b>Protection for broken conductor</b>	Negative Sequence current to Positive Sequence current ratio more than 0.2 (i.e. $I_2/I_1 \geq 0.2$ ) Alarm Time delay: 3-20 sec. Tripping may be considered for radial lines to protect single phasing of transformers.
9	<b>Switch on to fault (SOTF)</b>	Switch on to fault (SOTF) function to be provided in distance relay to take care of line energization on fault.
10	<b>VT fuse fail detection function</b>	VT fuse fail detection function shall be correctly set to block the distance function operation on VT fuse failure.
11	<b>Carrier Protection</b>	To be applied on all 220KV and above lines with the only exception of radial feeders.
12	<b>Back up Protection</b>	<ol style="list-style-type: none"> <li>1. On 220KV and above lines with 2 Main Protections:               <ul style="list-style-type: none"> <li>• Back up Earth Fault protections alone to be provided.</li> <li>• No Over current protection to be applied.</li> </ul> </li> <li>2. At 132KV and below lines with only one Main protection:               <ul style="list-style-type: none"> <li>• Back up protection by IDMT O/C and E/F to be applied.</li> </ul> </li> </ol>



S.N.	Protection Setting/Protocol	Mandated Setting for transmission lines
13	<b>Auto Reclosing with dead time.</b>	<p>AR shall be enabled for 220 KV and above lines for single pole trip and re-closing. Dead time = 1.0s. Reclaim time = 25.0s</p> <p>Auto-recloser shall be blocked for following:</p> <ul style="list-style-type: none"> <li>• Faults in cables</li> <li>• Breaker Fail Relay</li> <li>• Line Reactor Protections</li> <li>• O/V Protection</li> <li>• Received Direct Transfer trip signals</li> <li>• Busbar Protection</li> <li>• Zone 2/3 of Distance Protection</li> <li>• Circuit Breaker Problems.</li> </ul> <p>CB Pole discrepancy relay time:1.5 sec; for tie breaker: 2.5 sec</p>
14	<b>Busbar protection</b>	To be applied on all 220KV and above sub stations with the only exception of 220KV radial fed bus bars.
15	<b>Local Breaker Backup (LBB)</b>	<p>For 220 KV and above level substations as well as generating stations switchyards, LBB shall be provided for each circuit breaker.</p> <p>LBB Current sensor <math>I &gt; 20\%</math> In LBB time delay = 200ms</p> <p>In case of variation in CT ratio, setting may be done accordingly.</p>
16	<b>Line Differential</b>	<p>For cables and composite lines, line differential protection with built in distance back up shall be applied as Main-I protection and distance relay as Main-II protection.</p> <p>For very short line (less than 10 km), line differential protection with distance protection as</p>

S.N.	Protection Setting/Protocol	Mandated Setting for transmission lines
		<p>backup (built- in Main relay or standalone) shall be provided mandatorily as Main-I and Main-II.</p> <p>Differential protection may be done using dark fiber (preferably), or using bandwidth.</p>
17	Over Voltage Protection	<p>FOR 765KV LINES/CABLE:  Low set stage (Stage-I): 106% - 109% (typically 108%) with a time delay of 5 seconds.  High set stage (Stage-II): 140% - 150% with a time delay of 100 milliseconds.</p> <p>400KV LINES/CABLE:  Low set stage (Stage-I): 110% - 112% (typically 110%) with a time delay of 5 seconds.  High set stage (Stage-II): 140% - 150% with a time delay of 100 milliseconds.</p> <p>FOR 220 KV LINES:  No over-voltage protection shall be used.</p> <p>FOR 220 KV CABLE:  Low set stage (Stage-I): 110% - 112% (typically 110%) with a time delay of 5 seconds.  High set stage (Stage-II): 140% - 150% with a time delay of 100 milliseconds.</p> <p>Drop-off to pick-up ratio of overvoltage relay:  better than 97%</p> <p>Grading: Voltage as well as time grading may be done for multi circuit lines/cable.</p>

S.N.	Protection Setting/Protocol	Mandated Setting for transmission lines
18	<b>Resistive reach setting to prevent load point encroachment</b>	<p>Following criteria may be considered for deciding load point encroachment:</p> <ul style="list-style-type: none"> <li>• Maximum load current (<math>I_{max}</math>) may be considered as 1.5 times the thermal rating of the line or 1.5 times the associated bay equipment current rating (the minimum of the bay equipment individual rating) whichever is lower. (Caution: The rating considered is approximately 15minutes rating of the transmission facility).</li> <li>• Minimum voltage (<math>V_{min}</math>) to be considered as 0.85pu (85%).</li> </ul>
19	<b>Direct Inter-trip</b>	<p>To be sent on operation of following:</p> <ol style="list-style-type: none"> <li>i. Overvoltage Protection</li> <li>ii. LBB Protection</li> <li>iii. Busbar Protection</li> <li>iv. Reactor Protection</li> <li>v. Manual Trip (400 KV and above)</li> <li>vi. Cable Fault (in composite lines)</li> </ol>
20	<b>Permissive Inter-trip</b>	To be sent on operation of Distance Protection

## Annexure – 7: Work Order & Corrigendum



पावर ट्रांसमिशन कारपोरेशन ऑफ उत्तराखण्ड लि0  
(उत्तराखण्ड सरकार का उपक्रम)  
अधीक्षण अभियन्ता (परीक्षण एवं परिचालन एवं स्काडा) कार्यालय  
कुमायु मण्डल हल्द्वानी  
मोबाइल नं0 9412089275, ईमेल dp\_singh@ptcul.org

No. 376 /SE (T&C)/PTCUL/ (H)/

Date:29.09.2023

Subject:- Order for Protection Audit of 02 Nos 400 kV and 08 Nos 220KV sub-stations in PTCUL.

Joint Advisor

Central Board of Irrigation and Power

Malcha Marg Chanakyapuri,

New Delhi-110021

Email: mrchauhan@cbip.org.

Dear Sir,

In reference to your offer submitted vide Ref No: P-1/CBIP/PTCUL/PTCUL/Audit/2023 dated: 11.09.2023 through email against Email enquiry dated 05.09.2023, an order is hereby placed in favour of your firm for the work of "Protection Audit of 02 Nos 400kV and 08 Nos 220 kV substations of PTCUL" The detail of material, price schedule and terms & conditions is here as under:-

Sr.No	Description	Unit	Qty	Amount	Total Amount
1	Protection Audit to be carried out for the following 10 nos of the 400/220kV substations of PTCUL :- 1. 400kV S/s Rishikesh 2. 400 kV S/s Kashipur 3. 220kV S/s Chamba 4. 220kV S/s Rishikesh 5. 220kV S/s Roorkee 6. 220kV S/s Haridwar (SIDCUL) 7. 220kV S/s Jhajra. 8. 220 kV S/s Pantnagar. 9. 220 kV S/s Haldwani. 10. 220kV S/s Mahuakheraganj.	Job	1	36,25,000	36,25,000
	TOTAL				36,25,000

Total value of order is Rs.36,25,000 (Rupees Thirty Six Lakh Twenty Five Thousand only ) Plus GST Extra.

End: 1. Terms & Conditions.

Please acknowledge the receipt and acceptance of order.

(D.P Singh)

Superintending Engineer (T&C), Haldwani

No.376 /SE (T&C)/PTCUL/ (H)/

Date:29.09.2023

Copy forwarded to the following for information and necessary action:-

1. Director (Operation), PTCUL, Dehradun.
2. Superintending Engineer (A) MD, PTCUL, Dehradun.
3. Chief Engineer, T&C PTCUL, 132kV Substation Campus, Kathgodam Nainital.
4. Executive Engineer, T&C Division, Kashipur.
5. Director (Energy), Central Board of Irrigation and Power Malcha Marg Chanakyapuri, New Delhi-110021 Email: [sanjeev@cbip.org](mailto:sanjeev@cbip.org)

(D.P Singh)

Superintending Engineer (T&C), Haldwani

मुख्यालय एवंपंजीकृत कार्यालय:-विद्युतमवन, नजदीक-आई0एस0बी0टी0 क्रासिंग, सहारनपुररोड, माजरा, देहरादून-248002  
कारपोरेटआईडी नं0: U40101UR2004GOI028675 दूरभाष नं0 0135-2646000 फैक्स नं0 0135-2643460 वेबसाइट-[www.ptcul.org](http://www.ptcul.org)



पावर ट्रांसमिशन कारपोरेशन ऑफ उत्तराखण्ड लि०  
(उत्तराखण्ड सरकार का उपक्रम)  
अधीक्षण अभियन्ता (परीक्षण एवं परिचालन एवं स्काडा) कार्यालय  
कुमायु मण्डल हल्द्वानी  
मोबाइल नं० 9412089275, ईमेल dp\_singh@ptcul.org

Terms & Conditions:-

1	Scope	: The detailed Scope work is as under: <ol style="list-style-type: none"><li>1. There must be a kick off meeting for discussion on project plan before start of the work in field and the detailed plan of performance shall be submitted by CBIP.</li><li>2. Requisite data shall be collected in standard format from PTCUL grid substations by authorized and experienced auditor.</li><li>3. The site surveys and audit of grid substations of PTCUL shall be done by authorized and experienced auditor.</li><li>4. Review of the implemented protection schemes/philosophy for 400/220 kV substations which includes protection of transmission lines,interconnecting transformers, line/busreactors, bus bar, bus couplers etc.as per latest guidelines of Ramakrishna committee/CBIP/NRPC/Intenational best practices,etc.</li><li>5. Review the adequacy of primary and backup protection settings for protected equipment and suggest corrective measures where evernon compliance with respect to Ramakrishna committee/ CBIP/NRPC is found during the protection audit.</li><li>6. Review of availability/healthiness of PLCC communication links used for protection systems.</li><li>7. Review the healthiness/adequacy of 220/110/50V DC system available at substations for protection application.</li><li>8. Review of availability/healthiness of GPS system and time synchronization facility used for protection.</li><li>9. Review of availability/healthiness of recording instruments like DRs /ELs for transmission lines protection.</li><li>10. Review of test reports for assessing the healthiness of circuit breakers, CT &amp; CVT based upon available test reports at sites.</li><li>11. Field inspection of protection device for obsolescence of technology, suitability and healthiness.</li><li>12. Directory of the protection system &amp; recommendation for replacement of obsolescence relays with compatible numerical relays will be provided.</li><li>13. Checking of availability of DGset/auxiliary DC supply at substations.</li><li>14. Site visits for onsite protection audit, review and inspection of substations will be performed.</li><li>15. Submission of the detailed report for the protection audit including the protection philosophy, reviewed settings and protection audit observations.</li><li>16. The performance of above protection equipment like relays, circuit breaker, CT, CVT, DC battery bank, synchro facility, communication facility used for protection will be also checked through physical inspection and provided test reports/documents. These protection equipments will be recommended for renovation and upgradation based on their performance accessed during protection audit and physical inspection.</li><li>17. Review the availability healthiness of<ul style="list-style-type: none"><li>• Event recorders/ loggers' operation history</li><li>• CT, CVT, CB</li><li>• DC power supply</li><li>• Auxiliary supply</li><li>• Communication links</li><li>• Time synchronization/ GPS</li></ul></li><li>18. Review of Testing and Maintenance records of all protective relays, Circuit Breakers CT, CVT etc. Review of protection philosophy.</li></ol>
---	-------	---

मुख्यालय एवंपजीकृत कार्यालय:-विद्युतमवन, नजदीक-आई०एस०बी०टी० क्रासिंग, सहारनपुररोड, माजरा, देहरादून-248002  
कारपोरेटआईडी नं०: U40101UR2004GOI028675 दूरभाष नं० 0135-2646000 फ़ैक्स नं० 0135-2643460 वेबसाइटwww.ptcul.org





**पावर ट्रांसमिशन कारपोरेशन ऑफ उत्तराखण्ड लि०**  
(उत्तराखण्ड सरकार का उपक्रम)  
**अधीक्षण अभियन्ता (परीक्षण एवं परिचालन एवं स्काडा) कार्यालय**  
**कुमायु मण्डल हल्द्वानी**  
मोबाइल नं० 9412089275, ईमेल dp\_singh@ptcul.org

			19. Anything which is left to be mentioned here but required for successful completion of the aforementioned subject work shall be done <b>Central Board of Irrigation and Power Malcha Marg Chanakyapuri, New Delhi-110021</b>
			20. CBIP Delhi shall submit a report on detailed points in four sets of hard copy duly spiraled binding as well as soft copy shall be submitted.
			21. The safety guidelines prevalent in PTCUL must be followed.
2	GST	:	GST shall be paid extra as per applicable Government rules.
3	Tax	:	Tax shall be deducted at source as per applicable Government rules. A certificate to this effect may be given to the Contractor if required.
4	Date of Start of work	:	Order shall be considered as having come in to force from the date of issue of order.
5	Supply Completion	:	NA
6	Work completion	:	The work should be completed within 24 months from the date of issue of order.
7	Engineer of the contract		Superintending Engineer (T&C), Haldwani is the "Engineer of the contract" who shall be placing the order for the work with the contractor and signing the contract agreement and who has been inherently vested with such powers by corporation in this behalf and shall act as Engineer for the purpose of the contract.
8	Engineer in-charge		<b>Respective Executive Engineer (T&amp;C) shall be "Engineer in charge"</b> for the subject work.
9	Liquidity damages	:	If the contract is delayed beyond the stipulated period mentioned in the contract. The liquidity damages shall be levied @ 0.5 % per week and maximum up to 10% of contract value.
10	Dispute		All Dispute arising out of this case under the jurisdiction local court at Kashipur and Honable High Court, Nainital.
11	Payment terms	:	<ol style="list-style-type: none"><li>25% Payment will be made within 30 days after finalization of Audit plan, subject to availability of funds from PTCUL HQ.</li><li>35% Payment will be made within 30 days after submission of preliminary reports verified by Executive Engineer of respective division, subject to availability of funds from PTCUL HQ.</li><li>40 % Payment will be made within 30 days after submission of final reports verified by Executive Engineer of respective division, subject to availability of funds from PTCUL HQ.</li></ol>
12	Payment unit		Test & Commissioning Division, Kashipur shall be the payment unit and all units where is to be work done shall record the measurement and duly passed bills along with measurement book shall be submitted to payment unit.
13	Warranty period	:	NA.
14	Billing Address	:	Executive Engineer Test & Commissioning Division, PTCUL 400 KV Substation Campus, Kashipur (Uttarakhand)-244713, GSTIN No. (05AAECM1785FCZ9)

All other term and condition of this order shall be governed by the General conditions of the contract prevalent in PTCUL.

  
(D.P. Singh)

Superintending Engineer(T&C), Haldwani

मुख्यालय एवंपंजीकृत कार्यालय:-विद्युतमवन, नजदीक-आई०एस०बी०टी० क्रासिंग, सहारनपुररोड, गाजरा, देहरादून-248002  
कारपोरेटआईडी नं०: U40101UR2004GOI028675 दूरभाष नं० 0135-2646000 फैक्स नं० 0135-2643460 वेबसाइटwww.ptcul.org



पावर ट्रांसमिशन कारपोरेशन ऑफ उत्तराखण्ड लि०  
(उत्तराखण्ड सरकार का उपक्रम)  
अधीक्षण अभियन्ता (परीक्षण एवं परिचालन एवं स्काडा) कार्यालय  
कुमायु मण्डल हल्द्वानी  
मोबाइल नं० 9412089275, ईमेल dp\_singh@ptcul.org

No. 394 /SE (T&C)/PTCUL/ (H)/

Date:26.10.2023

Subject:- Corrigendum for the Order for the work of Protection Audit of 02 Nos 400 kV and 08 Nos 220KV sub-stations in

PTCUL

Joint Advisor

Central Board of Irrigation and Power

Malcha Marg Chanakyapuri,

New Delhi-110021

Email: mrchauhan@cbip.org.

Dear Sir,

In reference to above mentioned subject, please refer to kick off meeting held on dated 26.10.2023 for the work of Protection Audit of 02 Nos 400 kV and 08 Nos 220KV sub-stations in PTCUL against order no.376 dated 29.09.2023.

In this regard, kindly find enclosed herewith corrigendum of order no.376 dated 29.09.2023 (Annexure-1) with necessary amendments as discussed in afforementioned meeting.

This is for your kind information and necessary action.

Please acknowledge the receipt and acceptance of order.

(D.P Singh)

Superintending Engineer (T&C), Haldwani

Copy forwarded to the following for information and necessary action:-

1. Chief Engineer, T&C PTCUL, 132kV Substation Campus, Kathgodam Nainital..
2. Executive Engineer, T&C Division, Roorkee/Dehradun/Haldwani/Kashipur/Rishikesh with request to provide assistance and information to CBIP for the above work.
3. Director (Energy), Central Board of Irrigation and Power Malcha Marg Chanakyapuri, New Delhi-110021  
Email: [sanjeev@cbip.org](mailto:sanjeev@cbip.org)

मुख्यालय एवंपंजीकृत कार्यालय:-विद्युतमवन, नजदीक-आई०एस०बी०टी० क्रॉसिंग, सहारनपुररोड, माजरा, देहरादून-248002  
कारपोरेटआईडी नं०: U40101UR2004GOI028675 दरमाश नं० 0135-2646000 फॅक्स नं० 0135-2643460 वेबसाइट[www.ptcul.org](http://www.ptcul.org)

**Annexure -1 – Work order corrigendum**

Scope: The detailed Scope work is as under:

S. No.	Clause of PO	Existing Clause					Modified Clause						
		Sr. No	Description	Unit	Qty	Amount	Total Amount	Sr. No	Description	Unit	Qty	Unit rate (Rs.)	Total Amount (Rs.)
1	Price Schedule	1	Protection Audit to be carried out for the following 10 nos. of the 400/220kV substations of PTCUL :- 1. 400kV S/s Rishikesh 2. 400 kV S/s Kashipur 3. 220kV S/s Chamba 4. 220kV S/s Rishikesh 5. 220kV S/s Roorkee 6. 220kV S/s Haridwar (SIDCUL) 7. 220kV S/s Jhajra 8. 220 kV S/s Pantnagar. 9. 220 kV S/s Haldwani. 10. 220kV S/s Mahuaakheraganj. TOTAL	Job	1	36,25,000	36,25,000	1	Protection Audit to be carried out for the following 10 nos of the 400/220kV substations of PTCUL :- 1. 400kV S/s Rishikesh 2. 400 kV S/s Kashipur 3. 220kV S/s Chamba 4. 220kV S/s Rishikesh 5. 220kV S/s Roorkee 6. 220kV S/s Haridwar (SIDCUL) 7. 220kV S/s Jhajra 8. 220 kV S/s Pantnagar 9. 220 kV S/s Haldwani 10. 220kV S/s Mahuaakheraganj. TOTAL	Each	10	3,62,500	36,25,000
2	Terms and Conditions S. No. 1 – Scope	1	There must be a kick off meeting for discussion on project plan before start of the work in field and the detailed plan of performance shall be submitted by CBIP.					1	There must be a kick off meeting for discussion on project plan before start of the work in field and the detailed plan of performance shall be submitted by CBIP.				
		2	Requisite data shall be collected in standard format from PTCUL grid substations by authorized and experienced auditor.					2	Requisite data shall be collected in standard format from PTCUL grid substations by an experienced auditor.				
		3	The site surveys and audit of grid substations of PTCUL shall be done by authorized and experienced auditor.					3	The site surveys and audit of grid substations of PTCUL shall be done by an experienced auditor.				
		4	Review of the implemented protection schemes/ philosophy for 400/220 kV substations which includes protection of transmission lines, interconnecting transformers, line/bus reactors, bus bar, bus					4	Review of the implemented protection schemes/philosophy for 400/220 kV substations which includes protection of transmission lines, interconnecting transformers, line/bus reactors, bus bar, bus couplers etc with respect to				





S. No.	Clause of PO	Existing Clause	Modified Clause
		couplers etc.as per latest guidelines of Ramakrishna committee/ CBIP/NRPC/international best practices. etc.	tripping in last one year as per latest guidelines of Ramakrishna committee/ CBIP/NRPC/international best practices, which includes review of the following:
5.	Review the adequacy of primary and backup protection settings for protected equipment and suggest corrective measures where everyone compliance with respect to Ramakrishna committee/ CBIP/NRPC is found during the protection audit.	Review the healthiness/adequacy of 220/110/50V DC system available at substations for protection application.	a) Adequacy of primary and backup protection settings for protected equipment and suggest corrective measures
6.	Review of availability/healthiness of PLCC communication links used for protection systems.	Review of availability/healthiness of GPS system and time synchronization facility used for protection.	b) Availability/healthiness of PLCC communication links used for protection systems.
7.	Review of availability/healthiness of recording instruments like DRs /ELs for transmission lines protection.	Review of test reports for assessing the healthiness of circuit breakers, CT & CVT based upon available test reports at sites.	c) Healthiness/adequacy of 220/110/50V DC system available at substations for protection application.
8.	Review of availability/healthiness of recording instruments like DRs /ELs for transmission lines protection.	Field inspection of protection device for obsolescence of technology, suitability and healthiness.	d) Availability/healthiness of GPS system and time synchronization facility used for protection.
9.	Review of test reports for assessing the healthiness of circuit breakers, CT & CVT based upon available test reports at sites.	Prepare recommendation for replacement of obsolescence relays with compatible numerical relays will be provided.	e) Availability/healthiness of recording instruments like DRs /ELs for transmission lines protection.
10.	Field inspection of protection device for obsolescence of technology, suitability and healthiness.	Checking of availability of DG Set/auxiliary DC supply at substations.	f) Test reports for assessing the healthiness of circuit breakers, CT & CVT based upon available test reports at sites.
11.	Field inspection of protection device for obsolescence of technology, suitability and healthiness.	Site visits for onsite protection audit, review and inspection of substations will be performed.	g) Field inspection of protection device for obsolescence of technology, suitability and healthiness.
12.	Directory of the protection system & recommendation for replacement of obsolescence relays with compatible numerical relays will be provided.	Submission of the detailed report for the protection audit including the protection philosophy, reviewed settings and protection audit observations.	h) Prepare recommendation for replacement of obsolescence relays with compatible numerical relays will be provided.
13.	Checking of availability of DG Set/auxiliary DC supply at substations.	The performance of above protection equipment like relays, circuit breaker, CT, CVT, DC battery bank, synchro facility, communication facility used for protection will be also checked through physical inspection and provided test reports/documents. These protection equipment's will be recommended for renovation and upgradation based on their performance accessed during protection audit and physical inspection.	i) Checking of availability of DG Set / auxiliary DC supply at substations.
14.	Site visits for onsite protection audit, review and inspection of substations will be performed.		5. Site visits for onsite protection audit, review and inspection of substations will be performed
15.	Submission of the detailed report for the protection audit including the protection philosophy, reviewed settings and protection audit observations.		6. Submission of the detailed report for the protection audit including the protection philosophy, reviewed settings and protection audit observations.
16.	The performance of above protection equipment like relays, circuit breaker, CT, CVT, DC battery bank, synchro facility, communication facility used for protection will be also checked through physical inspection and provided test reports/documents. These protection equipment's will be recommended for renovation and upgradation based on their performance accessed during protection audit and physical inspection.		Deleted as it is covered in point 4 above.







5. Clause of PO	Existing Clause	Modified Clause
	<p>17. Review the availability healthiness of</p> <ul style="list-style-type: none"> <li>• Event recorders/ loggers' operation history</li> <li>• CT, CVT, CB</li> <li>• DC power supply</li> <li>• Auxiliary supply</li> <li>• Communication links</li> <li>• Time synchronization/ GPS</li> </ul> <p>18. Review of Testing and Maintenance records of all protective relays, Circuit Breakers CT, CVT etc. Review of protection philosophy.</p> <p>19. Anything which is left to be mentioned here but required for successful completion of the aforementioned subject work shall be done Central Board of Irrigation and Power Malcha Marg Chanakyapuri, New Delhi-110021</p> <p>20. CBIP Delhi shall submit a report on detailed points in four sets of hard copy duly spiraled binding as well as soft copy shall be submitted.</p> <p>21. The safety guidelines prevalent in PTCUL must be followed.</p>	<p>7. Anything which is left to be mentioned here but required for successful completion of the aforementioned subject work shall be done by Central Board of Irrigation and Power.</p> <p>8. CBIP Delhi shall submit a protection report on detailed points in four sets of hard copy duly spiraled binding and in soft copy as well.</p> <p>9. The safety guidelines prevalent in PTCUL must be followed.</p>
3	<p>Terms and Conditions</p> <p>S. No. 6 - Work Completion</p>	<p>The work should be completed within 24 weeks from the date of issue of corrigendum.</p>
4	<p>Terms and Conditions</p> <p>S. No. 8 - Engineer-in-charge</p>	<p>The following Executive Engineers (T&amp;C) shall be "Engineer in charge" for the subject work:</p> <p>a) 400KV Rishikesh, 220KV Rishikesh, 220 kV Chamba – Mr. Harsh Verma (Ph. No.9412074038 &amp; Email: ee_tandc_rsh@ptcul.org).</p> <p>b) 400KV Kashipur, 220KV Pantnagar, 220KV Haldwani &amp; 220KV Mahuakheraganj – Mr. Asim Baig (Ph. No. 9412087885 &amp; Email: ee_tandc_ksp@ptcul.org).</p> <p>c) 220KV SIDCUL Haridwar, 220 kV Roorkee – Mr. Ashwini Kumar (Ph. No.7088117301 &amp; Email: ee_tandc_rke@ptcul.org).</p> <p>d) 220KV Jhajra – Mr. Ravindra Kumar (Ph. No. 9927744222 &amp; Email: ee_tandc_ddun@ptcul.org).</p>





S. No.	Clause of PO	Existing Clause	Modified Clause
5	Terms and Conditions - S. No. 11 - Payment Terms	<ol style="list-style-type: none"> <li>25% Payment will be made within 30 days after finalization of Audit plan, subject to availability of funds from PTCUL HQ.</li> <li>35% Payment will be made within 30 days after submission of preliminary reports verified by Executive Engineer of respective division, subject to availability of funds from PTCUL HQ.</li> <li>40 % Payment will be made within 30 days after submission of final reports verified by Executive Engineer of respective division, subject to availability of funds from PTCUL HQ.</li> </ol>	<ol style="list-style-type: none"> <li>25% Payment will be made within 30 days after finalization of Audit plan, subject to availability of funds from PTCUL HQ.</li> <li>35% Payment will be made within 30 days after submission of preliminary reports <b>on prorata basis</b> verified by Executive Engineer of respective division, subject to availability of funds from PTCUL HQ.</li> <li>40 % Payment will be made within 30 days after submission of final reports <b>on prorata basis</b> verified by Executive Engineer of respective division, subject to availability of funds from PTCUL HQ.</li> <li>The local travel, lodging &amp; boarding shall be arranged by PTCUL on free-of-cost basis for CBIP team visiting the substation</li> </ol>







## **Annexure – 8: Data Sheets**

# Contents

<b>Single Line Diagrams</b> .....	62
<i>Substation Single Line Diagram</i> .....	62
<i>AC Auxiliary System</i> .....	63
<i>SAS Architecture diagram</i> .....	64
<b>Transmission Lines</b> .....	65
<b>Bus-Bar Protection</b> .....	71
<b>AC Auxiliary System</b> .....	72
<b>DC Auxiliary System</b> .....	73
<b>Circuit Breakers</b> .....	74
<b>Current Transformer</b> .....	75
<b>Capacitive Voltage Transformer/Potential Transformer</b> .....	78
<b>Disturbance Recorder (DR) &amp; Event Logger (EL)</b> .....	81
<b>Communication System</b> .....	82
<b>Transformer Protection</b> .....	83
<b>Special Protection Scheme (SPS)</b> .....	86
<b>Network Diagram of Uttarakhand</b> .....	92
<b>Power Map of Uttarakhand</b> .....	93



## Protection Audit of 220/132/33kV Pantnagar Substation

### Annexure - 8

#### Data Sheets

## Single Line Diagrams

### *Substation Single Line Diagram*

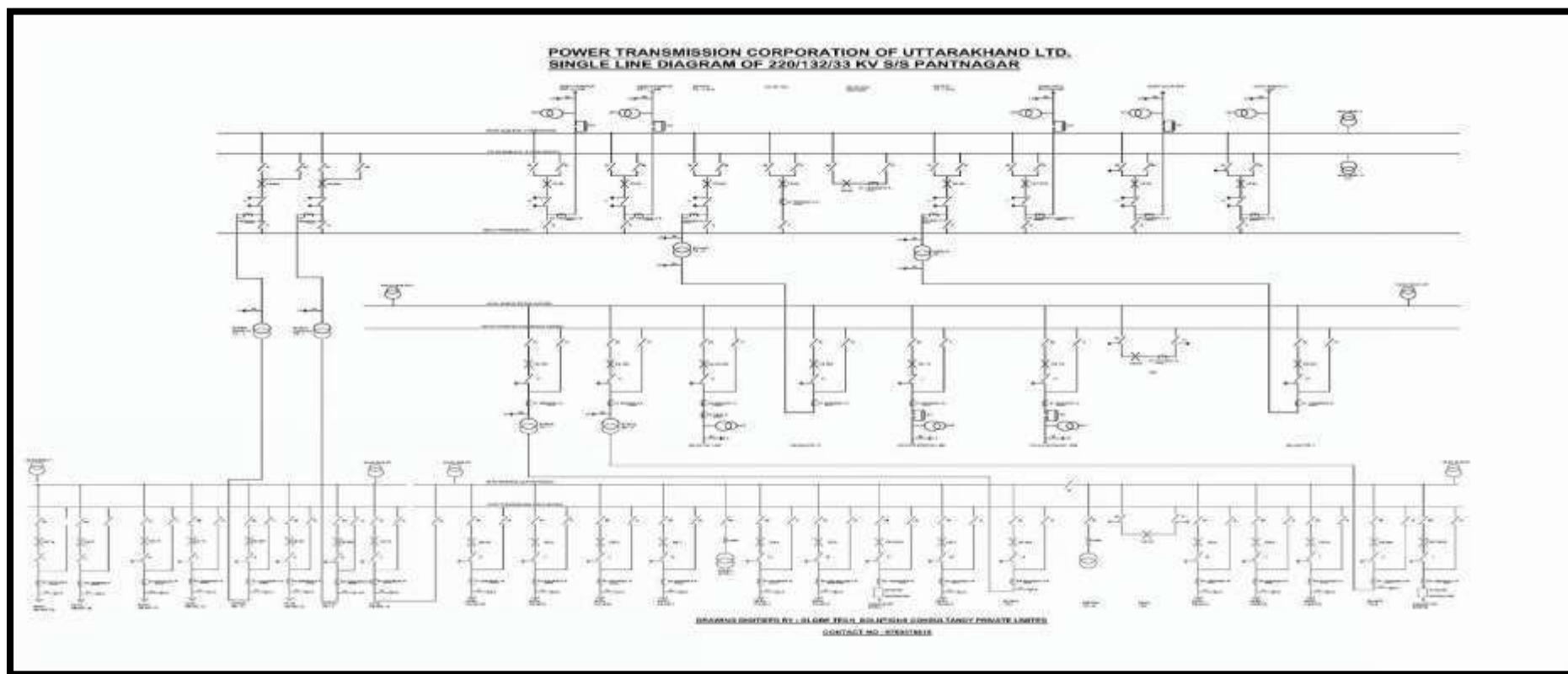

AC Auxiliary System

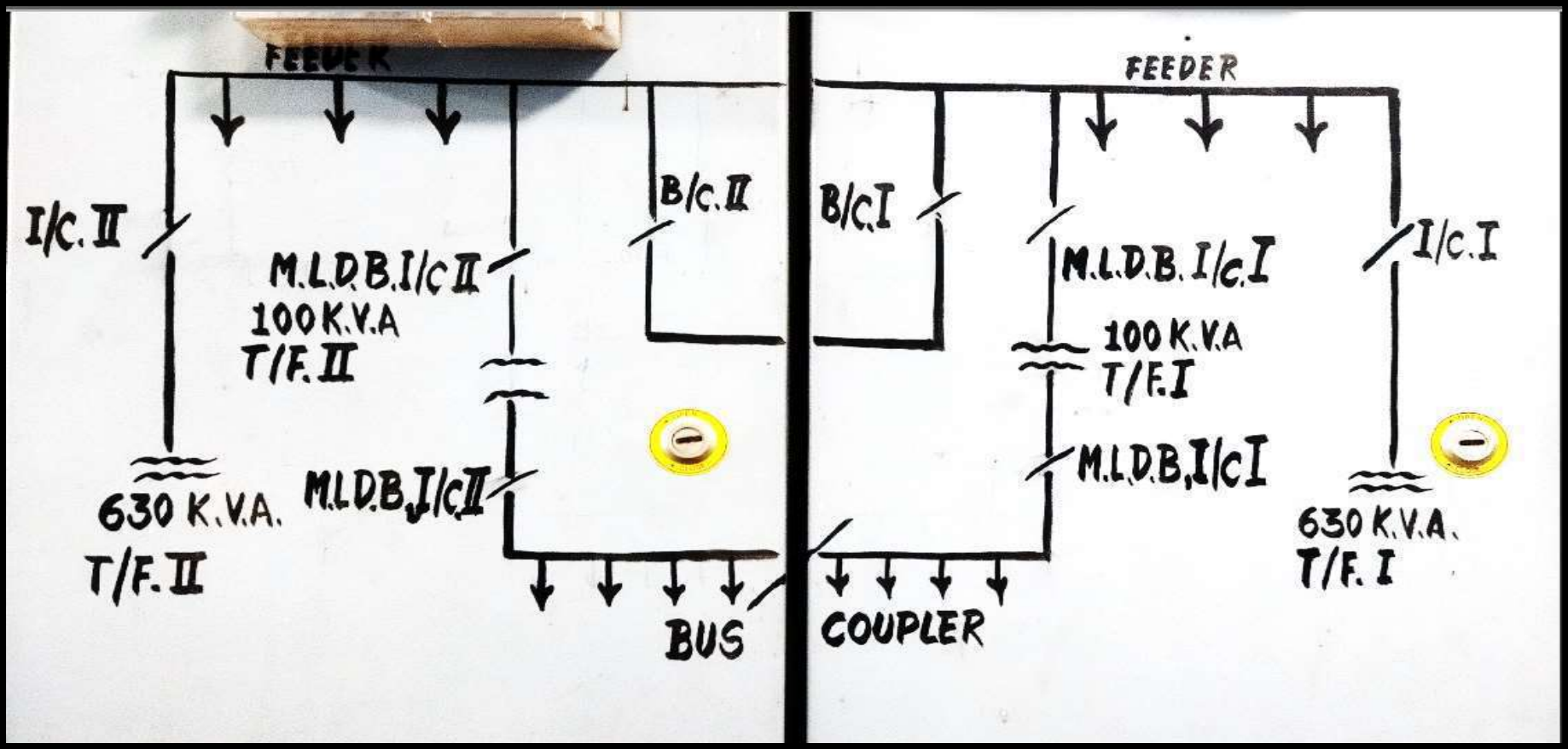

# SAS Architecture diagram

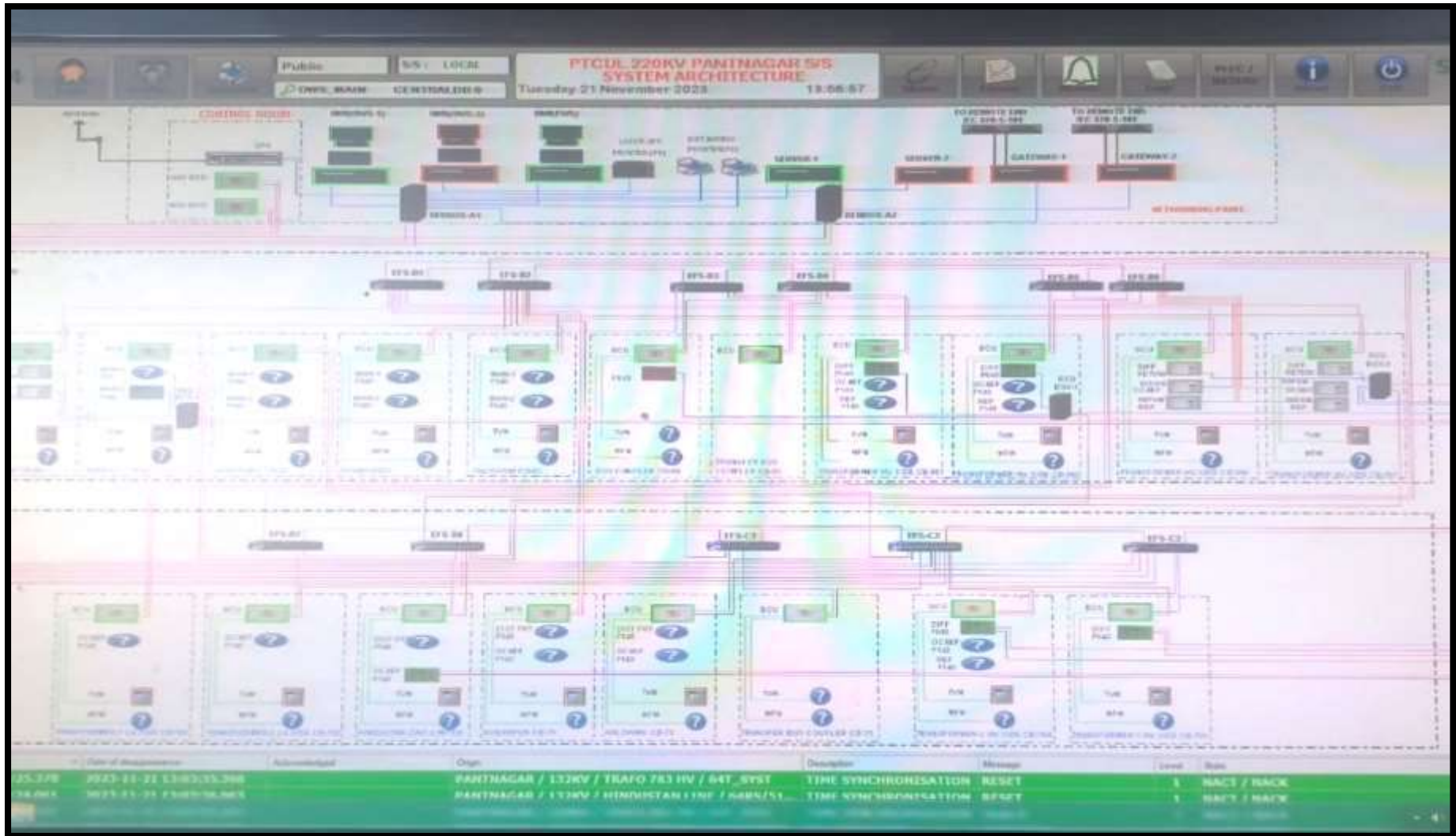



## Transmission Lines

	Tr Line 1	Tr Line 2	Tr Line 3	Tr Line 4	Tr Line 5
<b>Name of Tr Line</b>	220KV Bareilly line	220KV Jafarpur line	220KV TATA line	220KV Kashipur line	220KV Haldwani line
<b>Length of Line</b>	70.70km	16.65km	1.710km	64.6km	37.32km
<b>Series Compensated (Yes/No)</b>	NO	NO	NO	NO	NO
<b>Connected to dedicated CT core (mention name)</b>	CORE-1 for main-1, CORE-2 for main-2, CORE-3 for metering, CORE-4 for busbar protection, CORE-5 SPARE.	CORE-1 for main-1, CORE-2 for main-2, CORE-3 for metering, CORE-4 for busbar protection, CORE-5 SPARE.	CORE-1 for main-1, CORE-2 for main-2, CORE-3 for metering, CORE-4 for busbar protection, CORE-5 SPARE.	CORE-1 for main-1, CORE-2 for main-2, CORE-3 for metering, CORE-4 for busbar protection, CORE-5 SPARE.	CORE-1 for main-1, CORE-2 for main-2, CORE-3 for metering, CORE-4 for busbar protection, CORE-5 SPARE.
<b>CT Ratio</b>	1600:1	800:1	400:1	1600:1	1600:1
<b>Connected to dedicated PT core (mention name)</b>	CORE-1 for main-1, CORE-2 for main-2, CORE-3 for metering.	CORE-1 for main-1, CORE-2 for main-2, CORE-3 for metering.	CORE-1 for main-1, CORE-2 for main-2, CORE-3 for metering.	CORE-1 for main-1, CORE-2 for main-2, CORE-3 for metering.	CORE-1 for main-1, CORE-2 for main-2, CORE-3 for metering.
<b>PT Ratio</b>	220KV:110v	220KV:110v	220KV:110v	220KV:110v	220KV:110v
<b>Relay connected to Trip Coil-1 or 2 or both</b>	Both	Both	Both	Both	Both
<b>Feed from DC supply-1 or 2</b>	Both	Both	Both	Both	Both
<b>i</b> Main-I Protection (Make and	Siemens SIPROTEC7SA52	Siemens SIPROTEC7SA52	MICOM P442	ABB REL650	MICOM P442

		Tr Line 1	Tr Line 2	Tr Line 3	Tr Line 4	Tr Line 5
	Model)					
	Functional (Yes/No)	Yes	Yes	Yes	Yes	Yes
	Date of testing	NA	NA	NA	NA	NA
ii	Main-II Protection (Make and Model)	MICOM P442	MICOM P442	MICOM P442	ABB REL650	MICOM P442
	Functional (Yes/No)	Yes	Yes	Yes	Yes	Yes
	Date of testing	NA	NA	NA	NA	NA
iii	LBB Protection (Make and Model)	MiCOM Areva P821	MiCOM Areva P821	MiCOM Areva P821	MiCOM Areva P821	MiCOM Areva P821
	Functional (Yes/No)	NO	NO	NO	NO	NO
	Date of testing	NA	NA	NA	NA	NA
iv	PLCC/ Protection coupler (Make and Model)	NA	NA	NA	NA	NA
	Functional (Yes/No)	NA	NA	NA	NA	NA
v	DR (Make & Model) (Make and Model)	NA	NA	NA	NA	NA
	Functional (Yes/No)	NA	NA	NA	NA	NA

		Tr Line 1	Tr Line 2	Tr Line 3	Tr Line 4	Tr Line 5
vi	Time Synch. Unit (Make and Model)	SANDS	SANDS	SANDS	SANDS	SANDS
	Functional (Yes/No)	YES	YES	YES	YES	YES
<b>Other Protections</b>						
1	Status of Power Swing	ENABLE	ENABLE	ENABLE	ENABLE	ENABLE
2	Out of Step	1	1	1	1	1
3	SOTF	ENABLE	ENABLE	ENABLE	ENABLE	ENABLE
4	Breaker Failure	ENABLE	ENABLE	ENABLE	ENABLE	ENABLE
5	Broken Conductor	ENABLE	ENABLE	ENABLE	ENABLE	ENABLE
6	STUB	ENABLE	ENABLE	ENABLE	ENABLE	ENABLE
7	Fault Locator	ENABLE	ENABLE	ENABLE	ENABLE	ENABLE
8	Disturbance Recorder	VISIBLE	VISIBLE	VISIBLE	VISIBLE	VISIBLE
9	VT fuse fail	ENABLE	ENABLE	ENABLE	ENABLE	ENABLE
10	Overvoltage Protection	ENABLE	ENABLE	ENABLE	ENABLE	ENABLE
11	Trip Circuit supervision	ENABLE	ENABLE	ENABLE	ENABLE	ENABLE
12	Auto-reclose	ENABLE	ENABLE	ENABLE	ENABLE	ENABLE
13	Load encroachment	-	-	-	-	-

**132KV:**

	<b>Tr Line 1</b>	<b>Tr Line 2</b>	<b>Tr Line 3</b>
<b>Name of Tr Line</b>	132KV Haldwani line	132KV Rudrapur line	132KV HZL line
<b>Length of Line</b>	22km	7.6km	6.2km
<b>Series Compensated (Yes/No)</b>	NO	NO	NO
<b>Connected to dedicated CT core (mention name)</b>	CORE-1 for main-1, CORE-2 for main-2, CORE-3 for metering, CORE-4 SPARE	CORE-1 for main-1, CORE-2 for main-2, CORE-3 for metering, CORE-4 SPARE	CORE-1 for main-1, CORE-2 for main-2, CORE-3 for metering, CORE-4 SPARE
<b>CT Ratio</b>	800:1	800:1	800:1
<b>Connected to dedicated PT core (mention name)</b>	CORE-1 for main-1, CORE-2 for main-2, CORE-3 for metering	CORE-1 for main-1, CORE-2 for main-2, CORE-3 for metering	CORE-1 for main-1, CORE-2 for main-2, CORE-3 for metering
<b>PT Ratio</b>	132KV:110V	132KV:110V	132KV:110V
<b>Relay connected to Trip Coil-1 or 2 or both</b>	Both	Both	Both
<b>Feed from DC supply-1 or 2</b>	Both	Both	Both
<b>i</b>	Main-I Protection (Make and Model)	Siemens SIPROTEC7SA52	MICOM P442
	Functional (Yes/No)	Yes	Yes
	Date of testing	-	-
<b>ii</b>	Main-II Protection (Make and Model)	MICOM P127	MICOM P143

		<b>Tr Line 1</b>	<b>Tr Line 2</b>	<b>Tr Line 3</b>
	Functional (Yes/No)	Yes	Yes	Yes
	Date of testing	-	-	-
<b>iii</b>	LBB Protection (Make and Model)	Micom Areva P821	Micom Areva P821	Micom Areva P821
	Functional (Yes/No)	NO	NO	NO
	Date of testing	-	-	-
<b>iv</b>	PLCC/ Protection coupler (Make and Model)	-	-	-
	Functional (Yes/No)	NA	NA	NA
<b>v</b>	DR (Make &Model) (Make and Model)	NA	NA	NA
	Functional (Yes/No)	NA	NA	NA
<b>vi</b>	Time Synch.Unit (Make and Model)	SANDS	SANDS	SANDS
	Functional (Yes/No)	YES	YES	YES
<b>1</b>	Status of Power Swing	ENABLE	ENABLE	ENABLE
<b>2</b>	Out of Step	1	1	1
<b>3</b>	SOTF	ENABLE	ENABLE	ENABLE
<b>4</b>	Breaker Failure	ENABLE	ENABLE	ENABLE
<b>5</b>	Broken Conductor	ENABLE	ENABLE	ENABLE

		<b>Tr Line 1</b>	<b>Tr Line 2</b>	<b>Tr Line 3</b>
<b>6</b>	STUB	ENABLE	ENABLE	ENABLE
<b>7</b>	Fault Locator	ENABLE	ENABLE	ENABLE
<b>8</b>	Disturbance Recorder	VISIBLE	VISIBLE	VISIBLE
<b>9</b>	VT fuse fail	ENABLE	ENABLE	ENABLE
<b>10</b>	Overvoltage Protection	DISABLE	DISABLE	DISABLE
<b>11</b>	Trip Circuit supervision	ENABLE	ENABLE	DISABLE
<b>12</b>	Auto-reclose	DISABLE	DISABLE	DISABLE
<b>13</b>	Load encroachment	-	-	-

## Bus-Bar Protection

### 220KV System:

S. No.	Particulars	Observations
1	Busbar and redundant relay make and model	Alstom
2	Type of Busbar arrangement	2 main and transfer
3	Zones	Three (Bus-1, Bus-2 and Check)
4	Dedicated CT core for each busbar protection	Yes
5	Breaker Failure relay included, if additional then furnish make and model	In case of any BFR operating in substation, the relevant zone will be tripped.
6	Trip issued to both Busbar protection in case of enabling	Not applicable
7	Isolator indication and check relays	This is part of Bay Unit
8	Other requirements for protection checking and validation	The Bus-bar protection relay was replaced, but is not compatible with Bay Units. Therefore, bus bar protection system is out of service. Utility has informed that zone IV of all distance protection is set in reverse direction and 160 ms (less than zone 2 time), in the absence of bus-bar protection.

### 132KV System: NA

## AC Auxiliary System

Sl. No.	Particulars	Observations
1	Source of AC auxiliary system	2 nos. 630KVA Station Transformers connected with 33KV Busbar.
2	Supply changeover between sources (Auto/Manual)	Load is distributed between two transformers. The emergency load is connected to separate distribution board.
3	Diesel generator (DG) details	Make: Sonalika Rating: 25KVA
4	Maintenance plan and supply changeover periodicity in DG	a. The DG set operation is automatic, however, load manually connected, as DG is not capable of catering full emergency loads. b. As the auxiliary supply is quite reliable, DG operation is almost negligible. For testing purpose, DG is operated once a week.
5	Single Line Diagram	Attached
6	Other requirements for protection checking and validation	NA



## DC Auxiliary System

Sl. No.	Particulars	Observations			
		220 V DC - I	220 V DC – II	48 V DC-I	48 V DC-II
1	Make	NA	NA	NA	NA
2	Model/Rating	400Ah	400Ah	400Ah	NA
3	Vintage	NA	NA	NA	NA
4	Measured voltage				
A	Positive to Earth	0	0	NA	NA
B	Negative to Earth	-220	-220	48	NA
5	No. of Cells Per Bank	NA	NA	NA	NA
6	Availability of Battery Charger	Yes	Yes	Yes	Yes

## Circuit Breakers

Sl. No.	Particulars	Make and Model	No. of trip/close coil	Trip Coil Supervision relay and healthiness of coils	LBB Setting Stage 1	LBB Setting Stage 2	Remarks (If any)
<b>A</b>	<b>220KV System</b>						
1	220 KV BAREILLY	MAKE- CGL TYPE-200- SFM-40S	2/1	HEALTHY	ENABLE TIME DELAY- 200 ms	ENABLE	-
2	220 KV KASHIPUR,50 MVA T/F I&II (HV SIDE)	MAKE-ABB TYPE- LTB245E1	2/1	HEALTHY	ENABLE TIME DELAY-200 ms	DISABLE	-
3	220 KV HALDWANI, TATA MOTOR, JAFARPUR,160 MVA I&II HV (SIDE)	MAKE-CGL TYPE-200- SFM-50AA	2/1	HEALTHY	ENABLE TIME DELAY-200 ms	DISABLE	-
<b>B</b>	<b>132KV System</b>						
1	132 KV RUDRAPUR, HINDUSTAN ZINC,160 MVA T/F I&II LV,80 MVA T/F I&II (HV SIDE)	MAKE-CGL, TYPE-120- SFM-32B	2/1	HEALTHY	ENABLE TIME DELAY-200 ms	DISABLE	-

## Current Transformer

<b>a</b>	<b>Location of CT</b>	<b>220 KV BARIELLY</b>				
<b>b</b>	Date of CT ratio Test Testing	NA				
		<b>Core I</b>	<b>Core II</b>	<b>Core III</b>	<b>Core IV</b>	<b>Core V</b>
<b>c</b>	Accuracy Class	PS	PS	0.2	PS	PS
<b>d</b>	Purpose	21 M1 PROTECTION	21 M2 PROTECTION	METERING	MW, MVAR, AMMETER	BUS-BAR PROTECTION
<b>e</b>	Test Results					
<b>i</b>	Ratio Adopted	1600	1600	800	1600	1600
<b>ii</b>	Ratio measured	NA	NA	NA	NA	NA

<b>a</b>	<b>Location of CT</b>	<b>220 KV HALDWANI</b>				
<b>b</b>	Date of CT ratio Test Testing	NA				
		<b>Core I</b>	<b>Core II</b>	<b>Core III</b>	<b>Core IV</b>	<b>Core V</b>
<b>c</b>	Accuracy Class	PS	PS	0.2	PS	PS
<b>d</b>	Purpose	21M1 PROTECTION	21 M2 PROTECTION	METERING	BUS-BAR PROTECTION	SPARE
<b>e</b>	Test Results					
<b>i</b>	Ratio Adopted	1600	1600	800	1600	1600
<b>ii</b>	Ratio measured	NA	NA	NA	NA	NA

<b>a</b>	<b>Location of CT</b>	<b>220 KV KASHIPUR</b>				
<b>b</b>	Date of CT ratio Test Testing	27/09/2021				
		<b>Core I</b>	<b>Core II</b>	<b>Core III</b>	<b>Core IV</b>	<b>Core V</b>
<b>c</b>	Accuracy Class	PS	PS	0.2	PS	PS
<b>d</b>	Purpose	21M1 PROTECTION	21M2 PROTECTION	METERING	BUS BAR PROTECTION	SPARE
<b>e</b>	Test Results					
<b>i</b>	Ratio Adopted	1600	1600	800	1600	1600
<b>ii</b>	Ratio measured	NA	NA	NA	NA	NA

<b>a</b>	<b>Location of CT</b>	<b>220 KV TATA MOTOR</b>				
<b>b</b>	Date of CT ratio Test Testing	NA				
		<b>Core I</b>	<b>Core II</b>	<b>Core III</b>	<b>Core IV</b>	<b>Core V</b>
<b>c</b>	Accuracy Class	PS	PS	0.2	PS	PS
<b>d</b>	Purpose	21 M1 PROTECTION	21M2 PROTECTION	METERING	BUS BAR PROTECTION	SPARE
<b>e</b>	Test Results					
<b>i</b>	Ratio Adopted	1600	1600	100	1600	1600
<b>ii</b>	Ratio measured	NA	NA	NA	NA	NA

<b>a</b>	<b>Location of CT</b>	<b>132 KV HALDWANI</b>				
<b>b</b>	Date of CT ratio Test Testing	NA				
		<b>Core I</b>	<b>Core II</b>	<b>Core III</b>	<b>Core IV</b>	<b>Core V</b>
<b>c</b>	Accuracy Class	PS	PS	0.2	PS	-
<b>d</b>	Purpose	21 M1 PROTECTION	67/67N PROTECTION	METERING	SPARE	-
<b>e</b>	Test Results					
<b>i</b>	Ratio Adopted	800:1	800:1	800:1	800:1	
<b>ii</b>	Ratio measured	800:1	800:1	800:1	800:1	

<b>a</b>	<b>Location of CT</b>	<b>220 KV JAFARPUR</b>				
<b>b</b>	Date of CT ratio Test Testing	27/09/2021				
		<b>Core I</b>	<b>Core II</b>	<b>Core III</b>	<b>Core IV</b>	<b>Core V</b>
<b>c</b>	Accuracy Class	PS	PS	0.2	PS	PS
<b>d</b>	Purpose	21 M1 PROTECTION	21 M2 PROTECTION	METERING	BUS BAR PROTECTION	SPARE
<b>e</b>	Test Results					
<b>i</b>	Ratio Adopted	1600	1600	800	1600	1600
<b>ii</b>	Ratio measured	NA	NA	NA	NA	NA

<b>a</b>	<b>Location of CT</b>	<b>132 KV RUDRAPUR</b>				
<b>b</b>	Date of CT ratio Test Testing	NA				
		<b>Core I</b>	<b>Core II</b>	<b>Core III</b>	<b>Core IV</b>	<b>Core V</b>
<b>c</b>	Accuracy Class	PS	PS	0.2	PS	-
<b>d</b>	Purpose	21 M1 PROTECTION	67/67N PROTECTION	METERING	SPARE	-
<b>e</b>	Test Results					
<b>i</b>	Ratio Adopted	800	800	800	800	
<b>ii</b>	Ratio measured	NA	NA	NA	NA	

<b>a</b>	<b>Location of CT</b>	<b>132 KV HZL</b>				
<b>b</b>	Date of CT ratio Test Testing	04/10/2021				
		<b>Core I</b>	<b>Core II</b>	<b>Core III</b>	<b>Core IV</b>	<b>Core V</b>
<b>c</b>	Accuracy Class	PS	PS	0.2	PS	-
<b>d</b>	Purpose	21 M1 PROTECTION	67/67N PROTECTION	METERING	SPARE	-
<b>e</b>	Test Results					
<b>i</b>	Ratio Adopted	800:1	800:1	800:1	800:1	-
<b>ii</b>	Ratio measured	800:1	800:1	800:1	800:1	-

## Capacitive Voltage Transformer/Potential Transformer

<b>a Location of CVT/PT</b>		<b>220 KV BAREILLY</b>		
<b>b</b>	Date of CVT/PT ratio Test Testing	NA		
		<b>Core I</b>	<b>Core II</b>	<b>Core III</b>
<b>c</b>	Accuracy Class	3P	3P	0.5
<b>d</b>	Purpose	21 M1 PROTECTION	21 M2 PROTECTION	METERING
<b>e</b>	Test Results			
<b>i</b>	Ratio Adopted	2000	2000	2000
<b>ii</b>	Ratio measured	NA	NA	NA

<b>a Location of CVT/PT</b>		<b>220 KV HALDWANI</b>		
<b>b</b>	Date of CVT/PT ratio Test Testing	NA		
		<b>Core I</b>	<b>Core II</b>	<b>Core III</b>
<b>c</b>	Accuracy Class	3P	3P	0.5
<b>d</b>	Purpose	21 M1 PROTECTION	21 M2 PROTECTION	METERING
<b>e</b>	Test Results			
<b>i</b>	Ratio Adopted	2000	2000	2000
<b>ii</b>	Ratio measured	NA	NA	NA

<b>a Location of CVT/PT</b>		<b>220 KV JAFARPUR</b>		
<b>b</b>	Date of CVT/PT ratio Test Testing	NA		
		<b>Core I</b>	<b>Core II</b>	<b>Core III</b>
<b>c</b>	Accuracy Class	3P	3P	0.5
<b>d</b>	Purpose	21 M1 PROTECTION	21 M2 PROTECTION	METERING
<b>e</b>	Test Results			
<b>i</b>	Ratio Adopted	2000	2000	2000
<b>ii</b>	Ratio measured	NA	NA	NA

<b>a Location of CVT/PT</b>		<b>220 KV KASHIPUR</b>		
<b>b</b>	Date of CVT/PT ratio Test Testing	NA		

		<b>Core I</b>	<b>Core II</b>	<b>Core III</b>
<b>c</b>	Accuracy Class	3P	3P	0.5
<b>d</b>	Purpose	21 M1 PROTECTION	21 M2 PROTECTION	METERING
<b>e</b>	Test Results			
<b>i</b>	Ratio Adopted	2000	2000	2000
<b>ii</b>	Ratio measured	NA	NA	NA

<b>a</b>	<b>Location of CVT/PT</b>	<b>220 KV TATA MOTOR</b>		
<b>b</b>	Date of CVT/PT ratio Test Testing	NA		
		<b>Core I</b>	<b>Core II</b>	<b>Core III</b>
<b>c</b>	Accuracy Class	3P	3P	0.5
<b>d</b>	Purpose	21 M1 PROTECTION	21 M2 PROTECTION	METERING
<b>e</b>	Test Results			
<b>i</b>	Ratio Adopted	2000	2000	2000
<b>ii</b>	Ratio measured	NA	NA	NA

<b>a</b>	<b>Location of CVT/PT</b>	<b>132 KV RUDRAPUR</b>		
<b>b</b>	Date of CVT/PT ratio Test Testing	NA		
		<b>Core I</b>	<b>Core II</b>	<b>Core III</b>
<b>c</b>	Accuracy Class	3P	3P	0.5
<b>d</b>	Purpose	21 M1 PROTECTION	67/67N PROTECTION	METERING
<b>e</b>	Test Results			
<b>i</b>	Ratio Adopted	1200	1200	1200
<b>ii</b>	Ratio measured	NA	NA	NA

<b>a</b>	<b>Location of CVT/PT</b>	<b>132 KV HALDWANI</b>		
<b>b</b>	Date of CVT/PT ratio Test Testing	NA		
		<b>Core I</b>	<b>Core II</b>	<b>Core III</b>
<b>c</b>	Accuracy Class	3P	3P	0.5
<b>d</b>	Purpose	21 M1 PROTECTION	67/67N PROTECTION	METERING
<b>e</b>	Test Results			
<b>i</b>	Ratio Adopted	1200	1200	1200
<b>ii</b>	Ratio measured	NA	NA	NA

<b>a</b>	<b>Location of CVT/PT</b>	<b>132 KV HZL</b>		
<b>b</b>	Date of CVT/PT ratio Test Testing	NA		
		<b>Core I</b>	<b>Core II</b>	<b>Core III</b>
<b>c</b>	Accuracy Class	3P	3P	0.5
<b>d</b>	Purpose	21 M1 PROTECTION	67/67N PROTECTION	METERING
<b>e</b>	Test Results			
<b>i</b>	Ratio Adopted	1200	1200	1200
<b>ii</b>	Ratio measured	NA	NA	NA



## Disturbance Recorder (DR) & Event Logger (EL)

Sl. No.	Particulars	220KV	132KV
1	a) Is the Disturbance recorder and Fault locator provided on all line feeders?	Yes	Yes
	b) Whether standalone or built in Main relay	Built-In	Built-In
	c) Whether DR is having automatic fault record download facility to a central PC	No	No
	d) Whether Central PC for DR, EL are powered by Inverter (fed from station DC)	NA	NA
2	Whether substation is having Event logger facility	Yes	Yes
	If Yes (standalone or built-in-SAS)	Built-In	Built-In
3	Whether GPS based time synchronizing equipment is provided at the substation for time synchronizing of Main relays / DR/ Event logger / SAS/ PMU / Line Current Differential Relays	Yes 2 Nos. (one for SAS & one for Relays/Equipment)	

## Communication System

Sl. No.	Name of Line Feeder	PLCC/OPGW/none	If PLCC for protection(y/n)	Coupling type & no. Of channel	If OPGW for protection(y/n)	Geographically distributed for main-1 & main-2 dedicated/multiplexed
1	220KV Pantnagar-Kashipur Line	PLCC & OPGW both	No	Ph-Ph	Yes	No, Dedicated
2	220KV Pantnagar-Jafarpur Line	PLCC	NA at other end	Ph-Ph	No	NA
3	220KV Pantnagar-Haldwani Line	PLCC & OPGW both	No	Ph-Ph	Yes	No, Dedicated
4	220KV Tata Motors Line	PLCC	No	Ph-Ph	No	NA
5	220KV Pantnagar-Bareilly Line	PLCC UNDER PROCESS	No	NA	No	NA
6	132KV HZL Line	PLCC	No	Ph-N	No	NA
7	132KV Pantnagar-Rudarpur Line	PLCC&OPGW both	No	Ph-N	Yes	No, Dedicated
8	132KV Pantnagar-Haldwani Line	PLCC	No	Ph-N	No	NA

## Transformer Protection

Particulars	TF-1	TF-2	TF-3	TF-4	TF-5	TF-6
<b>Name of ICT</b>	220/132KV 160 MVA T/F-I	220/132KV 160 MVA T/F-II	220/33KV 50MVA T/F-I	220/33KV 50MVA T/F-II	132/33KV 80MVA T/F-I	132/33KV 80MVA T/F-II
<b>Make</b>	BHEL	BHEL	IMP	IMP	BHEL	BHEL
<b>Connected to dedicated CT core (HV Bay)</b>						
<b>Core-1</b>	Differential Protection	Differential Protection	Differential Protection	Differential Protection	Differential Protection	Differential Protection
<b>Core-2</b>	Over Current Protection	Over Current Protection	Over Current Protection	Over Current Protection	Over Current Protection	Over Current Protection
<b>Core-3</b>	Metering	Metering	Metering	Metering	Metering	Metering
<b>Core-4</b>	Busbar protection	Busbar protection	Busbar protection	Busbar protection	Spare	Spare
<b>Core-5</b>	Spare	Spare	Spare	Spare	NA	NA
<b>CT ratio</b>	600:1	600:1	200:1	200:1	400:1	400:1
<b>Connected to dedicated Bus CVT core (HV Bay)</b>						
<b>Core-1</b>	Metering	Metering	Metering	Metering	Metering	Metering
<b>Core-2</b>	Directional Over Current Protection	Directional Over Current Protection	Directional Over Current Protection	Directional Over Current Protection	Directional Over Current Protection	Directional Over Current Protection
<b>Core-3</b>	Differential protection	Differential protection	Differential protection	Differential protection	Differential protection	Differential protection
<b>CVT ratio</b>	220KV:110V	220KV:110V	220KV:110V	220KV:110V	132KV:110V	132KV:110V
<b>Relay connected to Trip Coil-1 or 2 or both (HV)</b>	Both	Both	Both	Both	Both	Both
<b>Feed from DC supply-1 or 2(LV)</b>	Both	Both	Both	Both	Both	Both
<b>Connected to dedicated CT core (LV Bay)</b>						
<b>Core-1</b>	Differential Protection	Differential Protection	Differential Protection	Differential Protection	Differential Protection	Differential Protection

<b>Particulars</b>	<b>TF-1</b>	<b>TF-2</b>	<b>TF-3</b>	<b>TF-4</b>	<b>TF-5</b>	<b>TF-6</b>
<b>Core-2</b>	Over Current Protection	Over Current Protection	Over Current Protection	Over Current Protection	Over Current Protection	Over Current Protection
<b>Core-3</b>	Metering	Metering	Metering	Metering	Metering	Metering
<b>Core-4</b>	Busbar protection	Busbar protection	Busbar protection	Busbar protection	Spare	Spare
<b>Core-5</b>	Spare	Spare	Spare	Spare	NA	NA
<b>CT ratio</b>	1200:1	1200:1	1200:1	1200:1	1600:1	1600:1
<b>Connected to dedicated Bus CVT core (LV Bay)</b>						
<b>Core-1</b>	Metering	Metering	Metering	Metering	Metering	Metering
<b>Core-2</b>	Directional Over Current Protection	Directional Over Current Protection	Directional Over Current Protection	Directional Over Current Protection	Directional Over Current Protection	Directional Over Current Protection
<b>Core-3</b>	Differential protection	Differential protection	Differential protection	Differential protection	Differential protection	Differential protection
<b>CVT ratio</b>	132KV:110V	132KV:110V	33KV:110V	33KV:110V	33KV:110V	33KV:110V
<b>Relay connected to Trip Coil-1 or 2 or both (HV)</b>	Both	Both	Both	Both	Both	Both
<b>Feed from DC supply-1 or 2(LV)</b>	Both	Both	Both	Both	Both	Both
<b>LA Rating/ HV Side</b>	Rated voltage=198KV, Discharge current=10KA	Rated voltage=198KV, Discharge current=10KA	Rated voltage=198KV, Discharge current=10KA	Rated voltage=198KV, Discharge current=10KA	Rated voltage=60KV, Discharge current=10KA	Rated voltage=60KV, Discharge current=10KA
<b>LA Rating/ LV Side</b>	Rated voltage=60KV, Discharge current= 10KA	Rated voltage=60KV, Discharge current= 10KA	Rated voltage=30KV, Discharge current= 10KA	Rated voltage=30KV, Discharge current= 10KA	Rated voltage=30KV, Discharge current= 10KA	Rated voltage=30KV, Discharge current=10KA
<b>Date of last testing of</b>	5/11/2023	5/11/2023	5/11/2023	5/11/2023	5/11/23023	5/11/2023

Particulars		TF-1	TF-2	TF-3	TF-4	TF-5	TF-6
<b>Protection</b>							
<b>Group A Protection</b>							
1	Differential Protection (Make & Model)	AREVA MiCOM P643	AREVA MiCOM P643	ABB RET 650	ABB RET 650	AREVA MiCOM P643	AREVA MiCOM P643
2	PRV	OK	OK	OK	OK	OK	OK
3	WTI Indication working	YES	YES	YES	YES	YES	YES
4	Back-up Over Current Protection HV (Make & Model)	AREVA MICOM P127	AREVA MICOM P127	ABB REF615	ABB REF615	AREVA MICOM P127	AREVA MICOM P127
5	Over Flux Protection (Make & Model) HV	NA	NA	NA	NA	NA	NA
<b>Group B Protection</b>							
1	REF Protection (Make & Model)	MAKE-ABB	MAKE-ABB	HV=ABB REF615, LV=MICOM ALSTOMP1 4DB	HV=ABB REF615, LV=MICOM ALSTOMP14DB	-	-
2	Bucholtz	Status healthy	Status healthy	Status healthy	Status healthy	Status healthy	Status healthy
3	Back-up Over Current Protection LV (Make & Model)	AREVA MICOM P127	AREVA MICOM P127	AREVA MICOM P14NB16A6 C0540A	AREVA MICOM P127	AREVA MICOM P143	AREVA MICOM P143
4	Over Flux Protection (Make & Model) LV	NA	NA	NA	NA	NA	NA
5	OTI Indication working	YES	YES	YES	YES	YES	YES

## Special Protection Scheme (SPS)

### SPS FOR GRID STABILITY THROUGH LOAD SHEDDING FROM VARIOUS SUBSTATION AT IN KUMAON REGION

Kumaon region has one of the largest 400 KV substation having transformation capacity of 2 X 315 MVA and is also connected through four Nos. POWERGRIDlines which caters approximately 60 % load of Kumaon and partial load of Garhwal region also. It is also connected to 400 KV Moradabad and 400 KV Nehtaur substations of Uttar Pradesh. It is also connected to two Gas based generators through 220 KV Lines having capacity of 110 MW and 225 mW capacity. In view of the above it acts as a gateway of chunk power for Kumaon region. This substation meets the power demand of Kashipur, Bazpur, Mahuakheraganj, Ramnagar and Jaspur. This substation also supplies the power to industrial area of SIDCUL Pantnagar, Haldwani and Kamaluaganja, Bhowali and portion of Kichha region also through two Nos 220 KV lines. One of them is directly connected to Pantnagar substation and another is connected to Pantnagar substation through 220 KV substation Jafarpur.

Another very important source of power is available at 220 KV substation Pantnagar from 220 KV substation Bareilly which compliments the power demand in Kumaon region together with the power available from 400 KV substation Kashipur.

Another source of power is available at 132 KV substation Pithoragarh and 132 KV substation Almora from PGCIL Chandak substation. This substation also compliments in maintaining the grid stability by providing the additional power supply required to meet the power demand of hilly region of Kumaon Zone.

There is another very important source of power supply available at 132 KV substation Sitarganj and ELDECO Sitarganj which meets the power demand of Sitarganj, ELDECO Sitarganj, Khatima, Kichha region and other nearby areas.

In view of the above it can be identified that at present there are four major source of power supply in Kumaon region which makes the interconnecting lines very crucial and important through which these sources cater the power supply to other region and also the lines which meets the N-1 contingency for these lines means acts as an alternate source of power in case these lines or sources goes off.

The total transformation capacity of Kumaon Region is 2542 MVA (total avg. loading 1644 MVA) and total load connected to transmission network is 138.5 MVA however the total power which can be supplied through various networks depends on following transmission elements-

- The two Nos. Transformers of 2 X 315 MVA capacity i.e., 630 MVA
- One No. 220 KV Bareilly-Pantnagar Line having single moose conductor of approximate 250 MVA capacity.
- One No. 220 KV Kashipur-Pantnagar Line and another line connecting 400 KV Kashipur to 220 KV substation Pantnagar through 220 KV substation Jafarpur.
- 132 KV Almora Chandak line in case of direction of power flow from Chandak to Almora.

- 132 KV Kathgodam-Bhowali line in case of direction of power flow from Bhowali to Almora.

*Note- These constraints have been taken without considering the generation received from two large gas power generators having generation capacity approx. 107 MVA and 225 MVA and various other small solar generators connected at 33 KV voltage level.*

The single line diagram of whole of the Kumaon region is enclosed for getting clear picture and understanding of the network and contingency.

The need of implementing the SPS in Kumaon region has arisen to avoid the occurrence of grid failure and black out situation in Kumaon region. The various cases of failure of grid are being discussed hereinbelow along with the solution through SPS to avoid grid failure.

### **Case-1**

#### **When 220KV Pantnagar-Bareilly line goes off and rest of the network remains intact.**

Generally, the average load on 220 KV Pantnagar-Bareilly line is approx. 230 MW. In case of failure of this line all the load is immediately shifts on both 220 KV line from 400 KV Kashipur to Pantnagar thereby putting an extra load of approx. 230 MW on 2 X 315 MVA transformers. The load on single 315 MVA transformer in general remains approximately 250 MVA i.e., both the transformers together cater 500 MVA load in normal conditions. If we consider to load these transformers for 100%, a window of only 130 MVA surplus loading on these transformers is available. Whereas in above situation extra load of approx. 230 MW takes place which trips the both 2X 315 MVA transformers at 400 KV substation Kashipur.

#### **SPS Scheme:**

**Contingency:** Tripping of 220KV Pantnagar- Bareilly Line carrying approx. 230 MW

Total load shift observed due to tripping of 220 KV Pantnagar - Bareilly on 2 x315 MVA transformer is 230 MVA

Available surplus loading on 2 X 315 MVA transformers at 400 KV = 130 MVA as well as approx. 30 MW load can be transfer to Chandak-Almora Line.

**Action 1:** - Required load shedding from Rudrapur and Kichcha is approx. load 70 MW to save both transformers from tripping. 70 MW load shedding shall be done by tripping of both 40 MVA Transformer at 132 KV Rudrapur and disconnection of 132 KV Rudrapur-Kichcha Line. This will be done by reading zero currents from relay installed on 220 KV Bareilly line send Carrier Signal to 132 KV Rudrapur s/s through FOTE.

**Action 2:** - With tripping of 220KV Pantnagar-Bareilly Line, 132 KV Pantnagar Kathgodam as well as 132 KV Kamaluaganja-Kathgodam disconnected so as to create Islanding at 132 KV Kathgodam to avoid overloading of 132 KV Chandak-Almora Line. This will give approx. 30 MW load relaxation on 315 MVA ICTs.

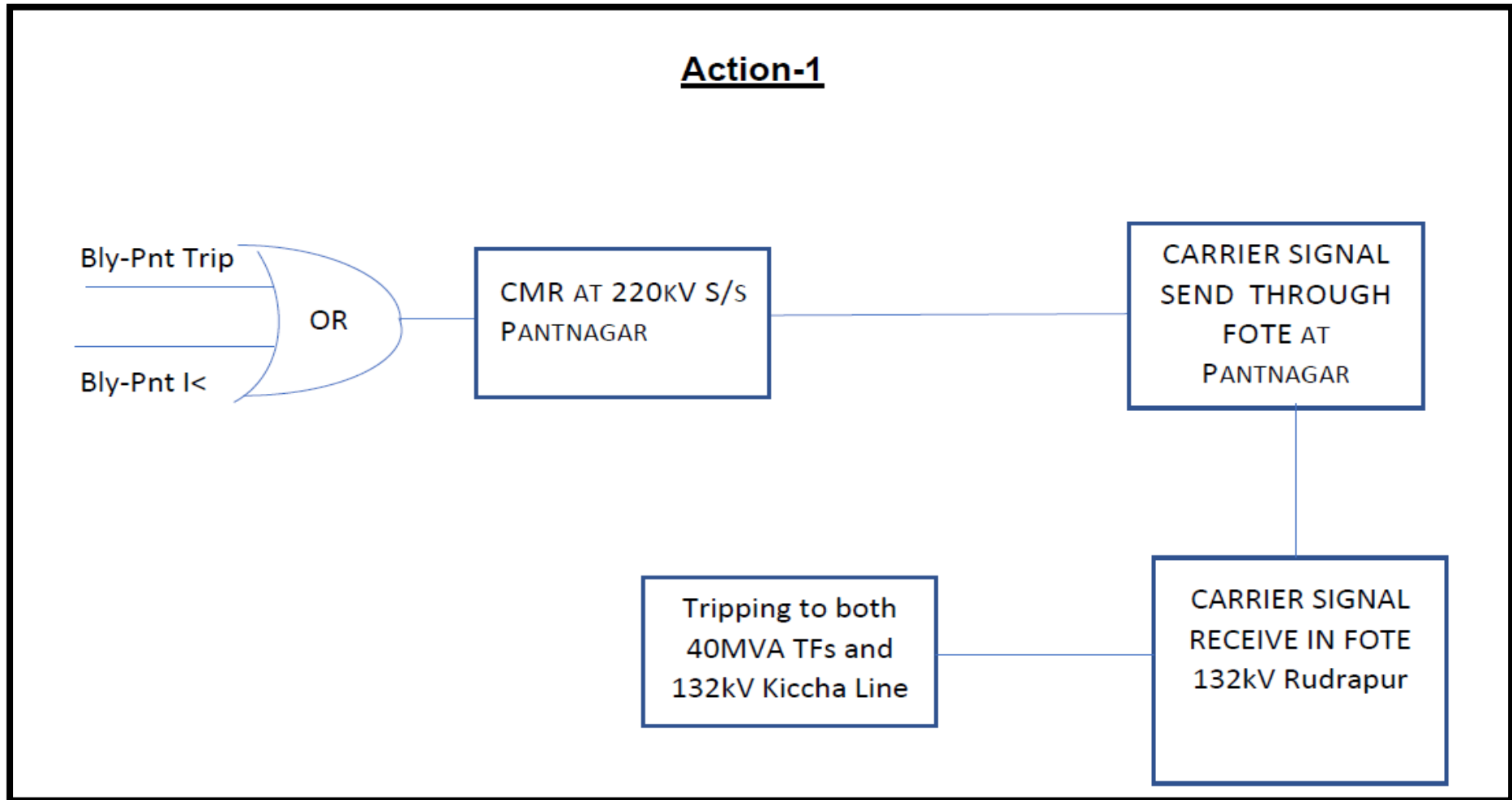



### Action-2

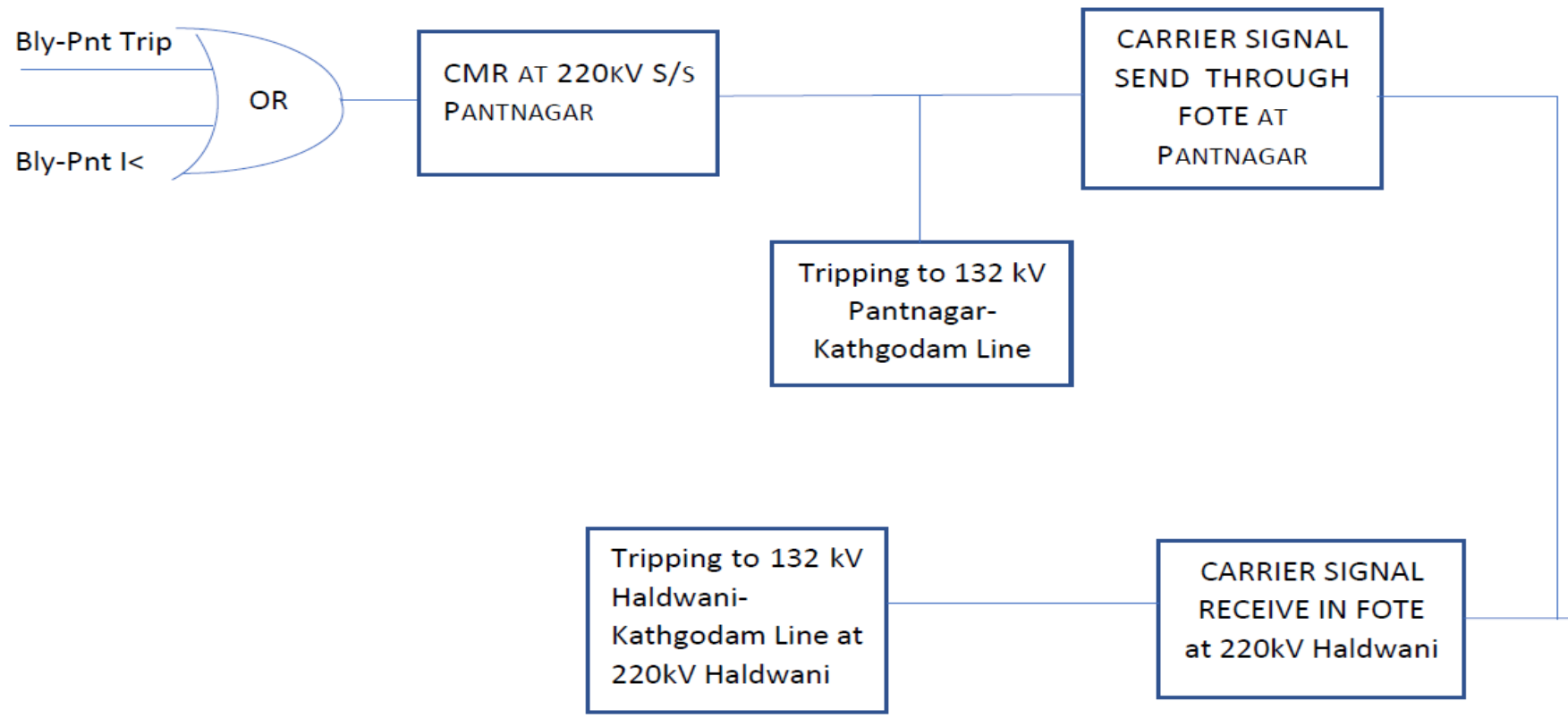

Case Discription	Peak load of Element tripped	Total Load Shedding Required	Name of Substation	Load Shedding at substation	Remark
220kV Pantnagar-Bareilly line trip and other lines are normal	230MW	70MW	132kV Rudrapur	50MW	To save 315MVA TFs at 400kV Kashipur from overloading
			132kV Kiccha	20MW	

#### Case 2:

#### When one of 315 MVA ICTs at 400 KV S/s Kashipur tripped.

Generally, the average load on each 315MVA transformer is approx. 250MVA when there is no generation available from the two Gas based generators at Mahuakheraganj region. In case of tripping of any one of 315MVA Transformer, all the load is immediately shifts on other 315MVA transformer thereby putting an extra load of approx. 250MVA on 1 X 315MVA transformer. If we consider to load the transformer for 100%, a window of only 65MVA surplus loading on single transformer is available. Whereas in above situation extra load of approx. 250MVA takes place which also trips the other 315 MVA transformer at 400 KV substation Kashipur.

#### SPS Scheme:

**Contingency:** - Tripping of any one 315MVA transformer carrying approx. 250MVA

Total load shift observed due to tripping of one 315MVA transformer on other 315 MVA transformer is =250MVA

Available surplus loading on 1X 315MVA transformer at 400 KV Kashipur=65MVA.

**Action 1:** - Required load shedding at 400KV S/s Kashipur is approx. 185 MW to save other transformer shall be done by tripping 220KV Kashipur-Pantnagar line and 220KV Kashipur-Jafarpur line at 400KV S/s Kashipur thus making Kashipur region a separate island. After this all

load of Pantnagar region and Kamalwaganja region shifted to 220KV Pantnagar-Bareilly line, due to this load shifting 220KV Pantnagar-Bareilly line may get overload.

**Action 2:** - To avoid overloading of 220KV Pantnagar- Bareilly line some load relief is being done by tripping 132KV Kathgodam feeder at 220KV S/s Kamalwaganja and both 40MVA Transformers at 132KV S/s Rudrapur using PLCC/FOTE communication.

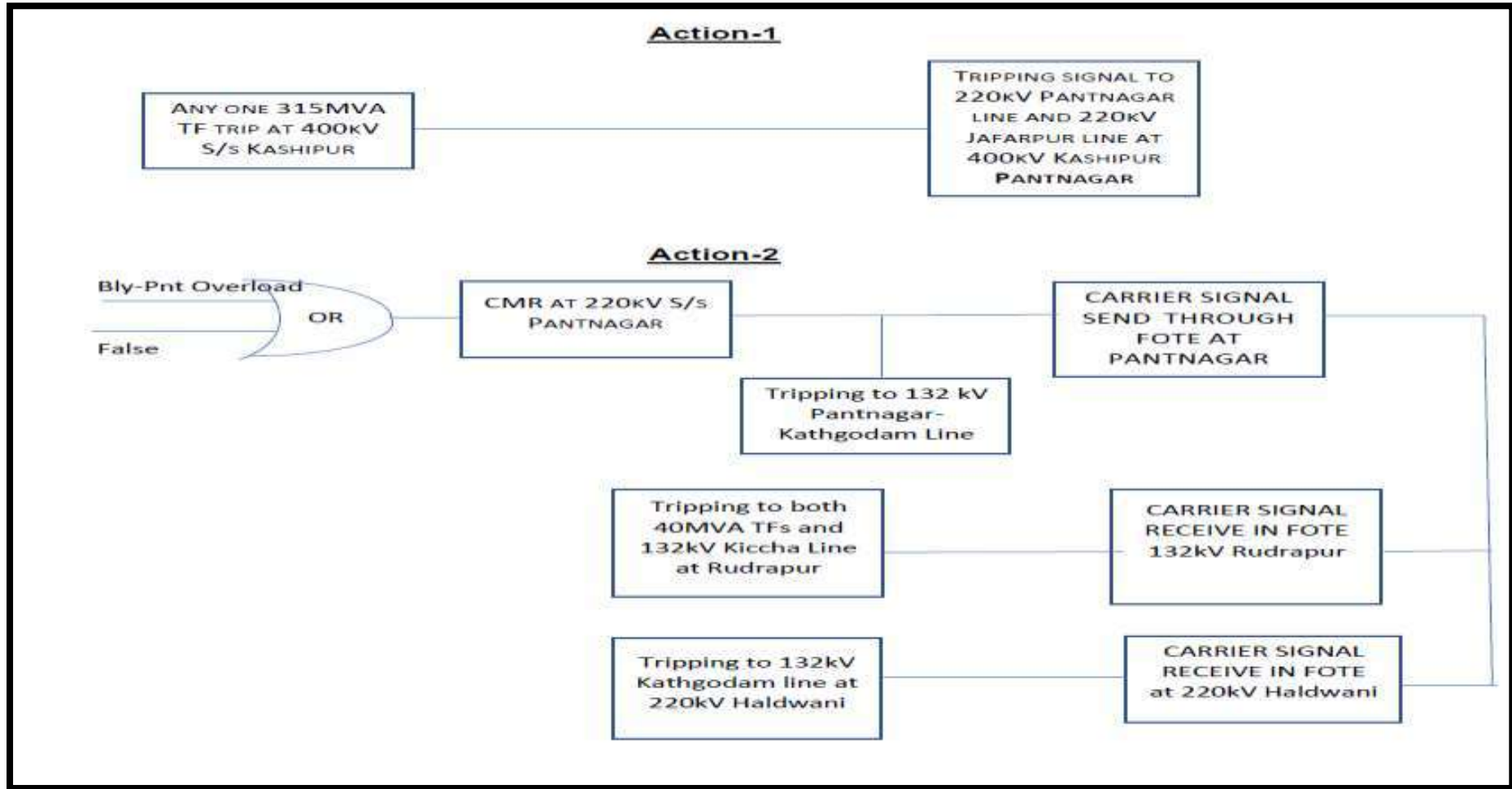

# Network Diagram of Uttarakhand

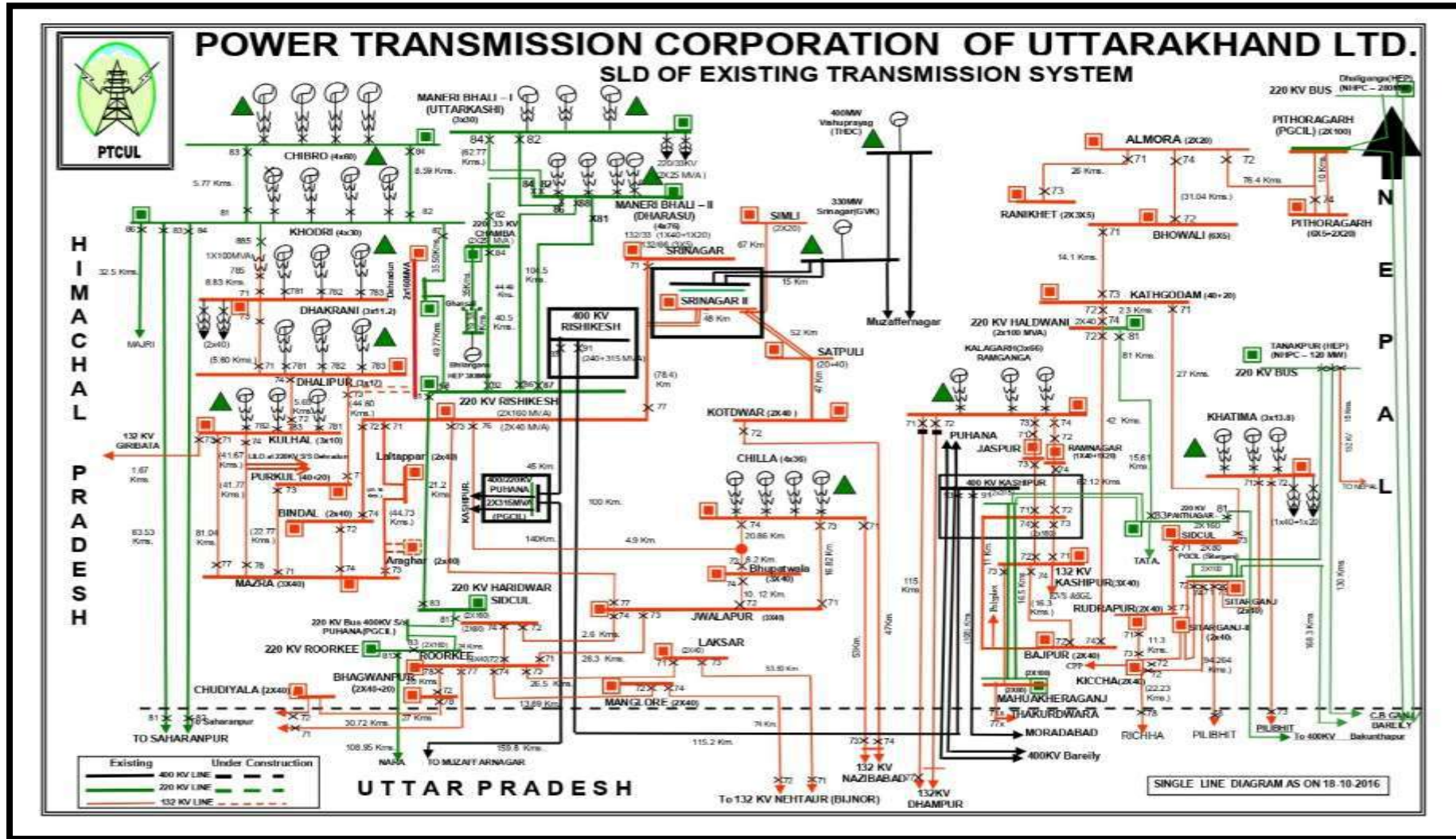



# Power Map of Uttarakhand

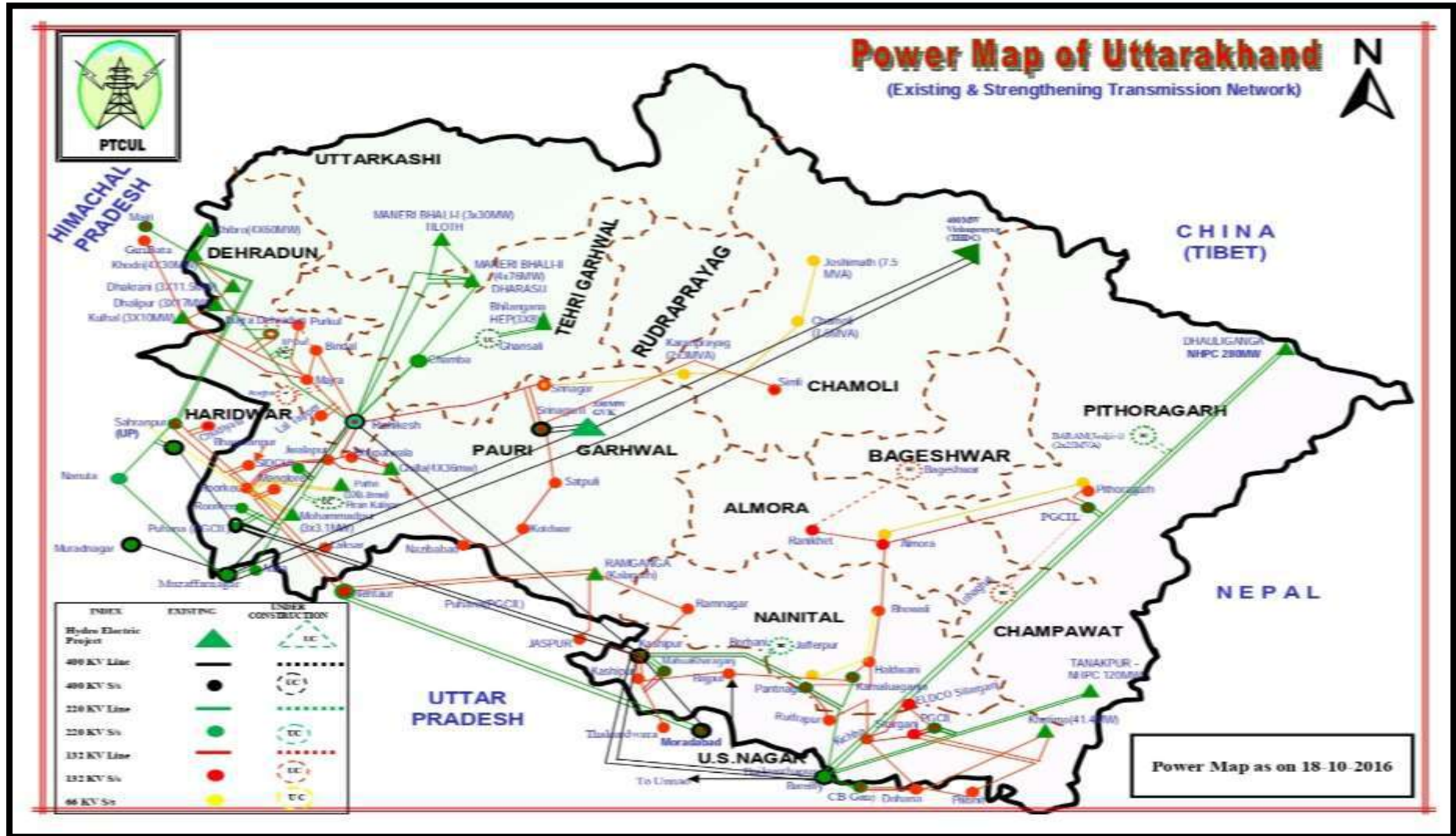



# **Power Transmission Corporation of Uttarakhand Limited**

(A Govt. of Uttarakhand Undertaking)

Corporate ID No.: U40101UR2004SGC028675

## **FINAL REPORT**

### **Protection Audit**

#### **400/220KV Kashipur Substation**

**Submitted**

**By**



**CENTRAL BOARD OF IRRIGATION & POWER**

**NEW DELHI**



# केन्द्रीय सिंचाई व शक्ति मंडल CENTRAL BOARD OF IRRIGATION AND POWER

25<sup>th</sup> June 2024

Order No.: 376/SE (T&C)/PTCUL/(H). dated: 29.09.2023

## Protection Audit Report

FINAL PROTECTION AUDIT REPORT OF 400/220/132 KV KASHIPUR SUB-STATION UNDER POWER TRANSMISSION CORPORATION OF UTTARAKHAND LIMITED (PTCUL), UTTARAKHAND.

Submitted  
To



**Power Transmission Corporation of Uttarakhand Limited**  
(A Govt. of Uttarakhand Undertaking)  
Corporate ID No.: U40101UR2004SGC028675

## Contents

<b>Disclaimer</b> .....	6
<b>1.0. Executive Summary</b> .....	7
<b>2.0. Introduction</b> .....	9
2.1. <i>Background</i> .....	9
2.2. <i>Scope of Work</i> .....	9
2.3. <i>Audit Rationale</i> .....	10
2.4. <i>Audit Process</i> .....	11
2.5. <i>About Power Transmission Corporation of Uttarakhand (PTCUL)</i> .....	13
2.6. <i>About Central Board of Irrigation &amp; Power (CBIP)</i> .....	14
<b>3.0. Preliminary Audit of Kashipur Substation</b> .....	15
3.1. <i>General Information about Substation</i> .....	15
3.2. <i>Audit Team</i> .....	15
3.3. <i>Recommendation of last protection checking and validation</i> .....	16
3.4. <i>Review of existing settings at substation</i> .....	17
3.5. <i>Disturbance Recorder availability for the last 6 tripping's</i> .....	17
3.6. <i>Chronic reason of tripping, if any</i> .....	18
3.7. <i>Major non-conformity/deficiency observed</i> .....	18
<b>4.0. List of Trippings</b> .....	20
<b>5.0. Observations and Recommendations</b> .....	26
5.1. <i>Reporting of all the Tripping with DR/EL</i> .....	26
5.2. <i>Development of centralized database of relay settings</i> .....	26
5.3. <i>Review of test results of relay and equipment</i> .....	27
5.4. <i>Availability of Testing Kits</i> .....	27
5.5. <i>Up-dation of PTCUL Protection Philosophy</i> .....	27
5.6. <i>Simulation based study of protection system</i> .....	28
5.7. <i>Capacity Building of protection team</i> .....	28
5.8. <i>Updated Fault Level/ Short Circuit Level and Network information</i> .....	28
5.9. <i>General Protection related observations</i> .....	28
5.10. <i>O&amp;M Manual</i> .....	28
<b>6.0. Station Specific Observation and Recommendations</b> .....	29
6.1. <i>Protection related observations and recommendations</i> .....	29
6.2. <i>Equipment related observations and recommendations</i> .....	30
6.3. <i>Auxiliary Equipment related observations and recommendations</i> .....	30
<b>Annexure – 1: Suggested List of Testing Instruments</b> .....	31
<b>Annexure – 2: Suggested List of Substation Equipments</b> .....	32
<b>Annexure – 3: Suggested List of Maintenance Equipments</b> .....	33
<b>Annexure – 4: Protection Code (IEGC 2023 Chapter 4)</b> .....	34



<b>Annexure – 5: Third Party Protection System Checking &amp; Validation Template for a Substation (IEGC 2023 Annexure – 1)</b> .....	39
<b>Annexure – 6: Protection Philosophy/Protocol of Northern Region</b> .....	44
<b>Annexure – 7: Work Order &amp; Corrigendum</b> .....	50
<b>Annexure – 8: Data Sheets</b> .....	58

## ACRONYMS

<b>A</b>	Ampere
<b>AC</b>	Alternating Current
<b>AMP</b>	Annual Maintenance Plan
<b>CBIP</b>	Central Board of Irrigation and Power
<b>CT</b>	Current Transformer
<b>CVT</b>	Capacitive Voltage Transformer
<b>DC</b>	Direct Current
<b>DG</b>	Diesel Generator
<b>DPR</b>	Detailed Project Report
<b>DR</b>	Disturbance Recorder
<b>EL</b>	Event Logger
<b>EMTP</b>	Electromagnetic Transient Program
<b>GPS</b>	Global Positioning System
<b>ICT</b>	Inter Connecting Transformer
<b>IEGC</b>	Indian Electricity Grid Code
<b>KA</b>	Kilo Ampere
<b>KV</b>	Kilo Volt
<b>LBB</b>	Local Breaker Backup
<b>LEFT</b>	Earth Fault
<b>MVA</b>	Mega Volt Ampere
<b>NA</b>	Not Available
<b>NRPC</b>	Northern Regional Power Committee
<b>O&amp;M</b>	Operation & Maintenance
<b>OCC</b>	Operation Coordination Sub Committee
<b>PLCC</b>	Power Line Carrier Communication
<b>PSC</b>	Power System Sub Committee
<b>PSDF</b>	Power System Development Fund
<b>PT</b>	Potential Transformer
<b>PTCUL</b>	Power Transmission Corporation of Uttarakhand Limited.
<b>RLDC</b>	Regional Load Dispatch Centre
<b>RPC</b>	Regional Power Committee
<b>SAS</b>	Substation Automation System

<b>SLD</b>	Single Line Diagram
<b>SLDC</b>	State Load Dispatch Centre
<b>SOTF</b>	Switch On-To Fault
<b>SPS</b>	Special Protection Scheme
<b>UJVNL</b>	Uttarakhand Jal Vidyut Nigam Ltd
<b>UPCL</b>	Uttarakhand Power Corporation Ltd
<b>WTI</b>	Winding Temperature Indicator

## Disclaimer

The protection audit has been carried out based on the guidelines provided under various documents mentioned in the report. For the purpose of audit, the auditor(s) have relied upon the data made available by the client and information & clarifications made available, in the written or verbal form, by the officials of clients during site visit and later.

The report is not for public distribution and has been furnished solely for information and must not be reproduced or redistributed to others, except those concerned. No one can use the report as a base for any claim, demand or cause of action and, also no one is responsible for any loss incurred based upon the content of this report.

While every effort is made to ensure the accuracy and completeness of information contained, CBIP takes no responsibility and assumes no liability for any error/ omission or accuracy of the information. Recipients of this material should rely on their own judgments and conclusions from relevant sources before taking any decision.

## 1.0. Executive Summary

PTCUL awarded the work of Third-Party Protection Audit of 2 nos. 400KV and 8 nos. 220KV substations of PTCUL (“Utility”) to CBIP. CBIP planned the audit as per Audit process provided under Protection Code within Indian Electricity Grid Code 2023. In addition, the guidelines of Ramakrishna Committee for checking and validation and NRPC guidelines for Third Party Audit were also adhered too. The CBIP manual on protection (manual no 247-Revised), NRPC protection philosophy were also referred too.

As a part of audit process, utility was asked to provide set of information before start of audit. Team from CBIP consisting of Mr. Vijay Barthwal, Mr. M.R. Chauhan & Mr. Rounak Sen visited 400/220/132KV Kashipur Substation during 27<sup>th</sup> – 29<sup>th</sup> January 2024 and preliminary audit report was submitted on the spot. The representatives of utility were present during this process. Some more information was sought from the Utility.

Based on the data made available by Utility, draft of final report was submitted to Utility and after discussions, report was finalized. The details of audit process, data made available by Utility, observations from preliminary report and detailed observations and recommendations are provided in this report. Key observations and recommendations are summarized below.

### **General Observations and Recommendations for Organization Level implementation**

01. It is recommended that each substation to have a central repository for tripping reports, along with Time Synchronized DR/EL reports and analysis. A dedicated PC can be provided at each substation for the purpose.
02. The protection philosophy adopted by Utility, in general, is in alignment with protection philosophy adopted by NRPC. As the NRPC has recently updated the protection philosophy, PTCUL in consultation with SLDC may update protection philosophy for network not covered by NRPC too, if needed, and implement the same.
03. It is recommended that latest recommended relay settings, as per the NRPC protocol for 220KV & above Substations, along with setting calculations & parameters used for all the relays, be kept at each substation. This will help in proper fault analysis and ascertaining relay healthiness. Similarly, Relay settings for sub-stations below 220KV, based on any such protocol by SLDC, along with setting calculations and line parameters also needs to be maintained.
04. It is recommended that the detailed reports of test results for the relays and switchyard equipments be maintained at sub-station level.

05. Based on “Draft O&M Manual” of PTCUL and discussions with their officials, a list of testing equipment is suggested and enclosed at Point 5.4. It is recommended that the necessary testing equipment at substation/Sub-division/Division be arranged for regular testing of equipment at substations.
06. Simulation based studies or EMTP Studies should be carried out by the Utility, as per the requirement of IEGC.
07. For the protection system and SAS, PTCUL may undertake capacity building exercise for the officials involved in these activities.
08. It is recommended that the updated network information and short circuit level should be periodically reviewed and maintained at central level for revising the setting as per requirement.
09. It is suggested that utility may carry out exhaustive safety and technical audit of sub-stations apart from protection audit, either internally or thru’ third party for implementing the best practices in the sub-station. In addition, the existing draft O&M manual also be updated to take care of latest developments.

#### **Observations and Recommendations for 400/220/132KV Kashipur Substation**

01. Last protection audit was carried out on 27 July 2015. Updated compliance status of previous audit(s) needs to be maintained.
02. The tripping of 132 kV Kashipur-Kashipur line requires detailed investigation and it is recommended that record of remote end relay flags be maintained and necessary modifications in relay settings for 132 kV Kashipur-Kashipur line be carried out.
03. Bus Bar Protection panels for all 3 levels i.e. 400KV, 220KV and 132KV are installed. The status of commissioning of 400kV bus Bar protection needs to be updated. For 220 kv and 132 kV commissioning work to be expedited.
04. The SAS is not updated for new elements and not fully functional. It is recommended that SAS be updated as and when any change occurs and kept functional.
05. Relay REL551 for SEPL line is not connected to time synchronization due to non-availability of port. It is recommended to take necessary Corrective action.
06. Based on inputs provided by utility and analysis of data a list of suggested switchyard and maintenance equipment for replacement is provided in Annexure – 2.
07. Earth Fault in both 220V battery bank was observed. It is recommended to take necessary corrective action.
08. Emergency DG set operation is in manual mode. It is suggested to keep the DG set in Auto mode.

## 2.0. Introduction

### 2.1. Background

The work has been awarded to the Central Board of Irrigation & Power (CBIP) vide Work Order Number: 376/SE (T&C)/PTCUL/(H), dated: 29.09.2023 for Protection Audit of 02 Nos. 400KV and 08 Nos. 220KV Sub-Stations at Uttarakhand, for Power Transmission Corporation of Uttarakhand Limited (PTCUL) in reference to the offer submitted by CBIP to PTCUL vide ref. no. P-1/CBIP/PTCUL/Audit/2023, dated: 11.09.2023. A Kick-Off Meeting was held between PTCUL and CBIP at the office of SE (T&C), PTCUL, Kathgodam, Haldwani on 26<sup>th</sup> October 2023. Detailed discussions were held regarding process and methodology of Execution and Submission of reports of Protection Audit. As per the above-mentioned meeting, a corrigendum was released by PTCUL vide ref. no. 394/SE (T&C)/PTCUL/(H), dated: 26.10.2023.

**As per the given order, the protection audit of following sub-stations is to be carried out:**

1. 400KV Rishikesh
2. 400KV Kashipur
3. 220KV Chamba
4. 220KV Rishikesh
5. 220KV Roorkee
6. 220KV Haridwar (SIDCUL)
7. 220KV Jhajra
8. 220KV Pantnagar
9. 220KV Haldwani
10. 220KV Mahuakheraganj

### 2.2. Scope of Work

Review of the implemented protection schemes/philosophy for 400/220KV substations which includes protection of transmission lines, interconnecting transformers, line/bus reactors, bus bar, bus couplers etc. with respect to tripping in last one year as per latest guidelines of Ramakrishna committee/ CBIP/NRPC/International best practices, which includes review of the following:

- a. *Adequacy of primary and backup protection settings for protected equipment and suggest corrective measures.*
- b. *Availability/healthiness of PLCC communication links used for protection systems.*
- c. *Healthiness/adequacy of 220/110/50V DC system available at substations for protection application.*
- d. *Availability/healthiness of GPS system and time synchronization facility used for protection.*
- e. *Availability/healthiness of recording instruments like DRs /ELs for transmission lines protection.*
- f. *Test reports for assessing the healthiness of circuit breakers, CT & CVT based upon available test reports at sites.*
- g. *Field inspection of protection device for obsolescence of technology, suitability and healthiness.*
- h. *Prepare recommendation for replacement of obsolescence relays with compatible numerical relays will be provided.*
- i. *Checking of availability of DG Set / auxiliary DC supply at substations.*

### **2.3. Audit Rationale**

- a. PTCUL (Utility) has submitted a DPR for Replacement of certain equipments under PSDF scheme to Grid-India. Grid-India has asked PTCUL to carry out protection audit of certain substations.
- b. In addition, as per CERC IEGC 2023 Chapter-04 (Protection Code) Para - 15 (2) “All users shall also conduct third party protection audit of each substation at 220KV and above (132KV and above in NER) once in 5 years or earlier as advised by the respective RPC”.
- c. As per Para – 15 (4) of said Code, “The third-party protection audit report shall contain information sought in the format enclosed as Annexure–1. The protection audit reports, along with action plan for rectification of deficiencies detected, if any, shall be submitted to the respective RPC and RLDC or SLDC, as the case may be, within a month of submission of third-party audit report. The necessary compliance to such protection audit report shall be followed up regularly in the respective RPC”.
- d. Subsequently NRPC issued protection philosophy for Northern region developed in compliance of IEGC 2023, Version 2.0 which was approved in 71<sup>st</sup> NRPC meeting held on 29.01.2024. Accordingly, protection audit of 220KV and above Substations is being carried out by CBIP, as per IEGC-2023 Annexure-1.



## 2.4. Audit Process

- **PTCUL shall provide the following documents:**
  - a. The Network Diagram, covering the relevant assets
  - b. Latest relay settings adopted and calculations for respective sub-stations and transmission lines.
  - c. Annual maintenance plan (AMP), including the schedule and activities covered under AMP
  - d. Any specific issues covered under OCC and/or PSC of NRPC for relevant assets.
- For each substation, check-list shall be provided by PTCUL. During field visit, the information shall be verified.
- The minimum set of points on which checking and validation shall be carried out is provided as per annexure - 4 for the following available power system elements at station, as per attached formats:

Sl. No.	Elements
1	Transmission Line
2	Bus Reactor/Line Reactor
3	Inter-connecting Transformer
4	Busbar
5	AC auxiliary system
6	DC auxiliary system
7	Communication system
8	Circuit Breaker Details
9	Current Transformer Details
10	Capacitive Voltage Transformers Details
11	Any other equipment/system relevant for protection system operation

- During field visit, no testing of equipment and relay shall be carried out. The visual inspection, operational log shall be considered for audit purpose, apart from the documents provided by PTCUL
- A calibrated multi-meter shall be provided at sub-station for checking AC and DC voltages and currents online, wherever feasible, without impacting the sub-station operations.
- The preliminary report shall be prepared on the site and shall be signed by all the parties present, as given below:

S. No.	Issues	Remarks
1	Recommendation of last protection checking and validation	Status of works and pending issues if any
2	Review of existing settings at substation	Recommended Action
3	Disturbance Recorder out/ available for last 6 tripping's (Y/N)	Recommended Action
4	Chronic reason of tripping, if any	Recommended Action
5	Major non-conformity/deficiency observed	Recommended Action

- **The Final summary shall specifically mention minimum following points:**
  - The settings and scheme adopted are in line with agreed protection philosophy or any accepted guidelines (e.g., Ramakrishna guidelines or CBIP manual based).
  - The deviations from the RPC protection philosophy, if any and reasons for taking the deviations shall be recorded.
  - All the major general deficiency shall be listed in detail along with remedial recommendations.
  - The cases of protection maloperation (last 1 year) shall be analysed from tripping reports and the causes of failure along with corrective actions and recommendations based on the findings.

## ***2.5. About Power Transmission Corporation of Uttarakhand (PTCUL)***

The State of Uttarakhand's power transmission utility, PTCUL, was formerly known as Uttaranchal. According to the Uttar Pradesh State Reorganization Act 2000, this 27<sup>th</sup> state of the republic of India was formed on November 9, 2000, by dividing the Himalayan and surrounding North-Western districts of Uttar Pradesh.

The State of Uttaranchal in exercise of the power granted to it under section 63(4) of the State Re-Organization Act, 2000, formed two separate companies in power sector:

- Uttaranchal Jal Vidyut Nigam Ltd. (UJVNL) – For generation of Hydro-Electricity in the State.
- Uttaranchal Power Corporation Ltd. (UPCL) – For Transmission and Distribution of Electricity in the state.

Enactment of the Electricity Act 2003, a distinct watershed in the Indian Power Sector, made it mandatory for all the States to restructure their SEBs. As per the provisions of Electricity Act 2003, the State Government separated power transmission business from UPCL which was left only with distribution of electricity.

In order to manage Power Transmission Operations, a new company called Power Transmission Corporation of Uttaranchal Ltd. was established. On 27<sup>th</sup> May, 2004, the firm was formed as a Government Company in accordance with section 617 of the Companies Act, 1956. It began operating from 1<sup>st</sup> June, 2004.

The company's corporate and registered office is located in Vidyut Bhawan, Saharanpur Road, Majra, Dehradun, next to the ISBT Crossing.

## **2.6. *About Central Board of Irrigation & Power (CBIP)***

The Government of India established the Central Board of Irrigation and Power in 1927, making it a Premier Institution. For the past 93 years, CBIP has provided committed services to the nation's professional associations, engineers, and individuals involved in the power, water resources, and renewable energy sectors. While serving the country equally and to great honour, CBIP has developed into an esteemed institution of international significance. CBIP is Indian chapter for 10 international organizations related to Power & Water resources sectors.

CBIP is involved in executing various activities such as, International Conferences, Technical Documents Publications, Training Activities, Research & Development, Consultancy Services including Technical, Protection & Safety Audits.

### 3.0. Preliminary Audit of Kashipur Substation

#### 3.1. General Information about Substation

Sl. No.	Particulars	Details
1	Substation Name	400/220/132/33KV Kashipur Substation
2	Name of Owner Utility	Power Transmission Corporation of Uttarakhand Limited (PTCUL)
3	Voltage Level (s) or highest voltage level	400/220/132KV
4	Short circuit current rating of all equipment (for all voltage level)	400KV = 50KA/3 secs, 220KV = 40KA/sec, 132KV = 31.5KA/sec
5	Date of commissioning of the substation	13 <sup>th</sup> November 2006
6	Checking and validation date	27 <sup>th</sup> – 29 <sup>th</sup> January 2024

#### 3.2. Audit Team

**Audit Team (CBIP):**

- Mr. Vijay Barthwal
- Mr. M.R. Chauhan
- Mr. Rounak Sen

**PTCUL Representative:**

- Mr. Asim Baig – Executive Engineer
- Mr. Ashutosh Pokhriyal – Assistant Engineer
- Mr. Naveen Chandra Pandey – Junior Engineer

### ***3.3. Recommendation of last protection checking and validation***

As per the information received, previous protection audit was carried out by NRPC, dated: 27<sup>th</sup> July 2015.

**a. Following observation were recorded during previous audit**

<b>Sl. No.</b>	<b>Observations</b>	<b>Recommended action</b>
<b>1</b>	67N protection is not available / enabled in the lines / relays (except for 400KV Roorkee and Bareilly lines) as mentioned in General Remarks.	As per Model Relay Setting Guidelines, it is recommended to enable 67N in Main-1 & Main-2 relays.
<b>2</b>	VT fuse failure is disabled for 220KV Pantnagar-2 line	It is recommended to activate the VT fuse failure function in order to block distance protection from operating falsely.
<b>3</b>	Carrier aided scheme is not active for 220KV Pantnagar-2 and Mahuakheraganj lines	It is recommended to rectify faults in the carrier scheme operation by replacing proper PLCC equipment.
<b>4</b>	It is observed that only single stage CBF protection is used for tripping of boundary breakers in case of all line feeders except 400KV Roorkee and Bareilly feeders.	As per model relay setting guidelines it is recommended to provide two stage CBF protection first for re-tripping own CB and second for boundary CBs.
<b>5</b>	220KV Busbar protection is defective.	It is recommended for 220KV busbar protection should be replaced by duplicate busbar numerical relays as per CBIP guidelines.
<b>6</b>	Remote indication of WTI and OTI for certain ICT is defective (refer "general remarks" section point 3 and 7 for more details)	It is recommended to replace faulty Digital Winding temperature indicators so as to ensure proper monitoring of operation of transformers from the control room itself.

Sl. No.	Observations	Recommended action
7	Only single source of LVAC supply is available via 33KV feeder for the auxiliary load consumption in the substation.	It is recommended that two sources shall be made available for LVAC system.
8	Fire protection trip for ICTs	As per CBIP 296, where fire protection is provided the contacts of emulsifier system shall be used to trip main breakers of ICTs. Such scheme is not present here and is necessary.
9	Pole discrepancy timer settings for ICT feeders are kept quite high.	The minimum settings of 0.5 sec is advisable in case of transformer feeders for adequate protection from system unbalancing.

### ***3.4.Review of existing settings at substation***

- a. Utility has provided relay settings adopted for various feeders and transformers.
- b. The record of different relay setting calculations is not available at the substation level.
- c. All relays are numeric, therefore, as per internal protocol of utility relays are tested only at the time of commissioning/change in setting. Copy of test reports not available at substation level.

### ***3.5.Disturbance Recorder availability for the last 6 tripping's***

- a. Utility is submitting Disturbance Recorder data for Inter-State Line 220KV Rudrapur-Bareilly Line to NRLC Portal. The record is not maintained at substation level.
- b. For transformers and Intra-state lines DR data is taken at station level for analysis purpose, utility shall be submitting same with tripping analysis report.

### ***3.6. Chronic reason of tripping, if any***

- a. Based on list of tripping submitted by utility for last 12 months, it is noticed that 2 spurious trippings have taken place.
  - On 27/12/2022, 400 kV Bareilly – I tripped due to malfunction of 86 relay due to rebooting of distance protection at Kashipur and sending the direct trip to remote sub-station.
  - On 29/08/23, 220/132 kV Transformer – 1 tripped due to gantry flashover. At that time a drone operation was noticed in nearby area and is suspected that some identified activity due to drone operation has caused this tripping.
- b. For 132 kV lines, remote end flags are generally not recorded.
- c. On 12/01/2023, the conductor of wave trap at 132 kV Kashipur-Kashipur Circuit -2 tripped. No tripping observed at remote end, but 132 kV Kashipur-Kashipur Circuit -1 tripped from this end on zone 3 to isolate the fault.
- d. In most of the cases, Transient Earth Faults are reported.

### ***3.7. Major non-conformity/deficiency observed***

- a. Bus Bar Protection on all 3 levels i.e. 400KV, 220KV and 132KV level is installed recently and commissioning is underway. For 400KV stability test is to be done, while for other 2, CT cabling from switchyard is pending.
- b. REL551 for SEPL line is not connected to time synchronization due to non-availability of port.
- c. SAS has been commissioned. 220 /132KV transformer -3 data is not integrated with SAS. Also, the upcoming line, for which bay is ready, needs to be incorporated.
- d. Both the 220V DC systems are showing earth-fault.
- e. Emergency DG set operation is in manual mode
- f. The events are recorded from individual relays either directly or thru SAS. no separate Event Logger is provided. SAS output is not accessible either on printer or network or external disks. The output is taken as photographic image.
- g. Recommended relay settings with supporting calculations/ parameters needs to be kept at sub-station.
- h. All the isolators are operated manually. The AC and DC system needs to be checked during maintenance to avoid earth faults in auxiliary system.



- i. 132KV breakers are of old vintage and cause problem during operations.
- j. In case of successful auto reclosures, the information is recorded in log book, but no listing/analysis is kept.
- k. For switchyard protection, lightening masts are provided for 220KV and 132KV area, along with shielding wires. For 400KV area, only shielding wire is provided.

## 4.0. List of Trippings

Name of Feeder/TF	Type of relay/scheme	Date and Time of tripping	Date and Time of closing	Flag observed	Other end flags	Affected load/generation	Analysis of tripping	Action Taken
132 KV Ramnagar	Schneider P645	11.10.23 at 03.43 Hrs	11.10.23 at 04.14Hrs	Dist-9.329 Kms, Zone1, Fault Loop L2-N, IL2= 6.102KA, In= 5.749KA.	No trip at other end	NIL	TLF	NIL
	Schneider P645	24.10.23 at 02.50 Hrs	24.10.23 at 03.03 Hrs	Dist- 3.75 Kms, Zone1,Fault Loop L1-N, IL1= 9.37 KA, In= 9.09 KA.	No trip at other end	NIL	TLF	NIL
	Schneider P645	27.10.23 at 01.57 Hrs	27.10.23 at 02.05 Hrs	Dist- 5.428Kms,zone 1, Fault Loop L2-N, IL2= 8.135 KA, In= 7.824 KA.	No trip at other end	NIL	TLF	NIL
220 Mahuakheraganj	Siemens 7SA522	06-09-2023 10:56hrs	06-09-2023 11:28hrs	Distance trip, distance - 14.28km, fault current-IL1-4594.79A, IN-2491.9A	NA	NIL	Tripped due to Ct burst of TBC at Mahukhera s/s and Busbar operated at Mahuakheraganj s/s.	NIL
400KV Roorkee ckt 1st	Micom p444	07-09-2023 3:27hrs	07-09-2023 14:50hrs	Distance trip zone 1, R phase fault, fault distance-14.93km, fault current IR-10.93KA.	NA	NIL	TLF	NIL
132KV Jaspur line	Micom P545	11-09-2023 6:18hrs	11-09-2023 19:27hrs	Distance trip zone 1, R phase fault, fault distance-	Distance trip zone1, R phase fault, fault	NIL	line R phase LA Burst at jaspur S/s end.	NIL

Name of Feeder/TF	Type of relay/scheme	Date and Time of tripping	Date and Time of closing	Flag observed	Other end flags	Affected load/generation	Analysis of tripping	Action Taken
				14.29km, fault current IR-4.734KA, IN-4.738KA.	location-1.005km, fault current Ia-476A, Ib-534.2A, Ic-279.9A, In-1.111KA			
220KV Pantnagar line	Micom P545/ABBR EL670	27-09-2023 1:17hrs	27-09-2023 11:52hrs	Distance trip zone1, fault loop-L3N, fault distance-15.59km, fault current IL1-144.7A, IL2-169.4A, IL3-3.797KA, IN-3.776KA,	Distance trip zone2, fault loop-L3N, fault distance-62.4km, fault current IL1-21A, IL2-2,49A, IL3-2.25KA, IN-2.26KA,	NIL	TLF	NIL
132KV Rammagar line (line length-23.5km)	Micom p545	11-08-2023 09:53hrs	11-08-2023 10:28hrs	Circuit breaker auto trip,C.B. pole discrepancy trip, zone 1 trip, R phase trip, distance-6.960km,fault current IL1-6.798KA,IN-6.801KA. Va-43.90KV,Vb-74.91KV,Vc-74.19KV,Vn-28.86KV.	other end open.	NIL	TLF	NIL
220KV Pantnagar line (line length-61.94km)	Siemens 7SA522	18-08-2023 3:15hrs	18-08-2023 03:36hrs	Distance trip zone-1, fault loop-L1N, fault location=55.94km, fault current	Distance trip zone-1, fault loop-L1N, fault location=4.2km, fault	NIL	TLF	NIL

Name of Feeder/TF	Type of relay/scheme	Date and Time of tripping	Date and Time of closing	Flag observed	Other end flags	Affected load/generation	Analysis of tripping	Action Taken
				IL1=2.419KA, IN-1.909KA	current IL1-5419A, IL2-241A, IL3-324A, IN-5902A.			
	Siemens 7SA522	22-08-2023 1:42hrs	22-08-2023 01:58hrs	Distance trip zone-1, fault loop-L1N, fault location=15.21km, fault current IL1=6.187KA, IN-6.207KA.	Fault loopL1N, Distance-26.12km, fault current IL1-2.514KA.	NIL	TLF	NIL
132KV Ramnagar line (line length-23.5km)	Micom p545	27-08-2023 5:22hrs	27-08-2023 04:34hrs	Distance trip zone 1, fault loop L1N, Distance-7.58km, IL1-6.465KA, IL2-6.468KA.	other end open.	NIL	TLF	NIL
160MVA T/F 1st	micom p643, micomP143	29-08-2023 8:51hrs	29-08-2023 14:23hrs	Diff protection bias HS1 trip, Ia diff-7.945pu, Ib diff-15.89pu, Ic diff-7.941pu, Ia bias-3.980pu, Ib bias-7.943pu, Ic bias-3.980pu. HV fault current Ia-273.4A, Ib-2.159KA, Ic-134.5A, LV fault current-Ia-451.0A, Ib-13.08KA, Ic-233.3A.	Not applicable	NIL	Tripping due to suspected drone.	Stability test of t/f done and results found satisfactory
132KV Ramnagar line	NA	06-07-2023 5:26hrs	06-07-2023 08:45hrs	Distance trip zone-1, fault loop-L1N, fault location=3.5km,	Other End Open	NIL	Disc broken with conductor	NIL

Name of Feeder/TF	Type of relay/scheme	Date and Time of tripping	Date and Time of closing	Flag observed	Other end flags	Affected load/generation	Analysis of tripping	Action Taken
				fault current IL1=9.7KA, IN-9.7KA				
220KV Pantnagar line	NA	09-07-2023 2:12hrs	09-07-2023 12:39hrs	Distance trip zone-1, fault loop-L2N, fault location=24.62km, fault current IL1=171A, IL2-4.603KA, IL3-129A, IN-4.472KA	Distance trip zone-1, fault loop-L2N, fault location=23.252km, fault current IL2-2722A.	NIL	TLF	NIL
132KV RAMNAGAR	NA	12-06-2023 01:30:00	12-06-2023 01:55:00	Distance trip zone-1, B-phase trip, fault location=107km, fault current IB=842.5A, IN=859.1A	NIL	NIL	TLF	NIL
400KV Bareilly 1	NA	07.05.23/1 4:55hrs	07.05.23/ 16:12hrs	Flags: distance trip, Zone 1 Trip, fault loop-L1L2, Fault distance-89.93kms, IA=2574.71A IB=3081.59A IC=39.40A	Flags: distance trip, fault loop-L1L2, Fault distance-0km IA=27.30KA IB=26.83KA	NIL	From Bareilly s/s end at tower number 1 flash over seen b/w phase 'R' and 'Y'.	NIL
132KV Ramnagar ckt	Micom 543	12-03-2023 10:58HRS	12-03-2023 11:15HRS	Distance trip zone Z1, Distance-13.1km, fault current IL1-0.96KA, IL2-0.11KA,IL3-0.14KA.	Distance trip, Zone- 1 trip, distance-8.66km, fault current IL1-5.85KA, IL2-139A, IL3-107A.	NIL	TLF	LEFT

Name of Feeder/TF	Type of relay/scheme	Date and Time of tripping	Date and Time of closing	Flag observed	Other end flags	Affected load/generation	Analysis of tripping	Action Taken
132KV Kashipur ckt-1	Micom 543	31-03-2023 12:17 HRS	31-03-2023 19:28HRS	Broken conductor trip, fault current IL1-205.8A, IL2-0.00A, IL3-205.9A, IN-139.5A, Va fault-78.29KV, Vb-76.85KV, Vc-78.15KV, Vn-2.802KV.	Broken Conductor Trip	NIL	Broken conductor trip	LEFT
400KV Bareilly ckt-2	ABB, Schneider	12-02-2023 11:55 Hrs	12-02-2023 12:52 Hrs	Distance trip, Fault Loop-L2-L3, Distance - 87.18Km, Fault Current IL1-650.04A, IL2-3485.05A, IL3-3827.82A	Distance trip, Fault Loop-L2-L3, Distance - 8.2Km, Fault Current IL2-21.5KA, IL3-20.9KA	NIL	T/F	NA
132KV Kashipur ckt-1	Schneider	17-01-2022 13:23 HRS	17-01-2022 13:59HRS	Distance trip, fault loop-L1-N, Zone- 3 trip, fault current IL1-63.88A, IL2-384.5A, IL3-263.1A, IN-277.6A.	NA	NIL	T/F	NA
132KV Kashipur ckt-2	Schneider	17-01-2022 13:23 HRS	17-01-2022 17:55HRS	distance trip, fault loop-L1-N, Zone- 1 trip, fault distance- 1.198km, fault current IL1-8.705KA, IL2-335.5A, IL3-304.1A, IN-8.682A.	NA	NIL	Conductor broken from wave trap at 132KV Kashipur S/s switchyard.	NA

Name of Feeder/TF	Type of relay/scheme	Date and Time of tripping	Date and Time of closing	Flag observed	Other end flags	Affected load/generation	Analysis of tripping	Action Taken
132KV Kashipur ckt-1	Schneider	19-12-2022 05:43 HRS	19-12-2022 08:33HRS	Distance trip, Zone- 1 trip, distance-836.9m, fault current IL1-8.8909KA, IN-8.860KA	Distance trip, Zone- 2 trip, distance-2.674km, fault current IL1-3874.6A, IL2-282.56A, IL3-247.11A	NIL	T/F	NA
132KV Kashipur ckt-2	Schneider	19-12-2022 06:12 HRS	19-12-2022 06:28HRS	O/C&E/F trip, fault current IA-382A, IB-392A, IC-398A	NA	NIL	T/F	NA
400KV ckt-1	Schneider	27-12-2022 23:57 HRS	28-12-2022 22:14HRS	Fault current IL1-.95A, IL2-1.02A, IL3-340A, IN-6.80A	DT trip	NA	Tripping due rebooting of distance relay & malfunctioning and 86 relay faulty	NA
400KV Barielly ckt-1	Schneider	30-12-2022 12:19 HRS	Line is still in breakdown	Distance trip, Zone- 1 trip, distance-996.6m, fault loop-L2-L3, fault current IL1-1.39KA, IL2-11.24KA, IL3-12.47KA	NA	NIL	Broken conductor	NA

## 5.0. Observations and Recommendations

### 5.1. Reporting of all the Tripping with DR/EL

- a. For the interstate lines, as per IEGC clause 37.2(c) and clause 15.3 of CEA grid standard, all the DR/EL reports shall be uploaded on Web Based Tripping Monitoring System “http://103.7.128.184/Account/Login.aspx” within 24 hours of the events. These are being submitted by sub-station to NRLDC portal, however the record of the same is not kept at sub-station level.

Status of submission of FIR/DR/EL/Tripping Report on NR Tripping Portal																						
Time Period: 1st January 2024 - 31st January 2024																						
S. No.	Utility	Total No. of tripping	First Information Report (Not Received)		Disturbance Recorder (Not Received)		Disturbance Recorder (NA) as informed by utility		Event Logger (Not Received)		Event Logger (NA) as informed by utility		Event Logger (Not Received)		Tripping Report (Not Received)		Tripping Report (NA) as informed by utility		Tripping Report (Not Received)		Remark	
			Value	%	Value	%	Value	%	Value	%	Value	%	Value	%	Value	%						
36	SLDC-PS	28	2	7	13	6	57	13	5	54	16	0	55									
37	SLDC-RS	130	12	9	23	11	19	23	9	19	39	0	38	DR, EL & Tripping report need to be submitted								
38	SLDC-UK	6	0	0	0	4	0	0	4	0	1	3	33									
39	SLDC-UP	80	10	13	11	9	15	12	10	17	11	1	14									
40	STERLITE	1	0	0	0	0	0	0	0	0	0	1	0	Details received								
41	TANAKPUR-NH	4	1	25	1	0	25	1	0	25	1	0	25	DR, EL & Tripping report need to be submitted								
42	LUNCHHAR-NT	1	0	0	0	0	0	0	1	0	0	0	0	Details received								
Total in NR Region		520	147	28	169	69	37	171	70	38	185	17	37									

As per the IEGC provision under clause 37.2 (c), detailed tripping report along with DR & EL has to be furnished within 24 hrs of the occurrence of the event

Ref: NRPC 216 OCC Agenda (Annexure B.VIII)

- b. For the tripping of intra-state lines, the brief tripping reports are submitted to Divisional office. The DR/EL reports are downloaded by respective officials and forwarded, as per need basis. The record of these DR/EL is not kept at sub-stations
- c. It is recommended that each sub-station to have a central repository of such tripping reports, along with DR/EL reports and analysis. A dedicated PC can be kept for this.

### 5.2. Development of centralized database of relay settings

- a. In 48th TCC & 70th NRPC Meeting (held on 17-18 Nov 2023), NRPC Committee has approved for development of a portal through PSDF for Centralized database containing details of relay settings for grid elements connected to 220 KV and above. Portal shall have other features including protection setting calculation tool. A nodal officer shall be providing this data at central portal.



- b. The relay settings for below 220KV are to be calculated by SLDC and/or central level. The relays are tested by sub-station officials as per need basis, but the record of recommended settings/ calculation is not kept at sub-station level. This makes it difficult to validate the settings and test results, in case of relay testing.
- c. It is recommended that latest recommended relay settings, as decided by RLDC for 220KV & above and by SLDC below 220KV along with setting calculations & parameters used for all the relays be kept at sub-station level. This will help in proper fault analysis and ascertaining relay healthiness.

### **5.3. *Review of test results of relay and equipment***

- a. Testing of most of the equipment is carried out, as per availability of shut-down and testing equipment. After testing, the test records are summarily recorded in testing register, with remarks as “tested. OK”.
- b. For the numeric relay testing, the testing is carried out by supplier at the time of installation and subsequently as per need basis, including at the time of change in settings.
- c. A draft O&M manual is available at PTCUL web-site, which includes various tests and their frequency, along with results. This manual is based on CERC/SERC regulations of 2004-2008. It is recommended that this manual may be updated and implemented and record of test values may be kept for future reference.

### **5.4. *Availability of Testing Kits***

- a. The availability of testing equipment is limited at each substation. For comprehensive testing of equipment, as per above para, sufficient testing kits at each substation/Sub-division/ Division level are required.
- b. Based on the O&M manual, it is recommended that sufficient quantity of testing instruments be made available at sites for regular testing of equipment. A suggested list of Testing Equipment is attached at Annexure – 1.

### **5.5. *Up-dation of PTCUL Protection Philosophy***

The protection philosophy adopted by Utility, in general, is in alignment with protection philosophy adopted by NRPC. As the NRPC has recently updated the protection philosophy,

PTCUL in consultation with SLDC may update protection philosophy for network not covered by NRPC, if needed, and implement the same.

#### **5.6. *Simulation based study of protection system***

As per IEGC, protection code, during audit the relay settings to be adopted shall be validated with simulation based or EMTP studies and details shall be enclosed in report. The current scope of audit was excluding these studies, therefore, Simulation based or EMTP Studies should be carried out by the Utility, as per the requirement of Grid Code.

#### **5.7. *Capacity Building of protection team***

During the discussions with officials at site, it was observed that the teams responsible for the protection system and SAS, needs to be updated on current trends on protection system, communication schemes and Sub-station automation. Utility may undertake capacity building exercise for the officials involved in these activities.

#### **5.8. *Updated Fault Level/ Short Circuit Level and Network information***

The fault level/ short circuit level for each substation is being calculated at central level. Such studies are carried out, as and when new elements are added in the network. This has impact on relay settings parameters and equipment ratings. It is recommended that the updated network information and short circuit level be maintained at central level for revising the setting as per requirement.

#### **5.9. *General Protection related observations***

The study of Fire protection system/ Nitrogen Injection Fire Protection System, Lightning Protection system, Earthing Mat/ Earthing Protection are not covered under protection audit. Utility may get a comprehensive technical and safety audit carried out internally or thru third party and corrective action for any discrepancy be taken up accordingly.

#### **5.10. *O&M Manual***

The Utility has a draft O&M manual uploaded on its website, which is being referred by working level officials as a guideline for regular O&M and testing functions. This manual needs to be updated to incorporate recent developments and approved for regular use in all sub-stations to bring uniformity in O&M and testing practices across the utility.

## 6.0. Station Specific Observation and Recommendations

### 6.1. Protection related observations and recommendations

- a. Last protection audit was carried out on 27 July 2015. Many of the observations are not complied so far or has reoccurred since then. It is recommended to keep the previous audit report(s) and compliance status updated.
- b. Based on analysis of line tripping during last 12 months, it is observed that in most of the cases, the cause of tripping is Transient Earth Fault. For tripping at 132kV side, remote end flags are not recorded. On 12.01.2023, 132 kV Kashipur – Kashipur -2 tripped on zone 1 and 132 kV Kashipur – Kashipur - 1 tripped on zone 3 for fault at wave trap of Kashipur-Kashipur-2 at this end. No tripping was observed at remote end. The record of relay flag operation for remote end needs to be maintained and this tripping needs to be investigated for proper relay settings at 132 kV side.
- c. Bus Bar Protection panels for all 3 levels i.e. 400KV, 220KV and 132KV level is installed recently and commissioning is underway. For 400KV stability test is pending. For 220kV and 132 KV Cables from CT in the switchyard are to be laid. The status of commissioning of 400kV bus Bar protection needs to be updated and for 220 kv and 132 kV commissioning work to be expedited.
- d. The events are recorded from individual relays either directly or thru SAS. no separate Event Logger is provided. SAS output is not accessible either on printer or network or external disks. The output is taken as photographic image. SAS has been commissioned. 220 /132KV transformer -3 data is not integrated with SAS. Also, the upcoming line, for which bay is ready, needs to be incorporated. It is recommended that SAS be updated as and when any change occurs and kept functional.
- e. REL551 for SEPL line is not connected to time synchronization due to non-availability of port. Corrective action needs to be taken.

## **6.2. *Equipment related observations and recommendations***

PTCUL has submitted a list of switchyard equipments to be replaced under PSDF funding, as per Annexure - 2. In view of the need of modern sub-stations, where automation of sub-station is of paramount importance, these replacements are required. Based on the specifications and healthiness of existing equipments, the list may be reviewed by PTCUL.

In addition, it is recommended that sufficient quantity of maintenance equipments be made available at sites. A suggested list of **Maintenance Equipment is attached at Annexure – 3.**

## **6.3. *Auxiliary Equipment related observations and recommendations***

- a. Both the 220V DC systems are showing severe earth-fault. The necessary corrective action needs to be taken asap to avoid any unwanted tripping in future.
- b. Emergency DG set operation is in manual mode. Necessary action may be taken to keep the DG set in Auto mode.

## Annexure – 1: Suggested List of Testing Instruments

CBIP suggests the following list of testing instruments based on the approved O&M manual

Sl. No.	Testing Instruments
1	DCRM for Circuit Breaker
2	DC Earth Fault Locator
3	SF6 Gas Density Monitor
4	SF6 Gas Leakage detector/ Imaging Camera
5	CB Analyser
6	Earth Resistance Tester
7	Portable Digital Selective Level Meter cum Level Generator
8	Selective Level Generator
9	LA Leakage Current Analyser
10	Digital Multi-meter
11	Tong Tester
12	Tan Delta Test Kit
13	Digital Leakage Clamp Meter
14	Phase Sequence Indicator
15	Megger (5 kV)
16	Digital Capacitance Meter
17	CT Polarity Tester
18	PT Test Set

## Annexure – 2: Suggested List of Substation Equipments

The suggested list of Substation Equipments keeping in mind the necessity for the modernization and upgradation of substations.

Sl. No.	Equipment	Unit	Quantity
<b>A</b>	<b>400KV Equipment</b>		
1	420KV Current Transformer 1 phase	Nos	30
2	420KV CVT 1 phase	Nos	15
<b>B</b>	<b>220KV Equipment</b>		
1	245KV Current Transformer (5 Core), Class 0.2s (1ph) 1000/500/1	Nos	12
2	245KV Current Transformer (5 Core), Class 0.2s (1ph) 1600/800/1	Nos	30
3	245KV CVT 1 Ph	Nos	18
<b>C</b>	<b>132KV Equipment</b>		
1	145KV Circuit Breaker 3PH	Nos	8
2	145KV Current Transformer 1Ph	Nos	30
3	145KV CVT	Nos	18
4	145KV HYBRID Plug and switch system (PASS) Including breaker and disconnecter at both end for 132 kV Main & Transfer Bus	Nos	2
<b>D</b>	<b>33KV Equipment</b>	Nos	0
1	33KV Circuit Breaker	Nos	2
2	33KV Isolator 3Ph	Nos	6
3	33KV Surge Arrestor 1 Ph (polymer)	Nos	6

### Annexure – 3: Suggested List of Maintenance Equipments

Sl. No.	Equipment
1	Oil Filter Machine
2	SF6 Gas Handling Plant
3	SF6 Gas Density Monitor
4	Thermo-Vision Camera Lines and Sub-Station
5	Binocular Vision Camera
6	SF6 Gas Leakage Imaging Camera
7	LA Leakage Current Analyser
8	Online DGA
9	Oil BDV Kit
10	Hydraulic Crimping Tool for different Types of ACSR Conductor
11	Hydraulic Conductor Cutter
12	Fork Lift 5 Ton Capacity
13	Digital Leakage Clamp Meter

A mobile van with test kits can be kept for optimizing the resources at various substations

## Annexure – 4: Protection Code (IEGC 2023 Chapter 4)

- **General**

1. This chapter covers the protection protocol, protection settings and protection audit plan of electrical systems.
2. There shall be a uniform protection protocol for the users of the grid:
  - a) for proper co-ordination of protection system in order to protect the equipment/system from abnormal operating conditions, isolate the faulty equipment and avoid unintended operation of protection system;
  - b) to have a repository of protection system, settings and events at regional level;
  - c) specifying timelines for submission of data;
  - d) to ensure healthiness of recording equipment including triggering criteria and time synchronization; and
  - e) to provide for periodic audit of protection system.

- **Protection protocol**

1. All users connected to the integrated grid shall provide and maintain effective protection system having reliability, selectivity, speed and sensitivity to isolate faulty section and protect element(s) as per the CEA Technical Standards for Construction, the CEA Technical Standards for Connectivity, the CEA (Grid Standards) Regulations, 2010, the CEA Technical Standards for Communication and any other applicable CEA Standards specified from time to time.
2. Back-up protection system shall be provided to protect an element in the event of failure of the primary protection system.
3. RPC shall develop the protection protocol and revise the same, after review from time to time, in consultation with the stakeholders in the concerned region, and in doing so shall be guided by the principle that minimum electrical protection functions for equipment connected with the grid shall be provided as per the CEA Technical Standards for Construction, the CEA Technical Standards for Connectivity, the CEA Technical Standards for Communication, the CEA (Grid Standards) Regulations, 2010, the CEA (Measures relating to Safety and Electric Supply) Regulations, 2010, and any other CEA standards specified from time to time.



4. The protection protocol in a particular system may vary depending upon operational experience. Changes in protection protocol, as and when required, shall be carried out after deliberation and approval of the concerned RPC.
5. Violation of the protection protocol of the region shall be brought to the notice of concerned RPC by the concerned RLDC or SLDC, as the case may be.

- **Protection settings**

1. RPCs shall undertake review of the protection settings, assess the requirement of revisions in protection settings and revise protection settings in consultation with the stakeholders of the respective region, from time to time and at least once in a year. The necessary studies in this regard shall be carried out by the respective RPCs. The data including base case (peak and off-peak cases) files for carrying out studies shall be provided by RLDC and CTU to the RPCs:
2. All users connected to the grid shall:
  - a) furnish the protection settings implemented for each element to respective RPC in a format as prescribed by the concerned RPC;
  - b) obtain approval of the concerned RPC for,
    - i. any revision in settings, and,
    - ii. implementation of new protection system;
  - c) intimate to the concerned RPC about the changes implemented in protection system or protection settings within a fortnight of such changes;
  - d) ensure correct and appropriate settings of protection as specified by the concerned RPC.
  - e) ensure proper coordinated protection settings.
3. RPCs shall:
  - a) maintain a centralized database and update the same on periodic basis in respect of their respective region containing details of relay settings for grid elements connected to 220KV and above (132KV and above in NER). RLDCs shall also maintain such database.
  - b) carry out detailed system studies, once a year, for protection settings and advise modifications / changes, if any, to the CTU and to all users and STUs of their respective regions. The data required to carry out such studies shall be provided by RLDCs and CTU.

- c) provide the database access to CTU and NLDC and to all users, RLDC, SLDCs, and STUs of the respective regions. The database shall have different access rights for different users.
4. The changes in the network and protection settings of grid elements connected to 220KV and above (132KV and above in NER) shall be informed to RPCs by CTU and STUs, as the case may be.

The elements of network below 66KV and radial in nature which do not impact the National Grid may be excluded as finalized by the respective RPC.

- **Protection audit plan**

1. All users shall conduct internal audit of their protection systems annually, and any shortcomings identified shall be rectified and informed to their respective RPC. The audit report along with action plan for rectification of deficiencies detected, if any, shall be shared with respective RPC for users connected at 220KV and above (132KV and above in NER).
2. All users shall also conduct third party protection audit of each substation at 220KV and above (132KV and above in NER) once in five years or earlier as advised by the respective RPC.
3. After analysis of any event, each RPC shall identify a list of substations / and generating stations where third-party protection audit is required to be carried out and accordingly advise the respective users to complete third party audit within three months.
4. The third-party protection audit report shall contain information sought in the format enclosed as Annexure-1. The protection audit reports, along with action plan for rectification of deficiencies detected, if any, shall be submitted to the respective RPC and RLDC or SLDC, as the case may be, within a month of submission of third-party audit report. The necessary compliance to such protection audit report shall be followed up regularly in the respective RPC.
5. Annual audit plan for the next financial year shall be submitted by the users to their respective RPC by 31<sup>st</sup> October. The users shall adhere to the annual audit plan and report compliance of the same to their respective RPC.
6. Users shall submit the following protection performance indices of previous month to their respective RPC and RLDC on monthly basis for 220KV and above (132KV and above in NER) system, which shall be reviewed by the RPC:
  - a. The Dependability Index defined as

$$D = \frac{Nc}{Nc+Nf}$$

where,

$N_C$  is the number of correct operations at internal power system faults and

$N_f$  is the number of failures to operate at internal power system faults.

- b. The Security Index defined as

$$S = \frac{Nc}{Nc+Nu}$$

where,

$N_C$  is the number of correct operations at internal power system faults

$N_U$  is the number of unwanted operations.

- c. The Reliability Index defined as

$$R = \frac{Nc}{Nc+Ni}$$

where,

$N_C$  is the number of correct operations at internal power system faults

$N_i$  is the number of incorrect operations and is the sum of  $N_f$  and  $N_u$

7. Each user shall also submit the reasons for performance indices less than unity of individual element wise protection system to the respective RPC and action plan for corrective measures. The action plan will be followed up regularly in the respective RPC.
8. In case any user fails to comply with the protection protocol specified by the RPC or fails to undertake remedial action identified by the RPC within the specified timelines, the concerned RPC may approach the Commission with all relevant details for suitable directions.

- **System Protection Scheme (SPS)**

1. SPS for identified system shall have redundancies in measurement of input signals and communication paths involved up to the last mile to ensure security and dependability.
2. For the operational SPS, RLDC or NLDC, as the case may be, in consultation with the concerned RPC(s) shall perform regular load flow and dynamic studies and mock testing for reviewing SPS parameters & functions, at least once in a year.
3. RLDC or NLDC shall share the report of such studies and mock testing including any short comings to respective RPC(s). The data for such studies shall be provided by CTU to the concerned RPC, RLDC and NLDC.
4. The users and SLDCs shall report about the operation of SPS immediately and detailed report shall be submitted within three days of operation to the concerned RPC and RLDC in the format specified by the respective RPCs.
5. The performance of SPS shall be assessed as per the protection performance indices specified in these Regulations. In case, the SPS fails to operate, the concerned User shall take corrective actions and submit a detailed report on the corrective actions taken to the concerned RPC within a fortnight.

- **Recording instruments**

1. All users shall keep the recording instruments (disturbance recorder and event logger) in proper working condition.
2. The disturbance recorders shall have time synchronization and a standard format for recording analogue and digital signals which shall be included in the guidelines issued by the respective RPCs.
3. The time synchronization of the disturbance recorders shall be corroborated with the PMU data or SCADA event loggers by the respective RLDC. Disturbance recorders which are non-compliant shall be listed out for discussion at RPC.

## **Annexure – 5: Third Party Protection System Checking & Validation Template for a Substation (IEGC 2023 Annexure – 1)**

### **1. Introduction:**

- a. The audit reports, along with action plan for rectification of deficiencies found, if any, shall be submitted to RPC or RLDC within a month of submission of report by auditor.
- b. The third-party protection system checking shall be carried at site by the designated agency. The agency shall furnish two reports:
  - i. Preliminary Report: This report shall be prepared on the site and shall be signed by all the parties present.
  - ii. Detailed Report: This report shall be furnished by agency within one month after carrying out detailed analysis.

### **2. Checklist:**

- a. The protection system checklist shall contain information as per this Regulation.
  - i. General Information (to be provided prior to the checking as well as to be included in final report):
    - Substation name
    - Name of Owner Utility
    - Voltage Level (s) or highest voltage level
    - Short circuit current rating of all equipment (for all voltage level) (v) Date of commissioning of the substation
    - Checking and validation date
    - Record of previous tripping's (in last one year) and details of protection operation
    - Previous Relay Test Reports
    - Overall single line diagram (SLD) (x) AC aux SLD
    - DC aux SLD
    - SAS architecture diagram
    - SPS scheme implemented (if any)

b. The preliminary report shall inter-alia contain the following:

**FORMAT OF PRELIMINARY REPORT**

S. No.	Issues	Remarks
<b>1</b>	Recommendation of last protection checking and validation	Status of works & pending issues if any
<b>2</b>	Review of existing settings at substation	Recommended Action
<b>3</b>	Disturbance Recorder out/ available for last 6 trippings (Y/N)	Recommended Action
<b>4</b>	Chronic reason of tripping, if any	Recommended Action
<b>5</b>	Major non-conformity/deficiency observed	Recommended Action

c. The **relay configuration check-list** for available power system elements at station:

- Transmission Line
- Bus Reactor/Line Reactor
- Inter-connecting Transformer
- Busbar Protection Relay
- AC auxiliary system
- DC auxiliary system
- Communication system
- Circuit Breaker Details
- Current Transformer details
- Capacitive Voltage Transformers Details
- Any other equipment/system relevant for protection system operation

d. The **minimum set of points on which checking & validation** shall be carried out is covered in this clause. The detailed list shall be prepared by checking and validation team in consultation with concerned entity, RLDC and RPC.

**i. Transmission Line Distance Protection/Differential Protection;**

- Name and Length of Line
- Whether series compensated or not
- Mode of communication used (PLCC/OPGW)

- Relay Make and Model for Main-I and Main-II
- List of all active protections & settings
- Carrier aided scheme if any
- Status of Power Swing/Out of Step/SOTF/Breaker Failure/Broken Conductor/STUB/Fault Locator/DR/VT fuse fail/Overvoltage Protection/Trip Circuit supervision/Auto-reclose/Load encroachment etc.
- Relay connected to Trip Coil-1 or 2 or both i. CT ratio and PT ratio
- Feed from DC supply-1 or 2
- Connected to dedicated CT core (mention name)
- Other requirements for protection checking and validation

**ii. Shunt Reactor & Inter-connecting Transformer (ICT) Protection;**

- Whether two groups of protections used (Group A and Group B)
- Do the groups have separate DC sources
- Relay Make and Model
- List of all active protections along with settings
- Status of Differential Protection/Restricted Earth Fault Protection/Back-up Directional Overcurrent/Backup Earth fault/ Breaker Failure
- Status of Oil Temperature Indicator/Winding-Temperature Indicator/Bucholz/Pressure Release Device etc.
- Relay connected to Trip Coil-1 or 2 or both
- CT ratio and PT ratio
- Feed from DC supply-1 or 2
- Connected to dedicated CT core (mention name)
- Other requirements for protection checking and validation

**iii. Busbar Protection Relay;**

- Busbar and redundant relay make and model
- Type of Busbar arrangement
- Zones
- Dedicated CT core for each busbar protection (Yes/No)
- Breaker Failure relay included (Yes/No), if additional then furnish make and model
- Trip issued to both Busbar protection in case of enabling
- Isolator indication and check relays

- Other requirements for protection checking and validation

**iv. AC auxiliary system;**

- Source of AC auxiliary system
- Supply changeover between sources (Auto/Manual)
- Diesel generator (DG) details
- Maintenance plan and supply changeover periodicity in DG
- Single Line Diagram
- Other requirements for protection checking and validation

**v. DC auxiliary system;**

- Type of Batteries (Make, vintage, model)
- Status of battery Charger
- Measured voltage (positive to earth and negative to earth)
- Availability of ground fault detectors
- Protection relays and trip circuits with independent DC sources
- Other requirements for protection checking and validation
- Communication system
  - Mode of communication for Main-1 and Main-2 protection
  - Mode of communication for data and speech communication
  - Status of PLCC channels
  - Time synchronization equipment details
  - 7OPGW on geographically diversified paths for Main-1 and main-2 relay
  - Other requirements for protection checking and validation

**vi. Circuit Breaker Details;**

- Details and Status
- Healthiness of Tripping Coil and Trip circuit supervision relay
- Single Pole/Multi pole operation
- Pole Discrepancy Relay available (Y/N)
- Monitoring Devices for checking the dielectric medium
- Other requirements for protection checking and validation
- Current Transformer (CT)/Capacitive Voltage Transformer (CVT) Details
  - CT/CVT ID name and voltage level



- CT/CVT core connection details
- Accuracy Class
- Whether Protection/Metering
- CT/CVT ratio available and ratio adopted
- Details of last checking and validation of CT/CVT healthiness
- Other requirements for protection checking and validation
- Other protections: Direction earth fault, negative sequence, over current, over voltage, over frequency, under voltage, under frequency, forward power, reverse power, out of step/power swing, HVDC protection etc.

### 3. Summary of checking:

The summary shall specifically mention minimum following points:

- a) The settings and scheme adopted are in line with agreed protection philosophy or any accepted guidelines (e.g. Ramakrishna guidelines or CBIP manual based).
- b) The deviations from the RPC protection philosophy, if any and reasons for taking the deviations shall be recorded.
- c) All the major general deficiency shall be listed in detail along with remedial recommendations.
- d) The relay settings to be adopted shall be validated with simulation based or EMTP studies and details shall be enclosed in report.
- e) The cases of protection maloperation shall be analysed from protection indices report furnished by concerned utility, the causes of failure along with corrective actions and recommendations based on the findings shall be noted in the report.

## Annexure – 6: Protection Philosophy/Protocol of Northern Region

The Protection Philosophy/Protocol of Northern Region is developed in compliance of IEGC 2023, Version 2.0 which was approved in 71<sup>st</sup> NRPC meeting held on 29.01.2024.

S.N.	Protection Setting/Protocol	Mandated Setting for transmission lines
1	<b>Protection Scheme</b>	<p>220KV and above: Independent Main-I and Main-II protection (of different make OR different type/different algorithm) of non-switched numerical type is to be provided with carrier aided scheme.</p> <p>132KV and below: One non-switched distance protection scheme and, directional over current and earth fault relays, should be provided as back up.</p>
2	<b>Distance Protection Zone-1</b>	<p>Reach: 80% of the protected line; 110% of the protected line (In case of radial lines) Time Setting: Instantaneous.</p>
3	<b>Distance Protection Zone-2</b>	<p>Reach: Single Circuit Line: 120% of length of principle line section. Double circuit line: 150% coverage of line to take care of under reaching due to mutual coupling effect.</p> <p>Time setting: i. 0.35 second <i>(considering LBB time of 200mSec, CB open time of 60ms, resetting time of 30ms and safety margin of 60ms)</i> ii. 0.5-0.6 second <i>(For a long line followed by a short line)</i></p>

S.N.	Protection Setting/Protocol	Mandated Setting for transmission lines
4	<b>Distance Protection Zone-3</b>	<p>Reach: Zone-3 should overreach the remote terminal of the longest adjacent line by an acceptable margin (typically 20% of highest impedance seen) for all fault conditions.</p> <p>Time Setting: 800-1000 msec</p> <p>If zone-3 reach transcends to other voltage level, time may be taken up to 1.5 sec.</p>
5	<b>Distance Protection Zone- 4</b>	<p>The Zone-4 reverse reach must adequately cover expected levels of apparent bus bar fault resistance.</p> <p>Time may be coordinated accordingly.</p> <p>Where Bus Bar protection is not available, time setting: 160 msec.</p>
6	<b>Lines with Series and other compensations in the vicinity of Substation</b>	<ul style="list-style-type: none"> <li>• Zone-1: FSC end: 60% of the protected line. Time: Instantaneous; Remoted end: 60% of the protected line with 100ms-time delay. POR Communication scheme logic is modified such that relay trips instantaneously in Zone-1 on carrier receive.</li> <li>• Zone-2: 120 % of uncompensated line impedance for single circuit line. For Double circuit line, settings may be decided on basis of dynamic study in view of zero sequence mutual coupling.</li> <li>• Phase locked voltage memory is used to cope with the voltage inversion. Alternatively, an intentional time delay may be applied to overcome directionality problems related to voltage inversion.</li> <li>• Over-voltage stage-I setting for series compensated double circuit lines may be kept</li> </ul>

S.N.	Protection Setting/Protocol	Mandated Setting for transmission lines
		higher at 113%.
7	<b>Power Swing Blocking</b>	<ul style="list-style-type: none"> <li>Block tripping in all zones, all lines.</li> </ul> Out of Step tripping to be applied on all inter-regional tie lines. Deblock time delay = 2s
8	<b>Protection for broken conductor</b>	Negative Sequence current to Positive Sequence current ratio more than 0.2 (i.e. $I_2/I_1 \geq 0.2$ ) Alarm Time delay: 3-20 sec. Tripping may be considered for radial lines to protect single phasing of transformers.
9	<b>Switch on to fault (SOTF)</b>	Switch on to fault (SOTF) function to be provided in distance relay to take care of line energization on fault.
10	<b>VT fuse fail detection function</b>	VT fuse fail detection function shall be correctly set to block the distance function operation on VT fuse failure.
11	<b>Carrier Protection</b>	To be applied on all 220KV and above lines with the only exception of radial feeders.
12	<b>Back up Protection</b>	<ol style="list-style-type: none"> <li>On 220KV and above lines with 2 Main Protections:               <ul style="list-style-type: none"> <li>Back up Earth Fault protections alone to be provided.</li> <li>No Over current protection to be applied.</li> </ul> </li> <li>At 132KV and below lines with only one Main protection:               <ul style="list-style-type: none"> <li>Back up protection by IDMT O/C and E/F to be applied.</li> </ul> </li> </ol>

S.N.	Protection Setting/Protocol	Mandated Setting for transmission lines
13	<b>Auto Reclosing with dead time.</b>	<p>AR shall be enabled for 220KV and above lines for single pole trip and re-closing. Dead time = 1.0s. Reclaim time = 25.0s</p> <p>Auto-recloser shall be blocked for following:</p> <ul style="list-style-type: none"> <li>• Faults in cables</li> <li>• Breaker Fail Relay</li> <li>• Line Reactor Protections</li> <li>• O/V Protection</li> <li>• Received Direct Transfer trip signals</li> <li>• Busbar Protection</li> <li>• Zone 2/3 of Distance Protection</li> <li>• Circuit Breaker Problems.</li> </ul> <p>CB Pole discrepancy relay time:1.5 sec; for tie breaker: 2.5 sec</p>
14	<b>Busbar protection</b>	To be applied on all 220KV and above sub stations with the only exception of 220KV radial fed bus bars.
15	<b>Local Breaker Backup (LBB)</b>	<p>For 220KV and above level substations as well as generating stations switchyards, LBB shall be provided for each circuit breaker.</p> <p>LBB Current sensor <math>I &gt; 20\%</math> In LBB time delay = 200ms</p> <p>In case of variation in CT ratio, setting may be done accordingly.</p>
16	<b>Line Differential</b>	<p>For cables and composite lines, line differential protection with built in distance back up shall be applied as Main-I protection and distance relay as Main-II protection.</p> <p>For very short line (less than 10 km), line differential protection with distance protection as</p>

S.N.	Protection Setting/Protocol	Mandated Setting for transmission lines
		<p>backup (built- in Main relay or standalone) shall be provided mandatorily as Main-I and Main-II.</p> <p>Differential protection may be done using dark fiber (preferably), or using bandwidth.</p>
17	Over Voltage Protection	<p>FOR 765KV LINES/CABLE:</p> <p>Low set stage (Stage-I): 106% - 109% (typically 108%) with a time delay of 5 seconds.</p> <p>High set stage (Stage-II): 140% - 150% with a time delay of 100 milliseconds.</p> <p>400KV LINES/CABLE:</p> <p>Low set stage (Stage-I): 110% - 112% (typically 110%) with a time delay of 5 seconds.</p> <p>High set stage (Stage-II): 140% - 150% with a time delay of 100 milliseconds.</p> <p>FOR 220KV LINES:</p> <p>No over-voltage protection shall be used.</p> <p>FOR 220KV CABLE:</p> <p>Low set stage (Stage-I): 110% - 112% (typically 110%) with a time delay of 5 seconds.</p> <p>High set stage (Stage-II): 140% - 150% with a time delay of 100 milliseconds.</p> <p>Drop-off to pick-up ratio of overvoltage relay: better than 97%</p> <p>Grading: Voltage as well as time grading may be</p>

S.N.	Protection Setting/Protocol	Mandated Setting for transmission lines
		done for multi circuit lines/cable.
18	<b>Resistive reach setting to prevent load point encroachment</b>	<p>Following criteria may be considered for deciding load point encroachment:</p> <ul style="list-style-type: none"> <li>• Maximum load current (Imax) may be considered as 1.5 times the thermal rating of the line or 1.5 times the associated bay equipment current rating (the minimum of the bay equipment individual rating) whichever is lower. (Caution: The rating considered is approximately 15minutes rating of the transmission facility).</li> <li>• Minimum voltage (V min) to be considered as 0.85pu (85%).</li> </ul>
19	<b>Direct Inter-trip</b>	<p>To be sent on operation of following:</p> <ol style="list-style-type: none"> <li>i. Overvoltage Protection</li> <li>ii. LBB Protection</li> <li>iii. Busbar Protection</li> <li>iv. Reactor Protection</li> <li>v. Manual Trip (400KV and above)</li> <li>vi. Cable Fault (in composite lines)</li> </ol>
20	<b>Permissive Inter-trip</b>	To be sent on operation of Distance Protection

## Annexure – 7: Work Order & Corrigendum



पावर ट्रांसमिशन कारपोरेशन ऑफ उत्तराखण्ड लि०  
(उत्तराखण्ड सरकार का उपक्रम)  
अधीक्षण अभियन्ता (परीक्षण एवं परिचालन एवं स्काडा) कार्यालय  
कुमायु मण्डल हल्द्वानी  
मोबाइल नं० 9412089275, ईमेल dp\_singh@ptcul.org

No. 376 /SE (T&C)/PTCUL/ (H)/

Date:29.09.2023

Subject:- Order for Protection Audit of 02 Nos 400 kV and 08 Nos 220KV sub-stations in PTCUL.

Joint Advisor

Central Board of Irrigation and Power

Malcha Marg Chanakyapuri,

New Delhi-110021

Email: mrchauhan@cbip.org.

Dear Sir,

In reference to your offer submitted vide Ref No: P-1/CBIP/PTCUL/PTCUL/Audit/2023 dated: 11.09.2023 through email against Email enquiry dated 05.09.2023, an order is hereby placed in favour of your firm for the work of "Protection Audit of 02 Nos 400kV and 08 Nos 220 kV substations of PTCUL". The detail of material, price schedule and terms & conditions is here as under:-

Sr.No	Description	Unit	Qty	Amount	Total Amount
1	Protection Audit to be carried out for the following 10 nos of the 400/220kV substations of PTCUL :- 1. 400kV S/s Rishikesh 2. 400 kV S/s Kashipur 3. 220kV S/s Chamba 4. 220kV S/s Rishikesh 5. 220kV S/s Roorkee 6. 220kV S/s Haridwar (SIDCUL) 7. 220kV S/s Jhajra. 8. 220 kV S/s Pantnagar. 9. 220 kV S/s Haldwani. 10. 220kV S/s Mahuakheraganj.	Job	1	36,25,000	36,25,000
	TOTAL				36,25,000

Total value of order is Rs.36,25,000 (Rupees Thirty Six Lakh Twenty Five Thousand only ) Plus GST Extra.

End: 1. Terms & Conditions.

Please acknowledge the receipt and acceptance of order.

(D.P Singh)

Superintending Engineer (T&C), Haldwani

No.376 /SE (T&C)/PTCUL/ (H)/

Date:29.09.2023

Copy forwarded to the following for information and necessary action:-

1. Director (Operation), PTCUL, Dehradun.
2. Superintending Engineer (A) MD, PTCUL, Dehradun.
3. Chief Engineer, T&C PTCUL, 132kV Substation Campus, Kathgodam Nainital.
4. Executive Engineer, T&C Division, Kashipur.
5. Director (Energy), Central Board of Irrigation and Power Malcha Marg Chanakyapuri, New Delhi-110021 Email: [sanjeev@cbip.org](mailto:sanjeev@cbip.org)

(D.P Singh)

Superintending Engineer (T&C), Haldwani

मुख्यालय एवंपंजीकृत कार्यालय:-विद्युतमवन, नजदीक-आई०एस०बी०टी० क्रॉसिंग, सहारनपुररोड, माजरा, देहरादून-248002  
कारपोरेटआईडी नं०: U40101UR2004GOI028675 दूरभाष नं० 0135-2646000 फैक्स नं० 0135-2643460 वेबसाइट [www.ptcul.org](http://www.ptcul.org)





पावर ट्रॉसमिशन कारपोरेशन ऑफ उत्तराखण्ड लि०  
(उत्तराखण्ड सरकार का उपक्रम)  
अधीक्षण अभियन्ता (परीक्षण एवं परिचालन एवं स्काडा) कार्यालय  
कुमायु मण्डल हल्द्वानी  
मोबाइल नं० 9412089275, ईमेल dp\_singh@ptcul.org

Terms & Conditions:-

1	Scope	<p>: The detailed Scope work is as under:</p> <ol style="list-style-type: none"><li>1. There must be a kick off meeting for discussion on project plan before start of the work in field and the detailed plan of performance shall be submitted by CBIP.</li><li>2. Requisite data shall be collected in standard format from PTCUL grid substations by authorized and experienced auditor.</li><li>3. The site surveys and audit of grid substations of PTCUL shall be done by authorized and experienced auditor.</li><li>4. Review of the implemented protection schemes/philosophy for 400/220 kV substations which includes protection of transmission lines,interconnecting transformers, line/busreactors, bus bar, bus couplers etc.as per latest guidelines of Ramakrishna committee/CBIP/NRPC/Intenational best practices,etc.</li><li>5. Review the adequacy of primary and backup protection settings for protected equipment and suggest corrective measures where evernon compliance with respect to Ramakrishna committee/ CBIP/NRPC is found during the protection audit.</li><li>6. Review of availability/healthiness of PLCC communication links used for protection systems.</li><li>7. Review the healthiness/adequacy of 220/110/50V DC system available at substations for protection application.</li><li>8. Review of availability/healthiness of GPS system and time synchronization facility used for protection.</li><li>9. Review of availability/healthiness of recording instruments like DRs /ELs for transmission lines protection.</li><li>10. Review of test reports for assessing the healthiness of circuit breakers, CT &amp; CVT based upon available test reports at sites.</li><li>11. Field inspection of protection device for obsolescence of technology, suitability and healthiness.</li><li>12. Directory of the protection system &amp; recommendation for replacement of obsolescence relays with compatible numerical relays will be provided.</li><li>13. Checking of availability of DGset/auxiliary DC supply at substations.</li><li>14. Site visits for onsite protection audit, review and inspection of substations will be performed.</li><li>15. Submission of the detailed report for the protection audit including the protection philosophy, reviewed settings and protection audit observations.</li><li>16. The performance of above protection equipment like relays, circuit breaker, CT, CVT, DC battery bank, synchro facility, communication facility used for protection will be also checked through physical inspection and provided test reports/documents. These protection equipments will be recommended for renovation and upgradation based on their performance accessed during protection audit and physical inspection.</li><li>17. Review the availability healthiness of<ul style="list-style-type: none"><li>• Event recorders/ loggers' operation history</li><li>• CT, CVT, CB</li><li>• DC power supply</li><li>• Auxiliary supply</li><li>• Communication links</li><li>• Time synchronization/ GPS</li></ul></li><li>18. Review of Testing and Maintenance records of all protective relays, Circuit Breakers CT, CVT etc. Review of protection philosophy.</li></ol>
---	-------	--

मुख्यालय एवंपजीकृत कार्यालय:-विद्युतमवन, नजदीक-आई०एस०बी०टी० क्रासिंग, सहारनपुररोड, माजरा, देहरादून-248002  
कारपोरेटआईडी नं०: U40101UR2004GOI028675 दूरभाष नं० 0135-2646000 फ़ैक्स नं० 0135-2643460 वेबसाइटwww.ptcul.org



पावर ट्रांसमिशन कारपोरेशन ऑफ उत्तराखण्ड लि०  
(उत्तराखण्ड सरकार का उपक्रम)  
अधीक्षण अभियन्ता (परीक्षण एवं परिचालन एवं स्काडा) कार्यालय  
कुमायु मण्डल हल्द्वानी  
मोबाइल नं० 9412089275, ईमेल dp\_singh@ptcul.org

			19. Anything which is left to be mentioned here but required for successful completion of the aforementioned subject work shall be done <b>Central Board of Irrigation and Power Malcha Marg Chanakyapuri, New Delhi-110021</b> 20. CBIP Delhi shall submit a report on detailed points in four sets of hard copy duly spiraled binding as well as soft copy shall be submitted. 21. The safety guidelines prevalent in PTCUL must be followed.
2	GST	:	GST shall be paid extra as per applicable Government rules.
3	Tax	:	Tax shall be deducted at source as per applicable Government rules. A certificate to this effect may be given to the Contractor if required.
4	Date of Start of work	:	Order shall be considered as having come in to force from the date of issue of order.
5	Supply Completion	:	NA
6	Work completion	:	The work should be completed within 24 months from the date of issue of order.
7	Engineer of the contract	:	Superintending Engineer (T&C), Haldwani is the "Engineer of the contract" who shall be placing the order for the work with the contractor and signing the contract agreement and who has been inherently vested with such powers by corporation in this behalf and shall act as Engineer for the purpose of the contract.
8	Engineer in-charge	:	Respective Executive Engineer (T&C) shall be "Engineer in charge" for the subject work.
9	Liquidity damages	:	If the contract is delayed beyond the stipulated period mentioned in the contract. The liquidity damages shall be levied @ 0.5 % per week and maximum up to 10% of contract value.
10	Dispute	:	All Dispute arising out of this case under the jurisdiction local court at Kashipur and Honable High Court, Nainital.
11	Payment terms	:	1. 25% Payment will be made within 30 days after finalization of Audit plan, subject to availability of funds from PTCUL HQ. 2. 35% Payment will be made within 30 days after submission of preliminary reports verified by Executive Engineer of respective division, subject to availability of funds from PTCUL HQ. 3. 40 % Payment will be made within 30 days after submission of final reports verified by Executive Engineer of respective division, subject to availability of funds from PTCUL HQ.
12	Payment unit	:	Test & Commissioning Division, Kashipur shall be the payment unit and all units where is to be work done shall record the measurement and duly passed bills along with measurement book shall be submitted to payment unit.
13	Warranty period	:	NA.
14	Billing Address	:	Executive Engineer Test & Commissioning Division, PTCUL 400 KV Substation Campus, Kashipur (Uttarakhand)-244713, GSTIN No. (05AAECM1785FC29)

All other term and condition of this order shall be governed by the General conditions of the contract prevalent in PTCUL.

  
(D.P. Singh)

Superintending Engineer(T&C), Haldwani

मुख्यालय एवंपंजीकृत कार्यालय:-विद्युतमवन, नजदीक-आई०एस०बी०टी० क्रासिंग, सहारनपुररोड, गाजरा, देहरादून-248002  
कारपोरेटआईडी नं०: U40101UR2004GOI028675 दूरभाष नं० 0135-2646000 फैक्स नं० 0135-2643460 वेबसाइट [www.ptcul.org](http://www.ptcul.org)



पावर ट्रॉसमिशन कारपोरेशन ऑफ उत्तराखण्ड लि०  
(उत्तराखण्ड सरकार का उपक्रम)  
अधीक्षण अभियन्ता (परीक्षण एवं परिचालन एवं स्काडा) कार्यालय  
कुमायु मण्डल हल्द्वानी  
मोबाइल नं० 9412089275, ईमेल dp\_singh@ptcul.org

No. 394 /SE (T&C)/PTCUL/ (H)/

Date:26.10.2023

Subject:- Corrigendum for the Order for the work of Protection Audit of 02 Nos 400 kV and 08 Nos 220KV sub-stations in PTCUL

Joint Advisor

Central Board of Irrigation and Power

Malcha Marg Chanakyapuri,

New Delhi-110021

Email: mrchauhan@cbip.org.

Dear Sir,

In reference to above mentioned subject, please refer to kick off meeting held on dated 26.10.2023 for the work of Protection Audit of 02 Nos 400 kV and 08 Nos 220KV sub-stations in PTCUL against order no.376 dated 29.09.2023.

In this regard, kindly find enclosed herewith corrigendum of order no.376 dated 29.09.2023 (Annexure-1) with necessary amendments as discussed in afforementioned meeting.

This is for your kind information and necessary action.

Please acknowledge the receipt and acceptance of order.

(D.P Singh)

Superintending Engineer (T&C), Haldwani

Copy forwarded to the following for information and necessary action:-

1. Chief Engineer, T&C PTCUL, 132kV Substation Campus, Kathgodam Nainital..
2. Executive Engineer, T&C Division, Roorkee/Dehradun/Haldwani/Kashipur/Rishikesh with request to provide assistance and information to CBIP for the above work.
3. Director (Energy), Central Board of Irrigation and Power Malcha Marg Chanakyapuri, New Delhi-110021  
Email: [sanjeev@cbip.org](mailto:sanjeev@cbip.org)





मुख्यालय एवंपञ्जीकृत कार्यालय:-विद्युतमवन, नजदीक-आई०एस०बी०टी० क्रॉसिंग, सहारनपुररोड, माजरा, देहरादून-248002  
कारपोरेटआईडी नं०: U40101UR2004GOI028675 दूरभाष नं० 0135-2646000 फॅक्स नं० 0135-2643460 वेबसाइट [www.ptcul.org](http://www.ptcul.org)



Annexure -1 – Work order corrigendum

Scope: The detailed Scope work is as under:

S. No.	Clause of PO	Existing Clause					Modified Clause						
		Sr. No	Description	Unit	Qty	Amount	Total Amount	Sr. No	Description	Unit	Qty	Unit rate (Rs.)	Total Amount (Rs.)
1	Price Schedule	1	Protection Audit to be carried out for the following 10 nos. of the 400/220kV substations of PTCUL:- 1. 400kV S/s Rishikesh 2. 400 KV S/s Kashipur 3. 220kV S/s Chamba 4. 220kV S/s Rishikesh 5. 220kV S/s Roorkee 6. 220kV S/s Haridwar (SIDCUL) 7. 220kV S/s Jhajra 8. 220 KV S/s Pantnagar. 9. 220 KV S/s Haldwani. 10. 220kV S/s Mahuaikheraganj.	Job	1	36,25,000	36,25,000	1	Protection Audit to be carried out for the following 10 nos of the 400/220kV substations of PTCUL:- 1. 400kV S/s Rishikesh 2. 400 KV S/s Kashipur 3. 220kV S/s Chamba 4. 220kV S/s Rishikesh 5. 220kV S/s Roorkee 6. 220kV S/s Haridwar (SIDCUL) 7. 220kV S/s Jhajra 8. 220 KV S/s Pantnagar 9. 220 KV S/s Haldwani 10. 220kV S/s Mahuaikheraganj)	Each	10	3,62,500	36,25,000
		TOTAL					36,25,000	TOTAL					36,25,000
2	Terms and Conditions S. No. 1 – Scope	1.	There must be a kick off meeting for discussion on project plan before start of the work in field and the detailed plan of performance shall be submitted by CBIP.					1. There must be a kick off meeting for discussion on project plan before start of the work in field and the detailed plan of performance shall be submitted by CBIP.					
		2.	Requisite data shall be collected in standard format from PTCUL grid substations by authorized and experienced auditor.					2. Requisite data shall be collected in standard format from PTCUL grid substations by an experienced auditor.					
		3.	The site surveys and audit of grid substations of PTCUL shall be done by authorized and experienced auditor.					3. The site surveys and audit of grid substations of PTCUL shall be done by an experienced auditor.					
		4.	Review of the implemented protection schemes/ philosophy for 400/220 kV substations which includes protection of transmission lines, interconnecting transformers, line/bus reactors, bus bar, bus					4. Review of the implemented protection schemes/philosophy for 400/220 kV substations which includes protection of transmission lines, interconnecting transformers, line/bus reactors, bus bar, bus couplers etc with respect to					

5. Clause of PO	Existing Clause	Modified Clause
	<p>couplers etc.as per latest guidelines of Ramakrishna committee/ CBP/NRPC/international best practices. etc.</p> <p>5. Review the adequacy of primary and backup protection settings for protected equipment and suggest corrective measures where everyone compliance with respect to Ramakrishna committee/ CBP/NRPC is found during the protection audit.</p> <p>6. Review of availability/healthiness of PLCC communication links used for protection systems.</p> <p>7. Review the healthiness/adequacy of 220/110/50V DC system available at substations for protection application.</p> <p>8. Review of availability/healthiness of GPS system and time synchronization facility used for protection.</p> <p>9. Review of availability/healthiness of recording instruments like DIRs /ELs for transmission lines protection.</p> <p>10. Review of test reports for assessing the healthiness of circuit breakers, CT &amp; CVT based upon available test reports at sites.</p> <p>11. Field inspection of protection device for obsolescence of technology, suitability and healthiness.</p> <p>12. Directory of the protection system &amp; recommendation for replacement of obsolescence relays with compatible numerical relays will be provided.</p> <p>13. Checking of availability of DG Set/auxiliary DC supply at substations.</p> <p>14. Site visits for onsite protection audit, review and inspection of substations will be performed.</p> <p>15. Submission of the detailed report for the protection audit including the protection philosophy, reviewed settings and protection audit observations.</p> <p>16. The performance of above protection equipment like relays, circuit breaker, CT, CVT, DC battery bank, synchro facility, communication facility used for protection will be also checked through physical inspection and provided test reports/documents. These protection equipment's will be recommended for renovation and upgradation based on their performance accessed during protection audit and physical inspection.</p>	<p>tripping in last one year as per latest guidelines of Ramakrishna committee/ CBP/NRPC/international best practices, which includes review of the following:</p> <p>a) Adequacy of primary and backup protection settings for protected equipment and suggest corrective measures</p> <p>b) Availability/healthiness of PLCC communication links used for protection systems.</p> <p>c) Healthiness/adequacy of 220/110/50V DC system available at substations for protection application.</p> <p>d) Availability/healthiness of GPS system and time synchronization facility used for protection.</p> <p>e) Availability/healthiness of recording instruments like DIRs /ELs for transmission lines protection.</p> <p>f) Test reports for assessing the healthiness of circuit breakers, CT &amp; CVT based upon available test reports at sites.</p> <p>g) Field inspection of protection device for obsolescence of technology, suitability and healthiness.</p> <p>h) Prepare recommendation for replacement of obsolescence relays with compatible numerical relays will be provided.</p> <p>i) Checking of availability of DG Set / auxiliary DC supply at substations.</p> <p>5. Site visits for onsite protection audit, review and inspection of substations will be performed</p> <p>6. Submission of the detailed report for the protection audit including the protection philosophy, reviewed settings and protection audit observations.</p>
		Deleted as it is covered in point 4 above.





S. No.	Clause of PO	Existing Clause	Modified Clause
		<p>17. Review the availability healthiness of</p> <ul style="list-style-type: none"> <li>• Event recorders/ loggers' operation history</li> <li>• CT, CVT, CB</li> <li>• DC power supply</li> <li>• Auxiliary supply</li> <li>• Communication links</li> <li>• Time-synchronization/ GPS</li> </ul> <p>18. Review of Testing and Maintenance records of all protective relays, Circuit Breakers, CT, CVT etc. Review of protection philosophy.</p> <p>19. Anything which is left to be mentioned here but required for successful completion of the aforementioned subject work shall be done Central Board of Irrigation and Power Malcha Marg Chanakyapuri, New Delhi-110021</p> <p>20. CBIP Delhi shall submit a report on detailed points in four sets of hard copy duly spiraled binding as well as soft copy shall be submitted.</p> <p>21. The safety guidelines prevalent in PTCUL must be followed.</p>	<p>7. Anything which is left to be mentioned here but required for successful completion of the aforementioned subject work shall be done by Central Board of Irrigation and Power.</p> <p>8. CBIP Delhi shall submit a protection report on detailed points in four sets of hard copy duly spiraled binding and in soft copy as well.</p> <p>9. The safety guidelines prevalent in PTCUL must be followed.</p>
3	Terms and Conditions - S. No. 6 - Work Completion	The work should be completed within 24 months from the date of issue of order	The work should be completed within 24 weeks from the date of issue of corrigendum.
4	Terms and Conditions - S. No. 8 - Engineer-in-charge	Respective Executive Engineer (T&C) shall be "Engineer in charge" for the subject work.	<p>The following Executive Engineers (T&amp;C) shall be "Engineer in charge" for the subject work:</p> <p>a) 400KV Rishikesh, 220KV Rishikesh, 220 kV Chamba – Mr. Harsh Verma (Ph. No.9412074038 &amp; Email: ee_tandc_rsh@ptcul.org).</p> <p>b) 400KV Kashipur, 220KV Pantnagar, 220KV Haldwani &amp; 220KV MahuaKheraganj – Mr. Asim Baig (Ph. No. 9412087885 &amp; Email: ee_tandc_ksp@ptcul.org).</p> <p>c) 220KV SIDCUL Haridwar, 220 KV Roorkee – Mr. Ashwini Kumar (Ph. No.7088117301 &amp; Email: ee_tandc_he@ptcul.org).</p> <p>d) 220KV Jhajra – Mr. Ravindra Kumar (Ph. No. 9927744222 &amp; Email: ee_tandc_ddun@ptcul.org).</p>







S. No.	Clause of PO	Existing Clause	Modified Clause
5	<p>Terms and Conditions</p> <p>5. No. 11 - Payment Terms</p>	<ol style="list-style-type: none"> <li>1. 25% Payment will be made within 30 days after finalization of Audit plan, subject to availability of funds from PTCUL HQ.</li> <li>2. 35% Payment will be made within 30 days after submission of preliminary reports verified by Executive Engineer of respective division, subject to availability of funds from PTCUL HQ.</li> <li>3. 40 % Payment will be made within 30 days after submission of final reports verified by Executive Engineer of respective division, subject to availability of funds from PTCUL HQ.</li> </ol>	<ol style="list-style-type: none"> <li>1. 25% Payment will be made within 30 days after finalization of Audit plan, subject to availability of funds from PTCUL HQ.</li> <li>2. 35% Payment will be made within 30 days after submission of preliminary reports <b>on prorata basis</b> verified by Executive Engineer of respective division, subject to availability of funds from PTCUL HQ.</li> <li>3. 40 % Payment will be made within 30 days after submission of final reports <b>on prorata basis</b> verified by Executive Engineer of respective division, subject to availability of funds from PTCUL HQ.</li> <li>4. The local travel, lodging &amp; boarding shall be arranged by PTCUL on free-of-cost basis for CBIP team visiting the substation</li> </ol>







## **Annexure – 8: Data Sheets**



## Contents

<b>Single Line Diagrams</b> .....	60
<i>Substation Single Line Diagram</i> .....	60
<i>AC Auxiliary System</i> .....	61
<i>DC Auxiliary System</i> .....	62
<i>SAS Architecture diagrams</i> .....	63
<b>Transmission Lines</b> .....	65
<b>Bus-Bar Protection</b> .....	74
<b>AC Auxiliary System</b> .....	77
<b>DC Auxiliary System</b> .....	78
<b>Circuit Breakers</b> .....	79
<b>Current Transformer</b> .....	81
<b>Disturbance Recorder (DR) &amp; Event Logger (EL)</b> .....	87
<b>Communication System</b> .....	88
<b>Network Diagram of Uttarakhand</b> .....	89
<b>Power Map of Uttarakhand</b> .....	90

# Protection Audit of 400/220/132kV Kashipur Substation

## Annexure - 8

### Data Sheets

## Single Line Diagrams

### *Substation Single Line Diagram*

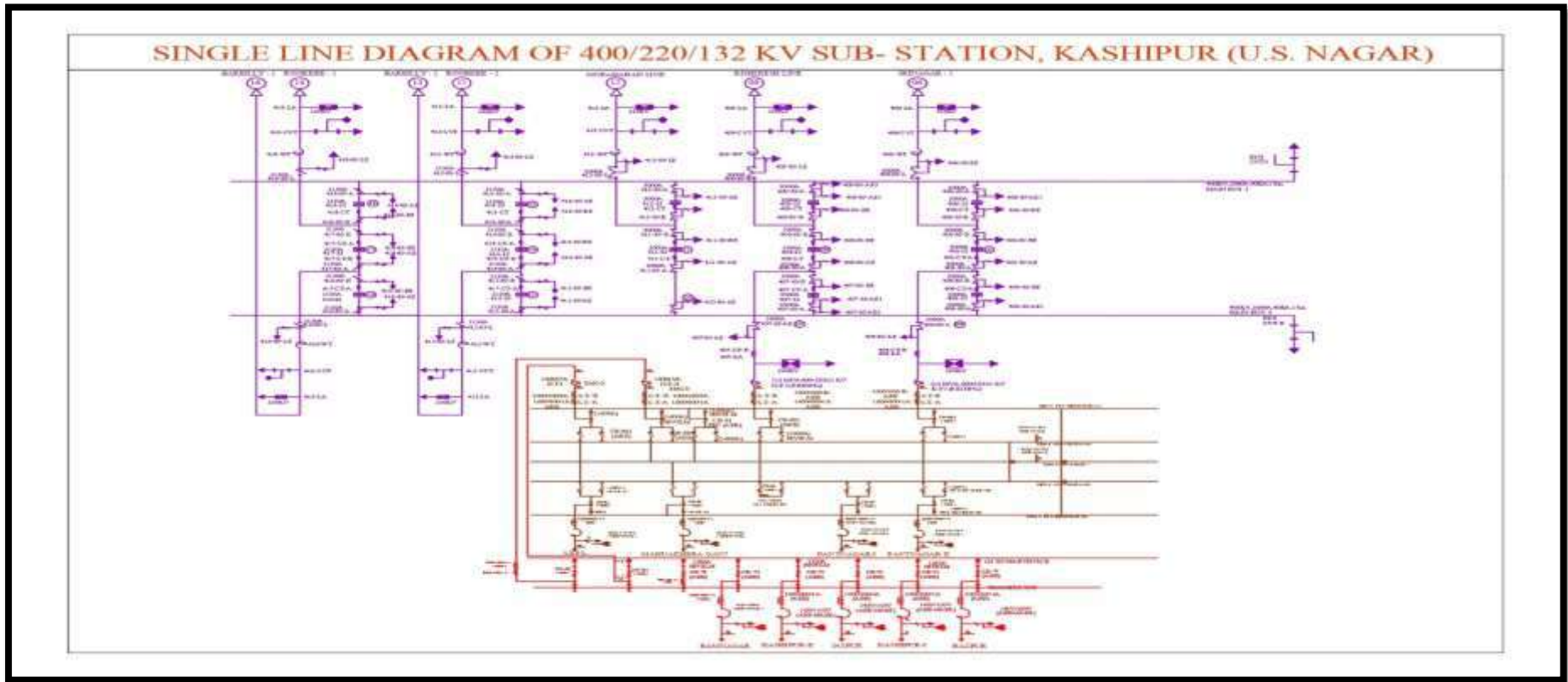

AC Auxiliary System

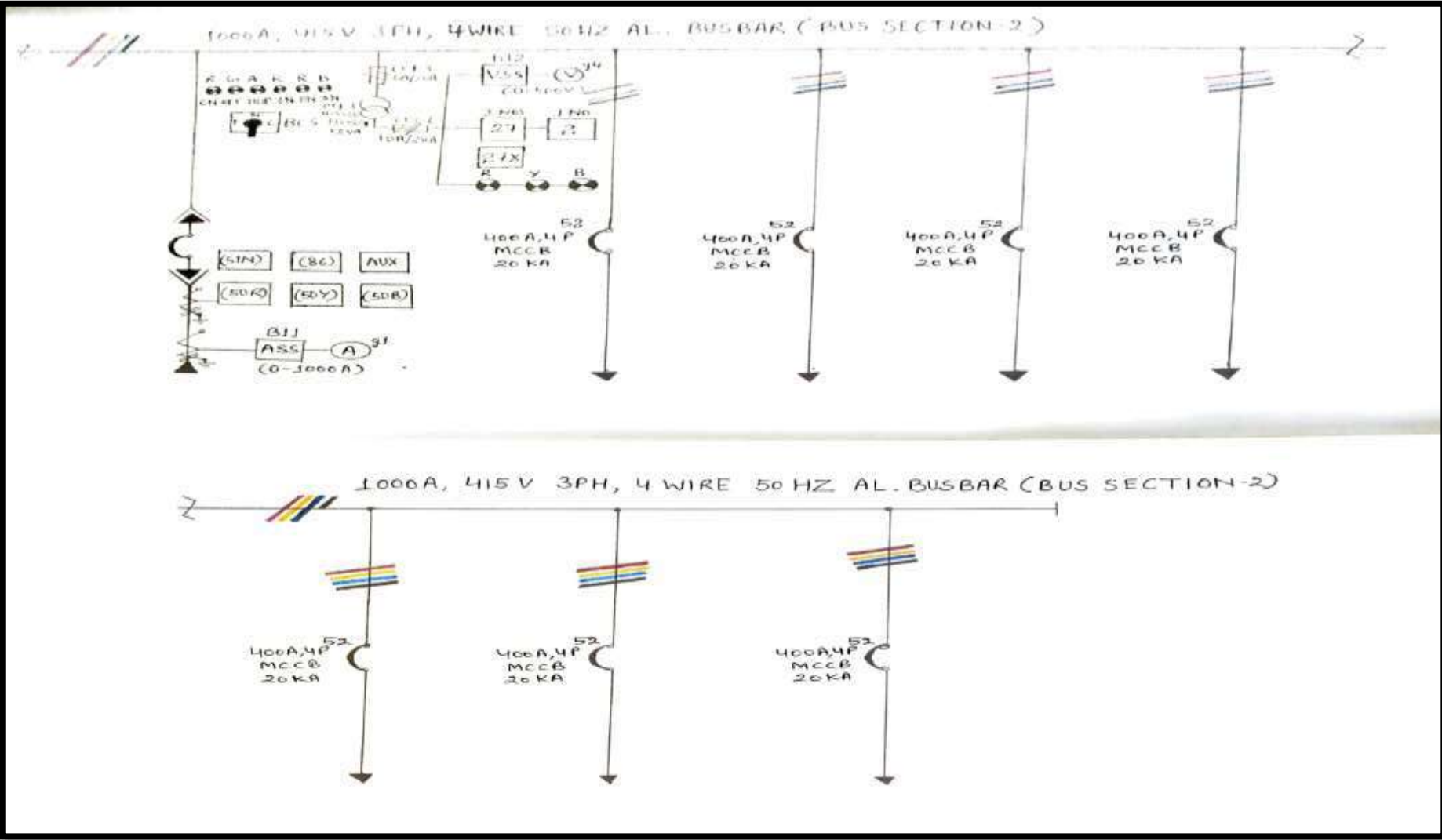

*DC Auxiliary System*

**Not Available**

SAS Architecture diagrams



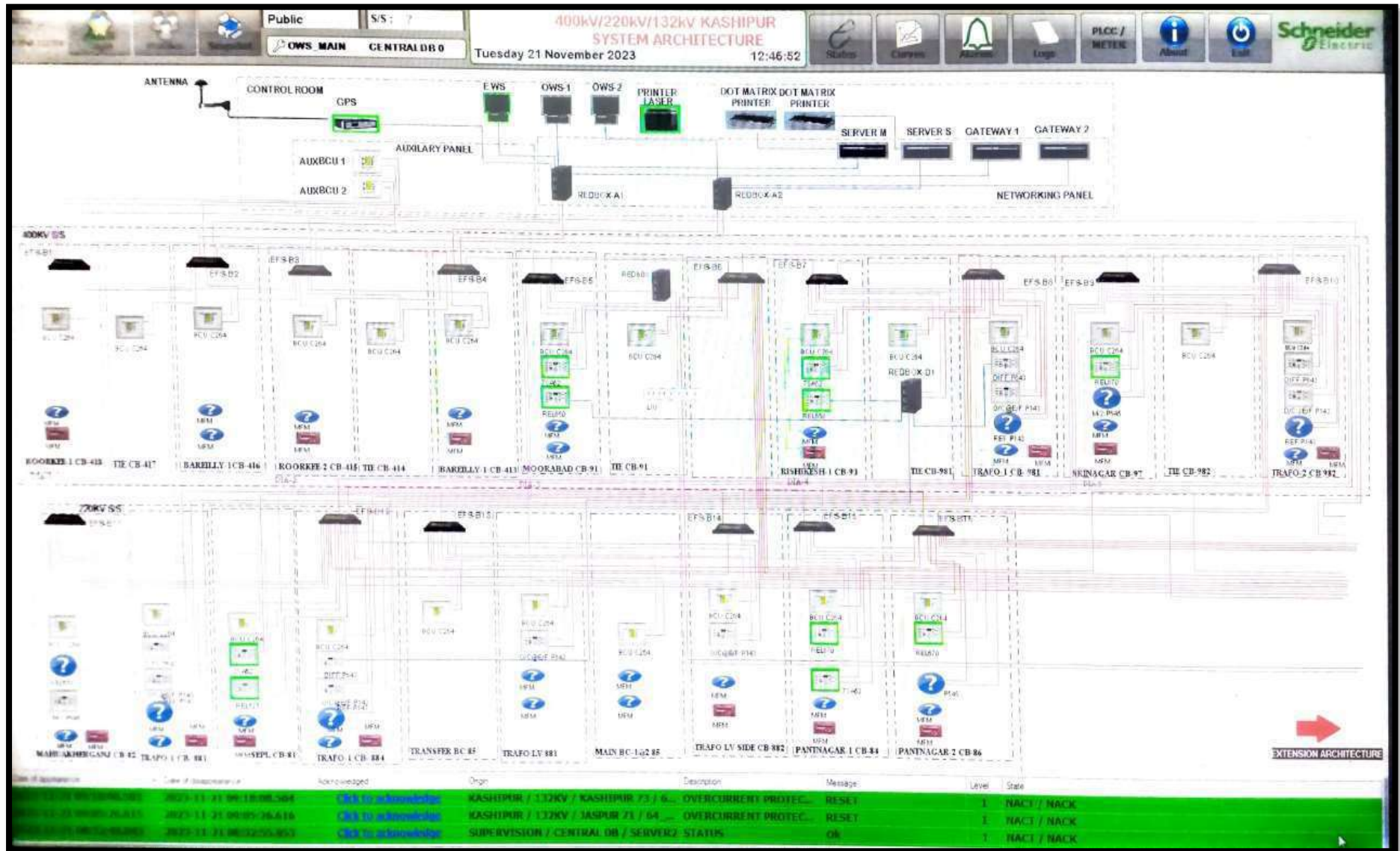



## Transmission Lines

400kV:

	Line-1	Line-2	Line-3
<b>Name of Line</b>	400KV Kashipur-Nehtaur Line	400KV Kashipur-Moradabad Line	400KV Kashipur-Srinagar Line
<b>Line length (km)</b>	110Km	107Km	Feeder not commissioned

Particulars	Tr Line 1	Tr Line 2	Tr Line 3
<b>Series Compensated (Yes/No)</b>	NOT	NOT	NOT
<b>Connected to dedicated CT core (mention name) LINE</b>	CORE-1 for busbar Protection, CORE-2 for busbar protection, CORE-3 for metering, CORE-4 for main-2, CORE-5 for main-1.	CORE-1 for busbar Protection, CORE-2 for busbar protection, CORE-3 for metering, CORE-4 for main-2, CORE-5 for main-1.	CORE-1 for busbar Protection, CORE-2 for busbar protection, CORE-3 for metering, CORE-4 for main-2, CORE-5 for main-1.
<b>Connected to dedicated CT core (mention name) TIE</b>	CORE-1 Differential for X-former 1, CORE-2 O/C for X-former -1, CORE-3 for metering, CORE-4 for main-2, CORE-5 for main-1.	CORE-1 spare, CORE-2 spare, CORE-3 for metering, CORE-4 for main-2, CORE-5 for main-1.	CORE-1 Differential for X-former 2, CORE-2 O/C for X-former -2, CORE-3 for metering, CORE-4 for main-2, CORE-5 for main-1.
<b>CT Ratio</b>	2000:1	2000:1	-
<b>Connected to dedicated PT core (mention name)</b>	CORE-1 for main-2, CORE-2 for main-1, CORE-3 for metering.	CORE-1 for main-2, CORE-2 for main-1, CORE-3 for metering.	CORE-1 for main-2, CORE-2 for main-1, CORE-3 for metering.

Particulars		Tr Line 1	Tr Line 2	Tr Line 3
<b>PT Ratio</b>		400KV:110V	4000KV:110V	400KV:110V
<b>Relay connected to Trip Coil-1 or 2 or both</b>		BOTH	BOTH	BOTH
<b>Feed from DC supply-1 or 2</b>		BOTH	BOTH	BOTH
<b>i</b>	Main-I Protection (Make and Model)	Siemens 7SA52	ABB REL650	ABB REL670
	Functional (Yes/No)	YES	YES	YES
<b>ii</b>	Main-II Protection (Make and Model)	ABB REL650	Siemens 7SA52	NA
	Functional (Yes/No)	YES	YES	YES
<b>iii</b>	LBB Protection (Make and Model)	ABB(RAICA)	ABB(RAICA)	ABB(RAICA)
	Functional (Yes/No)	YES	YES	NA
	Date of testing	NA	NA	NA
<b>iv</b>	PLCC/ Protection coupler (Make and Model)	NA	NA	NA
	Functional (Yes/No)	NA	NA	NA
<b>v</b>	DR (Make & Model) (Make and Model)	NA	NA	NA
	Functional (Yes/No)	NA	NA	NA
<b>vi</b>	Time Synch. Unit (Make and Model)	SANDS	SANDS	SANDS



<b>Particulars</b>		<b>Tr Line 1</b>	<b>Tr Line 2</b>	<b>Tr Line 3</b>
	Functional (Yes/No)	YES	YES	YES
<b>1</b>	Status of Power Swing	ENABLE	ENABLE	ENABLE
<b>2</b>	Out of Step	1	1	1
<b>3</b>	SOTF	ENABLE	ENABLE	ENABLE
<b>4</b>	Breaker Failure	ENABLE	ENABLE	ENABLE
<b>5</b>	Broken Conductor	ENABLE	ENABLE	ENABLE
<b>6</b>	STUB	ENABLE	ENABLE	ENABLE
<b>7</b>	Fault Locator	ENABLE	ENABLE	ENABLE
<b>8</b>	Disturbance Recorder	VISIBLE	VISIBLE	VISIBLE
<b>9</b>	VT fuse fail	ENABLE	ENABLE	ENABLE
<b>10</b>	Overvoltage Protection	ENABLE	ENABLE	ENABLE
<b>11</b>	Trip Circuit supervision	Healthy	Healthy	Healthy
<b>12</b>	Auto-reclose	ENABLE	ENABLE	ENABLE
<b>13</b>	Load encroachment	NA	NA	NA

**220 KV:**

Particulars	Line-1	Line-2	Line-3	Line-4
Name of Line	220KV Kashipur-Pantnagar Line	220KV JAFARPUR LINE	220KV SEPL LINE	220KV Mahuakheraganj line
Line length (km)	61.5 Km	52.9 Km	19.05 Km	16.79km

Particulars	Tr Line 1	Tr Line 2	Tr Line 3	Tr Line 4
Series Compensated (Yes/No)	NOT	NOT	NOT	NOT
Connected to dedicated CT core (mention name)	CORE-1 for busbar Protection, CORE-2 for busbar protection, CORE-3 for metering, CORE-4 for main-2, CORE-5 for main-1.	CORE-1 for busbar Protection, CORE-2 for busbar protection, CORE-3 for metering, CORE-4 for main-2, CORE-5 for main-1.	CORE-1 for busbar Protection, CORE-2 for busbar protection, CORE-3 for metering, CORE-4 for main-2, CORE-5 for main-1.	CORE-1 for busbar Protection, CORE-2 for busbar protection, CORE-3 for metering, CORE-4 for main-2, CORE-5 for main-1.
CT Ratio	800:1	800:1	800:1	800:1
Connected to dedicated PT core (mention name)	CORE-1 for main-2, CORE-2 for main-1, CORE-3 for metering.	CORE-1 for main-2, CORE-2 for main-1, CORE-3 for metering.	CORE-1 for main-2, CORE-2 for main-1, CORE-3 for metering.	CORE-1 for main-2, CORE-2 for main-1, CORE-3 for metering.
PT Ratio	220KV:110V	220KV:110V	220KV:110V	220KV:110V
Relay connected to Trip Coil-1 or 2 or both	BOTH	BOTH	BOTH	BOTH
Feed from DC supply-1 or 2	BOTH	BOTH	BOTH	BOTH

Particulars		Tr Line 1	Tr Line 2	Tr Line 3	Tr Line 4
<b>i</b>	Main-I Protection (Make and Model)	ABB REL670	ABB REL670	ABB REL621	Micom P442
	Functional (Yes/No)	YES	YES	YES	YES
	Date of testing				
<b>ii</b>	Main-II Protection Relay (Make and Model)	Siemens 7SA52	Siemens 7SA52	Siemens 7SA52	Micom P545
	Functional (Yes/No)	YES	YES	YES	YES
<b>iii</b>	LBB Protection (Make and Model)	ABB(RAICA)	ABB(RAICA)	ABB(RAICA)	ABB(RAICA)
	Functional (Yes/No)	YES	YES	YES	YES
<b>iv</b>	PLCC/ Protection coupler (Make and Model)	NA	NA	NA	NA
	Functional (Yes/No)	No	No	No	No
<b>v</b>	DR (Make & Model) (Make and Model)	NA	NA	NA	NA
	Functional (Yes/No)	No	No	No	No
<b>vi</b>	Time Synch.Unit (Make and Model)	SANDS	SANDS	SANDS	SANDS
	Functional (Yes/No)	YES	YES	YES	YES
<b>1</b>	Status of Power Swing	ENABLE	ENABLE	ENABLE	ENABLE

Particulars		Tr Line 1	Tr Line 2	Tr Line 3	Tr Line 4
2	Out of Step	1	1	1	1
3	SOTF	ENABLE	ENABLE	ENABLE	ENABLE
4	Breaker Failure	ENABLE	ENABLE	ENABLE	ENABLE
5	Broken Conductor	ENABLE	ENABLE	ENABLE	ENABLE
6	STUB	ENABLE	ENABLE	ENABLE	ENABLE
7	Fault Locator	ENABLE	ENABLE	ENABLE	ENABLE
8	Disturbance Recorder	VISIBLE	VISIBLE	VISIBLE	VISIBLE
9	VT fuse fail	ENABLE	ENABLE	ENABLE	ENABLE
10	Overvoltage Protection	ENABLE	ENABLE	ENABLE	ENABLE
11	Trip supervision Circuit	HEALTHY	HEALTHY	HEALTHY	HEALTHY
12	Auto-reclose	ENABLE	ENABLE	ENABLE	ENABLE
13	Load encroachment	NA	NA	NA	NA

132kV:

Particulars	Line-1	Line-2	Line-3	Line-4	Line-5
Name of Line	132KV Kashipur ckt-1	132KV Kashipur ckt-2	132KV Bajpur ckt-1	Jaspur line	Ramnagar line
Line length (km)	5.5km	6.046km	15.216km	17.71km	23.5km

Particulars	Tr Line 1	Tr Line 2	Tr Line 3	Tr Line 4	Tr Line 5
Series Compensated (Yes/No)	NOT	NOT	NOT	NOT	NOT
Connected to dedicated CT core (mention name)	CORE-1 for busbar Protection, CORE-2 for busbar protection, CORE-3 for metering, CORE-4 for main-2, CORE-5 for main-1.	CORE-1 for busbar Protection, CORE-2 for busbar protection, CORE-3 for metering, CORE-4 for main-2, CORE-5 for main-1.	CORE-1 for busbar Protection, CORE-2 for busbar protection, CORE-3 for metering, CORE-4 for main-2, CORE-5 for main-1.	CORE-1 for busbar Protection, CORE-2 for busbar protection, CORE-3 for metering, CORE-4 for main-2, CORE-5 for main-1.	CORE-1 for busbar Protection, CORE-2 for busbar protection, CORE-3 for metering, CORE-4 for main-2, CORE-5 for main-1.
CT Ratio	1000:1	1000:1	1000:1	1000:1	1000:1
Connected to dedicated PT core (mention name)	CORE-1 for main-2, CORE-2 for main-1, CORE-3 for metering.	CORE-1 for main-2, CORE-2 for main-1, CORE-3 for metering.	CORE-1 for main-2, CORE-2 for main-1, CORE-3 for metering.	CORE-1 for main-2, CORE-2 for main-1, CORE-3 for metering.	CORE-1 for main-2, CORE-2 for main-1, CORE-3 for metering.

Particulars		Tr Line 1	Tr Line 2	Tr Line 3	Tr Line 4	Tr Line 5
<b>PT Ratio</b>		132KV:110V	132KV:110V	132KV:110V	132KV:110V	132KV:110V
<b>Relay connected to Trip Coil-1 or 2 or both</b>		BOTH	BOTH	BOTH	BOTH	BOTH
<b>Feed from DC supply-1 or 2</b>		BOTH	BOTH	BOTH	BOTH	BOTH
<b>i</b>	Main-I Protection (Make and Model)	Micom P545	Micom P545	Micom P545	Micom P545	Micom P545
	Functional (Yes/No)	YES	YES	YES	YES	YES
<b>ii</b>	O/C&E/F Protection Relay (Make and Model)	Micom P143	Micom P143	Micom P143	Micom P143	Micom P143
	Functional (Yes/No)	YES	YES	YES	YES	YES
<b>iii</b>	LBB Protection (Make and Model)	In built feature in relay.	In built feature in relay.	In built feature in relay.	In built feature in relay.	In built feature in relay.
	Functional (Yes/No)	YES	YES	YES	YES	YES
	Date of testing	NA	NA	NA	NA	NA
<b>iv</b>	PLCC/ Protection coupler (Make and Model)	NA	NA	NA	NA	NA
	Functional (Yes/No)	No	No	No	No	No
<b>v</b>	DR (Make & Model)	NA	NA	NA	NA	NA
	Functional (Yes/No)	No	No	No	No	No

Particulars		Tr Line 1	Tr Line 2	Tr Line 3	Tr Line 4	Tr Line 5
iv	Time Synch.Unit (Make and Model)	SANDS	SANDS	SANDS	SANDS	SANDS
	Functional (Yes/No)	YES	YES	YES	YES	YES
Other Protections						
1	Status of Power Swing	ENABLE	ENABLE	ENABLE	ENABLE	ENABLE
2	Out of Step	1	1	1	1	1
3	SOTF	ENABLE	ENABLE	ENABLE	ENABLE	ENABLE
4	Breaker Failure	ENABLE	ENABLE	ENABLE	ENABLE	ENABLE
5	Broken Conductor	ENABLE	ENABLE	ENABLE	ENABLE	ENABLE
6	STUB	ENABLE	ENABLE	ENABLE	ENABLE	ENABLE
7	Fault Locator	ENABLE	ENABLE	ENABLE	ENABLE	ENABLE
8	Disturbance Recorder	VISIBLE	VISIBLE	VISIBLE	VISIBLE	VISIBLE
9	VT fuse fail	ENABLE	ENABLE	ENABLE	ENABLE	ENABLE
10	Overvoltage Protection	ENABLE	ENABLE	ENABLE	ENABLE	ENABLE
11	Trip Circuit supervision	HEALTHY	HEALTHY	HEALTHY	HEALTHY	HEALTHY
12	Auto-reclose	ENABLE	ENABLE	ENABLE	ENABLE	ENABLE
13	Load encroachment	NA	NA	NA	NA	NA

## Bus-Bar Protection

### 400kV System:

Sl. No.	Particulars	Observations
a	Busbar and redundant relay make and model	Siemens7SS52
b	Type of Busbar arrangement	One and half Breaker
c	Zones	Three (Bus-1, Bus-2 and Check)
d	Dedicated CT core for each busbar protection	Yes (core -1 for main and core 2 for check)
e	Breaker Failure relay included, if additional then furnish make and model	In case of any BFR operating in sub-station, the relevant zone will be tripped.
f	Trip issued to both Busbar protection in case of enabling	Not applicable
g	Isolator indication and check relays	NA
h	Other requirements for protection checking and validation	The Bus-bar protection relay was replaced, but kept out of service as stability test is pending. Utility has informed that zone IV of all distance protection is set in reverse direction and 160 ms (less than zone 2 time), in the absence of bus-bar protection.



**220KV System:**

<b>Sl. No.</b>	<b>Particulars</b>	<b>Observations</b>
<b>a</b>	<b>Busbar and redundant relay make and model</b>	Siemens7SS52
<b>b</b>	<b>Type of Busbar arrangement</b>	2 main and transfer
<b>c</b>	<b>Zones</b>	Single zone
<b>d</b>	<b>Dedicated CT core for each busbar protection</b>	One CT core to be used
<b>e</b>	<b>Breaker Failure relay included, if additional then furnish make and model</b>	In case of any BFR operating in sub-station, the relevant zone will be tripped.
<b>f</b>	<b>Trip issued to both Busbar protection in case of enabling</b>	Not applicable
<b>g</b>	<b>Isolator indication and check relays</b>	This is part of Bay Unit
<b>h</b>	<b>Other requirements for protection checking and validation</b>	Panels erected. Under commissioning.

**132KV System:**

<b>Sl. No.</b>	<b>Particulars</b>	<b>Observations</b>
<b>a</b>	<b>Busbar and redundant relay make and model</b>	Siemens7SS52
<b>b</b>	<b>Type of Busbar arrangement</b>	1 main and transfer
<b>c</b>	<b>Zones</b>	Single
<b>d</b>	<b>Dedicated CT core for each busbar protection</b>	One CT core to be used
<b>e</b>	<b>Breaker Failure relay included, if additional then furnish make and model</b>	In case of any BFR operating in sub-station, the relevant zone will be tripped.
<b>f</b>	<b>Trip issued to both Busbar protection in case of enabling</b>	Not applicable
<b>g</b>	<b>Isolator indication and check relays</b>	This is part of Bay Unit
<b>h</b>	<b>Other requirements for protection checking and validation</b>	Panels erected. Under commissioning.

## AC Auxiliary System

Sl. No.	Particulars	Observations
a	Source of AC auxiliary system	1 no. 630kVA Station Transformers connected with 33kV transmission line from 132 kV Kashipur S/s (approx. 7km away) and 1 no. 630kVA Station Transformers connected with 33kV transmission line from 132 kV Ram Nagar S/s (approx. 20 km away)
b	Supply changeover between sources (Auto/Manual)	Load is distributed between two transformers. The emergency load is connected to separate distribution board. DG is connected to Emergency Board.
c	Diesel generator (DG) details	Make: Cummins Rating: 250 kVA
d	Maintenance plan and supply changeover periodicity in DG	a. The DG set operation is manual and some load is disconnected at the time of DG operation from Emergency board. b. Although, the auxiliary supply is reliable, DG operation is approx. 25 times a year.
e	Single Line Diagram	Attached
f	Other requirements for protection checking and validation	NA

## DC Auxiliary System

Sl. No.	Particulars	Observations			
		220 V DC - I	220 V DC - II	48 V DC-I	48 V DC-II
<b>a</b>	<b>Make</b>	Exide	HBL	HBL	HBL
<b>b</b>	<b>Model/Rating</b>	800Ah	800Ah	900Ah	900Ah
<b>c</b>	<b>Vintage</b>	2023	2006	2006	2006
<b>d</b>	<b>Measured voltage</b>				
<b>i</b>	<b>Positive to Earth</b>	0.297V	0.085V	NA	NA
<b>ii</b>	<b>Negative to Earth</b>	-237.9V	-237.9V	48	48
<b>E</b>	<b>No. of Cells Per Bank</b>	108	108	24	24
<b>F</b>	<b>Availability of Battery Charger</b>	Yes	Yes	Yes	Yes

## Circuit Breakers

Sl. No	Particulars	Make and Model	No. of trip/ close coil	Trip Coil Supervision relay and healthiness of coils	LBB Setting Stage 1	LBB Setting Stage 2	Remarks (If any)
<b>A</b>	<b>400kV System</b>						
<b>1</b>	400KV Nehtaur Moradabad, Srinagar Line,315MVA T/F I&II (Total 8 breakers)	MAKE-CGL	2/1	HEALTHY	ENABLE TIME DELAY-200 ms	DISABLE	NA
<b>2</b>	Roorkee Bareilly D/C Line dia (Total 6 breakers)	MAKE-Siemens	2/1	HEALTHY	ENABLE TIME DELAY-200 ms	DISABLE	Owned by PowerGrid Corp
<b>B</b>	<b>220kV System</b>						
<b>1</b>	220KV Pantnagar, Jafarpur, Mahuakheraganj, SEPL Line, 315 MVA T/F 1& 2,160MVA T/F I&II, TBC, BC (Total 10 breakers)	MAKE-CGL	2/1	HEALTHY	ENABLE TIME DELAY-200 ms	DISABLE	NA
<b>2</b>	160MVA T/F -III (Total 1 breaker)	MAKE-ABB	2/1	HEALTHY	ENABLE TIME DELAY-200 ms	DISABLE	NA
<b>C</b>	<b>132kv system</b>						
<b>1</b>	132KV Kashipur ckt-I&II, Jaspur, Ramnagar , Bazpur I Line, Transformer I,II , TBC(Total 8 breakers)	MAKE-ABB LTB 145D/B SPR	2/1	HEALTHY	ENABLE TIME DELAY-200 ms	DISABLE	NA

Sl. No	Particulars	Make and Model	No. of trip/ close coil	Trip Coil Supervision relay and healthiness of coils	LBB Setting Stage 1	LBB Setting Stage 2	Remarks (If any)
2	132 kV Bazpur II & X-former III (Total 2 breakers)	MAKE-ABB LTB 145D1/B SPR	2/1	HEALTHY	ENABLE TIME DELAY-200 ms	DISABLE	NA

## Current Transformer

<b>a</b>	<b>Location of CT</b>	<b>400 KV NEHTAUR</b>				
<b>b</b>	Date of CT ratio Test Testing					
		Core I	Core II	Core III	Core IV	Core V
<b>c</b>	Accuracy Class	PS	PS	0.2	PS	PS
<b>d</b>	Purpose	BUSBAR PROTECTION	BUSBAR PROTECTION	METERING	21 M2 PROTECTION	21 M1 PROTECTION
<b>e</b>	Test Results					
<b>i</b>	Ratio Adopted	NA	NA	NA	NA	NA
<b>ii</b>	Ratio measured	NA	NA	NA	NA	NA

<b>a</b>	<b>Location of CT</b>	<b>400 KV MORADABAD</b>				
<b>b</b>	Date of CT ratio Test Testing					
		Core I	Core II	Core III	Core IV	Core V
<b>c</b>	Accuracy Class	PS	PS	0.2	PS	PS
<b>d</b>	Purpose	BUSBAR PROTECTION	BUSBAR PROTECTION	METERING	21 M2 PROTECTION	21 M1 PROTECTION
<b>e</b>	Test Results					
<b>i</b>	Ratio Adopted	2000	2000	1000	2000	2000
<b>ii</b>	Ratio measured	NA	NA	NA	NA	NA

<b>a</b>	<b>Location of CT</b>	<b>400 KV SRINAGAR</b>				
<b>b</b>	Date of CT ratio Test Testing					
		Core I	Core II	Core III	Core IV	Core V
<b>c</b>	Accuracy Class	PS	PS	0.2	PS	PS
<b>d</b>	Purpose	BUSBAR PROTECTION	BUSBAR PROTECTION	METERING	21 M2 PROTECTION	21 M1 PROTECTION
<b>e</b>	Test Results					
<b>i</b>	Ratio Adopted	2000	2000	1000	2000	2000
<b>ii</b>	Ratio measured	NA	NA	NA	NA	NA

<b>a</b>	<b>Location of CT</b>	<b>220 KV PANTNAGAR</b>				
<b>b</b>	Date of CT ratio Test Testing					
		Core I	Core II	Core III	Core IV	Core V
<b>c</b>	Accuracy Class	PS	PS	0.2	PS	PS
<b>d</b>	Purpose	BUSBAR PROTECTION	BUSBAR PROTECTION	METERING	21 M2 PROTECTION	21 M1 PROTECTION
<b>e</b>	Test Results					
<b>i</b>	Ratio Adopted	800	800	800	800	800
<b>ii</b>	Ratio measured	NA	NA	NA	NA	NA



<b>a</b>	<b>Location of CT</b>	<b>220 KV JAFARPUR</b>				
<b>b</b>	Date of CT ratio Test Testing					
		Core I	Core II	Core III	Core IV	Core V
<b>c</b>	Accuracy Class	PS	PS	0.2	PS	PS
<b>d</b>	Purpose	BUSBAR PROTECTION	BUSBAR PROTECTION	METERING	21 M2 PROTECTION	21 M1 PROTECTION
<b>e</b>	Test Results					
<b>i</b>	Ratio Adopted	800	800	800	800	800
<b>ii</b>	Ratio measured	NA	NA	NA	NA	NA

<b>a</b>	<b>Location of CT</b>	<b>220 KV SEPL</b>				
<b>b</b>	Date of CT ratio Test Testing					
		Core I	Core II	Core III	Core IV	Core V
<b>c</b>	Accuracy Class	PS	PS	0.2	PS	PS
<b>d</b>	Purpose	BUSBAR PROTECTION	BUSBAR PROTECTION	METERING	21 M2 PROTECTION	21 M1 PROTECTION
<b>e</b>	Test Results					
<b>i</b>	Ratio Adopted	800	800	800	800	800
<b>ii</b>	Ratio measured	NA	NA	NA	NA	NA

<b>a</b>	<b>Location of CT</b>	<b>220 KV MAHUAKHERAGANJ</b>				
<b>b</b>	Date of CT ratio Test Testing					
		Core I	Core II	Core III	Core IV	Core V
<b>c</b>	Accuracy Class	PS	PS	0.2	PS	PS
<b>d</b>	Purpose	BUSBAR PROTECTION	BUSBAR PROTECTION	METERING	21 M2 PROTECTION	21 M1 PROTECTION
<b>e</b>	Test Results					
<b>i</b>	Ratio Adopted	800:1	800:1	800:1	800:1	800:1
<b>ii</b>	Ratio measured	800:1	800:1	800:1	800:1	800:1

<b>a</b>	<b>Location of CT</b>	<b>132 KV Kashipur ckt-I</b>				
<b>b</b>	Date of CT ratio Test Testing					
		Core I	Core II	Core III	Core IV	Core V
<b>c</b>	Accuracy Class	PS	PS	0.2	PS	PS
<b>d</b>	Purpose	BUSBAR PROTECTION	BUSBAR PROTECTION	METERING	21 M2 PROTECTION	21 M1 PROTECTION
<b>e</b>	Test Results					
<b>i</b>	Ratio Adopted	1000:1	1000:1	1000:1	1000:1	1000:1
<b>ii</b>	Ratio measured	1000:1	1000:1	1000:1	1000:1	1000:1

<b>a</b>	<b>Location of CT</b>	<b>132 KV Kashipur ckt-II</b>				
<b>b</b>	Date of CT ratio Test Testing					
		Core I	Core II	Core III	Core IV	Core V
<b>c</b>	Accuracy Class	PS	PS	0.2	PS	PS
<b>d</b>	Purpose	BUSBAR PROTECTION	BUSBAR PROTECTION	METERING	21 M2 PROTECTION	21 M1 PROTECTION
<b>e</b>	Test Results					
<b>i</b>	Ratio Adopted	1000:1	1000:1	1000:1	1000:1	1000:1
<b>ii</b>	Ratio measured	1000:1	1000:1	1000:1	1000:1	1000:1

<b>a</b>	<b>Location of CT</b>	<b>132 KV BAZPUR</b>				
<b>b</b>	Date of CT ratio Test Testing	04/10/2021				
		Core I	Core II	Core III	Core IV	Core V
<b>c</b>	Accuracy Class	PS	PS	0.2	PS	PS
<b>d</b>	Purpose	BUSBAR PROTECTION	BUSBAR PROTECTION	METERING	21 M2 PROTECTION	21 M1 PROTECTION
<b>e</b>	Test Results					
<b>i</b>	Ratio Adopted	1000:1	1000:1	1000:1	1000:1	1000:1
<b>ii</b>	Ratio measured	1000:1	1000:1	1000:1	1000:1	1000:1

<b>a</b>	<b>Location of CT</b>	<b>132 KV JASPUR</b>				
<b>b</b>	Date of CT ratio Test Testing	04/10/2021				
		Core I	Core II	Core III	Core IV	Core V
<b>c</b>	Accuracy Class	PS	PS	0.2	PS	PS
<b>d</b>	Purpose	BUSBAR PROTECTION	BUSBAR PROTECTION	METERING	21 M2 PROTECTION	21 M1 PROTECTION
<b>e</b>	Test Results					
<b>i</b>	Ratio Adopted	1000:1	1000:1	1000:1	1000:1	1000:1
<b>ii</b>	Ratio measured	1000:1	1000:1	1000:1	1000:1	1000:1

<b>a</b>	<b>Location of CT</b>	<b>132 KV RAMNAGAR</b>				
<b>b</b>	Date of CT ratio Test Testing					
		Core I	Core II	Core III	Core IV	Core V
<b>c</b>	Accuracy Class	PS	PS	0.2	PS	PS
<b>d</b>	Purpose	BUSBAR PROTECTION	BUSBAR PROTECTION	METERING	21 M2 PROTECTION	21 M1 PROTECTION
<b>e</b>	Test Results					
<b>i</b>	Ratio Adopted	1000:1	1000:1	1000:1	1000:1	1000:1
<b>ii</b>	Ratio measured	1000:1	1000:1	1000:1	1000:1	1000:1

## Disturbance Recorder (DR) & Event Logger (EL)

Sl. No.	Particulars	400kV	220kV	132kV
1	a) Is the Disturbance recorder and Fault locator provided on all line feeders?	Yes	Yes	Yes
	b) Whether standalone or built in Main relay	Built-In	Built-In	Built-In
	c) Whether DR is having automatic fault record download facility to a central PC	No	No	No
	d) Whether Central PC for DR, EL are powered by Inverter (fed from station DC)	NA	NA	NA
3	Whether substation is having Event logger facility	Yes	Yes	Yes
	If Yes (standalone or built-in-SAS)	Built-In	Built-In	Built-In
4	Whether GPS based time synchronizing equipment is provided at the substation for time synchronizing of Main relays / DR/ Event logger / SAS/ PMU / Line Current Differential Relays	Yes 2 Nos. (one for SAS & one for Relays/Equipment)		

## Communication System

Sl. No.	Name of Line Feeder	PLCC/OPGW /none	If PLCC for protection (y/n)	Coupling type & no. Of channel	If OPGW for protection (y/n)	Geographically distributed for main-1 & main-2 dedicated/ multiplexed
1	400KV Kashipur-Nehtaur Line	PLCC	Yes	Ph-Ph	No	NA
2	400KV Kashipur-Moradabad line	PLCC	Yes	Ph-Ph	No	NA
3	400KV Kashipur-Srinagar Line	NA	NA	NA	NA	NA
4	220KV Kashipur-Jafarpur Line	PLCC	Yes	Ph-Ph 2 channels	No	NA
5	220KV Kashipur-Pantnagar Line	PLCC & OPGW	No	Ph-Ph	Yes	Dedicated, Dedicated
6	220KV Kashipur-Mahuakheraganj Line	PLCC	Yes	Ph-Ph 2 channels	No	NA
7	220KV Kashipur-SEPL Line	PLCC	Yes	Ph-Ph 2 channels	No	NA
6	132KV Kashipur ckt-I Line	PLCC	No	Ph-G	No	NA
7	132KV Kashipur ckt-II Line	PLCC	No	Ph-G	No	NA
8	132kv Jaspur line	PLCC	No	Ph-G	No	NA
9	132KV Bazpur Line	PLCC	No	Ph-G	No	NA
10	132kv Ramnagar line	PLCC	No	Ph-G	No	NA

# Network Diagram of Uttarakhand

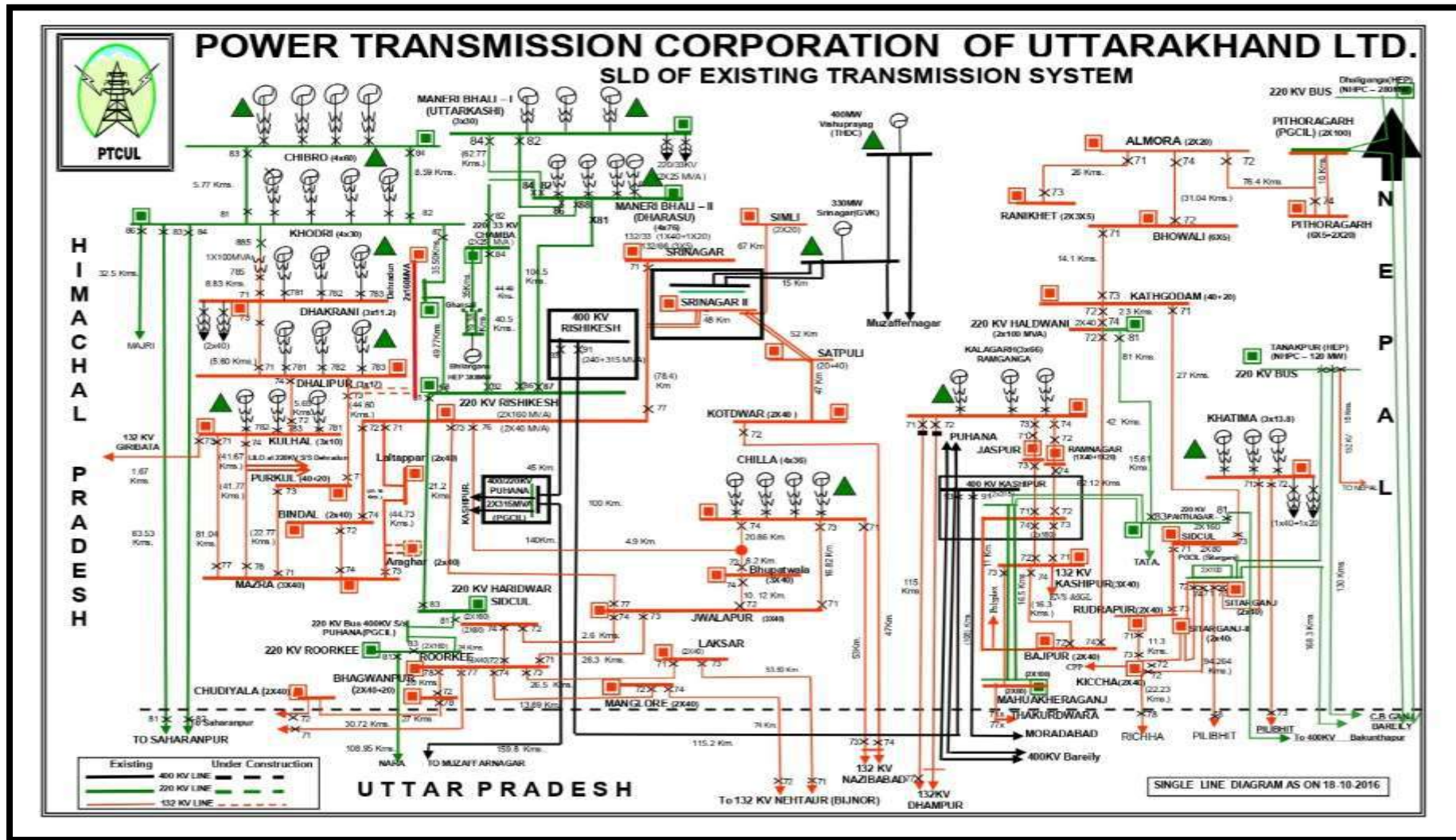



# Power Map of Uttarakhand







# **Power Transmission Corporation of Uttarakhand Limited**

(A Govt. of Uttarakhand Undertaking)

Corporate ID No.: U40101UR2004SGC028675

## **FINAL REPORT**

### **Protection Audit**

#### **220/132KV Mahuakheraganj Substation**

**Submitted**

**By**



**CENTRAL BOARD OF IRRIGATION & POWER**

**NEW DELHI**



# केन्द्रीय सिंचाई व शक्ति मंडल CENTRAL BOARD OF IRRIGATION AND POWER

25<sup>th</sup> June 2024

Order No.: 376/SE (T&C)/PTCUL/(H). dated: 29.09.2023

## Protection Audit Report

FINAL PROTECTION AUDIT REPORT OF 220/132/33 KV MAHUAKHERAGANJ SUB-STATION UNDER POWER TRANSMISSION CORPORATION OF UTTARAKHAND LIMITED (PTCUL), UTTARAKHAND.

Submitted  
To



**Power Transmission Corporation of Uttarakhand Limited**

(A Govt. of Uttarakhand Undertaking)

Corporate ID No.: U40101UR2004SGC028675

# Contents

<b>Disclaimer</b> .....	6
<b>1.0. Executive Summary</b> .....	7
<b>2.0. Introduction</b> .....	9
2.1. <i>Background</i> .....	9
2.2. <i>Scope of Work</i> .....	10
2.3. <i>Audit Rationale</i> .....	10
2.4. <i>Audit Process</i> .....	11
2.5. <i>About Power Transmission Corporation of Uttarakhand (PTCUL)</i> .....	13
2.6. <i>About Central Board of Irrigation &amp; Power (CBIP)</i> .....	14
<b>3.0. Preliminary Audit of Mahuakheraganj Substation</b> .....	15
3.1. <i>General Information about Substation</i> .....	15
3.2. <i>Audit Team</i> .....	15
3.3. <i>Recommendation of last protection checking and validation</i> .....	16
3.4. <i>Review of existing settings at substation</i> .....	16
3.5. <i>Disturbance Recorder availability for the last 6 tripping's</i> .....	16
3.6. <i>Chronic reason of tripping, if any</i> .....	16
3.7. <i>Major non-conformity/deficiency observed</i> .....	16
<b>4.0. List of Trippings</b> .....	17
<b>5.0. Observations and Recommendations</b> .....	18
5.1. <i>Reporting of all the Tripping with DR/EL</i> .....	18
5.2. <i>Development of centralized database of relay settings</i> .....	18
5.3. <i>Review of test results of relay and equipment</i> .....	19
5.4. <i>Availability of Testing Kits</i> .....	19
5.5. <i>Up-dation of PTCUL Protection Philosophy</i> .....	19
5.6. <i>Simulation based study of protection system</i> .....	19
5.7. <i>Capacity Building of protection team</i> .....	20
5.8. <i>Updated Fault Level/ Short Circuit Level and Network information</i> .....	20
5.9. <i>General Protection related observations</i> .....	20
5.10. <i>O&amp;M Manual</i> .....	20
<b>6.0. Station Specific Observation and Recommendations</b> .....	21
6.1. <i>Protection related observations and recommendations</i> .....	21
6.2. <i>Equipment related observations and recommendations</i> .....	21
6.3. <i>Auxiliary Equipment related observations and recommendations</i> .....	21
<b>Annexure – 1: Suggested List of Testing Instruments</b> .....	23
<b>Annexure – 2: Suggested List of Substation Equipments</b> .....	24

<b>Annexure – 3: Suggested List of Maintenance Equipments.....</b>	<b>25</b>
<b>Annexure – 4: Protection Code (IEGC 2023 Chapter 4).....</b>	<b>26</b>
<b>Annexure – 5: Third Party Protection System Checking &amp; Validation Template for a Substation (IEGC 2023 Annexure – 1).....</b>	<b>31</b>
<b>Annexure – 6: Protection Philosophy/Protocol of Northern Region .....</b>	<b>36</b>
<b>Annexure – 7: Work Order &amp; Corrigendum.....</b>	<b>42</b>
<b>Annexure – 8: Data Sheets .....</b>	<b>50</b>

## ACRONYMS

<b>A</b>	Ampere
<b>AC</b>	Alternating Current
<b>AMP</b>	Annual Maintenance Plan
<b>CBIP</b>	Central Board of Irrigation and Power
<b>CT</b>	Current Transformer
<b>CVT</b>	Capacitive Voltage Transformer
<b>DC</b>	Direct Current
<b>DG</b>	Diesel Generator
<b>DPR</b>	Detailed Project Report
<b>DR</b>	Disturbance Recorder
<b>EL</b>	Event Logger
<b>EMTP</b>	Electromagnetic Transient Program
<b>EE</b>	Executive Engineer
<b>GPS</b>	Global Positioning System
<b>ICT</b>	Inter Connecting Transformer
<b>IEGC</b>	Indian Electricity Grid Code
<b>JE</b>	Junior Engineer
<b>KA</b>	Kilo Ampere
<b>KV</b>	Kilo Volt
<b>LBB</b>	Local Breaker Backup
<b>LEFT</b>	Earth Fault
<b>MVA</b>	Mega Volt Ampere
<b>NA</b>	Not Available
<b>NRPC</b>	Northern Regional Power Committee
<b>O&amp;M</b>	Operation & Maintenance
<b>OCC</b>	Operation Coordination Sub Committee

<b>PLCC</b>	Power Line Carrier Communication
<b>PSC</b>	Power System Sub Committee
<b>PSDF</b>	Power System Development Fund
<b>PT</b>	Potential Transformer
<b>PTCUL</b>	Power Transmission Corporation of Uttarakhand Limited.
<b>RLDC</b>	Regional Load Dispatch Centre
<b>RPC</b>	Regional Power Committee
<b>SAS</b>	Substation Automation System
<b>SE</b>	Superintendent Engineer
<b>SCADA</b>	Supervisory Control & Data Acquisition
<b>SLD</b>	Single Line Diagram
<b>SLDC</b>	State Load Dispatch Centre
<b>SOTF</b>	Switch On-To Fault
<b>SPS</b>	Special Protection Scheme
<b>T&amp;C</b>	Testing & Commissioning
<b>UJVNL</b>	Uttarakhand Jal Vidyut Nigam Ltd
<b>UPCL</b>	Uttarakhand Power Corporation Ltd
<b>WTI</b>	Winding Temperature Indicator

## Disclaimer

The protection audit has been carried out based on the guidelines provided under various documents mentioned in the report. For the purpose of audit, the auditor(s) have relied upon the data made available by the client and information & clarifications made available, in the written or verbal form, by the officials of clients during site visit and later.

The report is not for public distribution and has been furnished solely for information and must not be reproduced or redistributed to others, except those concerned. No one can use the report as a base for any claim, demand or cause of action and, also no one is responsible for any loss incurred based upon the content of this report.

While every effort is made to ensure the accuracy and completeness of information contained, CBIP takes no responsibility and assumes no liability for any error/ omission or accuracy of the information. Recipients of this material should rely on their own judgments and conclusions from relevant sources before taking any decision.

## 1.0. Executive Summary

PTCUL awarded the work of Third-Party Protection Audit of 2 nos. 400kV and 8 nos. 220kV substations of PTCUL (“Utility”) to CBIP. CBIP planned the audit as per Audit process provided under Protection Code within Indian Electricity Grid Code 2023. In addition, the guidelines of Ramakrishna Committee for checking and validation and NRPC guidelines for Third Party Audit were also adhered too. The CBIP manual on protection (manual no 247-Revised), NRPC protection philosophy were also referred too.

As a part of audit process, utility was asked to provide set of information before start of audit. Team from CBIP consisting of Mr. Vijay Barthwal, Mr. M.R. Chauhan & Mr. Rounak Sen visited 220/132/33KV Mahuakheraganj Substation during 29<sup>th</sup> – 31<sup>st</sup> January 2024 and preliminary audit report was submitted on the spot. The representatives of utility were present during this process. Some more information was sought from the Utility.

Based on the data made available by Utility, draft of final report was submitted to Utility and after discussions, report was finalized. The details of audit process, data made available by Utility, observations from preliminary report and detailed observations and recommendations are provided in this report. Key observations and recommendations are summarized below under 2 heads.

### **General Observations and Recommendations for Organization Level implementation**

01. It is recommended that each substation to have a central repository for tripping reports, along with Time Synchronized DR/EL reports and analysis. A dedicated PC can be provided at each substation for the purpose.
02. The protection philosophy adopted by Utility, in general, is in alignment with protection philosophy adopted by NRPC. As the NRPC has recently updated the protection philosophy, PTCUL in consultation with SLDC may update protection philosophy for network not covered by NRPC too, if needed, and implement the same.
03. It is recommended that latest recommended relay settings, as per the NRPC protocol for 220KV & above Substations, along with setting calculations & parameters used for all the relays, be kept at each substation. This will help in proper fault analysis and ascertaining relay healthiness. Similarly, Relay settings for sub-stations below 220kV, based on any such protocol by SLDC, along with setting calculations and line parameters also needs to be maintained.
04. It is recommended that the detailed reports of test results for the relays and switchyard equipments be maintained at sub-station level.



05. Based on “Draft O&M Manual” of PTCUL and discussions with their officials, a list of testing equipment is suggested and enclosed at Point 5.4. It is recommended that the necessary testing equipment at substation/Sub-division/Division be arranged for regular testing of equipment at substations.
06. Simulation based studies or EMTP Studies should be carried out by the Utility, as per the requirement of IEGC.
07. For the protection system and SAS, PTCUL may undertake capacity building exercise for the officials involved in these activities.
08. It is recommended that the updated network information and short circuit level should be periodically reviewed and maintained at central level for revising the setting as per requirement.
09. It is suggested that utility may carry out exhaustive safety and technical audit of sub-stations apart from protection audit, either internally or thru’ third party for implementing the best practices in the sub-station.
10. In addition, the existing draft O&M manual also be updated to take care of latest developments.

#### **Observations and Recommendations for 220/132/33 KV Mahuakheraganj Substation**

01. This is a new Sub-station and first protection audit is being conducted.
02. SAS is fully functional. It is suggested that the connectivity of SAS with printer and/or network be ensured for accessing data outside SAS.
03. Bus-bar protection is not functional. It is recommended that Bus-bar protection be made functional.
04. Both the lines are operating in radial mode and Carrier aided protection is not provided. It is suggested that based on protection philosophy and importance of lines, PTCUL study the need of carrier aided protection.
05. Due to fault on 33kV Network, LV side of transformers tripped in multiple instances. It is recommended that Protection co-ordination with distribution company (UPCL) be carried out.
06. The SLD of DC system be kept easily accessible.
07. Earth Fault in one 220V battery bank was observed. It is recommended to take necessary corrective action.
08. Emergency DG set operation is in manual mode. It is suggested to keep the DG set in Auto mode.
09. It is suggested that the possibility of connecting the available spare transformer to 33kV system, as second auxiliary supply source be considered.

## 2.0. Introduction

### 2.1. Background

The work has been awarded to the Central Board of Irrigation & Power (CBIP) vide Work Order Number: 376/SE (T&C)/PTCUL/(H), dated: 29.09.2023 for Protection Audit of 02 Nos. 400 kV and 08 Nos. 220 kV Sub-Stations at Uttarakhand, for Power Transmission Corporation of Uttarakhand Limited (PTCUL) in reference to the offer submitted by CBIP to PTCUL vide ref. no. P-1/CBIP/PTCUL/Audit/2023, dated: 11.09.2023. A Kick-Off Meeting was held between PTCUL and CBIP at the office of SE (T&C), PTCUL, Kathgodam, Haldwani on 26<sup>th</sup> October 2023. Detailed discussions were held regarding process and methodology of Execution and Submission of reports of Protection Audit. As per the above-mentioned meeting, a corrigendum was released by PTCUL vide ref. no. 394/SE (T&C)/PTCUL/(H), dated: 26.10.2023.

**As per the given order, the protection audit of following substations is to be carried out**

1. *400kV Rishikesh*
2. *400kV Kashipur*
3. *220kV Chamba*
4. *220kV Rishikesh*
5. *220kV Roorkee*
6. *220kV Haridwar (SIDCUL)*
7. *220kV Jhajra*
8. *220kV Pantnagar*
9. *220kV Haldwani*
10. *220kV Mahuakheraganj*

## **2.2. Scope of Work**

Review of the implemented protection schemes/philosophy for 400/220 kV substations which includes protection of transmission lines, interconnecting transformers, line/bus reactors, bus bar, bus couplers etc. with respect to tripping in last one year as per latest guidelines of Ramakrishna committee/ CBIP/NRPC/International best practices, which includes review of the following:

- a. Adequacy of primary and backup protection settings for protected equipment and suggest corrective measures.*
- b. Availability/healthiness of PLCC communication links used for protection systems.*
- c. Healthiness/adequacy of 220/110/50V DC system available at substations for protection application.*
- d. Availability/healthiness of GPS system and time synchronization facility used for protection.*
- e. Availability/healthiness of recording instruments like DRs /ELs for transmission lines protection.*
- f. Test reports for assessing the healthiness of circuit breakers, CT & CVT based upon available test reports at sites.*
- g. Field inspection of protection device for obsolescence of technology, suitability and healthiness.*
- h. Prepare recommendation for replacement of obsolescence relays with compatible numerical relays will be provided.*
- i. Checking of availability of DG Set / auxiliary DC supply at substations.*

## **2.3. Audit Rationale**

- a. PTCUL (Utility) has submitted a DPR for Replacement of certain equipment under PSDF scheme to Grid-India. Grid-India has asked PTCUL to carry out protection audit of certain substations.
- b. In addition, as per CERC IEGC 2023 Chapter-04 (Protection Code) Para - 15 (2) “All users shall also conduct third party protection audit of each substation at 220KV and above (132KV and above in NER) once in 5 years or earlier as advised by the respective RPC”.
- c. As per Para – 15 (4) of said Code, “The third-party protection audit report shall contain information sought in the format enclosed as Annexure–1. The protection audit reports, along with action plan for rectification of deficiencies detected, if any, shall be submitted to the

respective RPC and RLDC or SLDC, as the case may be, within a month of submission of third-party audit report. The necessary compliance to such protection audit report shall be followed up regularly in the respective RPC”.

- d. Subsequently NRPC issued protection philosophy for Northern region developed in compliance of IEGC 2023, Version 2.0 which was approved in 71<sup>st</sup> NRPC meeting held on 29.01.2024.

Accordingly, protection audit of 220KV and above Substations is being carried out by CBIP, as per Annexure -1 of IEGC-2023.

## 2.4. *Audit Process*

- PTCUL shall provide the following documents:
  - a. The Network Diagram, covering the relevant assets
  - b. Latest relay settings adopted and calculations for respective sub-stations and transmission lines.
  - c. Annual maintenance plan (AMP), including the schedule and activities covered under AMP
  - d. Any specific issues covered under OCC and/or PSC of NRPC for relevant assets.
- For each sub-station, check-list shall be provided by PTCUL. During field visit, the information shall be verified.
- The minimum set of points on which checking and validation shall be carried out is provided as per annexure - 4 for the following available power system elements at station, as per attached formats:

S. No.	Elements
1	Transmission Line
2	Bus Reactor/Line Reactor
3	Inter-Connecting Transformer [ICT]
4	Busbar
5	AC auxiliary system
6	DC auxiliary system
7	Communication system

S. No.	Elements
8	Circuit Breaker Details
9	Current Transformer Details
10	Capacitive Voltage Transformers Details
11	Any other equipment/system relevant for protection system operation

- During field visit, no testing of equipment and relay shall be carried out. The visual inspection, operational log shall be considered for audit purpose, apart from the documents provided by PTCUL
- A calibrated multi-meter shall be provided at sub-station for checking AC and DC voltages and currents online, wherever feasible, without impacting the sub-station operations.
- The preliminary report shall be prepared on the site and shall be signed by all the parties present, as given below:

S. No.	Issues	Remarks
1	Recommendation of last protection checking and validation	Status of works and pending issues if any
2	Review of existing settings at substation	Recommended Action
3	Disturbance Recorder out/ available for last 6 tripping's (Y/N)	Recommended Action
4	Chronic reason of tripping, if any	Recommended Action
5	Major non-conformity / deficiency observed	Recommended Action

- **The Final summary shall specifically mention minimum following points:**
  - The settings and scheme adopted are in line with agreed protection philosophy or any accepted guidelines (e.g., Ramakrishna guidelines or CBIP manual based).
  - The deviations from the RPC protection philosophy, if any and reasons for taking the deviations shall be recorded.
  - All the major general deficiency shall be listed in detail along with remedial recommendations.

- The cases of protection maloperation (last 1 year) shall be analysed from tripping reports and the causes of failure along with corrective actions and recommendations based on the findings.

## **2.5. *About Power Transmission Corporation of Uttarakhand (PTCUL)***

The State of Uttarakhand's power transmission utility, PTCUL, was formerly known as Uttaranchal. According to the Uttar Pradesh State Reorganization Act 2000, this 27<sup>th</sup> state of the republic of India was formed on November 9, 2000, by dividing the Himalayan and surrounding North-Western districts of Uttar Pradesh.

The State of Uttaranchal in exercise of the power granted to it under section 63(4) of the State Re-Organization Act, 2000, formed two separate companies in power sector:

- Uttaranchal Jal Vidyut Nigam Ltd. (UJVNL) – For generation of Hydro-Electricity in the State.
- Uttaranchal Power Corporation Ltd. (UPCL) – For Transmission and Distribution of Electricity in the state.

Enactment of the Electricity Act 2003, a distinct watershed in the Indian Power Sector, made it mandatory for all the States to restructure their SEBs. As per the provisions of Electricity Act 2003, the State Government separated power transmission business from UPCL which was left only with distribution of electricity.

In order to manage Power Transmission Operations, a new company called Power Transmission Corporation of Uttaranchal Ltd. was established. On 27<sup>th</sup> May, 2004, the firm was formed as a Government Company in accordance with section 617 of the Companies Act, 1956. It began operating from 1<sup>st</sup> June, 2004.

The company's corporate and registered office is located in Vidyut Bhawan, Saharanpur Road, Majra, Dehradun, next to the ISBT Crossing.

## ***2.6. About Central Board of Irrigation & Power (CBIP)***

The Government of India established the Central Board of Irrigation and Power in 1927, making it a Premier Institution. For the past 93 years, CBIP has provided committed services to the nation's professional associations, engineers, and individuals involved in the power, water resources, and renewable energy sectors. While serving the country equally and to great honour, CBIP has developed into an esteemed institution of international significance. CBIP is Indian chapter for 10 international organizations related to Power & Water resources sectors.

CBIP is involved in executing various activities such as, International Conferences, Technical Documents Publications, Training Activities, Research & Development, Consultancy Services including Technical, Protection & Safety Audits.

### 3.0. Preliminary Audit of Mahuakheraganj Substation

#### 3.1. General Information about Substation

Sl. No.	Particulars	Details
1	Substation Name	220/132/33 KV Mahuakheraganj Substation
2	Name of Owner Utility	Power Transmission Corporation of Uttarakhand Limited (PTCUL)
3	Voltage Level (s) or highest voltage level	220/132/33 KV
4	Short circuit current rating of all equipment (for all voltage level)	50kA
5	Date of commissioning of the substation	24 <sup>th</sup> November 2011
6	Checking and validation date	29 <sup>th</sup> – 31 <sup>st</sup> January 2024

#### 3.2. Audit Team

**Audit Team (CBIP):**

- Mr. Vijay Barthwal
- Mr. M.R. Chauhan
- Mr. Rounak Sen

**PTCUL Representative:**

- Mr. Asim Baig – Executive Engineer
- Mr. Ashutosh Pokhriyal – Assistant Engineer
- Mr. Amit Goyal – Junior Engineer



### ***3.3. Recommendation of last protection checking and validation***

No Protection Audit was conducted previously

### ***3.4. Review of existing settings at substation***

- a. Utility has provided relay settings adopted for various feeders and transformers.
- b. The record of different relay setting calculations is not available at the substation level.
- c. All relays are numeric, therefore, as per internal protocol of utility relays are tested only at the time of commissioning/change in setting. Copy of test reports not available at sub-station level.

### ***3.5. Disturbance Recorder availability for the last 6 tripping's***

- a. Relays are connected to central PC and DR data and events can be accessed.
- b. Complete sub-station is operated thru SAS system and Events can be recorded/ accessed.

### ***3.6. Chronic reason of tripping, if any***

- a. At 220 and 132 kV level no significant trippings are noticed.
- b. Few 33kV lines are showing very high number of tripping and in many cases 33kV Side of transformers are also tripping, due to non-directional O/C & E/F relay operations, when 33kV lines trip.

### ***3.7. Major non-conformity/deficiency observed***

- a. One 220V DC systems is showing earth-fault.
- b. Emergency DG set operation is in manual mode
- c. SAS output is not accessible either on printer or network or external disks. The output is taken as photographic image.
- d. One 33kV/440 V station transformer, to be used as 2<sup>nd</sup> source of Aux AC, is kept back charged near 100 MVA 220/132/33 transformer. It can be connected to tertiary end for improving the reliability.
- e. Recommended relay settings with supporting calculations/ parameters needs to be kept at sub-station.
- f. PLCC is not functional.

## 4.0. List of Trippings

Sl. No	Name of Feeder/TF& CB	Type of relay/Scheme	Date & Time of tripping	Date & Time of closing	Flags observed	Other End flags	Affected Generation /Load	Tripping Analysis/Action taken Report
1	132kV Kashipur Line	GE	17-10-2023 05:28 HRS	17-10-2023 11:15 HRS	Zone 1 trip, Dist-5 Km, Fault Loop-A-N, Fault Current- Ia-4676.105 A, Ib-44.693 A, Ic-141.516 A, In-4491.693 A	Other End not tripped	NA	Due to R phase Jumper broken
2	132KV Thakurdwara line	GE D60	18-05-2023 04:00 HRS	18.03.2023, 11.15 hrs	R, Y, B, O/C E/F 86A, 86B Ia - 5.204 KA, Ib-5.204 KA, Ic -4 A, In- 8 A, Vab-70.272 KV, Vbc-126.048KV, Vc-135.744 Kv	No Flag, Circuit breaker is opened at other end i.e. 132 KV Thakurdwara , and Line is charged from PTCUL end.	Not Affected	TLF, Due to heavy storm, distance not tripped. It was blocked by VT fuse fail and PSB
3		GE D60	18.03.2023, 10:02 Hrs	18.03.2023, 12:00 Hrs	R, Y, B, O/C E/F 86A, 86B Ia - 4.393 A, Ib 7178.345 A, Ic -7179.408 A, In-5.884 A, Va-75.886 KV, Vb 44.169KV, Vc-38.182 KV, dist-4.7 km, Zone 1 trip	No Flag, Circuit breaker is opened at other end i.e. 132 KV Thakurdwara , and Line is charged from our end.	Not Affected	TLF

## 5.0. Observations and Recommendations

### 5.1. Reporting of all the Tripping with DR/EL

- a. For the interstate lines, as per IEGC clause 37.2(c) and clause 15.3 of CEA grid standard, all the DR/EL reports shall be uploaded on Web Based Tripping Monitoring System “http://103.7.128.184/Account/Login.aspx” within 24 hours of the events. These are being submitted by sub-station to NRLDC portal, however the record of the same is not kept at sub-station level.

Status of submission of FIR/DR/EL/Tripping Report on NR Tripping Portal																								
Time Period: 1st January 2024 - 31st January 2024																								
S. No.	Utility	Total No. of tripping	First Information Report (Not Received)		Disturbance Recorder (Not Received)		Disturbance Recorder (NA) as informed by utility		Disturbance Recorder (Not Received)		Event Logger (Not Received)		Event Logger (NA) as informed by utility		Event Logger (Not Received)		Tripping Report (Not Received)		Tripping Report (NA) as informed by utility		Tripping Report (Not Received)		Remark	
			Value	%	Value	%	Value	%	Value	%	Value	%	Value	%	Value	%	Value	%						
36	SLDC-PS	29	2	7	13	6	57	13	5	54	36	0	55											
37	SLDC-RS	130	12	9	23	11	19	23	9	39	39	0	30											DR, EL & Tripping report need to be submitted
38	SLDC-LK	6	0	0	0	4	0	0	4	0	1	3	33											
39	SLDC-LP	80	10	13	11	9	15	12	10	17	11	1	14											
40	STERLITE	1	0	0	0	0	0	0	0	0	0	1	0											Details received
41	TANAKPUR-NH	4	1	25	1	0	25	1	0	25	1	0	25											DR, EL & Tripping report need to be submitted
42	UMCHAHAR-NT	1	0	0	0	0	0	0	1	0	0	0	0											Details received
Total in NR Region		520	147	28	169	69	37	171	70	38	185	17	37											

As per the IEGC provision under clause 37.2 (c), detailed tripping report along with DR & EL has to be furnished within 24 hrs of the occurrence of the event

Ref: NRPC 216 OCC Agenda (Annexure B.VIII)

- b. For the tripping of intra-state lines, the brief tripping reports are submitted to Divisional office. The DR/EL reports are downloaded by respective officials and forwarded, as per need basis. The record of these DR/EL is not kept at sub-stations
- c. It is recommended that each sub-station to have a central repository of such tripping reports, along with DR/EL reports and analysis. A dedicated PC can be kept for this.

### 5.2. Development of centralized database of relay settings

- a. In 48th TCC & 70th NRPC Meeting (held on 17-18 Nov 2023), NRPC Committee has approved for development of a portal through PSDF for Centralized database containing details of relay settings for grid elements connected to 220 kV and above. Portal shall have other features including protection setting calculation tool. A nodal officer shall be providing this data at central portal.
- b. The relay settings for below 220kV are to be calculated by SLDC and/or central level. The relays are tested by sub-station officials as per need basis, but the record of recommended settings/ calculation is not kept at sub-station level. This makes it difficult to validate the settings and test results, in case of relay testing.

- c. It is recommended that latest recommended relay settings, as decided by RLDC for 220kV & above and by SLDC below 220kV along with setting calculations & parameters used for all the relays be kept at sub-station level. This will help in proper fault analysis and ascertaining relay healthiness.

### **5.3. *Review of test results of relay and equipment***

- a. Testing of most of the equipment is carried out, as per availability of shut-down and testing equipment. After testing, the test records are summarily recorded in testing register, with remarks as “tested. OK”.
- b. For the numeric relay testing, the testing is carried out by supplier at the time of installation and subsequently as per need basis, including at the time of change in settings.
- c. A draft O&M manual is available at PTCUL web-site, which includes various tests and their frequency, along with results. This manual is based on CERC/SERC regulations of 2004-2008. It is recommended that this manual may be updated and implemented and record of test values may be kept for future reference.

### **5.4. *Availability of Testing Kits***

- a. The availability of testing equipment is limited at each sub-station is limited. For comprehensive testing of equipment, as per above para, sufficient testing kits at each sub-station/Sub-division/Division level are required.
- b. It is recommended that based on approved O&M manual, station, Sub-division, Division wise testing instruments be arranged for regular testing of equipment.

### **5.5. *Up-dation of PTCUL Protection Philosophy***

The protection philosophy adopted by Utility, in general, is in alignment with protection philosophy adopted by NRPC. As the NRPC has recently updated the protection philosophy, PTCUL in consultation with SLDC may update protection philosophy for network not covered by NRPC, if needed, and implement the same.

### **5.6. *Simulation based study of protection system***

As per IEGC, protection code, during audit the relay settings to be adopted shall be validated with simulation based or EMTP studies and details shall be enclosed in report. The current scope of audit was excluding these studies, therefore, Simulation based or EMTP Studies should be carried out by the Utility, as per the requirement of Grid Code.

### **5.7. Capacity Building of protection team**

During the discussions with officials at site, it was observed that the teams responsible for the protection system and SAS, needs to be updated on current trends on protection system, communication schemes and Sub-station automation. Utility may undertake capacity building exercise for the officials involved in these activities.

### **5.8. Updated Fault Level/ Short Circuit Level and Network information**

The fault level/ short circuit level for each substation is being calculated at central level. Such studies are carried out, as and when new elements are added in the network. This has impact on relay settings parameters and equipment ratings. It is recommended that the updated network information and short circuit level be maintained at central level for revising the setting as per requirement.

### **5.9. General Protection related observations**

The study of Fire protection system/ Nitrogen Injection Fire Protection System, Lightning Protection system, Earthing Mat/ Earthing Protection are not covered under protection audit. Utility may get a comprehensive technical and safety audit carried out internally or thru third party and corrective action for any discrepancy be taken up accordingly.

### **5.10. O&M Manual**

The Utility has a draft O&M manual uploaded on its website, which is being referred by working level officials as a guideline for regular O&M and testing functions. This manual needs to be updated to incorporate recent developments and approved for regular use in all sub-stations to bring uniformity in O&M and testing practices across the utility.

## **6.0. Station Specific Observation and Recommendations**

### **6.1. Protection related observations and recommendations**

- a. Complete sub-station is operated thru SAS system and Events can be recorded/ accessed on SAS terminal. SAS output is not accessible either on printer or network or external disks. The output is taken as photographic image. Necessary Connectivity of SAS terminals to network/ printer may be arranged.
- b. For both 220kV and 132 kV, the Bus-bar protection relays were replaced, but are not compatible with Bay Units. Therefore, bus bar protection system is out of service. Utility has informed that zone IV of all distance protection is set in reverse direction and 160 ms (less than zone 2 time), in the absence of bus-bar protection.
- c. Carrier based protection is not functional in any line, as PLCC is not functional. It is recommended that Carrier aided protection be made functional in 220kV lines.
- d. At 220 and 132 kV level no significant trippings are noticed. Few 33kV lines are showing very high number of tripping and in many cases 33kV Side of transformers are also tripping. The 33kV system beyond the 33kV side of transformers is owned by distribution company, i.e. UPCL. Any fault in 33kV and/or 11kV, if not cleared in time, can cause tripping of LV side of transformer, as the non-directional Over current and Earth Fault protection is provided.

### **6.2. Equipment related observations and recommendations**

This is a new sub-station and equipment are generally in good condition. Any requirement of spare equipment may be reviewed by PTCUL.

In addition, it is recommended that sufficient quantity of maintenance equipments be made available at sites. A suggested list of Maintenance Equipment is attached at Annexure – 3.

### **6.3. Auxiliary Equipment related observations and recommendations**

- a. Single Line diagram of DC system not available. It is recommended to keep the SLD easily accessible.
- b. One of the 220V DC system is showing severe earth-fault. The necessary corrective action needs to be taken asap to avoid any unwanted tripping in future.
- c. Emergency DG set operation is in manual mode. Necessary action may be taken to keep the DG set in Auto mode.

- d. One 33kV/440 V station transformer, to be used as 2<sup>nd</sup> source of Aux AC, is kept back charged near 100 MVA 220/132/33 transformer. It can be connected to tertiary end for improving the reliability.

## Annexure – 1: Suggested List of Testing Instruments

CBIP suggests the following list of testing instruments based on the approved O&M manual

Sl. No.	Testing Instruments
1	DCRM for Circuit Breaker
2	DC Earth Fault Locator
3	SF6 Gas Density Monitor
4	SF6 Gas Leakage detector/ Imaging Camera
5	CB Analyser
6	Earth Resistance Tester
7	Portable Digital Selective Level Meter cum Level Generator
8	Selective Level Generator
9	LA Leakage Current Analyser
10	Digital Multi-meter
11	Tong Tester
12	Tan Delta Test Kit
13	Digital Leakage Clamp Meter
14	Phase Sequence Indicator
15	Megger (5 kV)
16	Digital Capacitance Meter
17	CT Polarity Tester
18	PT Test Set



## **Annexure – 2: Suggested List of Substation Equipments**

**NIL**

### Annexure – 3: Suggested List of Maintenance Equipments

Sl. No.	Equipment
1	Oil Filter Machine
2	SF6 Gas Handling Plant
3	SF6 Gas Density Monitor
4	Thermo-Vision Camera Lines and Sub-Station
5	Binocular Vision Camera
6	SF6 Gas Leakage Imaging Camera
7	LA Leakage Current Analyser
8	Online DGA
9	Oil BDV Kit
10	Hydraulic Crimping Tool for different Types of ACSR Conductor
11	Hydraulic Conductor Cutter
12	Fork Lift 5 Ton Capacity
13	Digital Leakage Clamp Meter

A mobile van with test kits can be kept for optimizing the resources at various substations

## Annexure – 4: Protection Code (IEGC 2023 Chapter 4)

- **General**

1. This chapter covers the protection protocol, protection settings and protection audit plan of electrical systems.
2. There shall be a uniform protection protocol for the users of the grid:
  - a) for proper co-ordination of protection system in order to protect the equipment/system from abnormal operating conditions, isolate the faulty equipment and avoid unintended operation of protection system;
  - b) to have a repository of protection system, settings and events at regional level;
  - c) specifying timelines for submission of data;
  - d) to ensure healthiness of recording equipment including triggering criteria and time synchronization; and
  - e) to provide for periodic audit of protection system.

- **Protection protocol**

1. All users connected to the integrated grid shall provide and maintain effective protection system having reliability, selectivity, speed and sensitivity to isolate faulty section and protect element(s) as per the CEA Technical Standards for Construction, the CEA Technical Standards for Connectivity, the CEA (Grid Standards) Regulations, 2010, the CEA Technical Standards for Communication and any other applicable CEA Standards specified from time to time.
2. Back-up protection system shall be provided to protect an element in the event of failure of the primary protection system.
3. RPC shall develop the protection protocol and revise the same, after review from time to time, in consultation with the stakeholders in the concerned region, and in doing so shall be guided by the principle that minimum electrical protection functions for equipment connected with the grid shall be provided as per the CEA Technical Standards for Construction, the CEA Technical Standards for Connectivity, the CEA Technical Standards for Communication, the CEA (Grid Standards) Regulations, 2010, the CEA (Measures relating to Safety and Electric Supply) Regulations, 2010, and any other CEA standards specified from time to time.
4. The protection protocol in a particular system may vary depending upon operational experience. Changes in protection protocol, as and when required, shall be carried out after deliberation and approval of the concerned RPC.

5. Violation of the protection protocol of the region shall be brought to the notice of concerned RPC by the concerned RLDC or SLDC, as the case may be.

- **Protection settings**

1. RPCs shall undertake review of the protection settings, assess the requirement of revisions in protection settings and revise protection settings in consultation with the stakeholders of the respective region, from time to time and at least once in a year. The necessary studies in this regard shall be carried out by the respective RPCs. The data including base case (peak and off-peak cases) files for carrying out studies shall be provided by RLDC and CTU to the RPCs:

2. All users connected to the grid shall:

- a) furnish the protection settings implemented for each element to respective RPC in a format as prescribed by the concerned RPC;
- b) obtain approval of the concerned RPC for,
  - i. any revision in settings, and,
  - ii. implementation of new protection system;
- c) intimate to the concerned RPC about the changes implemented in protection system or protection settings within a fortnight of such changes;
- d) ensure correct and appropriate settings of protection as specified by the concerned RPC.
- e) ensure proper coordinated protection settings.

3. RPCs shall:

- a) maintain a centralized database and update the same on periodic basis in respect of their respective region containing details of relay settings for grid elements connected to 220 kV and above (132 kV and above in NER). RLDCs shall also maintain such database.
- b) carry out detailed system studies, once a year, for protection settings and advise modifications / changes, if any, to the CTU and to all users and STUs of their respective regions. The data required to carry out such studies shall be provided by RLDCs and CTU.
- c) provide the database access to CTU and NLDC and to all users, RLDC, SLDCs, and STUs of the respective regions. The database shall have different access rights for different users.

4. The changes in the network and protection settings of grid elements connected to 220kV and above (132 kV and above in NER) shall be informed to RPCs by CTU and STUs, as the case may be.
5. The elements of network below 66kV and radial in nature which do not impact the National Grid may be excluded as finalized by the respective RPC.

- **Protection audit plan**

1. All users shall conduct internal audit of their protection systems annually, and any shortcomings identified shall be rectified and informed to their respective RPC. The audit report along with action plan for rectification of deficiencies detected, if any, shall be shared with respective RPC for users connected at 220 kV and above (132 kV and above in NER).
2. All users shall also conduct third party protection audit of each sub-station at 220 kV and above (132 kV and above in NER) once in five years or earlier as advised by the respective RPC.
3. After analysis of any event, each RPC shall identify a list of substations / and generating stations where third-party protection audit is required to be carried out and accordingly advise the respective users to complete third party audit within three months.
4. The third-party protection audit report shall contain information sought in the format enclosed as Annexure–1. The protection audit reports, along with action plan for rectification of deficiencies detected, if any, shall be submitted to the respective RPC and RLDC or SLDC, as the case may be, within a month of submission of third-party audit report. The necessary compliance to such protection audit report shall be followed up regularly in the respective RPC.
5. Annual audit plan for the next financial year shall be submitted by the users to their respective RPC by 31<sup>st</sup> October. The users shall adhere to the annual audit plan and report compliance of the same to their respective RPC.
6. Users shall submit the following protection performance indices of previous month to their respective RPC and RLDC on monthly basis for 220 kV and above (132 kV and above in NER) system, which shall be reviewed by the RPC:
  - a. The Dependability Index defined as

$$D = \frac{Nc}{Nc+Nf}$$

Where,

$N_c$  is the number of correct operations at internal power system faults and

$N_f$  is the number of failures to operate at internal power system faults.

- b. The Security Index defined as

$$S = \frac{N_c}{N_c + N_u}$$

Where,

$N_c$  is the number of correct operations at internal power system faults

$N_u$  is the number of unwanted operations.

- c. The Reliability Index defined as

$$R = \frac{N_c}{N_c + N_i}$$

Where,

$N_c$  is the number of correct operations at internal power system faults

$N_i$  is the number of incorrect operations and is the sum of  $N_f$  and  $N_u$

7. Each user shall also submit the reasons for performance indices less than unity of individual element wise protection system to the respective RPC and action plan for corrective measures. The action plan will be followed up regularly in the respective RPC.
8. In case any user fails to comply with the protection protocol specified by the RPC or fails to undertake remedial action identified by the RPC within the specified timelines, the concerned RPC may approach the Commission with all relevant details for suitable directions.

- **System Protection Scheme (SPS)**

1. SPS for identified system shall have redundancies in measurement of input signals and communication paths involved up to the last mile to ensure security and dependability.
2. For the operational SPS, RLDC or NLDC, as the case may be, in consultation with the concerned RPC(s) shall perform regular load flow and dynamic studies and mock

testing for reviewing SPS parameters & functions, at least once in a year. RLDC or NLDC shall share the report of such studies and mock testing including any shortcomings to respective RPC(s). The data for such studies shall be provided by CTU to the concerned RPC, RLDC and NLDC.

3. The users and SLDCs shall report about the operation of SPS immediately and detailed report shall be submitted within three days of operation to the concerned RPC and RLDC in the format specified by the respective RPCs.
4. The performance of SPS shall be assessed as per the protection performance indices specified in these Regulations. In case, the SPS fails to operate, the concerned User shall take corrective actions and submit a detailed report on the corrective actions taken to the concerned RPC within a fortnight.

- **Recording instruments**

1. All users shall keep the recording instruments (disturbance recorder and event logger) in proper working condition.
2. The disturbance recorders shall have time synchronization and a standard format for recording analogue and digital signals which shall be included in the guidelines issued by the respective RPCs.
3. The time synchronization of the disturbance recorders shall be corroborated with the PMU data or SCADA event loggers by the respective RLDC. Disturbance recorders which are non-compliant shall be listed out for discussion at RPC.

## **Annexure – 5: Third Party Protection System Checking & Validation Template for a Substation (IEGC 2023 Annexure – 1)**

### **1. Introduction**

- a. The audit reports, along with action plan for rectification of deficiencies found, if any, shall be submitted to RPC or RLDC within a month of submission of report by auditor.
- b. The third-party protection system checking shall be carried at site by the designated agency. The agency shall furnish two reports:
  - i. Preliminary Report: This report shall be prepared on the site and shall be signed by all the parties present.
  - ii. Detailed Report: This report shall be furnished by agency within one month after carrying out detailed analysis.

### **2. Checklist**

- a. The protection system checklist shall contain information as per this Regulation.
  - i. General Information (to be provided prior to the checking as well as to be included in final report):
    - Substation name
    - Name of Owner Utility
    - Voltage Level (s) or highest voltage level?
    - Short circuit current rating of all equipment (for all voltage level) (v) Date of commissioning of the substation
    - Checking and validation date
    - Record of previous tripping's (in last one year) and details of protection operation
    - Previous Relay Test Reports
    - Overall single line diagram (SLD) (x) AC aux SLD
    - DC aux SLD
    - SAS architecture diagram
    - SPS scheme implemented (if any)
  - b. The preliminary report shall inter-alia contain the following:



**TABLE A: FORMAT OF PRELIMINARY REPORT**

<b>S. No.</b>	<b>Issues</b>	<b>Remarks</b>
1	Recommendation of last protection checking and validation	Status of works and pending issues if any
2	Review of existing settings at substation	Recommended Action
3	Disturbance Recorder out/ available for last 6 tripping's (Y/N)	Recommended Action
4	Chronic reason of tripping, if any	Recommended Action
5	Major non-conformity/deficiency observed	Recommended Action

c. The relay configuration checklist for available power system elements at station:

- Transmission Line
- Bus Reactor/Line Reactor
- Inter-connecting Transformer
- Busbar Protection Relay
- AC auxiliary system
- DC auxiliary system
- Communication system
- Circuit Breaker Details
- Current Transformer details
- Capacitive Voltage Transformers Details
- Any other equipment/system relevant for protection system operation

d. The minimum set of points on which checking and validation shall be carried out is covered in this clause. The detailed list shall be prepared by checking and validation team in consultation with concerned entity, RLDC and RPC.

**i. Transmission Line Distance Protection/Differential Protection**

- Name and Length of Line
- Whether series compensated or not
- Mode of communication used (PLCC/OPGW)
- Relay Make and Model for Main-I and Main-II

- List of all active protections & settings
- Carrier aided scheme if any
- Status of Power Swing/Out of Step/SOTF/Breaker Failure/Broken Conductor/STUB/Fault Locator/DR/VT fuse fail/Overvoltage Protection/Trip Circuit supervision/Auto-reclose/Load encroachment etc.
- Relay connected to Trip Coil-1 or 2 or both i. CT ratio and PT ratio
- Feed from DC supply-1 or 2
- Connected to dedicated CT core (mention name)
- Other requirements for protection checking and validation

#### **ii. Shunt Reactor & Inter-connecting Transformer Protection**

- Whether two groups of protections used (Group A and Group B)
- Do the groups have separate DC sources
- Relay Make and Model
- List of all active protections along with settings
- Status of Differential Protection/Restricted Earth Fault Protection/Back-up Directional Overcurrent/Backup Earth fault/ Breaker Failure
- Status of Oil Temperature Indicator/Winding Temperature Indicator/Bucholz/Pressure Release Device etc.
- Relay connected to Trip Coil-1 or 2 or both
- CT ratio and PT ratio
- Feed from DC supply-1 or 2
- Connected to dedicated CT core (mention name)
- Other requirements for protection checking and validation

#### **iii. Busbar Protection Relay**

- Busbar and redundant relay make and model
- Type of Busbar arrangement
- Zones
- Dedicated CT core for each busbar protection (Yes/No)
- Breaker Failure relay included (Yes/No), if additional then furnish make and model
- Trip issued to both Busbar protection in case of enabling
- Isolator indication and check relays
- Other requirements for protection checking and validation

#### **iv. AC auxiliary system**

- Source of AC auxiliary system
- Supply changeover between sources (Auto/Manual)
- Diesel generator (DG) details
- Maintenance plan and supply changeover periodicity in DG
- Single Line Diagram
- Other requirements for protection checking and validation

#### **v. DC auxiliary system**

- Type of Batteries (Make, vintage, model)
- Status of battery Charger
- Measured voltage (positive to earth and negative to earth)
- Availability of ground fault detectors
- Protection relays and trip circuits with independent DC sources
- Other requirements for protection checking and validation
- Communication system
  - Mode of communication for Main-1 and Main-2 protection
  - Mode of communication for data and speech communication
  - Status of PLCC channels
  - Time synchronization equipment details
  - 7OPGW on geographically diversified paths for Main-1 and main-2 relay
  - Other requirements for protection checking and validation

#### **vi. Circuit Breaker Details**

- Details and Status
- Healthiness of Tripping Coil and Trip circuit supervision relay
- Single Pole/Multi pole operation
- Pole Discrepancy Relay available (Y/N)
- Monitoring Devices for checking the dielectric medium
- Other requirements for protection checking and validation
- Current Transformer (CT)/Capacitive Voltage Transformer (CVT) Details
  - CT/CVT ID name and voltage level
  - CT/CVT core connection details
  - Accuracy Class
  - Whether Protection/Metering

- CT/CVT ratio available and ratio adopted
- Details of last checking and validation of CT/CVT healthiness
- Other requirements for protection checking and validation
- Other protections: Direction earth fault, negative sequence, over current, over voltage, over frequency, under voltage, under frequency, forward power, reverse power, out of step/power swing, HVDC protection etc.

### 3. Summary of checking:

The summary shall specifically mention minimum following points:

- a) The settings and scheme adopted are in line with agreed protection philosophy or any accepted guidelines (e.g. Ramakrishna guidelines or CBIP manual based).
- b) The deviations from the RPC protection philosophy, if any and reasons for taking the deviations shall be recorded.
- c) All the major general deficiency shall be listed in detail along with remedial recommendations.
- d) The relay settings to be adopted shall be validated with simulation based or EMTP studies and details shall be enclosed in report.
- e) The cases of protection maloperation shall be analysed from protection indices report furnished by concerned utility, the causes of failure along with corrective actions and recommendations based on the findings shall be noted in the report.

## Annexure – 6: Protection Philosophy/Protocol of Northern Region

The Protection Philosophy/Protocol of Northern Region is developed in compliance of IEGC 2023, Version 2.0 which was approved in 71<sup>st</sup> NRPC meeting held on 29.01.2024.

S.N.	Protection Setting/Protocol	Mandated Setting for transmission lines
1	<b>Protection Scheme</b>	<p>220kV and above: Independent Main-I and Main-II protection (of different make OR different type/different algorithm) of non-switched numerical type is to be provided with carrier aided scheme.</p> <p>132kV and below: One non-switched distance protection scheme and, directional over current and earth fault relays, should be provided as back up.</p>
2	<b>Distance Protection Zone-1</b>	<p>Reach: 80% of the protected line; 110% of the protected line (In case of radial lines) Time Setting: Instantaneous.</p>
3	<b>Distance Protection Zone-2</b>	<p>Reach: Single Circuit Line: 120% of length of principle line section. Double circuit line: 150% coverage of line to take care of under reaching due to mutual coupling effect.</p> <p>Time setting: i. 0.35 second (considering LBB time of 200mSec, CB open time of 60ms, resetting time of 30ms and safety margin of 60ms) ii. 0.5-0.6 second (For a long line followed by a short line)</p>
4	<b>Distance Protection Zone-3</b>	Reach: Zone-3 should overreach the remote

S.N.	Protection Setting/Protocol	Mandated Setting for transmission lines
		<p>terminal of the longest adjacent line by an acceptable margin (typically 20% of highest impedance seen) for all fault conditions.</p> <p>Time Setting: 800-1000 msec</p> <p>If zone-3 reach transcends to other voltage level, time may be taken up to 1.5 sec.</p>
5	<b>Distance Protection Zone- 4</b>	<p>The Zone-4 reverse reach must adequately cover expected levels of apparent bus bar fault resistance.</p> <p>Time may be coordinated accordingly.</p> <p>Where Bus Bar protection is not available, time setting: 160 msec.</p>
6	<b>Lines with Series and other compensations in the vicinity of Substation</b>	<ul style="list-style-type: none"> <li>• Zone-1: FSC end: 60% of the protected line. Time: Instantaneous; Remoted end: 60% of the protected line with 100ms-time delay. POR Communication scheme logic is modified such that relay trips instantaneously in Zone-1 on carrier receive.</li> <li>• Zone-2: 120 % of uncompensated line impedance for single circuit line. For Double circuit line, settings may be decided on basis of dynamic study in view of zero sequence mutual coupling.</li> <li>• Phase locked voltage memory is used to cope with the voltage inversion. Alternatively, an intentional time delay may be applied to overcome directionality problems related to voltage inversion.</li> <li>• over-voltage stage-I setting for series compensated double circuit lines may be kept higher at 113%.</li> </ul>

S.N.	Protection Setting/Protocol	Mandated Setting for transmission lines
7	<b>Power Swing Blocking</b>	Block tripping in all zones, all lines. Out of Step tripping to be applied on all inter-regional tie lines. Deblock time delay = 2s
8	<b>Protection for broken conductor</b>	Negative Sequence current to Positive Sequence current ratio more than 0.2 (i.e. $I_2/I_1 \geq 0.2$ ) Alarm Time delay: 3-20 sec. Tripping may be considered for radial lines to protect single phasing of transformers.
9	<b>Switch on to fault (SOTF)</b>	Switch on to fault (SOTF) function to be provided in distance relay to take care of line energization on fault.
10	<b>VT fuse fail detection function</b>	VT fuse fail detection function shall be correctly set to block the distance function operation on VT fuse failure.
11	<b>Carrier Protection</b>	To be applied on all 220kV and above lines with the only exception of radial feeders.
12	<b>Back up Protection</b>	1. On 220kV and above lines with 2 Main Protections: <ul style="list-style-type: none"> <li>• Back up Earth Fault protections alone to be provided.</li> <li>• No Over current protection to be applied.</li> </ul> 2. At 132kV and below lines with only one Main protection: <ul style="list-style-type: none"> <li>• Back up protection by IDMT O/C and E/F to be <b>applied</b>.</li> </ul>
13	<b>Auto Reclosing with dead time.</b>	AR shall be enabled for 220 kV and above lines for single pole trip and re-closing. Dead time = 1.0s. Reclaim time = 25.0s  Auto-recloser shall be blocked for following: <ul style="list-style-type: none"> <li>• faults in cables</li> </ul>

S.N.	Protection Setting/Protocol	Mandated Setting for transmission lines
		<ul style="list-style-type: none"> <li>• Breaker Fail Relay</li> <li>• Line Reactor Protections</li> <li>• O/V Protection</li> <li>• Received Direct Transfer trip signals</li> <li>• Busbar Protection</li> <li>• Zone 2/3 of Distance Protection</li> <li>• Circuit Breaker Problems.</li> </ul> <p>CB Pole discrepancy relay time:1.5 sec; for tie breaker: 2.5 sec</p>
14	<b>Busbar protection</b>	To be applied on all 220kV and above sub stations with the only exception of 220kV radial fed bus bars.
15	<b>Local Breaker Backup (LBB)</b>	<p>For 220 kV and above level substations as well as generating stations switchyards, LBB shall be provided for each circuit breaker.</p> <p>LBB Current sensor <math>I &gt; 20\%</math> In LBB time delay = 200ms</p> <p>In case of variation in CT ratio, setting may be done accordingly.</p>
16	<b>Line Differential</b>	<p>For cables and composite lines, line differential protection with built in distance back up shall be applied as Main-I protection and distance relay as Main-II protection.</p> <p>For very short line (less than 10 km), line differential protection with distance protection as backup (built- in Main relay or standalone) shall be provided mandatorily as Main-I and Main-II.</p> <p>Differential protection may be done using dark fiber (preferably), or using bandwidth.</p>



S.N.	Protection Setting/Protocol	Mandated Setting for transmission lines
17	<b>Over Voltage Protection</b>	<p>FOR 765kV LINES/CABLE:  Low set stage (Stage-I): 106% - 109% (typically 108%) with a time delay of 5 seconds.  High set stage (Stage-II): 140% - 150% with a time delay of 100 milliseconds.</p> <p>400kV LINES/CABLE:  Low set stage (Stage-I): 110% - 112% (typically 110%) with a time delay of 5 seconds.  High set stage (Stage-II): 140% - 150% with a time delay of 100 milliseconds.</p> <p>FOR 220 KV LINES:  No over-voltage protection shall be used.</p> <p>FOR 220 KV CABLE:  Low set stage (Stage-I): 110% - 112% (typically 110%) with a time delay of 5 seconds.  High set stage (Stage-II): 140% - 150% with a time delay of 100 milliseconds.</p> <p>Drop-off to pick-up ratio of overvoltage relay:  better than 97%</p> <p>Grading: Voltage as well as time grading may be done for multi circuit lines/cable.</p>
18	<b>Resistive reach setting to prevent load point encroachment</b>	<p>Following criteria may be considered for deciding load point encroachment:</p> <ul style="list-style-type: none"> <li>Maximum load current (Imax) may be considered as 1.5 times the thermal rating of the line or 1.5 times the associated bay equipment current</li> </ul>

S.N.	Protection Setting/Protocol	Mandated Setting for transmission lines
		<p>rating (the minimum of the bay equipment individual rating) whichever is lower. (Caution: The rating considered is approximately 15minutes rating of the transmission facility).</p> <ul style="list-style-type: none"> <li>• Minimum voltage (<math>V_{min}</math>) to be considered as 0.85pu (85%).</li> </ul>
19	Direct Inter-trip	<p>To be sent on operation of following:</p> <ol style="list-style-type: none"> <li>i. Overvoltage Protection</li> <li>ii. LBB Protection</li> <li>iii. Busbar Protection</li> <li>iv. Reactor Protection</li> <li>v. Manual Trip (400 kV and above)</li> </ol> <p>Cable Fault (in composite lines)</p>
20	Permissive Inter-trip	To be sent on operation of Distance Protection

## Annexure – 7: Work Order & Corrigendum



पावर ट्रांसमिशन कारपोरेशन ऑफ उत्तराखण्ड लि0  
(उत्तराखण्ड सरकार का उपक्रम)  
अधीक्षण अभियन्ता (परीक्षण एवं परिचालन एवं स्काडा) कार्यालय  
कुमायु मण्डल हल्द्वानी  
मोबाइल नं0 9412089275, ईमेल dp\_singh@ptcul.org

No. 376 /SE (T&C)/PTCUL/ (H)/

Date:29.09.2023

Subject:- Order for Protection Audit of 02 Nos 400 kV and 08 Nos 220KV sub-stations in PTCUL.

Joint Advisor

Central Board of Irrigation and Power

Malcha Marg Chanakyapuri,

New Delhi-110021

Email: mrchauhan@cbip.org.

Dear Sir,

In reference to your offer submitted vide Ref No: P-1/CBIP/PTCUL/PTCUL/Audit/2023 dated: 11.09.2023 through email against Email enquiry dated 05.09.2023, an order is hereby placed in favour of your firm for the work of "Protection Audit of 02 Nos 400kV and 08 Nos 220 kV substations of PTCUL" The detail of material, price schedule and terms & conditions is here as under:-

Sr.No	Description	Unit	Qty	Amount	Total Amount
1	Protection Audit to be carried out for the following 10 nos of the 400/220kV substations of PTCUL :- 1. 400kV S/s Rishikesh 2. 400 kV S/s Kashipur 3. 220kV S/s Chamba 4. 220kV S/s Rishikesh 5. 220kV S/s Roorkee 6. 220kV S/s Haridwar (SIDCUL) 7. 220kV S/s Jhajra. 8. 220 kV S/s Pantnagar. 9. 220 kV S/s Haldwani. 10. 220kV S/s Mahuakheraganj.	Job	1	36,25,000	36,25,000
	TOTAL				36,25,000

Total value of order is Rs.36,25,000 (Rupees Thirty Six Lakh Twenty Five Thousand only ) Plus GST Extra.

End: 1. Terms & Conditions.

Please acknowledge the receipt and acceptance of order.

(D.P Singh)

Superintending Engineer (T&C), Haldwani

No.376 /SE (T&C)/PTCUL/ (H)/

Date:29.09.2023

Copy forwarded to the following for information and necessary action:-

1. Director (Operation), PTCUL, Dehradun.
2. Superintending Engineer (A) MD, PTCUL, Dehradun.
3. Chief Engineer, T&C PTCUL, 132kV Substation Campus, Kathgodam Nainital.
4. Executive Engineer, T&C Division, Kashipur.
5. Director (Energy), Central Board of Irrigation and Power Malcha Marg Chanakyapuri, New Delhi-110021 Email: [sanjeev@cbip.org](mailto:sanjeev@cbip.org)

(D.P Singh)

Superintending Engineer (T&C), Haldwani

मुख्यालय एवंपंजीकृत कार्यालय:-विद्युतमवन, नजदीक-आई0एस0बी0टी0 क्रासिंग, सहारनपुररोड, माजरा, देहरादून-248002  
कारपोरेटआईडी नं0: U40101UR2004GOI028675 दूरभाष नं0 0135-2646000 फॅक्स नं0 0135-2643460 वेबसाइट [www.ptcul.org](http://www.ptcul.org)



पावर ट्रांसमिशन कारपोरेशन ऑफ उत्तराखण्ड लि0  
(उत्तराखण्ड सरकार का उपक्रम)  
अधीक्षण अभियन्ता (परीक्षण एवं परिचालन एवं स्काडा) कार्यालय  
कुमायु मण्डल हल्द्वानी  
मोबाइल नं0 9412089275, ईमेल dp\_singh@ptcul.org

**Terms & Conditions:-**

<b>1</b>	<b>Scope</b>	<p>: The detailed Scope work is as under:</p> <ol style="list-style-type: none"><li>1. There must be a kick off meeting for discussion on project plan before start of the work in field and the detailed plan of performance shall be submitted by CBIP.</li><li>2. Requisite data shall be collected in standard format from PTCUL grid substations by authorized and experienced auditor.</li><li>3. The site surveys and audit of grid substations of PTCUL shall be done by authorized and experienced auditor.</li><li>4. Review of the implemented protection schemes/philosophy for 400/220 kV substations which includes protection of transmission lines,interconnecting transformers, line/busreactors, bus bar, bus couplers etc.as per latest guidelines of Ramakrishna committee/CBIP/NRPC/Intenational best practices.etc.</li><li>5. Review the adequacy of primary and backup protection settings for protected equipment and suggest corrective measures where evernon compliance with respect to Ramakrishna committee/ CBIP/NRPC is found during the protection audit.</li><li>6. Review of availability/healthiness of PLCC communication links used for protection systems.</li><li>7. Review the healthiness/adequacy of 220/110/50V DC system available at substations for protection application.</li><li>8. Review of availability/healthiness of GPS system and time synchronization facility used for protection.</li><li>9. Review of availability/healthiness of recording instruments like DRs /ELs for transmission lines protection.</li><li>10. Review of test reports for assessing the healthiness of circuit breakers, CT &amp; CVT based upon available test reports at sites.</li><li>11. Field inspection of protection device for obsolescence of technology, suitability and healthiness.</li><li>12. Directory of the protection system &amp; recommendation for replacement of obsolescence relays with compatible numerical relays will be provided.</li><li>13. Checking of availability of DGset/auxiliary DC supply at substations.</li><li>14. Site visits for onsite protection audit, review and inspection of substations will be performed.</li><li>15. Submission of the detailed report for the protection audit including the protection philosophy, reviewed settings and protection audit observations.</li><li>16. The performance of above protection equipment like relays, circuit breaker, CT, CVT, DC battery bank, synchro facility, communication facility used for protection will be also checked through physical inspection and provided test reports/documents. These protection equipments will be recommended for renovation and upgradation based on their performance accessed during protection audit and physical inspection.</li><li>17. Review the availability healthiness of<ul style="list-style-type: none"><li>• Event recorders/ loggers' operation history</li><li>• CT, CVT, CB</li><li>• DC power supply</li><li>• Auxiliary supply</li><li>• Communication links</li><li>• Time synchronization/ GPS</li></ul></li><li>18. Review of Testing and Maintenance records of all protective relays, Circuit Breakers CT, CVT etc. Review of protection philosophy.</li></ol>
----------	--------------	--

मुख्यालय एवंपजीकृत कार्यालय:-विद्युतमवन, नजदीक-आई0एस0बी0टी0 क्रासिंग, सहारनपुररोड, माजरा, देहरादून-248002  
कारपोरेटआईडी नं0: U40101UR2004G01028675 दर्माश नं0 0135-2646000 फ़ैक्स नं0 0135-2643460 वेबसाइटwww.ptcul.org





पावर ट्रांसमिशन कारपोरेशन ऑफ उत्तराखण्ड लि०  
(उत्तराखण्ड सरकार का उपक्रम)  
अधीक्षण अभियन्ता (परीक्षण एवं परिचालन एवं स्काडा) कार्यालय  
कुमायु मण्डल हल्द्वानी  
मोबाइल नं० 9412089275, ईमेल dp\_singh@ptcul.org

			19. Anything which is left to be mentioned here but required for successful completion of the aforementioned subject work shall be done <b>Central Board of Irrigation and Power Malcha Marg Chanakyapuri, New Delhi-110021</b> 20. CBIP Delhi shall submit a report on detailed points in four sets of hard copy duly spiraled binding as well as soft copy shall be submitted. 21. The safety guidelines prevalent in PTCUL must be followed.
2	GST	:	GST shall be paid extra as per applicable Government rules.
3	Tax	:	Tax shall be deducted at source as per applicable Government rules. A certificate to this effect may be given to the Contractor if required.
4	Date of Start of work	:	Order shall be considered as having come in to force from the date of issue of order.
5	Supply Completion	:	NA
6	Work completion	:	The work should be completed within 24 months from the date of issue of order.
7	Engineer of the contract		Superintending Engineer (T&C), Haldwani is the "Engineer of the contract" who shall be placing the order for the work with the contractor and signing the contract agreement and who has been inherently vested with such powers by corporation in this behalf and shall act as Engineer for the purpose of the contract.
8	Engineer in-charge		Respective Executive Engineer (T&C) shall be "Engineer in charge" for the subject work.
9	Liquidity damages	:	If the contract is delayed beyond the stipulated period mentioned in the contract. The liquidity damages shall be levied @ 0.5 % per week and maximum up to 10% of contract value.
10	Dispute		All Dispute arising out of this case under the jurisdiction local court at Kashipur and Honable High Court, Nainital.
11	Payment terms	:	1. 25% Payment will be made within 30 days after finalization of Audit plan, subject to availability of funds from PTCUL HQ. 2. 35% Payment will be made within 30 days after submission of preliminary reports verified by Executive Engineer of respective division, subject to availability of funds from PTCUL HQ. 3. 40 % Payment will be made within 30 days after submission of final reports verified by Executive Engineer of respective division, subject to availability of funds from PTCUL HQ.
12	Payment unit		Test & Commissioning Division, Kashipur shall be the payment unit and all units where is to be work done shall record the measurement and duly passed bills along with measurement book shall be submitted to payment unit.
13	Warranty period	:	NA.
14	Billing Address	:	Executive Engineer Test & Commissioning Division, PTCUL 400 KV Substation Campus, Kashipur (Uttarakhand)-244713, GSTIN No. (05AAECM1785FC29)

All other term and condition of this order shall be governed by the General conditions of the contract prevalent in PTCUL.

(D.P Singh)

Superintending Engineer(T&C), Haldwani

मुख्यालय एवंपंजीकृत कार्यालय:-विद्युतमवन, नजदीक-आई०एस०बी०टी० क्रासिंग, सहारनपुररोड, गाजरा, देहरादून-248002  
कारपोरेटआईडी नं०: U40101UR2004GOI028675 दरमारा नं० 0135-2646000 फ़ैक्स नं० 0135-2643460 वेबसाइटwww.ptcul.org



पावर ट्रांसमिशन कारपोरेशन ऑफ उत्तराखण्ड लि०  
(उत्तराखण्ड सरकार का उपक्रम)  
अधीक्षण अभियन्ता (परीक्षण एवं परिचालन एवं स्काडा) कार्यालय  
कुमायु मण्डल हल्द्वानी  
मोबाइल नं० 9412089275, ईमेल dp\_singh@ptcul.org

No. 394 /SE (T&C)/PTCUL/ (H)/

Date:26.10.2023

Subject:- Corrigendum for the Order for the work of Protection Audit of 02 Nos 400 kV and 08 Nos 220KV sub-stations in

PTCUL

Joint Advisor

Central Board of Irrigation and Power

Malcha Marg Chanakyapuri,

New Delhi-110021

Email: mrchauhan@cbip.org.

Dear Sir,

In reference to above mentioned subject, please refer to kick off meeting held on dated 26.10.2023 for the work of Protection Audit of 02 Nos 400 kV and 08 Nos 220KV sub-stations in PTCUL against order no.376 dated 29.09.2023.

In this regard, kindly find enclosed herewith corrigendum of order no.376 dated 29.09.2023 (Annexure-1) with necessary amendments as discussed in afforementioned meeting.

This is for your kind information and necessary action.

Please acknowledge the receipt and acceptance of order.

(D.P Singh)

Superintending Engineer (T&C), Haldwani

Copy forwarded to the following for information and necessary action:-

1. Chief Engineer, T&C PTCUL, 132kV Substation Campus, Kathgodam Nainital..
2. Executive Engineer, T&C Division, Roorkee/Dehradun/Haldwani/Kashipur/Rishikesh with request to provide assistance and information to CBIP for the above work.
3. Director (Energy), Central Board of Irrigation and Power Malcha Marg Chanakyapuri, New Delhi-110021  
Email: [sanjeev@cbip.org](mailto:sanjeev@cbip.org)

मुख्यालय एवंपंजीकृत कार्यालय:-विद्युतमवन, नजदीक-आई०एस०बी०टी० क्रॉसिंग, सहारनपुररोड, माजरा, देहरादून-248002  
कारपोरेटआईडी नं०: U40101UR2004GOI028675 दूरभाष नं० 0135-2646000 फॅक्स नं० 0135-2643460 वेबसाइट [www.ptcul.org](http://www.ptcul.org)

Annexure -1 – Work order corrigendum

Scope: The detailed Scope work is as under:

S. No.	Clause of PO	Existing Clause					Modified Clause						
		Sr. No	Description	Unit	Qty	Amount	Total Amount	Sr. No	Description	Unit	Qty	Unit rate (Rs.)	Total Amount (Rs.)
1	Price Schedule	1	Protection Audit to be carried out for the following 10 nos. of the 400/220kV substations of PTCUL - 1. 400kV S/s Rishikesh 2. 400 KV S/s Kashipur 3. 220kV S/s Chamba 4. 220kV S/s Rishikesh 5. 220kV S/s Roorkee 6. 220kV S/s Haridwar (SIDCUL) 7. 220kV S/s Jhajra 8. 220 KV S/s Pantnagar 9. 220 KV S/s Haldwani 10. 220kV S/s Mahaukheraganj. TOTAL	Job	1	36,25,000	36,25,000	1	Protection Audit to be carried out for the following 10 nos of the 400/220kV substations of PTCUL - 1. 400kV S/s Rishikesh 2. 400 KV S/s Kashipur 3. 220kV S/s Chamba 4. 220kV S/s Rishikesh 5. 220kV S/s Roorkee 6. 220kV S/s Haridwar (SIDCUL) 7. 220kV S/s Jhajra 8. 220 KV S/s Pantnagar 9. 220 KV S/s Haldwani 10. 220kV S/s Mahaukheraganj) TOTAL	Each	10	3,62,500	36,25,000
2	Terms and Conditions S. No. 1 – Scope	<p>1. There must be a kick off meeting for discussion on project plan before start of the work in field and the detailed plan of performance shall be submitted by CBIP.</p> <p>2. Requisite data shall be collected in standard format from PTCUL grid substations by authorized and experienced auditor.</p> <p>3. The site surveys and audit of grid substations of PTCUL shall be done by authorized and experienced auditor.</p> <p>4. Review of the implemented protection schemes/ philosophy for 400/220 kV substations which includes protection of transmission lines, interconnecting lines, interconnecting transformers, line/bus reactors, bus bar, bus couplers etc with respect to</p>					<p>1. There must be a kick off meeting for discussion on project plan before start of the work in field and the detailed plan of performance shall be submitted by CBIP.</p> <p>2. Requisite data shall be collected in standard format from PTCUL grid substations by an experienced auditor.</p> <p>3. The site surveys and audit of grid substations of PTCUL shall be done by an experienced auditor.</p> <p>4. Review of the implemented protection schemes/philosophy for 400/220 kV substations which includes protection of transmission lines, interconnecting transformers, bus bar, bus couplers etc with respect to</p>						





S. No.	Clause of PO	Existing Clause	Modified Clause
		couplers etc.as per latest guidelines of Ramakrishna committee/CBIP/NRPC/international best practices, etc.	tripping in last one year as per latest guidelines of Ramakrishna committee/CBIP/NRPC/international best practices, which includes review of the following:
5.	Review the adequacy of primary and backup protection settings for protected equipment and suggest corrective measures where everyone compliance with respect to Ramakrishna committee/ CBIP/NRPC is found during the protection audit.	Review the healthiness/adequacy of 220/110/50V DC system available at substations for protection application.	a) Adequacy of primary and backup protection settings for protected equipment and suggest corrective measures b) Availability/healthiness of PLCC communication links used for protection systems.
6.	Review of availability/healthiness of PLCC communication links used for protection systems.	Review the healthiness/adequacy of 220/110/50V DC system available at substations for protection application.	c) Healthiness/adequacy of 220/110/50V DC system available at substations for protection application.
7.	Review of availability/healthiness of GPS system and time synchronization facility used for protection.	Review of availability/healthiness of recording instruments like DRs /ELs for transmission lines protection.	d) Availability/healthiness of GPS system and time synchronization facility used for protection.
8.	Review of availability/healthiness of recording instruments like DRs /ELs for transmission lines protection.	Review of test reports for assessing the healthiness of circuit breakers, CT & CVT based upon available test reports at sites.	e) Availability/healthiness of recording instruments like DRs /ELs for transmission lines protection.
9.	Review of test reports for assessing the healthiness of circuit breakers, CT & CVT based upon available test reports at sites.	Field inspection of protection device for obsolescence of technology, suitability and healthiness.	f) Test reports for assessing the healthiness of circuit breakers, CT & CVT based upon available test reports at sites.
10.	Field inspection of protection device for obsolescence of technology, suitability and healthiness.	Directory of the protection system & recommendation for replacement of obsolescence relays with compatible numerical relays will be provided.	g) Field inspection of protection device for obsolescence of technology, suitability and healthiness.
11.	Directory of the protection system & recommendation for replacement of obsolescence relays with compatible numerical relays will be provided.	Checking of availability of DG Set/auxiliary DC supply at substations.	h) Prepare recommendation for replacement of obsolescence relays with compatible numerical relays will be provided.
12.	Checking of availability of DG Set/auxiliary DC supply at substations.	Site visits for onsite protection audit, review and inspection of substations will be performed.	i) Checking of availability of DG Set / auxiliary DC supply at substations.
13.	Site visits for onsite protection audit, review and inspection of substations will be performed.	Submission of the detailed report for the protection audit including the protection philosophy, reviewed settings and protection audit observations.	5. Site visits for onsite protection audit, review and inspection of substations will be performed
14.	Submission of the detailed report for the protection audit including the protection philosophy, reviewed settings and protection audit observations.	The performance of above protection equipment like relays, circuit breaker, CT, CVT, DC battery bank, synchro facility, communication facility used for protection will be also checked through physical inspection and provided test reports/documents. These protection equipment's will be recommended for renovation and upgradation based on their performance accessed during protection audit and physical inspection.	6. Submission of the detailed report for the protection audit including the protection philosophy, reviewed settings and protection audit observations.
15.	The performance of above protection equipment like relays, circuit breaker, CT, CVT, DC battery bank, synchro facility, communication facility used for protection will be also checked through physical inspection and provided test reports/documents. These protection equipment's will be recommended for renovation and upgradation based on their performance accessed during protection audit and physical inspection.		Deleted as it is covered in point 4 above.









S. No.	Clause of PO	Existing Clause	Modified Clause
		<p>17. Review the availability healthiness of</p> <ul style="list-style-type: none"> <li>• Event recorders/ loggers' operation history</li> <li>• CT, CVT, CB</li> <li>• DC power supply</li> <li>• Auxiliary supply</li> <li>• Communication links</li> <li>• Time synchronization/ GPS</li> </ul> <p>18. Review of Testing and Maintenance records of all protective relays, Circuit Breakers, CT, CVT etc. Review of protection philosophy.</p> <p>19. Anything which is left to be mentioned here but required for successful completion of the aforementioned subject work shall be done Central Board of Irrigation and Power Malcha Marg Chanakyapuri, New Delhi-110021</p> <p>20. CBIP Delhi shall submit a report on detailed points in four sets of hard copy duly spiraled binding as well as soft copy shall be submitted.</p> <p>21. The safety guidelines prevalent in PTCUL must be followed.</p>	<p>7. Anything which is left to be mentioned here but required for successful completion of the aforementioned subject work shall be done by Central Board of Irrigation and Power.</p> <p>8. CBIP Delhi shall submit a protection report on detailed points in four sets of hard copy duly spiraled binding and in soft copy as well.</p> <p>9. The safety guidelines prevalent in PTCUL must be followed.</p>
3	Terms and Conditions – S. No. 6 - Work Completion	<p>The work should be completed within 24 months from the date of issue of order</p>	<p>The work should be completed within 24 weeks from the date of issue of corrigendum.</p>
4	Terms and Conditions – S. No. 8 - Engineer-in-charge	<p>Respective Executive Engineer (T&amp;C) shall be "Engineer in charge" for the subject work.</p>	<p>The following Executive Engineers (T&amp;C) shall be "Engineer in charge" for the subject work:</p> <p>a) 400KV Rishikesh, 220KV Rishikesh, 220 KV Chamba – Mr. Harsh Verma (Ph. No.9412074038 &amp; Email: ee_tandc_sh@ptcul.org).</p> <p>b) 400KV Kashipur, 220KV Pantnagar, 220KV Haldwani &amp; 220KV Mahuakheraganj – Mr. Asim Baig (Ph. No. 9412087885 &amp; Email: ee_tandc_asp@ptcul.org).</p> <p>c) 220KV SIDCUL Haridwar, 220 kv Roorkee – Mr. Ashwini Kumar (Ph. No.7088117301 &amp; Email: ee_tandc_ake@ptcul.org).</p> <p>d) 220KV Jhajra – Mr. Ravindra Kumar (Ph. No. 9927744222 &amp; Email: ee_tandc_ddun@ptcul.org).</p>



S. No.	Clause of PO	Existing Clause	Modified Clause
5	Terms and Conditions - S. No. 11 - Payment Terms	<ol style="list-style-type: none"> <li>1. 25% Payment will be made within 30 days after finalization of Audit plan, subject to availability of funds from PTCUL HQ.</li> <li>2. 35% Payment will be made within 30 days after submission of preliminary reports verified by Executive Engineer of respective division, subject to availability of funds from PTCUL HQ.</li> <li>3. 40 % Payment will be made within 30 days after submission of final reports verified by Executive Engineer of respective division, subject to availability of funds from PTCUL HQ.</li> </ol>	<ol style="list-style-type: none"> <li>1. 25% Payment will be made within 30 days after finalization of Audit plan, subject to availability of funds from PTCUL HQ.</li> <li>2. 35% Payment will be made within 30 days after submission of preliminary reports <b>on prorata basis</b> verified by Executive Engineer of respective division, subject to availability of funds from PTCUL HQ.</li> <li>3. 40 % Payment will be made within 30 days after submission of final reports <b>on prorata basis</b> verified by Executive Engineer of respective division, subject to availability of funds from PTCUL HQ.</li> <li>4. The local travel, lodging &amp; boarding shall be arranged by PTCUL on free-of-cost basis for CBIP team visiting the substation</li> </ol>







## **Annexure – 8: Data Sheets**

## Contents

<b>Single Line Diagrams</b> .....	52
<i>Substation Single Line Diagram</i> .....	52
<i>AC Auxiliary System</i> .....	53
<i>DC Auxiliary System</i> .....	54
<b>Bus-Bar Protection</b> .....	55
<b>AC Auxiliary System</b> .....	57
<b>DC Auxiliary System</b> .....	58
<b>Circuit Breakers</b> .....	59
<b>Current Transformer</b> .....	60
<b>Disturbance Recorder (DR) &amp; Event Logger (EL)</b> .....	63
<b>Communication System</b> .....	64
<b>Network Diagram of Uttarakhand</b> .....	65
<b>Power Map of Uttarakhand</b> .....	66

# Protection Audit of 220/132/33kV Mahuakheraganj Substation

## Annexure - 8

### Data Sheets

## Single Line Diagrams

### Substation Single Line Diagram

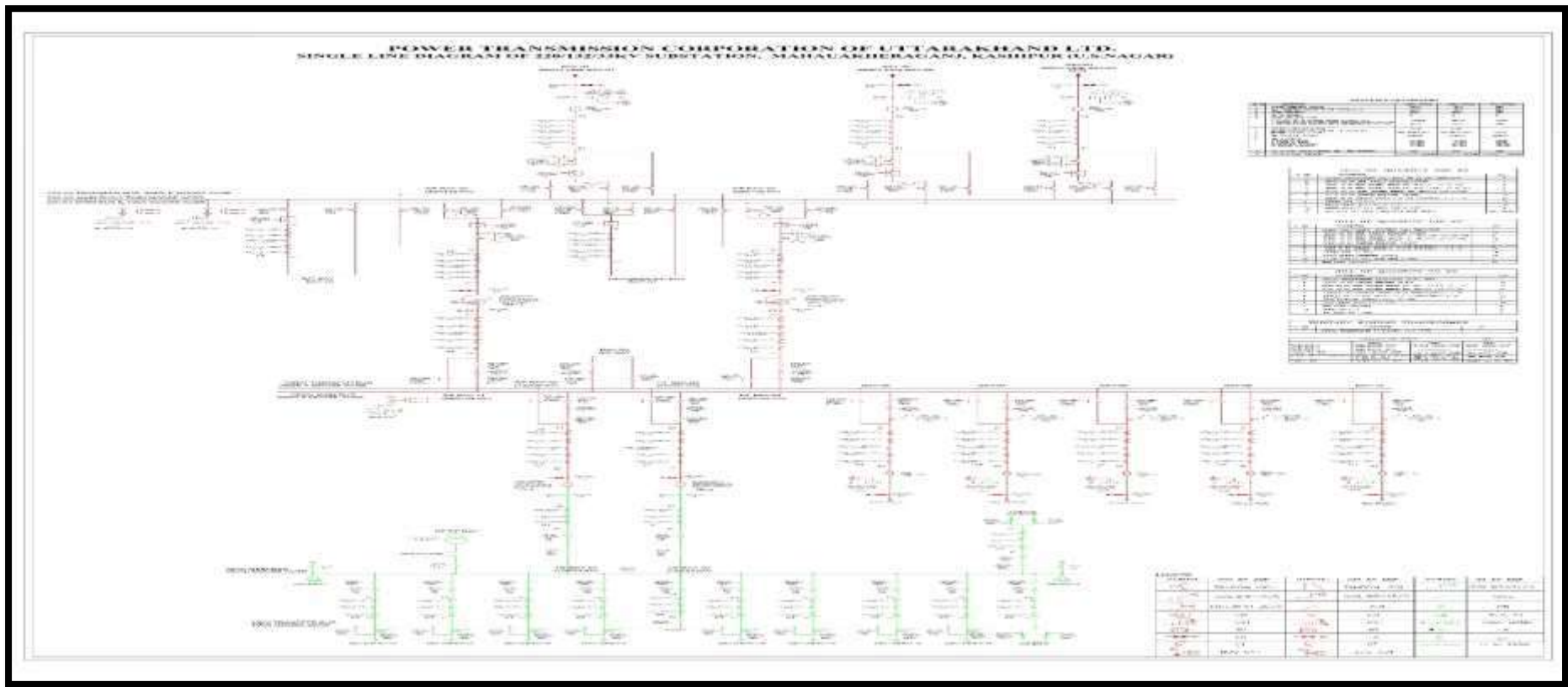

AC Auxiliary System

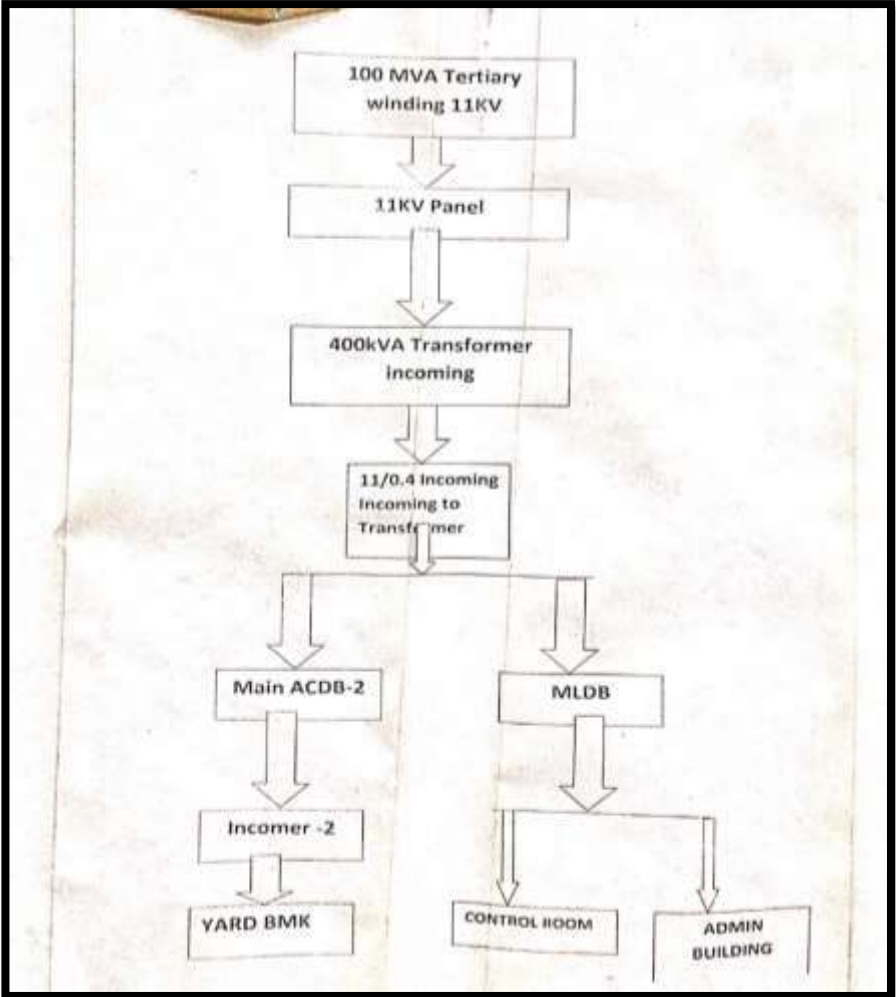
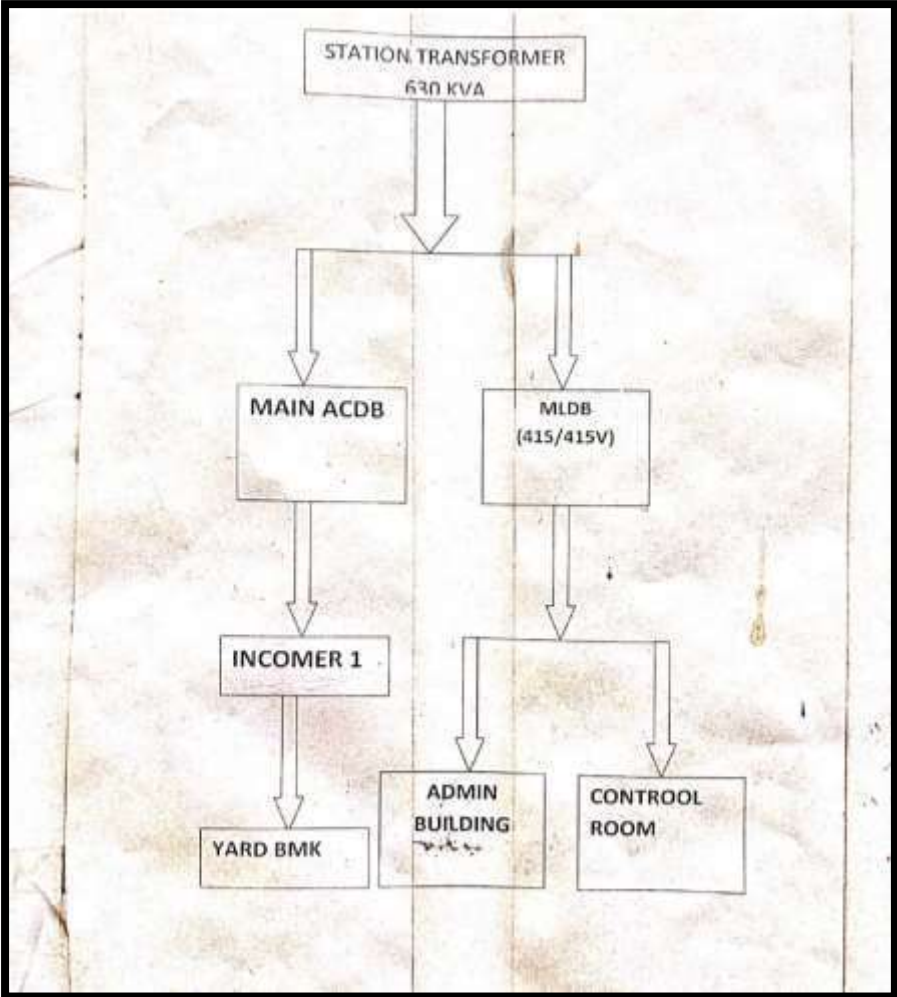

*DC Auxiliary System*

**Not Available**

## Bus-Bar Protection

### 220KV System:

Sl. No.	Particulars	Observations
a	Busbar and redundant relay make and model	GE B90
b	Type of Busbar arrangement	2 main and transfer
c	Zones	Three (Bus-1, Bus-2 and Check)
d	Dedicated CT core for each busbar protection	Yes
e	Breaker Failure relay included, if additional then furnish make and model	In case of any BFR operating in sub-station, the relevant zone will be tripped.
f	Trip issued to both Busbar protection in case of enabling	Not applicable
g	Isolator indication and check relays	This is part of Bay Unit
h	Other requirements for protection checking and validation	The Bus-bar protection relay was replaced, but is not compatible with Bay Units. Therefore, bus bar protection system is out of service. Utility has informed that zone IV of all distance protection is set in reverse direction and 160 ms (less than zone 2 time), in the absence of bus-bar protection.



**132KV System:**

<b>Sl. No.</b>	<b>Particulars</b>	<b>Observations</b>
<b>a</b>	<b>Busbar and redundant relay make and model</b>	NA
<b>b</b>	<b>Type of Busbar arrangement</b>	1 main and transfer
<b>c</b>	<b>Zones</b>	(Bus-1 and Check)
<b>d</b>	<b>Dedicated CT core for each busbar protection</b>	Yes
<b>e</b>	<b>Breaker Failure relay included, if additional then furnish make and model</b>	In case of any BFR operating in sub-station, the relevant zone will be tripped.
<b>f</b>	<b>Trip issued to both Busbar protection in case of enabling</b>	Not applicable
<b>g</b>	<b>Isolator indication and check relays</b>	This is part of Bay Unit
<b>h</b>	<b>Other requirements for protection checking and validation</b>	The Bus-bar protection relay was replaced, but is not compatible with Bay Units. Therefore, bus bar protection system is out of service. Utility has informed that zone IV of all distance protection is set in reverse direction and 160 ms (less than zone 2 time), in the absence of bus-bar protection.

## AC Auxiliary System

Sl. No.	Particulars	Observations
a	Source of AC auxiliary system	1 nos. 630KVA Station Transformers connected with 33kV Busbar.
b	Supply changeover between sources (Auto/Manual)	NA
c	Diesel generator (DG) details	Make: ZECKSON CUMMINS Rating: 250KVA
d	Maintenance plan and supply changeover periodicity in DG	a. The DG set operation is automatic, however, load manually connected, as DG is not capable of catering full emergency loads. b. As the auxiliary supply is quite reliable, DG operation is almost negligible. For testing purpose DG is operated once a week.
e	Single Line Diagram	Attached
f	Other requirements for protection checking and validation	NA

## DC Auxiliary System

Sl. No.	Particulars	Observations			
		220 V DC - I	220 V DC - II	48 V DC-I	48 V DC-II
<b>a</b>	<b>Make</b>	NA	NA	NA	NA
<b>b</b>	<b>Model/Rating</b>	500Ah	510Ah	300Ah	300Ah
<b>c</b>	<b>Vintage</b>	NA	NA	NA	NA
<b>d</b>	<b>Measured voltage</b>				
<b>i</b>	<b>Positive to Earth</b>	0V	118V	1.03V	1.46V
<b>ii</b>	<b>Negative to Earth</b>	240V	124V	49.2V	51.6V
<b>e</b>	<b>No. of Cells Per Bank</b>	NA	NA	NA	NA
<b>f</b>	<b>Availability of Battery Charger</b>	Yes	Yes	Yes	Yes

## Circuit Breakers

Sl. No.	Particulars	Make and Model	No. of trip/close coil	Trip Coil Supervision relay and healthiness of coils	LBB Setting Stage 1	LBB Setting Stage 2	Remarks (If any)
<b>A</b>	<b>220KV System</b>						
<b>1</b>	220KV Kashipur, SEPL, GIPL line, 100MVA T/F I&II(HV&LV)	MAKE-AREVA	2/1	HEALTHY	ENABLE	DISABLE	NA
<b>B</b>	<b>132KV system</b>						
<b>1</b>	132KV Kashipur, Thakurdwara Line, 80MVA T/F(I&II) HV&LV	MAKE-AREVA	2/1	HEALTHY	ENABLE	DISABLE	NA

## Current Transformer

<b>a</b>	<b>Location of CT</b>	<b>220KV, 400KV S/S KASHIPUR LINE</b>				
<b>b</b>	Date of CT ratio Test Testing					
		<b>Core I</b>	<b>Core II</b>	<b>Core III</b>	<b>Core IV</b>	<b>Core V</b>
<b>c</b>	Accuracy Class	PS	PS	0.2	BCU	PS
<b>d</b>	Purpose	21 M1 PROTECTION	21 M2 PROTECTION	METERING	BCU	BUSBAR PROTECTION
<b>e</b>	Test Results					
<b>i</b>	Ratio Adopted	800	800	800	800	800
<b>ii</b>	Ratio measured	NA	NA	NA	NA	NA

<b>a</b>	<b>Location of CT</b>	<b>220KV SEPL LINE</b>				
<b>b</b>	Date of CT ratio Test Testing					
		<b>Core I</b>	<b>Core II</b>	<b>Core III</b>	<b>Core IV</b>	<b>Core V</b>
<b>c</b>	Accuracy Class	PS	PS	0.2	BCU	PS
<b>d</b>	Purpose	21 M1 PROTECTION	21 M2 PROTECTION	METERING	BCU	BUSBAR PROTECTION
<b>e</b>	Test Results					
<b>i</b>	Ratio Adopted	800	800	800	800	800
<b>ii</b>	Ratio measured	NA	NA	NA	NA	NA

<b>a</b>	<b>Location of CT</b>	<b>220KV GIPL LINE</b>				
<b>b</b>	Date of CT ratio Test Testing					
		Core I	Core II	Core III	Core IV	Core V
<b>c</b>	Accuracy Class	PS	PS	0.2	BCU	PS
<b>d</b>	Purpose	21 M1 PROTECTION	21 M2 PROTECTION	METERING	BCU	BUSBAR PROTECTION
<b>e</b>	Test Results					
<b>i</b>	Ratio Adopted	800	800	800	800	800
<b>ii</b>	Ratio measured	NA	NA	NA	NA	NA

<b>a</b>	<b>Location of CT</b>	<b>132KV KASHIPUR LINE</b>				
<b>b</b>	Date of CT ratio Test Testing					
		Core I	Core II	Core III	Core IV	Core V
<b>c</b>	Accuracy Class	PS	PS	0.2	BCU	-
<b>d</b>	Purpose	DISTANCE PROTECTION	O/C PROTECTION	METERING	BCU	SPARE
<b>e</b>	Test Results					
<b>i</b>	Ratio Adopted	400	400	400	400	400
<b>ii</b>	Ratio measured	NA	NA	NA	NA	NA

<b>a</b>	<b>Location of CT</b>	<b>132KV THAKURDWARA LINE</b>				
<b>b</b>	Date of CT ratio Test Testing					
		Core I	Core II	Core III	Core IV	Core V
<b>c</b>	Accuracy Class	PS	PS	0.2	BCU	-
<b>d</b>	Purpose	DISTANCE PROTECTION	O/C PROTECTION	METERING	BCU	SPARE
<b>e</b>	Test Results					
<b>i</b>	Ratio Adopted	400	400	400	400	400
<b>ii</b>	Ratio measured	NA	NA	NA	NA	NA

## Disturbance Recorder (DR) & Event Logger (EL)

Sl. No.	Particulars	220kV	132Kv
1	a) Is the Disturbance recorder and Fault locator provided on all line feeders?	Yes	Yes
	b) Whether standalone or built in Main relay	Built-In	Built-In
	c) Whether DR is having automatic fault record download facility to a central PC	No	No
	d) Whether Central PC for DR, EL are powered by Inverter (fed from station DC)	NA	NA
2	Whether substation is having Event logger facility	Yes	Yes
	If Yes (standalone or built-in-SAS)	Built-In	Built-In
3	Whether GPS based time synchronizing equipment is provided at the substation for time synchronizing of Main relays / DR/ Event logger / SAS/ PMU / Line Current Differential Relays	Yes 2 Nos. (one for SAS & one for Relays/Equipment)	



## Communication System

Sl. No.	Name of Line Feeder	PLCC/OPGW /none	If PLCC for protection (y/n)	Coupling type & no. Of channel	If OPGW for protection (y/n)	Geographically distributed for main-1 & main-2 dedicated/multiplexed
1	220KV, 400KV S/S KASHIPUR LINE	PLCC	YES	NA	NO	Dedicated, Dedicated
2	220KV SEPL LINE	PLCC	YES	NA	NO	Dedicated, Dedicated
3	220KV GIPL LINE	PLCC	YES	NA	NO	Dedicated, Dedicated
4	132KV KASHIPUR LINE	PLCC	YES	NA	NO	Dedicated, Dedicated
5	132KV THAKURDWARA LINE	PLCC	YES	NA	NO	Dedicated, Dedicated

# Network Diagram of Uttarakhand

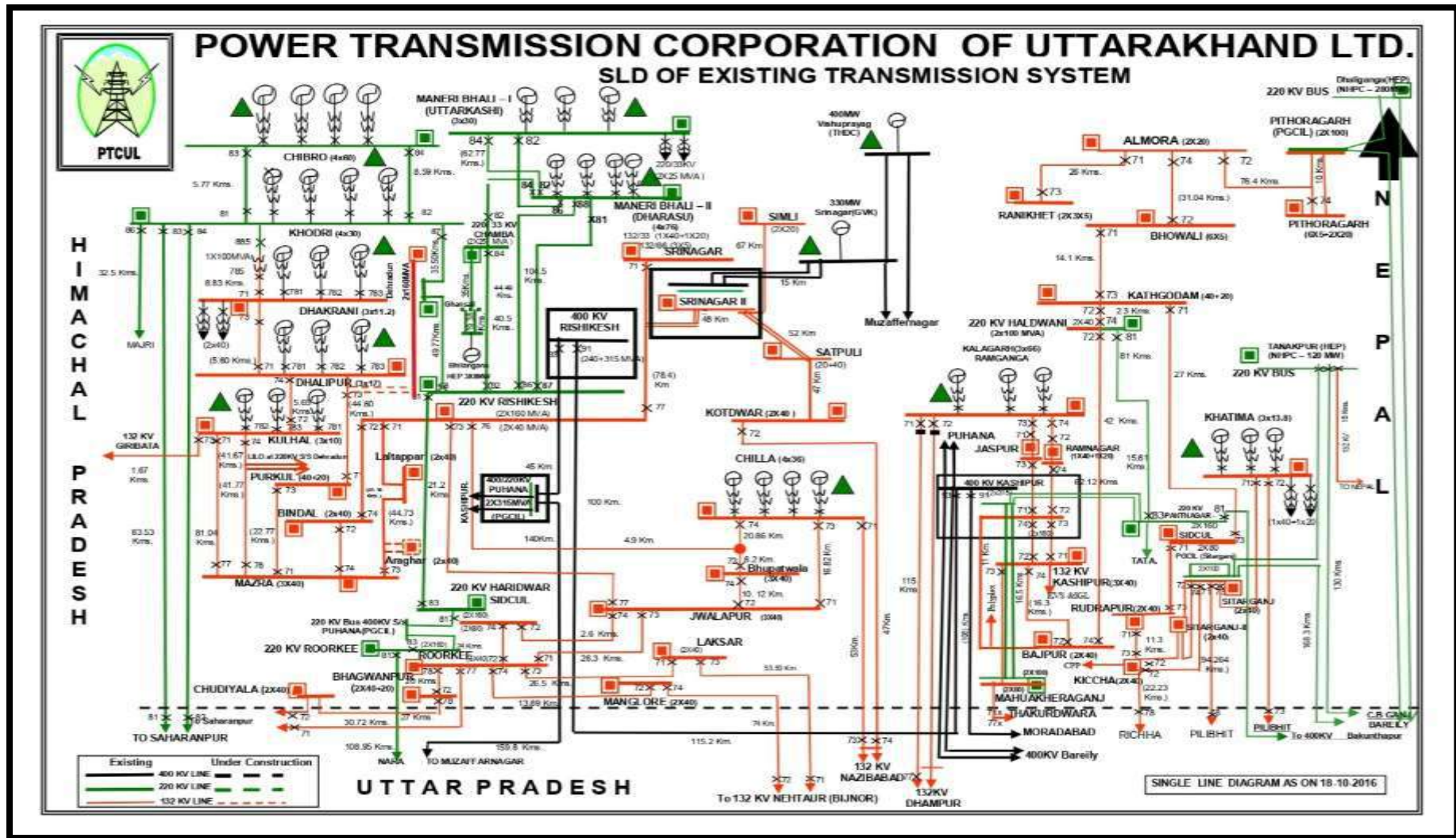

# Power Map of Uttarakhand

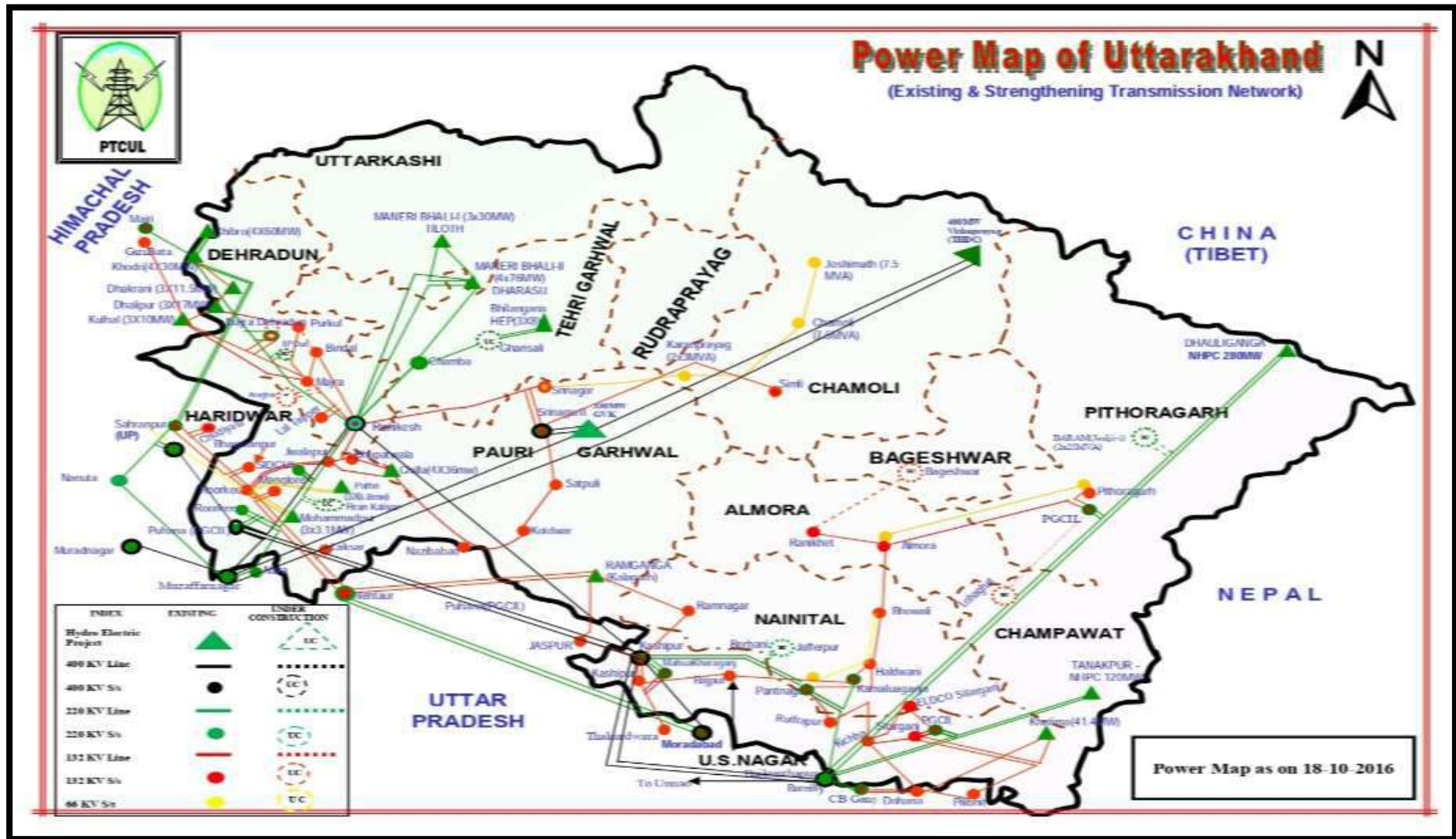



# **Power Transmission Corporation of Uttarakhand Limited**

(A Govt. of Uttarakhand Undertaking)

Corporate ID No.: U40101UR2004SGC028675

## **FINAL REPORT**

### **Protection Audit**

**220/132KV Kamaluaganja Substation**

**Submitted**

**By**



**CENTRAL BOARD OF IRRIGATION & POWER**

**NEW DELHI**





केन्द्रीय सिंचाई व शक्ति मंडल  
CENTRAL BOARD OF IRRIGATION AND POWER

25<sup>th</sup> June 2024

Order No.: 376/SE (T&C)/PTCUL/(H). dated: 29.09.2023

# Protection Audit Report

FINAL PROTECTION AUDIT REPORT OF 220/132/33 KV KAMALUAGANJA SUB-STATION UNDER POWER TRANSMISSION CORPORATION OF UTTARAKHAND LIMITED (PTCUL), UTTARAKHAND.

Submitted  
To



**Power Transmission Corporation of Uttarakhand Limited**  
(A Govt. of Uttarakhand Undertaking)  
Corporate ID No.: U40101UR2004SGC028675

## Contents

<b>Disclaimer</b> .....	6
<b>1.0. Executive Summary</b> .....	7
<b>2.0. Introduction</b> .....	9
2.1. <i>Background</i> .....	9
2.2. <i>Scope of Work</i> .....	9
2.3. <i>Audit Rationale</i> .....	10
2.4. <i>Audit Process</i> .....	11
2.5. <i>About Power Transmission Corporation of Uttarakhand (PTCUL)</i> .....	13
2.6. <i>About Central Board of Irrigation &amp; Power (CBIP)</i> .....	14
<b>3.0. Preliminary Audit of Kamaluaganja Substation</b> .....	15
3.1. <i>General Information about Sub-station</i> .....	15
3.2. <i>Audit Team</i> .....	15
3.3. <i>Recommendation of last protection checking and validation</i> .....	16
3.4. <i>Review of existing settings at substation</i> .....	16
3.5. <i>Disturbance Recorder availability for the last 6 tripping's</i> .....	16
3.6. <i>Chronic reason of tripping, if any</i> .....	16
3.7. <i>Major non-conformity/deficiency observed</i> .....	16
<b>4.0. List of Trippings</b> .....	17
<b>5.0. Observations and Recommendations</b> .....	19
5.1. <i>Reporting of all the Tripping with DR/EL</i> .....	19
5.2. <i>Development of centralized database of relay settings</i> .....	19
5.3. <i>Review of test results of relay and equipment</i> .....	20
5.4. <i>Availability of Testing Kits</i> .....	20
5.5. <i>Up-dation of PTCUL Protection Philosophy</i> .....	20
5.6. <i>Simulation based study of protection system</i> .....	21
5.7. <i>Capacity Building of protection team</i> .....	21
5.8. <i>Updated Fault Level/ Short Circuit Level and Network information</i> .....	21
5.9. <i>General Protection related observations</i> .....	21
5.10. <i>O&amp;M Manual</i> .....	21
<b>6.0. Station Specific Observation and Recommendations</b> .....	22
6.1. <i>Protection related observations and recommendations</i> .....	22
6.2. <i>Equipment related observations and recommendations</i> .....	22
6.3. <i>Auxiliary Equipment related observations and recommendations</i> .....	22
<b>Annexure – 1: Suggested List of Testing Instruments</b> .....	23
<b>Annexure – 2: Suggested List of Substation Equipments</b> .....	24

**Annexure – 3: Suggested List of Maintenance Equipments.....25**  
**Annexure – 4: Protection Code (IEGC 2023 Chapter 4).....26**  
**Annexure – 5: Third Party Protection System Checking & Validation Template for a  
Substation (IEGC 2023 Annexure – 1).....31**  
**Annexure – 6: Protection Philosophy/Protocol of Northern Region .....36**  
**Annexure – 7: Work Order & Corrigendum.....42**  
**Annexure – 8: Data Sheets .....50**

## ACRONYMS

<b>A</b>	Ampere
<b>AC</b>	Alternating Current
<b>AMP</b>	Annual Maintenance Plan
<b>CBIP</b>	Central Board of Irrigation and Power
<b>CT</b>	Current Transformer
<b>CVT</b>	Capacitive Voltage Transformer
<b>DC</b>	Direct Current
<b>DG</b>	Diesel Generator
<b>DPR</b>	Detailed Project Report
<b>DR</b>	Disturbance Recorder
<b>EL</b>	Event Logger
<b>EMTP</b>	Electromagnetic Transient Program
<b>EE</b>	Executive Engineer
<b>GPS</b>	Global Positioning System
<b>ICT</b>	Inter Connecting Transformer
<b>IEGC</b>	Indian Electricity Grid Code
<b>JE</b>	Junior Engineer
<b>KA</b>	Kilo Ampere
<b>KV</b>	Kilo Volt
<b>LBB</b>	Local Breaker Backup
<b>LEFT</b>	Earth Fault
<b>MVA</b>	Mega Volt Ampere
<b>NA</b>	Not Available
<b>NRPC</b>	Northern Regional Power Committee
<b>O&amp;M</b>	Operation & Maintenance
<b>OCC</b>	Operation Coordination Sub Committee



<b>PLCC</b>	Power Line Carrier Communication
<b>PSC</b>	Power System Sub Committee
<b>PSDF</b>	Power System Development Fund
<b>PT</b>	Potential Transformer
<b>PTCUL</b>	Power Transmission Corporation of Uttarakhand Limited.
<b>RLDC</b>	Regional Load Dispatch Centre
<b>RPC</b>	Regional Power Committee
<b>SAS</b>	Substation Automation System
<b>SE</b>	Superintendent Engineer
<b>SCADA</b>	Supervisory Control & Data Acquisition
<b>SLD</b>	Single Line Diagram
<b>SLDC</b>	State Load Dispatch Centre
<b>SOTF</b>	Switch On-To Fault
<b>SPS</b>	Special Protection Scheme
<b>T&amp;C</b>	Testing & Commissioning
<b>UJVNL</b>	Uttarakhand Jal Vidyut Nigam Ltd
<b>UPCL</b>	Uttarakhand Power Corporation Ltd
<b>WTI</b>	Winding Temperature Indicator

## Disclaimer

The protection audit has been carried out based on the guidelines provided under various documents mentioned in the report. For the purpose of audit, the auditor(s) have relied upon the data made available by the client and information & clarifications made available, in the written or verbal form, by the officials of clients during site visit and later.

The report is not for public distribution and has been furnished solely for information and must not be reproduced or redistributed to others, except those concerned. No one can use the report as a base for any claim, demand or cause of action and, also no one is responsible for any loss incurred based upon the content of this report.

While every effort is made to ensure the accuracy and completeness of information contained, CBIP takes no responsibility and assumes no liability for any error/ omission or accuracy of the information. Recipients of this material should rely on their own judgments and conclusions from relevant sources before taking any decision.

## 1.0. Executive Summary

PTCUL awarded the work of Third-Party Protection Audit of 2 nos. 400kV and 8 nos. 220kV substations of PTCUL (“Utility”) to CBIP. CBIP planned the audit as per Audit process provided under Protection Code within Indian Electricity Grid Code 2023. In addition, the guidelines of Ramakrishna Committee for checking and validation and NRPC guidelines for Third Party Audit were also adhered too. The CBIP manual on protection (manual no 247-Revised), NRPC protection philosophy were also referred too.

As a part of audit process, utility was asked to provide set of information before start of audit. Team from CBIP consisting of Mr. Vijay Barthwal, Mr. M.R. Chauhan & Mr. Rounak Sen visited 220/132KV Kamaluaganja Substation during 30<sup>th</sup> January – 2<sup>nd</sup> February 2024 and preliminary audit report was submitted on the spot. The representatives of utility were present during this process. Some more information was sought from the Utility.

Based on the data made available by Utility, draft of final report was submitted to Utility and after discussions, report was finalized. The details of audit process, data made available by Utility, observations from preliminary report and detailed observations and recommendations are provided in this report. Key observations and recommendations are summarized below under 2 heads.

### **General Observations and Recommendations for Organization Level implementation**

01. It is recommended that each substation to have a central repository for tripping reports, along with Time Synchronized DR/EL reports and analysis. A dedicated PC can be provided at each substation for the purpose.
02. The protection philosophy adopted by Utility, in general, is in alignment with protection philosophy adopted by NRPC. As the NRPC has recently updated the protection philosophy, PTCUL in consultation with SLDC may update protection philosophy for network not covered by NRPC too, if needed, and implement the same.
03. It is recommended that latest recommended relay settings, as per the NRPC protocol for 220KV & above Substations, along with setting calculations & parameters used for all the relays, be kept at each substation. This will help in proper fault analysis and ascertaining relay healthiness. Similarly, Relay settings for sub-stations below 220kV, based on any such protocol by SLDC, along with setting calculations and line parameters also needs to be maintained.
04. It is recommended that the detailed reports of test results for the relays and switchyard equipments be maintained at sub-station level.

05. Based on “Draft O&M Manual” of PTCUL and discussions with their officials, a list of testing equipment is suggested and enclosed at Annexure - 1. Also, a list of switchyard maintenance equipment is placed at annexure -3. It is recommended that the necessary testing and maintenance equipment at substation/Sub-division/Division be arranged for regular testing and maintenance of equipment at substations.
06. Simulation based studies or EMTP Studies should be carried out by the Utility, as per the requirement of IEGC-2023.
07. For the protection system and SAS, PTCUL may undertake capacity building exercise for the officials involved in these activities.
08. It is recommended that the updated network information and short circuit level should be periodically reviewed and maintained at central level for revising the setting as per requirement.
09. It is suggested that utility may carry out exhaustive safety and technical audit of sub-stations apart from protection audit, either internally or thru’ third party for implementing the best practices in the sub-station.
10. It is suggested that the existing draft O&M manual be updated to take care of latest developments.

#### **Observations and Recommendations for 220/132KV Kamaluaganja Substation**

01. The station is named interchangeably as Haldwani and Kamaluaganga. The protection audit of substation is carried out for first time.
02. Considering the frequent tripping of 132KV Bazpur line on transient faults, to maintain uninterrupted operations, it is suggested that PTCUL to examine the possibility of auto-reclosure on this feeder.
03. It is suggested that possibility of 220kV Bus-bar protection be examined by PTCUL.
04. 132KV and 33KV buses are sectionalized for flexible operation. It is recommended that, the Station SLD is to be marked with all sections properly.
05. Emergency DG set operation is in manual mode. It is suggested to keep the DG set in Auto mode.
06. Based on inputs provided by utility and analysis of data a list of suggested switchyard and maintenance equipment for replacement is provided in Annexure – 2.

## 2.0. Introduction

### 2.1. Background

The work has been awarded to the Central Board of Irrigation & Power (CBIP) vide Work Order Number: 376/SE (T&C)/PTCUL/(H), dated: 29.09.2023 for Protection Audit of 02 Nos. 400 kV and 08 Nos. 220 kV Sub-Stations at Uttarakhand, for Power Transmission Corporation of Uttarakhand Limited (PTCUL) in reference to the offer submitted by CBIP to PTCUL vide ref. no. P-1/CBIP/PTCUL/Audit/2023, dated: 11.09.2023. A Kick-Off Meeting was held between PTCUL and CBIP at the office of SE (T&C), PTCUL, Kathgodam, Haldwani on 26<sup>th</sup> October 2023. Detailed discussions were held regarding process and methodology of Execution and Submission of reports of Protection Audit. As per the above-mentioned meeting, a corrigendum was released by PTCUL vide ref. no. 394/SE (T&C)/PTCUL/(H), dated: 26.10.2023.

**As per the given order, the protection audit of following sub-stations is to be carried out**

1. 400kV Rishikesh
2. 400kV Kashipur
3. 220kV Chamba
4. 220kV Rishikesh
5. 220kV Roorkee
6. 220kV Haridwar (SIDCUL)
7. 220kV Jhajra
8. 220kV Pantnagar
9. 220kV Haldwani
10. 220kV Mahuakheraganj

### 2.2. Scope of Work

Review of the implemented protection schemes/philosophy for 400/220 kV substations which includes protection of transmission lines, interconnecting transformers, line/bus reactors, bus bar, bus couplers etc. with respect to tripping in last one year as per latest guidelines of Ramakrishna committee/ CBIP/NRPC/International best practices, which includes review of the following:

- a. *Adequacy of primary and backup protection settings for protected equipment and suggest corrective measures.*
- b. *Availability/healthiness of PLCC communication links used for protection systems.*
- c. *Healthiness/adequacy of 220/110/50V DC system available at substations for protection application.*
- d. *Availability/healthiness of GPS system and time synchronization facility used for protection.*
- e. *Availability/healthiness of recording instruments like DRs /ELs for transmission lines protection.*
- f. *Test reports for assessing the healthiness of circuit breakers, CT & CVT based upon available test reports at sites.*
- g. *Field inspection of protection device for obsolescence of technology, suitability and healthiness.*
- h. *Prepare recommendation for replacement of obsolescence relays with compatible numerical relays will be provided.*
- i. *Checking of availability of DG Set / auxiliary DC supply at substations.*

### **2.3. Audit Rationale**

- a. PTCUL (Utility) has submitted a DPR for Replacement of certain equipment under PSDF scheme to Grid-India. Grid-India has asked PTCUL to carry out protection audit of certain substations.
- b. In addition, as per CERC IEGC 2023 Chapter-04 (Protection Code) Para - 15 (2) “All users shall also conduct third party protection audit of each substation at 220KV and above (132KV and above in NER) once in 5 years or earlier as advised by the respective RPC”.
- c. As per Para – 15 (4) of said Code, “The third-party protection audit report shall contain information sought in the format enclosed as Annexure–1. The protection audit reports, along with action plan for rectification of deficiencies detected, if any, shall be submitted to the respective RPC and RLDC or SLDC, as the case may be, within a month of submission of third-party audit report. The necessary compliance to such protection audit report shall be followed up regularly in the respective RPC”.
- d. Subsequently NRPC issued protection philosophy for Northern region developed in compliance of IEGC 2023, Version 2.0 which was approved in 71<sup>st</sup> NRPC meeting held on 29.01.2024. Accordingly, protection audit of 220KV and above Substations is being carried out by CBIP, as per Annexure -1 of IEGC-2023.

## 2.4. *Audit Process*

- PTCUL shall provide the following documents:
  - a. The Network Diagram, covering the relevant assets
  - b. Latest relay settings adopted and calculations for respective sub-stations and transmission lines.
  - c. Annual maintenance plan (AMP), including the schedule and activities covered under AMP
  - d. Any specific issues covered under OCC and/or PSC of NRPC for relevant assets.
- For each sub-station, check-list shall be provided by PTCUL. During field visit, the information shall be verified.
- The minimum set of points on which checking and validation shall be carried out is provided as per annexure - 4 for the following available power system elements at station, as per attached formats:

<b>Sl. No.</b>	<b>Elements</b>
<b>1</b>	Transmission Line
<b>2</b>	Bus Reactor/Line Reactor
<b>3</b>	Inter-connecting Transformer
<b>4</b>	Busbar
<b>5</b>	AC auxiliary system
<b>6</b>	DC auxiliary system
<b>7</b>	Communication system
<b>8</b>	Circuit Breaker Details
<b>9</b>	Current Transformer Details
<b>10</b>	Capacitive Voltage Transformers Details
<b>11</b>	Any other equipment/system relevant for protection system operation

- During field visit, no testing of equipment and relay shall be carried out. The visual inspection, operational log shall be considered for audit purpose, apart from the documents provided by PTCUL
- A calibrated multi-meter shall be provided at sub-station for checking AC and DC voltages and currents online, wherever feasible, without impacting the sub-station operations.

- The preliminary report shall be prepared on the site and shall be signed by all the parties present, as given below:

Sl. No.	Issues	Remarks
1	Recommendation of last protection checking and validation	Status of works and pending issues if any
2	Review of existing settings at substation	Recommended Action
3	Disturbance Recorder out/ available for last 6 tripping's (Y/N)	Recommended Action
4	Chronic reason of tripping, if any	Recommended Action
5	Major non-conformity/deficiency observed	Recommended Action

- **The Final summary shall specifically mention minimum following points:**

- The settings and scheme adopted are in line with agreed protection philosophy or any accepted guidelines (e.g., Ramakrishna guidelines or CBIP manual based).
- The deviations from the RPC protection philosophy, if any and reasons for taking the deviations shall be recorded.
- All the major general deficiency shall be listed in detail along with remedial recommendations.
- The cases of protection maloperation (last 1 year) shall be analysed from tripping reports and the causes of failure along with corrective actions and recommendations based on the findings.



## 2.5. *About Power Transmission Corporation of Uttarakhand (PTCUL)*

The State of Uttarakhand's power transmission utility, PTCUL, was formerly known as Uttaranchal. According to the Uttar Pradesh State Reorganization Act 2000, this 27<sup>th</sup> state of the republic of India was formed on November 9, 2000, by dividing the Himalayan and surrounding North-Western districts of Uttar Pradesh.

The State of Uttaranchal in exercise of the power granted to it under section 63(4) of the State Re-Organization Act, 2000, formed two separate companies in power sector:

- Uttaranchal Jal Vidyut Nigam Ltd. (UJVNL) – For generation of Hydro-Electricity in the State.
- Uttaranchal Power Corporation Ltd. (UPCL) – For Transmission and Distribution of Electricity in the state.

Enactment of the Electricity Act 2003, a distinct watershed in the Indian Power Sector, made it mandatory for all the States to restructure their SEBs. As per the provisions of Electricity Act 2003, the State Government separated power transmission business from UPCL which was left only with distribution of electricity.

In order to manage Power Transmission Operations, a new company called Power Transmission Corporation of Uttaranchal Ltd. was established. On 27<sup>th</sup> May, 2004, the firm was formed as a Government Company in accordance with section 617 of the Companies Act, 1956. It began operating from 1<sup>st</sup> June, 2004.

The company's corporate and registered office is located in Vidyut Bhawan, Saharanpur Road, Majra, Dehradun, next to the ISBT Crossing.

## ***2.6. About Central Board of Irrigation & Power (CBIP)***

The Government of India established the Central Board of Irrigation and Power in 1927, making it a Premier Institution. For the past 93 years, CBIP has provided committed services to the nation's professional associations, engineers, and individuals involved in the power, water resources, and renewable energy sectors. While serving the country equally and to great honour, CBIP has developed into an esteemed institution of international significance. CBIP is Indian chapter for 10 international organizations related to Power & Water resources sectors.

CBIP is involved in executing various activities such as, International Conferences, Technical Documents Publications, Training Activities, Research & Development, Consultancy Services including Technical, Protection & Safety Audits.

### 3.0. Preliminary Audit of Kamaluaganja Substation

#### 3.1. General Information about Sub-station

Sl. No.	Particulars	Details
1	Substation Name	220/132/33 kV Kamaluaganja Substation
2	Name of Owner Utility	Power Transmission Corporation of Uttarakhand Limited (PTCUL)
3	Voltage Level (s) or highest voltage level	220/132/33 kV
4	Short circuit current rating of all equipment (for all voltage level)	220 kV = 50 kA, 132 kV = 40 kA
5	Date of commissioning of the substation	15 <sup>th</sup> May 2002
6	Checking and validation date	30 <sup>th</sup> January 2024 – 2 <sup>nd</sup> February 2024

#### 3.2. Audit Team

##### Audit Team (CBIP):

- Mr. Vijay Barthwal
- Mr. M.R. Chauhan
- Mr. Rounak Sen

##### PTCUL Representative:

- Mr. Asim Baig – Executive Engineer
- Mr. Ashutosh Pokhriyal – Assistant Engineer
- Mr. Mahesh Barolia – Junior Engineer

### ***3.3. Recommendation of last protection checking and validation***

No Protection Audit was conducted previously

### ***3.4. Review of existing settings at substation***

- a. Utility has provided relay settings adopted for various feeders and transformers.
- b. All relays are numeric, testing is done using automatic test kits. Detailed test record is not kept.

### ***3.5. Disturbance Recorder availability for the last 6 tripping's***

- a. DR and EL is taken from relays, as per requirement, but no central record is kept.
- b. Relays are not Time synchronised.

### ***3.6. Chronic reason of tripping, if any***

- a. 132KV Bazpur line faces frequent tripping, as it passes thru reserved forest area and path of migratory birds.

### ***3.7. Major non-conformity/deficiency observed***

- a. No Bus-bar protection is provided.
- b. Emergency DG set operation is in manual mode.
- c. No carrier aided inter-tripping is provided.
- d. All isolators are manually operated, due to old age.
- e. Due to absence of PLCC system, 48V battery Chargers and Battery is not available. One stand-alone 48V system is being used for SCADA/ OPGW purpose.
- f. 132 kV and 33kV buses are sectionalized for flexible operations. Same is not clearly visible in SLD at sub-station.
- g. Separate 33kV transfer bus is provided, in case of exigencies, permanent jumpers are used for transferring the load on TBC.

## 4.0. List of Trippings

Name of Feeder/TF	Type of Relay/Scheme	Date & Time of Tripping	Date & Time of Closing	Flag Observed	Affected Load/Generation	Analysis of Tripping	Category Code
132KV Bazpur Line CB 72	Siemens	6-11-22 1:22 Hrs	6-11-22 1:38 Hrs	Flags – Zone 1, Fault Loop L2E Fault Current – IL1=0.07KA, IL2=2.37KA, IL3=0.05KA, distance-21.6km	NIL	Bird fault near tower no. 40	LEFT
		6-11-22 4:55 Hrs	6-11-22 5:08 Hrs	Flags – Zone 1, Fault Loop L2E Fault Current – IL1=0.06KA, IL2=2.36KA, IL3=0.04KA, distance - 21.6km			
100MVA T/F 1 CB – 881/781	Siemens	28-03-23 10:17 Hrs	28-03-23 17:36 Hrs	Flag – Differential Trip, Fault Current (HV) L1=0.10KA, L2=0.13KA, L3=0.89KA, Fault Current (LV) L1=0.16KA, L2=0.19KA, L3=6.33KA	NIL	Due to B-Phase LA (LV side) burst	SICT
132KV Bazpur CB 72	Siemens	16-05-23 21:12 Hrs	Under S/D	Flag – Zone 1, Trip, Fault Current – L1=3.78KA, L2=0.72KA, L3=1.92KA	NIL	Conductor Broken	LPPT
132KV Bazpur CB 72	Siemens	23-05-23 23:02 Hrs	24-05-23 00:35 Hrs Under S/D	Flag – Zone 1, Operated, Fault Loop L3E, Fault Current – IL1=0.20KA, IL2=0.35KA, IL3=2.58KA, distance – 10.8km	NIL	Due to bad weather condition & thunderstorm	LEFT
132KV Bazpur CB 72	Siemens	05-06-23 16:38 Hrs	05-06-23 17:13 Hrs	Flag – Distance Protection OPTD, Zone 1 Trip, Fault Loop L3L1, Fault Current – IL1=2.75KA, IL2=0.15KA, IL3=2.59KA, distance – 12.1km	NIL	TLF	LPPT
132KV Bazpur CB 72 (Line Length – 35.5km)	Siemens	14-07-23 14:01 Hrs	14-07-23 14:17 Hrs	Flag – Distance Protection OPTD, Zone 1 Trip, Fault Loop L3L1, Fault Current – IL1=2.75KA, IL2=0.15KA, IL3=2.59KA, distance – 12.1km	NIL	Due to Bird Fault at tower no. 29 as informed by O&M wing	LEFT
132KV Bazpur CB 72 (Line Length – 35.5km)	Siemens	07-09-23 22:50 Hrs	08-09-23 9:21 Hrs	Flag – Distance Protection OPTD, Zone 1 Trip, Fault Loop L3L1, Fault Current – L1=2.62KA, L2=0.13KA, L3=2.73KA, distance – 16km	NIL	Tree Fallen between at tower no. 56, 57 as informed by O&M wing	LPPT
40MVA T/F III	Siemens	05-10-23 18:10 Hrs	05-10-23 20:58 Hrs	Flag – Diff. Protection OPTD, Fault Current (HV) Ia=31.55A, Ib=32.74A, Ic=1.022KA (LV). Ia=2.547A, Ib=6.201A, Ic=3.919KA	NIL	Due to R-Phase LA (LV) Burst	NA
132KV Bazpur CB 72 (Line Length – 35.5km)	Siemens	06-10-23 23:40 Hrs	06-10-23 23:52 Hrs	Flag – Distance Protection OPTD, Zone 2 Trip, Fault Loop L2E, Fault Current – L1=0.01KA, L2=2.28KA, L3=0.01KA, distance – 30.9km	NIL	Due to Bird Fault between tower no. 10, 11 as informed by O&M wing	LEFT
132KV Bazpur CB 72 (Line Length – 35.5km)	Siemens	09-10-23 21:57 Hrs	09-10-23 22:17 Hrs	Flag – Distance Protection OPTD, Zone 2 Trip, Fault Loop L2E, Fault Current – L1=0.01KA, L2=2.22KA, L3=0.01KA, distance – 31.8km	NIL	Due to Bird Fault between tower no. 10, 11 as informed by O&M wing	LEFT
132KV Bazpur CB	Siemens	10-10-23 1:27 Hrs	10-10-23 1:44 Hrs	Flag – Distance Protection OPTD, Zone 2 Trip, Fault Loop	NIL	Due to Bird Fault	LEFT

Name of Feeder/TF	Type of Relay/Scheme	Date & Time of Tripping	Date & Time of Closing	Flag Observed	Affected Load/Generation	Analysis of Tripping	Category Code
72 (Line Length – 35.5km)				L1E, Fault Current – L1=2.18KA, L2=0.00KA, L3=0.01KA, distance – 33.3km		between tower no. 10, 11 as informed by O&M wing	
132KV Bazpur CB 72 (Line Length – 35.5km)	Siemens	15-10-23 21:30 Hrs	15-10-23 21:43 Hrs	Flag – Distance Protection OPTD, Zone 2 Trip, Fault Loop L2E, Fault Current – L1=0.01KA, L2=2.27KA, L3=0.01KA, distance – 30.8km	NIL	Y-Phase disc puncture at tower no. 38 due to bird fault, as informed by O&M wing	LEFT

## 5.0. Observations and Recommendations

### 5.1. Reporting of all the Tripping with DR/EL

- a. For the interstate lines, as per IEGC clause 37.2(c) and clause 15.3 of CEA grid standard, all the DR/EL reports shall be uploaded on Web Based Tripping Monitoring System “http://103.7.128.184/Account/Login.aspx” within 24 hours of the events. These are being submitted by substation to NRLDC portal, however the record of the same is not kept at substation level.

Status of submission of FIR/DR/EL/Tripping Report on NR Tripping Portal																	
Time Period: 1st January 2024 - 31st January 2024																	
S. No.	Utility	Total No. of tripping	First Information Report (Not Received)		Disturbance Recorder (Not Received)		Disturbance Recorder (NA) as informed by utility		Event Logger (Not Received)		Event Logger (NA) as informed by utility		Tripping Report (Not Received)		Tripping Report (NA) as informed by utility	Tripping Report (Not Received)	Remark
			Value	%	Value	%	Value	%	Value	%	Value	%					
36	SLDC-PS	29	2	7	13	6	57	13	5	54	36	0	55				
37	SLDC-RS	130	12	9	23	11	19	23	9	19	39	0	30				
38	SLDC-UK	6	0	0	0	4	0	0	4	0	1	3	33				DR, EL & Tripping report need to be submitted
39	SLDC-UP	80	10	13	11	9	15	12	10	17	11	1	14				
40	STERLITE	1	0	0	0	0	0	0	0	0	0	1	0				Details received
41	TANAKPUR-NH	4	1	25	1	0	25	1	0	25	1	0	25				DR, EL & Tripping report need to be submitted
42	LUNICHAHAR-NT	1	0	0	0	0	0	0	1	0	0	0	0				Details received
Total in NR Region		520	147	28	169	69	37	171	70	38	185	17	37				

*As per the IEGC provision under clause 37.2 (c), detailed tripping report along with DR & EL has to be furnished within 24 hrs of the occurrence of the event*

Ref: NRPC 216 OCC Agenda (Annexure B.VIII)

- b. For the tripping of intra-state lines, the brief tripping reports are submitted to Divisional office. The DR/EL reports are downloaded by respective officials and forwarded, as per need basis. The record of these DR/EL is not kept at substations
- c. It is recommended that each substation to have a central repository of such tripping reports, along with DR/EL reports and analysis. A dedicated PC can be kept for this.

### 5.2. Development of centralized database of relay settings

- a. In 48th TCC & 70th NRPC Meeting (held on 17-18 Nov 2023), NRPC Committee has approved for development of a portal through PSDF for Centralized database containing details of relay settings for grid elements connected to 220 KV and above. Portal shall have other features including protection setting calculation tool. A nodal officer shall be providing this data at central portal.
- b. The relay settings for below 220KV are to be calculated by SLDC and/or central level. The relays are tested by substation officials as per need basis, but the record of

recommended settings/ calculation is not kept at substation level. This makes it difficult to validate the settings and test results, in case of relay testing.

- c. It is recommended that latest recommended relay settings, as decided by RLDC for 220KV & above and by SLDC below 220KV along with setting calculations & parameters used for all the relays be kept at substation level. This will help in proper fault analysis and ascertaining relay healthiness.

### **5.3. *Review of test results of relay and equipment***

- a. Testing of most of the equipment is carried out, as per availability of shut-down and testing equipment. After testing, the test records are summarily recorded in testing register, with remarks as “tested. OK”.
- b. For the numeric relay testing, the testing is carried out by supplier at the time of installation and subsequently as per need basis, including at the time of change in settings.
- c. A draft O&M manual is available at PTCUL web-site, which includes various tests and their frequency, along with results. This manual is based on CERC/SERC regulations of 2004-2008. It is recommended that this manual may be updated and implemented and record of test values may be kept for future reference.

### **5.4. *Availability of Testing Kits***

- a. The availability of testing equipment is limited at each substation. For comprehensive testing of equipment, as per above para, sufficient testing kits at each substation/Sub-division/ Division level are required.
- b. Based on the O&M manual, it is recommended that sufficient quantity of testing instruments be made available at sites for regular testing of equipment. A suggested list of Testing Equipment is attached at Annexure – 1.

### **5.5. *Up-dation of PTCUL Protection Philosophy***

The protection philosophy adopted by Utility, in general, is in alignment with protection philosophy adopted by NRPC. As the NRPC has recently updated the protection philosophy, PTCUL in consultation with SLDC may update protection philosophy for network not covered by NRPC, if needed, and implement the same.



### **5.6. *Simulation based study of protection system***

As per IEGC, protection code, during audit the relay settings to be adopted shall be validated with simulation based or EMTP studies and details shall be enclosed in report. The current scope of audit was excluding these studies, therefore, Simulation based or EMTP Studies should be carried out by the Utility, as per the requirement of Grid Code.

### **5.7. *Capacity Building of protection team***

During the discussions with officials at site, it was observed that the teams responsible for the protection system and SAS, needs to be updated on current trends on protection system, communication schemes and Sub-station automation. Utility may undertake capacity building exercise for the officials involved in these activities.

### **5.8. *Updated Fault Level/ Short Circuit Level and Network information***

The fault level/ short circuit level for each substation is being calculated at central level. Such studies are carried out, as and when new elements are added in the network. This has impact on relay settings parameters and equipment ratings. It is recommended that the updated network information and short circuit level be maintained at central level for revising the setting as per requirement.

### **5.9. *General Protection related observations***

The study of Fire protection system/ Nitrogen Injection Fire Protection System, Lightning Protection system, Earthing Mat/ Earthing Protection are not covered under protection audit. Utility may get a comprehensive technical and safety audit carried out internally or thru third party and corrective action for any discrepancy be taken up accordingly.

### **5.10. *O&M Manual***

The Utility has a draft O&M manual uploaded on its website, which is being referred by working level officials as a guideline for regular O&M and testing functions. This manual needs to be updated to incorporate recent developments and approved for regular use in all sub-stations to bring uniformity in O&M and testing practices across the utility.

## **6.0. Station Specific Observation and Recommendations**

### **6.1. Protection related observations and recommendations**

- a. Based on analysis of line tripping during last 12 months, it is observed that 132KV Bazpur line faced 10 tripping in 12 months, as it passes thru reserved forest area and path of migratory birds. For uninterrupted operations, PTCUL may examine the possibility of providing auto-reclosure on this line.
- b. No Bus-bar protection is provided. It is suggested that PTCUL may examine possibility of providing Bus-bar protection at 220KV level.
- c. 132KV and 33kV buses are sectionalized at different places for flexible operations. Same is not properly updated in SLD at sub-station. It is recommended to keep the SLD updated.

### **6.2. Equipment related observations and recommendations**

Many of the equipment are recently replaced. Any requirement of equipment and spares may be reviewed by PTCUL.

In addition, it is recommended that sufficient quantity of maintenance equipments be made available at sites. A suggested list of Maintenance Equipment is attached at Annexure – 3.

### **6.3. Auxiliary Equipment related observations and recommendations**

- a. Emergency DG set operation is in manual mode. Necessary action may be taken to keep the DG set in Auto mode.
- b. No carrier aided inter-tripping is provided. Due to absence of PLCC system, 48V battery Chargers and Battery are also not available. One stand-alone 48V system is being used for SCADA/ OPGW purpose. The SCADA is used to receive the trip signal for SPS scheme.

## Annexure – 1: Suggested List of Testing Instruments

CBIP suggests the following list of testing instruments based on the approved O&M manual

Sl. No.	Testing Instruments
1	DCRM for Circuit Breaker
2	DC Earth Fault Locator
3	SF6 Gas Density Monitor
4	SF6 Gas Leakage detector/ Imaging Camera
5	CB Analyser
6	Earth Resistance Tester
7	Portable Digital Selective Level Meter cum Level Generator
8	Selective Level Generator
9	LA Leakage Current Analyser
10	Digital Multi-meter
11	Tong Tester
12	Tan Delta Test Kit
13	Digital Leakage Clamp Meter
14	Phase Sequence Indicator
15	Megger (5 kV)
16	Digital Capacitance Meter
17	CT Polarity Tester
18	PT Test Set

## Annexure – 2: Suggested List of Substation Equipments

The suggested list of Substation Equipments keeping in mind the necessity for the modernization and upgradation of substations.

Sl. No.	Equipment	Unit	Quantity
<b>A</b>	<b>400KV Equipment</b>		
1	420KV Current Transformer 1 phase	Nos	30
2	420KV CVT 1 phase	Nos	15
<b>B</b>	<b>220KV Equipment</b>		
1	245KV Current Transformer (5 Core), Class 0.2s (1ph) 1000/500/1	Nos	12
2	245KV Current Transformer (5 Core), Class 0.2s (1ph) 1600/800/1	Nos	30
3	245KV CVT 1 Ph	Nos	18
<b>C</b>	<b>132KV Equipment</b>		
1	145KV Circuit Breaker 3PH	Nos	8
2	145KV Current Transformer 1Ph	Nos	30
3	145KV CVT	Nos	18
4	145KV HYBRID Plug and switch system (PASS) Including breaker and disconnecter at both end for 132 kV Main & Transfer Bus	Nos	2
<b>D</b>	<b>33KV Equipment</b>		
1	33KV Circuit Breaker	Nos	2
2	33KV Isolator 3Ph	Nos	6
3	33KV Surge Arrestor 1 Ph (polymer)	Nos	6

### Annexure – 3: Suggested List of Maintenance Equipments

Sl. No.	Equipment
1	Oil Filter Machine
2	SF6 Gas Handling Plant
3	SF6 Gas Density Monitor
4	Thermo-Vision Camera Lines and Sub-Station
5	Binocular Vision Camera
6	SF6 Gas Leakage Imaging Camera
7	LA Leakage Current Analyser
8	Online DGA
9	Oil BDV Kit
10	Hydraulic Crimping Tool for different Types of ACSR Conductor
11	Hydraulic Conductor Cutter
12	Fork Lift 5 Ton Capacity
13	Digital Leakage Clamp Meter

A mobile van with test kits can be kept for optimizing the resources at various substations

## **Annexure – 4: Protection Code (IEGC 2023 Chapter 4)**

- **General**

1. This chapter covers the protection protocol, protection settings and protection audit plan of electrical systems.
2. There shall be a uniform protection protocol for the users of the grid:
  - a) for proper co-ordination of protection system in order to protect the equipment/system from abnormal operating conditions, isolate the faulty equipment and avoid unintended operation of protection system;
  - b) to have a repository of protection system, settings and events at regional level;
  - c) specifying timelines for submission of data;
  - d) to ensure healthiness of recording equipment including triggering criteria and time synchronization; and
  - e) to provide for periodic audit of protection system.

- **Protection protocol**

1. All users connected to the integrated grid shall provide and maintain effective protection system having reliability, selectivity, speed and sensitivity to isolate faulty section and protect element(s) as per the CEA Technical Standards for Construction, the CEA Technical Standards for Connectivity, the CEA (Grid Standards) Regulations, 2010, the CEA Technical Standards for Communication and any other applicable CEA Standards specified from time to time.
2. Back-up protection system shall be provided to protect an element in the event of failure of the primary protection system.
3. RPC shall develop the protection protocol and revise the same, after review from time to time, in consultation with the stakeholders in the concerned region, and in doing so shall be guided by the principle that minimum electrical protection functions for equipment connected with the grid shall be provided as per the CEA Technical Standards for Construction, the CEA Technical Standards for Connectivity, the CEA Technical Standards for Communication, the CEA (Grid Standards) Regulations, 2010, the CEA (Measures relating to Safety and Electric Supply) Regulations, 2010, and any other CEA standards specified from time to time.

4. The protection protocol in a particular system may vary depending upon operational experience. Changes in protection protocol, as and when required, shall be carried out after deliberation and approval of the concerned RPC.
5. Violation of the protection protocol of the region shall be brought to the notice of concerned RPC by the concerned RLDC or SLDC, as the case may be.

- **Protection settings**

1. RPCs shall undertake review of the protection settings, assess the requirement of revisions in protection settings and revise protection settings in consultation with the stakeholders of the respective region, from time to time and at least once in a year. The necessary studies in this regard shall be carried out by the respective RPCs. The data including base case (peak and off-peak cases) files for carrying out studies shall be provided by RLDC and CTU to the RPCs:
2. All users connected to the grid shall:
  - a) furnish the protection settings implemented for each element to respective RPC in a format as prescribed by the concerned RPC;
  - b) obtain approval of the concerned RPC for,
    - i. any revision in settings, and,
    - ii. implementation of new protection system;
  - c) intimate to the concerned RPC about the changes implemented in protection system or protection settings within a fortnight of such changes;
  - d) ensure correct and appropriate settings of protection as specified by the concerned RPC.
  - e) ensure proper coordinated protection settings.
3. RPCs shall:
  - a) maintain a centralized database and update the same on periodic basis in respect of their respective region containing details of relay settings for grid elements connected to 220 KV and above (132 KV and above in NER). RLDCs shall also maintain such database.
  - b) carry out detailed system studies, once a year, for protection settings and advise modifications / changes, if any, to the CTU and to all users and STUs of their respective regions. The data required to carry out such studies shall be provided by RLDCs and CTU.

- c) provide the database access to CTU and NLDC and to all users, RLDC, SLDCs, and STUs of the respective regions. The database shall have different access rights for different users.
4. The changes in the network and protection settings of grid elements connected to 220KV and above (132 KV and above in NER) shall be informed to RPCs by CTU and STUs, as the case may be.

The elements of network below 66KV and radial in nature which do not impact the National Grid may be excluded as finalized by the respective RPC.

- **Protection audit plan**

1. All users shall conduct internal audit of their protection systems annually, and any shortcomings identified shall be rectified and informed to their respective RPC. The audit report along with action plan for rectification of deficiencies detected, if any, shall be shared with respective RPC for users connected at 220 KV and above (132 KV and above in NER).
2. All users shall also conduct third party protection audit of each substation at 220 KV and above (132 KV and above in NER) once in five years or earlier as advised by the respective RPC.
3. After analysis of any event, each RPC shall identify a list of substations / and generating stations where third-party protection audit is required to be carried out and accordingly advise the respective users to complete third party audit within three months.
4. The third-party protection audit report shall contain information sought in the format enclosed as Annexure–1. The protection audit reports, along with action plan for rectification of deficiencies detected, if any, shall be submitted to the respective RPC and RLDC or SLDC, as the case may be, within a month of submission of third-party audit report. The necessary compliance to such protection audit report shall be followed up regularly in the respective RPC.
5. Annual audit plan for the next financial year shall be submitted by the users to their respective RPC by 31<sup>st</sup> October. The users shall adhere to the annual audit plan and report compliance of the same to their respective RPC.
6. Users shall submit the following protection performance indices of previous month to their respective RPC and RLDC on monthly basis for 220 KV and above (132 KV and above in NER) system, which shall be reviewed by the RPC:
  - c. The Dependability Index defined as



$$D = \frac{N_c}{N_c + N_f}$$

where,

$N_c$  is the number of correct operations at internal power system faults and

$N_f$  is the number of failures to operate at internal power system faults.

- d. The Security Index defined as

$$S = \frac{N_c}{N_c + N_u}$$

where,

$N_c$  is the number of correct operations at internal power system faults

$N_u$  is the number of unwanted operations.

- e. The Reliability Index defined as

$$R = \frac{N_c}{N_c + N_i}$$

where,

$N_c$  is the number of correct operations at internal power system faults

$N_i$  is the number of incorrect operations and is the sum of  $N_f$  and  $N_u$

7. Each user shall also submit the reasons for performance indices less than unity of individual element wise protection system to the respective RPC and action plan for corrective measures. The action plan will be followed up regularly in the respective RPC.
8. In case any user fails to comply with the protection protocol specified by the RPC or fails to undertake remedial action identified by the RPC within the specified timelines, the concerned RPC may approach the Commission with all relevant details for suitable directions.

- **System Protection Scheme (SPS)**

1. SPS for identified system shall have redundancies in measurement of input signals and communication paths involved up to the last mile to ensure security and dependability.
2. For the operational SPS, RLDC or NLDC, as the case may be, in consultation with the concerned RPC(s) shall perform regular load flow and dynamic studies and mock testing for reviewing SPS parameters & functions, at least once in a year.
3. RLDC or NLDC shall share the report of such studies and mock testing including any short comings to respective RPC(s). The data for such studies shall be provided by CTU to the concerned RPC, RLDC and NLDC.
4. The users and SLDCs shall report about the operation of SPS immediately and detailed report shall be submitted within three days of operation to the concerned RPC and RLDC in the format specified by the respective RPCs.
5. The performance of SPS shall be assessed as per the protection performance indices specified in these Regulations. In case, the SPS fails to operate, the concerned User shall take corrective actions and submit a detailed report on the corrective actions taken to the concerned RPC within a fortnight.

- **Recording instruments**

1. All users shall keep the recording instruments (disturbance recorder and event logger) in proper working condition.
2. The disturbance recorders shall have time synchronization and a standard format for recording analogue and digital signals which shall be included in the guidelines issued by the respective RPCs.
3. The time synchronization of the disturbance recorders shall be corroborated with the PMU data or SCADA event loggers by the respective RLDC. Disturbance recorders which are non-compliant shall be listed out for discussion at RPC.

## **Annexure – 5: Third Party Protection System Checking & Validation Template for a Substation (IEGC 2023 Annexure – 1)**

### **1. Introduction:**

- a. The audit reports, along with action plan for rectification of deficiencies found, if any, shall be submitted to RPC or RLDC within a month of submission of report by auditor.
- b. The third-party protection system checking shall be carried at site by the designated agency. The agency shall furnish two reports:
  - i. Preliminary Report: This report shall be prepared on the site and shall be signed by all the parties present.
  - ii. Detailed Report: This report shall be furnished by agency within one month after carrying out detailed analysis.

### **2. Checklist:**

- a. The protection system checklist shall contain information as per this Regulation.
  - i. General Information (to be provided prior to the checking as well as to be included in final report):
    - Substation name
    - Name of Owner Utility
    - Voltage Level (s) or highest voltage level
    - Short circuit current rating of all equipment (for all voltage level) (v) Date of commissioning of the substation
    - Checking and validation date
    - Record of previous tripping's (in last one year) and details of protection operation
    - Previous Relay Test Reports
    - Overall single line diagram (SLD) (x) AC aux SLD
    - DC aux SLD
    - SAS architecture diagram
    - SPS scheme implemented (if any)
  
- b. The preliminary report shall inter-alia contain the following:

## FORMAT OF PRELIMINARY REPORT

S. No.	Issues	Remarks
1	<b>Recommendation of last protection checking and validation</b>	Status of works & pending issues if any
2	<b>Review of existing settings at substation</b>	Recommended Action
3	<b>Disturbance Recorder out/ available for last 6 trippings (Y/N)</b>	Recommended Action
4	<b>Chronic reason of tripping, if any</b>	Recommended Action
5	<b>Major non-conformity/deficiency observed</b>	Recommended Action

c. The **relay configuration check-list** for available power system elements at station:

- Transmission Line
- Bus Reactor/Line Reactor
- Inter-connecting Transformer
- Busbar Protection Relay
- AC auxiliary system
- DC auxiliary system
- Communication system
- Circuit Breaker Details
- Current Transformer details
- Capacitive Voltage Transformers Details
- Any other equipment/system relevant for protection system operation

d. The **minimum set of points on which checking & validation** shall be carried out is covered in this clause. The detailed list shall be prepared by checking and validation team in consultation with concerned entity, RLDC and RPC.

**i. Transmission Line Distance Protection/Differential Protection;**

- Name and Length of Line
- Whether series compensated or not
- Mode of communication used (PLCC/OPGW)
- Relay Make and Model for Main-I and Main-II
- List of all active protections & settings

- Carrier aided scheme if any
- Status of Power Swing/Out of Step/SOTF/Breaker Failure/Broken Conductor/STUB/Fault Locator/DR/VT fuse fail/Overvoltage Protection/Trip Circuit supervision/Auto-reclose/Load encroachment etc.
- Relay connected to Trip Coil-1 or 2 or both i. CT ratio and PT ratio
- Feed from DC supply-1 or 2
- Connected to dedicated CT core (mention name)
- Other requirements for protection checking and validation

**ii. Shunt Reactor & Inter-connecting Transformer (ICT) Protection;**

- Whether two groups of protections used (Group A and Group B)
- Do the groups have separate DC sources
- Relay Make and Model
- List of all active protections along with settings
- Status of Differential Protection/Restricted Earth Fault Protection/Back-up Directional Overcurrent/Backup Earth fault/ Breaker Failure
- Status of Oil Temperature Indicator/Winding-Temperature Indicator/Bucholz/Pressure Release Device etc.
- Relay connected to Trip Coil-1 or 2 or both
- CT ratio and PT ratio
- Feed from DC supply-1 or 2
- Connected to dedicated CT core (mention name)
- Other requirements for protection checking and validation

**iii. Busbar Protection Relay;**

- Busbar and redundant relay make and model
- Type of Busbar arrangement
- Zones
- Dedicated CT core for each busbar protection (Yes/No)
- Breaker Failure relay included (Yes/No), if additional then furnish make and model
- Trip issued to both Busbar protection in case of enabling
- Isolator indication and check relays
- Other requirements for protection checking and validation

**iv. AC auxiliary system;**

- Source of AC auxiliary system
- Supply changeover between sources (Auto/Manual)
- Diesel generator (DG) details
- Maintenance plan and supply changeover periodicity in DG
- Single Line Diagram
- Other requirements for protection checking and validation

**v. DC auxiliary system;**

- Type of Batteries (Make, vintage, model)
- Status of battery Charger
- Measured voltage (positive to earth and negative to earth)
- Availability of ground fault detectors
- Protection relays and trip circuits with independent DC sources
- Other requirements for protection checking and validation
- Communication system
  - Mode of communication for Main-1 and Main-2 protection
  - Mode of communication for data and speech communication
  - Status of PLCC channels
  - Time synchronization equipment details
  - 7OPGW on geographically diversified paths for Main-1 and main-2 relay
  - Other requirements for protection checking and validation

**vi. Circuit Breaker Details;**

- Details and Status
- Healthiness of Tripping Coil and Trip circuit supervision relay
- Single Pole/Multi pole operation
- Pole Discrepancy Relay available (Y/N)
- Monitoring Devices for checking the dielectric medium
- Other requirements for protection checking and validation
- Current Transformer (CT)/Capacitive Voltage Transformer (CVT) Details
  - CT/CVT ID name and voltage level
  - CT/CVT core connection details
  - Accuracy Class

- Whether Protection/Metering
- CT/CVT ratio available and ratio adopted
- Details of last checking and validation of CT/CVT healthiness
- Other requirements for protection checking and validation
- Other protections: Direction earth fault, negative sequence, over current, over voltage, over frequency, under voltage, under frequency, forward power, reverse power, out of step/power swing, HVDC protection etc.

### 3. Summary of checking:

The summary shall specifically mention minimum following points:

- a) The settings and scheme adopted are in line with agreed protection philosophy or any accepted guidelines (e.g. Ramakrishna guidelines or CBIP manual based).
- b) The deviations from the RPC protection philosophy, if any and reasons for taking the deviations shall be recorded.
- c) All the major general deficiency shall be listed in detail along with remedial recommendations.
- d) The relay settings to be adopted shall be validated with simulation based or EMTP studies and details shall be enclosed in report.
- e) The cases of protection maloperation shall be analysed from protection indices report furnished by concerned utility, the causes of failure along with corrective actions and recommendations based on the findings shall be noted in the report.

## Annexure – 6: Protection Philosophy/Protocol of Northern Region

The Protection Philosophy/Protocol of Northern Region is developed in compliance of IEGC 2023, Version 2.0 which was approved in 71<sup>st</sup> NRPC meeting held on 29.01.2024.

S.N.	Protection Setting/Protocol	Mandated Setting for transmission lines
1	<b>Protection Scheme</b>	<p>220KV and above: Independent Main-I and Main-II protection (of different make OR different type/different algorithm) of non-switched numerical type is to be provided with carrier aided scheme.</p> <p>132KV and below: One non-switched distance protection scheme and, directional over current and earth fault relays, should be provided as back up.</p>
2	<b>Distance Protection Zone-1</b>	<p>Reach: 80% of the protected line; 110% of the protected line (In case of radial lines) Time Setting: Instantaneous.</p>
3	<b>Distance Protection Zone-2</b>	<p>Reach: Single Circuit Line: 120% of length of principle line section. Double circuit line: 150% coverage of line to take care of under reaching due to mutual coupling effect.</p> <p>Time setting: i. 0.35 second <i>(considering LBB time of 200mSec, CB open time of 60ms, resetting time of 30ms and safety margin of 60ms)</i> ii. 0.5-0.6 second <i>(For a long line followed by a short line)</i></p>



S.N.	Protection Setting/Protocol	Mandated Setting for transmission lines
4	<b>Distance Protection Zone-3</b>	Reach: Zone-3 should overreach the remote terminal of the longest adjacent line by an acceptable margin (typically 20% of highest impedance seen) for all fault conditions. Time Setting: 800-1000 msec If zone-3 reach transcends to other voltage level, time may be taken up to 1.5 sec.
5	<b>Distance Protection Zone- 4</b>	The Zone-4 reverse reach must adequately cover expected levels of apparent bus bar fault resistance. Time may be coordinated accordingly. Where Bus Bar protection is not available, time setting: 160 msec.
6	<b>Lines with Series and other compensations in the vicinity of Substation</b>	<ul style="list-style-type: none"> <li>• Zone-1:                FSC end: 60% of the protected line.                Time: Instantaneous;                Remoted end: 60% of the protected line with 100ms-time delay. POR Communication scheme logic is modified such that relay trips instantaneously in Zone-1 on carrier receive.</li> <li>• Zone-2:                120 % of uncompensated line impedance for single circuit line. For Double circuit line, settings may be decided on basis of dynamic study in view of zero sequence mutual coupling.</li> <li>• Phase locked voltage memory is used to cope with the voltage inversion. Alternatively, an intentional time delay may be applied to overcome directionality problems related to voltage inversion.</li> <li>• Over-voltage stage-I setting for series compensated double circuit lines may be kept higher at 113%.</li> </ul>

S.N.	Protection Setting/Protocol	Mandated Setting for transmission lines
7	<b>Power Swing Blocking</b>	<ul style="list-style-type: none"> <li>Block tripping in all zones, all lines.</li> </ul> Out of Step tripping to be applied on all inter-regional tie lines. Deblock time delay = 2s
8	<b>Protection for broken conductor</b>	Negative Sequence current to Positive Sequence current ratio more than 0.2 (i.e. $I_2/I_1 \geq 0.2$ ) Alarm Time delay: 3-20 sec. Tripping may be considered for radial lines to protect single phasing of transformers.
9	<b>Switch on to fault (SOTF)</b>	Switch on to fault (SOTF) function to be provided in distance relay to take care of line energization on fault.
10	<b>VT fuse fail detection function</b>	VT fuse fail detection function shall be correctly set to block the distance function operation on VT fuse failure.
11	<b>Carrier Protection</b>	To be applied on all 220KV and above lines with the only exception of radial feeders.
12	<b>Back up Protection</b>	<ol style="list-style-type: none"> <li>On 220KV and above lines with 2 Main Protections:               <ul style="list-style-type: none"> <li>Back up Earth Fault protections alone to be provided.</li> <li>No Over current protection to be applied.</li> </ul> </li> <li>At 132KV and below lines with only one Main protection:               <ul style="list-style-type: none"> <li>Back up protection by IDMT O/C and E/F to be applied.</li> </ul> </li> </ol>

S.N.	Protection Setting/Protocol	Mandated Setting for transmission lines
13	<b>Auto Reclosing with dead time.</b>	<p>AR shall be enabled for 220 KV and above lines for single pole trip and re-closing. Dead time = 1.0s. Reclaim time = 25.0s</p> <p>Auto-recloser shall be blocked for following:</p> <ul style="list-style-type: none"> <li>• Faults in cables</li> <li>• Breaker Fail Relay</li> <li>• Line Reactor Protections</li> <li>• O/V Protection</li> <li>• Received Direct Transfer trip signals</li> <li>• Busbar Protection</li> <li>• Zone 2/3 of Distance Protection</li> <li>• Circuit Breaker Problems.</li> </ul> <p>CB Pole discrepancy relay time:1.5 sec; for tie breaker: 2.5 sec</p>
14	<b>Busbar protection</b>	To be applied on all 220KV and above sub stations with the only exception of 220KV radial fed bus bars.
15	<b>Local Breaker Backup (LBB)</b>	<p>For 220 KV and above level substations as well as generating stations switchyards, LBB shall be provided for each circuit breaker.</p> <p>LBB Current sensor I &gt; 20% In LBB time delay = 200ms</p> <p>In case of variation in CT ratio, setting may be done accordingly.</p>
16	<b>Line Differential</b>	<p>For cables and composite lines, line differential protection with built in distance back up shall be applied as Main-I protection and distance relay as Main-II protection.</p> <p>For very short line (less than 10 km), line differential protection with distance protection as backup (built-</p>

S.N.	Protection Setting/Protocol	Mandated Setting for transmission lines
		<p>in Main relay or standalone) shall be provided mandatorily as Main-I and Main-II.</p> <p>Differential protection may be done using dark fiber (preferably), or using bandwidth.</p>
17	<b>Over Voltage Protection</b>	<p>FOR 765KV LINES/CABLE:  Low set stage (Stage-I): 106% - 109% (typically 108%) with a time delay of 5 seconds.  High set stage (Stage-II): 140% - 150% with a time delay of 100 milliseconds.</p> <p>400KV LINES/CABLE:  Low set stage (Stage-I): 110% - 112% (typically 110%) with a time delay of 5 seconds.  High set stage (Stage-II): 140% - 150% with a time delay of 100 milliseconds.</p> <p>FOR 220 KV LINES:  No over-voltage protection shall be used.</p> <p>FOR 220 KV CABLE:  Low set stage (Stage-I): 110% - 112% (typically 110%) with a time delay of 5 seconds.  High set stage (Stage-II): 140% - 150% with a time delay of 100 milliseconds.</p> <p>Drop-off to pick-up ratio of overvoltage relay:  better than 97%</p> <p>Grading: Voltage as well as time grading may be done for multi circuit lines/cable.</p>

S.N.	Protection Setting/Protocol	Mandated Setting for transmission lines
18	<b>Resistive reach setting to prevent load point encroachment</b>	<p>Following criteria may be considered for deciding load point encroachment:</p> <ul style="list-style-type: none"> <li>• Maximum load current (<math>I_{max}</math>) may be considered as 1.5 times the thermal rating of the line or 1.5 times the associated bay equipment current rating (the minimum of the bay equipment individual rating) whichever is lower. (Caution: The rating considered is approximately 15minutes rating of the transmission facility).</li> <li>• Minimum voltage (<math>V_{min}</math>) to be considered as 0.85pu (85%).</li> </ul>
19	<b>Direct Inter-trip</b>	<p>To be sent on operation of following:</p> <ol style="list-style-type: none"> <li>i. Overvoltage Protection</li> <li>ii. LBB Protection</li> <li>iii. Busbar Protection</li> <li>iv. Reactor Protection</li> <li>v. Manual Trip (400 KV and above)</li> <li>vi. Cable Fault (in composite lines)</li> </ol>
20	<b>Permissive Inter-trip</b>	To be sent on operation of Distance Protection

## Annexure – 7: Work Order & Corrigendum



पावर ट्रांसमिशन कारपोरेशन ऑफ उत्तराखण्ड लि०  
(उत्तराखण्ड सरकार का उपक्रम)  
अधीक्षण अभियन्ता (परीक्षण एवं परिचालन एवं स्काडा) कार्यालय  
कुमायु मण्डल हल्द्वानी  
मोबाइल नं० 9412089275, ईमेल dp\_singh@ptcul.org

No. 376 /SE (T&C)/PTCUL/ (H)/

Date:29.09.2023

Subject:- Order for Protection Audit of 02 Nos 400 kV and 08 Nos 220KV sub-stations in PTCUL.

Joint Advisor

Central Board of Irrigation and Power

Malcha Marg Chanakyapuri,

New Delhi-110021

Email: mrchauhan@cbip.org.

Dear Sir,

In reference to your offer submitted vide Ref No: P-1/CBIP/PTCUL/PTCUL/Audit/2023 dated: 11.09.2023 through email against Email enquiry dated 05.09.2023, an order is hereby placed in favour of your firm for the work of "Protection Audit of 02 Nos 400kV and 08 Nos 220 kV substations of PTCUL" The detail of material, price schedule and terms & conditions is here as under:-

Sr.No	Description	Unit	Qty	Amount	Total Amount
1	Protection Audit to be carried out for the following 10 nos of the 400/220kV substations of PTCUL :- 1. 400kV S/s Rishikesh 2. 400 kV S/s Kashipur 3. 220kV S/s Chamba 4. 220kV S/s Rishikesh 5. 220kV S/s Roorkee 6. 220kV S/s Haridwar (SIDCUL) 7. 220kV S/s Jhajra. 8. 220 kV S/s Pantnagar. 9. 220 kV S/s Haldwani. 10. 220kV S/s Mahuakheraganj.	Job	1	36,25,000	36,25,000
	<b>TOTAL</b>				36,25,000

Total value of order is Rs.36,25,000 (Rupees Thirty Six Lakh Twenty Five Thousand only ) Plus GST Extra.

End: 1. Terms & Conditions.

Please acknowledge the receipt and acceptance of order.

(D.P Singh)

Superintending Engineer (T&C), Haldwani

Date:29.09.2023

No.376 /SE (T&C)/PTCUL/ (H)/

Copy forwarded to the following for information and necessary action:-

1. Director (Operation), PTCUL, Dehradun.
2. Superintending Engineer (A) MD, PTCUL, Dehradun.
3. Chief Engineer, T&C PTCUL, 132kV Substation Campus, Kathgodam Nainital.
4. Executive Engineer, T&C Division, Kashipur.
5. Director (Energy), Central Board of Irrigation and Power Malcha Marg Chanakyapuri, New Delhi-110021 Email: [sanjeev@cbip.org](mailto:sanjeev@cbip.org)

(D.P Singh)

Superintending Engineer (T&C), Haldwani

मुख्यालय एवंपंजीकृत कार्यालय:-विद्युतमवन, नजदीक-आई०एस०बी०टी० क्रॉसिंग, सहारनपुररोड, गाजरा, देहरादून-248002  
कारपोरेटआईडी नं०: U40101UR2004GOI028675 दरमाश नं० 0135-2646000 फ़ैक्स नं० 0135-2643460 वेबसाइट [www.ptcul.org](http://www.ptcul.org)



पावर ट्रांसमिशन कारपोरेशन ऑफ उत्तराखण्ड लि0  
(उत्तराखण्ड सरकार का उपक्रम)  
अधीक्षण अभियन्ता (परीक्षण एवं परिचालन एवं स्काडा) कार्यालय  
कुमायु मण्डल हल्द्वानी  
मोबाइल नं0 9412089275, ईमेल dp\_singh@ptcul.org

Terms & Conditions:-

1	Scope	<p>: The detailed Scope work is as under:</p> <ol style="list-style-type: none"><li>1. There must be a kick off meeting for discussion on project plan before start of the work in field and the detailed plan of performance shall be submitted by CBIP.</li><li>2. Requisite data shall be collected in standard format from PTCUL grid substations by authorized and experienced auditor.</li><li>3. The site surveys and audit of grid substations of PTCUL shall be done by authorized and experienced auditor.</li><li>4. Review of the implemented protection schemes/philosophy for 400/220 kV substations which includes protection of transmission lines,interconnecting transformers, line/busreactors, bus bar, bus couplers etc.as per latest guidelines of Ramakrishna committee/CBIP/NRPC/Intenational best practices.etc.</li><li>5. Review the adequacy of primary and backup protection settings for protected equipment and suggest corrective measures where evernon compliance with respect to Ramakrishna committee/ CBIP/NRPC is found during the protection audit.</li><li>6. Review of availability/healthiness of PLCC communication links used for protection systems.</li><li>7. Review the healthiness/adequacy of 220/110/50V DC system available at substations for protection application.</li><li>8. Review of availability/healthiness of GPS system and time synchronization facility used for protection.</li><li>9. Review of availability/healthiness of recording instruments like DRs /ELs for transmission lines protection.</li><li>10. Review of test reports for assessing the healthiness of circuit breakers, CT &amp; CVT based upon available test reports at sites.</li><li>11. Field inspection of protection device for obsolescence of technology, suitability and healthiness.</li><li>12. Directory of the protection system &amp; recommendation for replacement of obsolescence relays with compatible numerical relays will be provided.</li><li>13. Checking of availability of DGset/auxiliary DC supply at substations.</li><li>14. Site visits for onsite protection audit, review and inspection of substations will be performed.</li><li>15. Submission of the detailed report for the protection audit including the protection philosophy, reviewed settings and protection audit observations.</li><li>16. The performance of above protection equipment like relays, circuit breaker, CT, CVT, DC battery bank, synchro facility, communication facility used for protection will be also checked through physical inspection and provided test reports/documents. These protection equipments will be recommended for renovation and upgradation based on their performance accessed during protection audit and physical inspection.</li><li>17. Review the availability healthiness of<ul style="list-style-type: none"><li>• Event recorders/ loggers' operation history</li><li>• CT, CVT, CB</li><li>• DC power supply</li><li>• Auxiliary supply</li><li>• Communication links</li><li>• Time synchronization/ GPS</li></ul></li><li>18. Review of Testing and Maintenance records of all protective relays, Circuit Breakers CT, CVT etc. Review of protection philosophy.</li></ol>
---	-------	--

मुख्यालय एवंपञ्जीकृत कार्यालय:-विद्युतमवन, नजदीक-आई0एस0बी0टी0 क्रासिंग, सहारनपुररोड, माजरा, देहरादून-248002  
कारपोरेटआईडी नं0: U40101UR2004GOI028675 दूरभाष नं0 0135-2646000 फैक्स नं0 0135-2643460 वेबसाइटwww.ptcul.org





पावर ट्रांसमिशन कारपोरेशन ऑफ उत्तराखण्ड लि०  
(उत्तराखण्ड सरकार का उपक्रम)  
अधीक्षण अभियन्ता (परीक्षण एवं परिचालन एवं स्काडा) कार्यालय  
कुमायु मण्डल हल्द्वानी  
मोबाइल नं० 9412089275, ईमेल dp\_singh@ptcul.org

			19. Anything which is left to be mentioned here but required for successful completion of the aforementioned subject work shall be done <b>Central Board of Irrigation and Power Malcha Marg Chanakyapuri, New Delhi-110021</b> 20. CBIP Delhi shall submit a report on detailed points in four sets of hard copy duly spiraled binding as well as soft copy shall be submitted. 21. The safety guidelines prevalent in PTCUL must be followed.
2	GST	:	GST shall be paid extra as per applicable Government rules.
3	Tax	:	Tax shall be deducted at source as per applicable Government rules. A certificate to this effect may be given to the Contractor if required.
4	Date of Start of work	:	Order shall be considered as having come in to force from the date of issue of order.
5	Supply Completion	:	NA
6	Work completion	:	The work should be completed within 24 months from the date of issue of order.
7	Engineer of the contract		Superintending Engineer (T&C), Haldwani is the "Engineer of the contract" who shall be placing the order for the work with the contractor and signing the contract agreement and who has been inherently vested with such powers by corporation in this behalf and shall act as Engineer for the purpose of the contract.
8	Engineer in-charge		<b>Respective Executive Engineer (T&amp;C) shall be "Engineer in charge"</b> for the subject work.
9	Liquidity damages	:	If the contract is delayed beyond the stipulated period mentioned in the contract. The liquidity damages shall be levied @ 0.5 % per week and maximum up to 10% of contract value.
10	Dispute		All Dispute arising out of this case under the jurisdiction local court at Kashipur and Honable High Court, Nainital.
11	Payment terms	:	1. 25% Payment will be made within 30 days after finalization of Audit plan, subject to availability of funds from PTCUL HQ. 2. 35% Payment will be made within 30 days after submission of preliminary reports verified by Executive Engineer of respective division, subject to availability of funds from PTCUL HQ. 3. 40 % Payment will be made within 30 days after submission of final reports verified by Executive Engineer of respective division, subject to availability of funds from PTCUL HQ.
12	Payement unit		Test & Commissioning Division, Kashipur shall be the payment unit and all units where is to be work done shall record the measurement and duly passed bills along with measurement book shall be submitted to payment unit.
13	Warranty period	:	NA.
14	Billing Address	:	Executive Engineer Test & Commissioning Division, PTCUL 400 KV Substation Campus, Kashipur (Uttarakhand)-244713, GSTIN No. I05AAECM1785FC29)

All other term and condition of this order shall be governed by the General conditions of the contract prevalent in PTCUL.

  
(D.P Singh)

Superintending Engineer(T&C), Haldwani

मुख्यालय एवंपंजीकृत कार्यालय:-विद्युतमवन, नजदीक-आई०एस०बी०टी० क्रासिंग, सहारनपुररोड, माजरा, देहरादून-248002  
कारपोरेटआईडी नं०: U40101UR2004GOI028675 दूरभाष नं० 0135-2646000 फैंक्स नं० 0135-2643460 वेबसाइटwww.ptcul.org





पावर ट्रांसमिशन कारपोरेशन ऑफ उत्तराखण्ड लि०  
(उत्तराखण्ड सरकार का उपक्रम)  
अधीक्षण अभियन्ता (परीक्षण एवं परिचालन एवं स्काडा) कार्यालय  
कुमायु मण्डल हल्द्वानी  
मोबाइल नं० 9412089275, ईमेल dp\_singh@ptcul.org

No. 394 /SE (T&C)/PTCUL/ (H)/

Date:26.10.2023

Subject:- Corrigendum for the Order for the work of Protection Audit of 02 Nos 400 kV and 08 Nos 220KV sub-stations in

PTCUL

Joint Advisor

Central Board of Irrigation and Power

Malcha Marg Chanakyapuri,

New Delhi-110021

Email: mrchauhan@cbip.org.

Dear Sir,

In reference to above mentioned subject, please refer to kick off meeting held on dated 26.10.2023 for the work of Protection Audit of 02 Nos 400 kV and 08 Nos 220KV sub-stations in PTCUL against order no.376 dated 29.09.2023.

In this regard, kindly find enclosed herewith corrigendum of order no.376 dated 29.09.2023 (Annexure-1) with necessary amendments as discussed in aforementioned meeting.

This is for your kind information and necessary action.

Please acknowledge the receipt and acceptance of order.

(D.P Singh)

Superintending Engineer (T&C), Haldwani

Copy forwarded to the following for information and necessary action:-

1. Chief Engineer, T&C PTCUL, 132KV Substation Campus, Kathgodam Nainital.
2. Executive Engineer, T&C Division, Roorkee/Dehradun/Haldwani/Kashipur/Rishikesh with request to provide assistance and information to CBIP for the above work.
3. Director (Energy), Central Board of Irrigation and Power Malcha Marg Chanakyapuri, New Delhi-110021  
Email: [sanjeev@cbip.org](mailto:sanjeev@cbip.org)

मुख्यालय एवंपंजीकृत कार्यालय:-विद्युतमवन, नजदीक-आई०एस०बी०टी० क्रासिंग, सहारनपुररोड़, माजरा, देहरादून-248002  
कारपोरेटआईडी नं०: U40101UR2004GOI028675 दूरभाष नं० 0135-2646000 फैंक्स नं० 0135-2643460 वेबसाइटwww.ptcul.org

**Annexure -1 – Work order corrigendum**

**Scope:** The detailed Scope work is as under:

S. No.	Clause of PO	Existing Clause					Modified Clause						
		Sr. No	Description	Unit	Qty	Amount	Total Amount	Sr. No	Description	Unit	Qty	Unit rate (Rs.)	Total Amount (Rs.)
1	Price Schedule	1	Protection Audit to be carried out for the following 10 nos. of the 400/220kV substations of PTCUL :- 1. 400kV S/s Rishikesh 2. 400 kV S/s Kashipur 3. 220kV S/s Chamba 4. 220kV S/s Rishikesh 5. 220kV S/s Roorkee 6. 220kV S/s Haridwar (SIDCUL) 7. 220kV S/s Jhajra. 8. 220 kV S/s Pantnagar. 9. 220 kV S/s Haldwani. 10. 220kV S/s Mahuakheragan]. TOTAL	Job	1	36,25,000	36,25,000	1	Protection Audit to be carried out for the following 10 nos of the 400/220kV substations of PTCUL:- 1. 400kV S/s Rishikesh 2. 400 kV S/s Kashipur 3. 220kV S/s Chamba 4. 220kV S/s Rishikesh 5. 220kV S/s Roorkee 6. 220kV S/s Haridwar (SIDCUL) 7. 220kV S/s Jhajra 8. 220 kV S/s Pantnagar 9. 220 kV S/s Haldwani 10. 220kV S/s Mahuakheragan] TOTAL	Each	10	3,62,500	36,25,000
2	Terms and Conditions - 5. No. 1 – Scope	<ol style="list-style-type: none"> <li>There must be a kick off meeting for discussion on project plan before start of the work in field and the detailed plan of performance shall be submitted by CBIP.</li> <li>Requisite data shall be collected in standard format from PTCUL grid substations by authorized and experienced auditor.</li> <li>The site surveys and audit of grid substations of PTCUL shall be done by authorized and experienced auditor.</li> <li>Review of the implemented protection schemes/ philosophy for 400/220 kV substations which includes protection of transmission lines, interconnecting transformers, line/bus reactors, bus bar, bus couplers etc. with respect to</li> </ol>					<ol style="list-style-type: none"> <li>There must be a kick off meeting for discussion on project plan before start of the work in field and the detailed plan of performance shall be submitted by CBIP.</li> <li>Requisite data shall be collected in standard format from PTCUL grid substations by an experienced auditor.</li> <li>The site surveys and audit of grid substations of PTCUL shall be done by an experienced auditor.</li> <li>Review of the implemented protection schemes/philosophy for 400/220 kV substations which includes protection of transmission lines, interconnecting transformers, line/bus reactors, bus bar, bus couplers etc. with respect to</li> </ol>						



5. Clause of PO	Existing Clause	Modified Clause
	<p>couplers etc.as per latest guidelines of Ramakrishna committee/ CBIP/NRPC/International best practices. etc.</p> <p>5. Review the adequacy of primary and backup protection settings for protected equipment and suggest corrective measures where everyone compliance with respect to Ramakrishna committee/ CBIP/NRPC is found during the protection audit.</p> <p>6. Review of availability/healthiness of PLCC communication links used for protection systems.</p> <p>7. Review the healthiness/adequacy of 220/110/50V DC system available at substations for protection application.</p> <p>8. Review of availability/healthiness of GPS system and time synchronization facility used for protection.</p> <p>9. Review of availability/healthiness of recording instruments like DRs /ELs for transmission lines protection.</p> <p>10. Review of test reports for assessing the healthiness of circuit breakers, CT &amp; CVT based upon available test reports at sites.</p> <p>11. Field inspection of protection device for obsolescence of technology, suitability and healthiness.</p> <p>12. Directory of the protection system &amp; recommendation for replacement of obsolescence relays with compatible numerical relays will be provided.</p> <p>13. Checking of availability of DG Set/auxiliary DC supply at substations.</p> <p>14. Site visits for onsite protection audit, review and inspection of substations will be performed.</p> <p>15. Submission of the detailed report for the protection audit including the protection philosophy, reviewed settings and protection audit observations.</p> <p>16. The performance of above protection equipment like relays, circuit breaker, CT, CVT, DC battery bank, synchro facility, communication facility used for protection will be also checked through physical inspection and provided test reports/documents. These protection equipment's will be recommended for renovation and upgradation based on their performance accessed during protection audit and physical inspection.</p>	<p>tripping in last one year as per latest guidelines of Ramakrishna committee/ CBIP/NRPC/International best practices, which includes review of the following:</p> <p>a) Adequacy of primary and backup protection settings for protected equipment and suggest corrective measures</p> <p>b) Availability/healthiness of PLCC communication links used for protection systems.</p> <p>c) Healthiness/adequacy of 220/110/50V DC system available at substations for protection application.</p> <p>d) Availability/healthiness of GPS system and time synchronization facility used for protection.</p> <p>e) Availability/healthiness of recording instruments like DRs /ELs for transmission lines protection.</p> <p>f) Test reports for assessing the healthiness of circuit breakers, CT &amp; CVT based upon available test reports at sites.</p> <p>g) Field inspection of protection device for obsolescence of technology, suitability and healthiness.</p> <p>h) Prepare recommendation for replacement of obsolescence relays with compatible numerical relays will be provided.</p> <p>i) Checking of availability of DG Set / auxiliary DC supply at substations.</p> <p>5. Site visits for onsite protection audit, review and inspection of substations will be performed</p> <p>6. Submission of the detailed report for the protection audit including the protection philosophy, reviewed settings and protection audit observations.</p> <p>Deleted as it is covered in point 4 above.</p>





S. No.	Clause of PO	Existing Clause	Modified Clause
		<p>17. Review the availability healthiness of</p> <ul style="list-style-type: none"> <li>• Event recorders/ loggers' operation history</li> <li>• CT, CVT, CB</li> <li>• DC power supply</li> <li>• Auxiliary supply</li> <li>• Communication links</li> <li>• Time synchronization/ GPS</li> </ul> <p>18. Review of Testing and Maintenance records of all protective relays, Circuit Breakers CT, CVT etc. Review of protection philosophy.</p> <p>19. Anything which is left to be mentioned here but required for successful completion of the aforementioned subject work shall be done Central Board of Irrigation and Power Malcha Marg Chanakyapuri, New Delhi-110021</p> <p>20. CBIP Delhi shall submit a report on detailed points in four sets of hard copy duly spiraled binding as well as soft copy shall be submitted.</p> <p>21. The safety guidelines prevalent in PTCUL must be followed.</p>	<p>7. Anything which is left to be mentioned here but required for successful completion of the aforementioned subject work shall be done by Central Board of Irrigation and Power.</p> <p>8. CBIP Delhi shall submit a protection report on detailed points in four sets of hard copy duly spiraled binding and in soft copy as well.</p> <p>9. The safety guidelines prevalent in PTCUL must be followed.</p>
3	Terms and Conditions - S. No. 6 - Work Completion	The work should be completed within 24 months from the date of issue of order	The work should be completed within 24 weeks from the date of issue of corrigendum.
4	Terms and Conditions - S. No. 8 - Engineer- in-charge	Respective Executive Engineer (T&C) shall be "Engineer in charge" for the subject work.	<p>The following Executive Engineers (T&amp;C) shall be "Engineer in charge" for the subject work:</p> <p>a) 400KV Rishikesh, 220KV Rishikesh, 220 KV Chamba – Mr. Harsh Verma (Ph. No.9412074038 &amp; Email: ee_tandc_rsh@ptcul.org).</p> <p>b) 400KV Kashipur, 220KV Pantnagar, 220KV Haldwani &amp; 220KV MahuaKherapanj – Mr. Asim Baig (Ph. No. 9412087885 &amp; Email: ee_tandc_ksp@ptcul.org).</p> <p>c) 220KV SIDCUL Haridwar, 220 KV Roorkee – Mr. Ashwini Kumar (Ph. No.7088117301 &amp; Email: ee_tandc_ks@ptcul.org).</p> <p>d) 220KV Jhajra – Mr. Ravindra Kumar (Ph. No. 9927744222 &amp; Email: ee_tandc_ddum@ptcul.org).</p>

4







S. No.	Clause of PO	Existing Clause	Modified Clause
5	Terms and Conditions - S. No. 11 - Payment Terms	<ol style="list-style-type: none"> <li>25% Payment will be made within 30 days after finalization of Audit plan, subject to availability of funds from PTCUL HQ.</li> <li>35% Payment will be made within 30 days after submission of preliminary reports verified by Executive Engineer of respective division, subject to availability of funds from PTCUL HQ.</li> <li>40 % Payment will be made within 30 days after submission of final reports verified by Executive Engineer of respective division, subject to availability of funds from PTCUL HQ.</li> </ol>	<ol style="list-style-type: none"> <li>25% Payment will be made within 30 days after finalization of Audit plan, subject to availability of funds from PTCUL HQ.</li> <li>35% Payment will be made within 30 days after submission of preliminary reports <b>on prorata basis</b> verified by Executive Engineer of respective division, subject to availability of funds from PTCUL HQ.</li> <li>40 % Payment will be made within 30 days after submission of final reports <b>on prorata basis</b> verified by Executive Engineer of respective division, subject to availability of funds from PTCUL HQ.</li> <li>The local travel, lodging &amp; boarding shall be arranged by PTCUL on free-of-cost basis for CBIP team visiting the substation</li> </ol>







## **Annexure – 8: Data Sheets**

# Contents

<b>Single Line Diagrams</b> .....	52
<i>Substation Single Line Diagram</i> .....	52
<i>AC Auxiliary System</i> .....	53
<i>DC Auxiliary System</i> .....	54
<b>Transmission Lines</b> .....	55
<b>AC Auxiliary System</b> .....	58
<b>DC Auxiliary System</b> .....	59
<b>Circuit Breakers</b> .....	60
<b>Current Transformer</b> .....	64
<b>Capacitive Voltage Transformer/Potential Transformer</b> .....	72
<b>Communication System</b> .....	75
<b>Transformer Protection</b> .....	76
<b>Network Diagram of Uttarakhand</b> .....	81
<b>Power Map of Uttarakhand</b> .....	82

# Protection Audit of 220/132/33kV Pantnagar Substation

## Annexure - 8

### Data Sheets

## Single Line Diagrams

### Substation Single Line Diagram

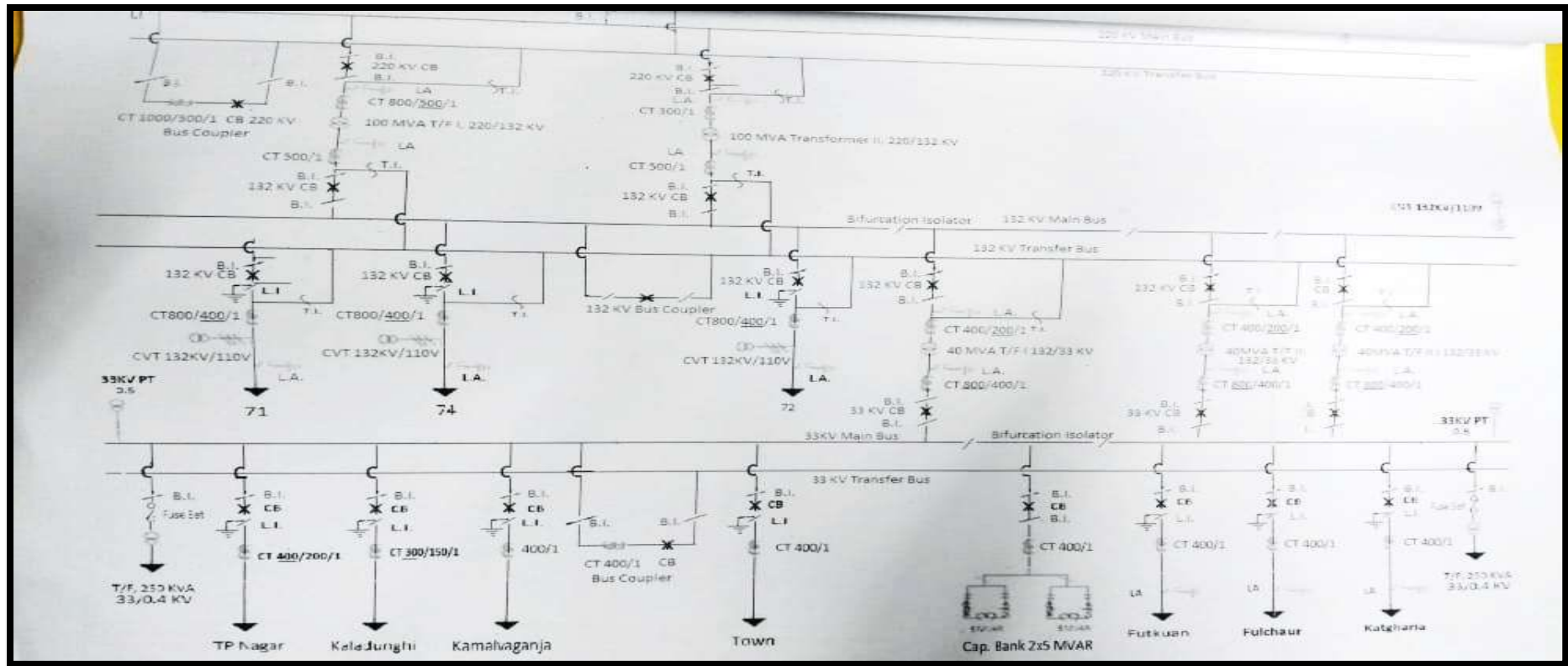



# AC Auxiliary System

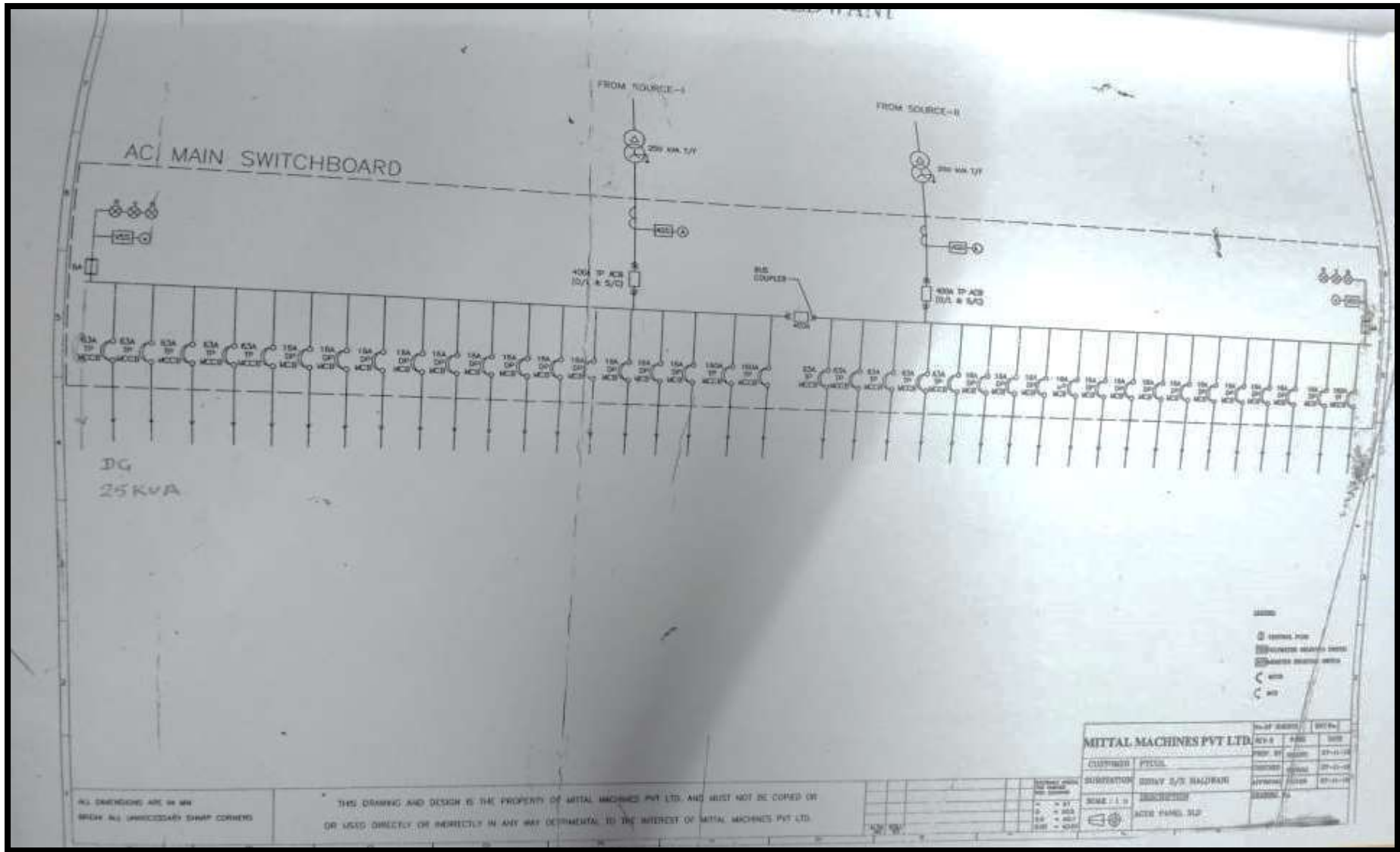

*DC Auxiliary System*

**Not Available**

## Transmission Lines

SL. No.	Particulars	Details
<b>a</b>	Name and Length of Line	220KV Pantnagar Line, 37.3Km
<b>b</b>	Whether series compensated or not	No
<b>c</b>	Mode of communication used (PLCC/ OPGW)	OPGW
<b>d</b>	Relay Make and Model for Main-I and Main-II	Seimens Siprotec 7SA522, 7SJ621
<b>e</b>	List of all active protections & settings	Enclosed
<b>f</b>	Carrier aided scheme, if any	Carrier Inter-tripping
<b>g</b>	Status of Power Swing/ Out of Step/ SOTF/ Breaker Failure/ Broken Conductor/ STUB/ Fault Locator/ Disturbance Recorder/ VT fuse fail/ Overvoltage Protection/ Trip Circuit supervision/ Auto-reclose/ Load encroachment etc.	SOTF/ Broken Conductor / Fault Locator/ Disturbance Recorder/ VT fuse fail/ Trip Circuit supervision/ Auto-reclose Active
<b>h</b>	Relay connected to Trip Coil-1 or 2 or both	Both
<b>i</b>	CT ratio and PT ratio	800/1, 220KV/ 110V
<b>j</b>	Feed from DC supply-1 or 2	DC-1
<b>k</b>	Connected to dedicated CT core (mention name)	Core- 1 (Prot-1), 2-(B/U), 3-(Metering)
<b>l</b>	Other requirements for protection checking and validation	NA

<b>SL. No.</b>	<b>Particulars</b>	<b>Details</b>
<b>a</b>	Name and Length of Line	132KV Bazpur Line, 35.5Km
<b>b</b>	Whether series compensated or not	No
<b>c</b>	Mode of communication used (PLCC/ OPGW)	NA
<b>d</b>	Relay Make and Model for Main-I and Main-II	Seimens Siprotec 7SA522, 7SJ621
<b>e</b>	List of all active protections & settings	Enclosed
<b>f</b>	Carrier aided scheme, if any	NA
<b>g</b>	Status of Power Swing/ Out of Step/ SOTF/ Breaker Failure/ Broken Conductor/ STUB/ Fault Locator/ Disturbance Recorder/ VT fuse fail/ Overvoltage Protection/ Trip Circuit supervision/ Auto-reclose/ Load encroachment etc.	SOTF/ Broken Conductor / Fault Locator/ Disturbance Recorder/ VT fuse fail/ Trip Circuit supervision/ Auto-reclose Active
<b>h</b>	Relay connected to Trip Coil-1 or 2 or both	Both
<b>i</b>	CT ratio and PT ratio	800/1, 132KV/ 110V
<b>j</b>	Feed from DC supply-1 or 2	DC-1
<b>k</b>	Connected to dedicated CT core (mention name)	Core- 1 (Prot-1), 2-(B/U), 3-(Metering)
<b>l</b>	Other requirements for protection checking and validation	NA

<b>SL. No.</b>	<b>Particulars</b>	<b>Details</b>
<b>a</b>	Name and Length of Line	132KV Kathgodam Line, 8.4Km
<b>b</b>	Whether series compensated or not	No
<b>c</b>	Mode of communication used (PLCC/ OPGW)	NA
<b>d</b>	Relay Make and Model for Main-I and Main-II	Seimens Siprotec 7SA522, Schneider P143
<b>e</b>	List of all active protections & settings	Enclosed
<b>f</b>	Carrier aided scheme, if any	NA
<b>g</b>	Status of Power Swing/ Out of Step/ SOTF/ Breaker Failure/ Broken Conductor/ STUB/ Fault Locator/ Disturbance Recorder/ VT fuse fail/ Overvoltage Protection/ Trip Circuit supervision/ Auto-reclose/ Load encroachment etc.	SOTF/ Broken Conductor / Fault Locator/ Disturbance Recorder/ VT fuse fail/ Trip Circuit supervision/ Auto-reclose Active
<b>h</b>	Relay connected to Trip Coil-1 or 2 or both	Both
<b>i</b>	CT ratio and PT ratio	800/1, 220KV/ 110V
<b>j</b>	Feed from DC supply-1 or 2	DC-1
<b>k</b>	Connected to dedicated CT core (mention name)	Core- 1 (Prot-1), 2-(B/U), 3-(Metering)
<b>l</b>	Other requirements for protection checking and validation	NA

## AC Auxiliary System

SL. No.	Equipment	AC auxiliary system
a	Source of AC auxiliary system	2X250KVA S/S Transformer
b	Supply changeover between sources (Auto/Manual	Auto
c	Diesel generator (DG) details	25KVA, Make- Gentec, Model-GP-25TAW
d	Maintenance plan and supply changeover periodicity in DG	NA
e	Single Line Diagram	Enclosed
f	Other requirements for protection checking and validation	NA

## DC Auxiliary System

SL. No.	Equipment	DC auxiliary system
a	Type of Batteries (Make, voltage, model)	1- HBL VRLA/110V/TRIUMPH-HP2VF 300PP 2- Exide VRLA/110V / UPST12V 300AH
b	Status of battery Charger	Healthy
c	Measured voltage (positive to earth and negative to earth)	(+Ve to E) 58.4 V; (-Ve to E) 60.5 V
d	Availability of ground fault detectors	Available
e	Protection relays and trip circuits with independent DC sources	Available
f	Other requirements for protection checking and validation	NA

## Circuit Breakers

<b>220KV Pantnagar Line, 37.3km</b>		
<b>SL. No.</b>	<b>Equipment</b>	<b>Circuit Breaker</b>
<b>a</b>	Details and Status	Make-CGL, Sf6, 200-SFM-50AA
<b>b</b>	Healthiness of Tripping Coil and Trip circuit supervision relay	Healthy
<b>c</b>	Single Pole/ Multi pole operation	Single Pole
<b>d</b>	Pole Discrepancy Relay available (Y/ N)	YES
<b>e</b>	Monitoring Devices for checking the dielectric medium	NA
<b>f</b>	Other requirements for protection checking and validation	NA

<b>132KV Bazpur Line, 35.5km</b>		
<b>SL. No.</b>	<b>Equipment</b>	<b>Circuit Breaker</b>
<b>a</b>	Details and Status	Make-CGL, Sf6, 120-SFM-32B
<b>b</b>	Healthiness of Tripping Coil and Trip circuit supervision relay	Healthy
<b>c</b>	Single Pole/ Multi pole operation	Multi Pole
<b>d</b>	Pole Discrepancy Relay available (Y/ N)	YES
<b>e</b>	Monitoring Devices for checking the dielectric medium	NA
<b>f</b>	Other requirements for protection checking and validation	NA



<b>132KV Kathgodam Line, 8.4km</b>		
<b>S. No.</b>	<b>Equipment</b>	<b>Circuit Breaker</b>
<b>a</b>	Details and Status	Make-CGL, Sf6, 120-SFM-32B
<b>b</b>	Healthiness of Tripping Coil and Trip circuit supervision relay	Healthy
<b>c</b>	Single Pole/ Multi pole operation	Multi Pole
<b>d</b>	Pole Discrepancy Relay available (Y/ N)	YES
<b>e</b>	Monitoring Devices for checking the dielectric medium	NA
<b>f</b>	Other requirements for protection checking and validation	NA

<b>100MVA T/F - I</b>		
<b>S. No.</b>	<b>Equipment</b>	<b>Circuit Breaker</b>
<b>a</b>	Details and Status	(HV) Make-CGL, Sf6, 200-SFM-50AA (LV) Make-CGL, Sf6, 120-SFM-32B
<b>b</b>	Healthiness of Tripping Coil and Trip circuit supervision relay	Healthy
<b>c</b>	Single Pole/ Multi pole operation	(HV) Single Pole (LV) Multi Pole
<b>d</b>	Pole Discrepancy Relay available (Y/ N)	(HV) YES (LV) NA
<b>e</b>	Monitoring Devices for checking the dielectric medium	NA
<b>f</b>	Other requirements for protection checking and validation	NA

<b>100MVA T/F-II</b>		
<b>S. No.</b>	<b>Equipment</b>	<b>Circuit Breaker</b>
<b>a</b>	Details and Status	(HV) Make-CGL, Sf6, 200-SFM-50AA (LV) Make-CGL, Sf6, 120-SFM-32B
<b>b</b>	Healthiness of Tripping Coil and Trip circuit supervision relay	Healthy
<b>c</b>	Single Pole/ Multi pole operation	(HV) Single Pole (LV) Multi Pole
<b>d</b>	Pole Discrepancy Relay available (Y/ N)	(HV) YES (LV) NA
<b>e</b>	Monitoring Devices for checking the dielectric medium	NA
<b>f</b>	Other requirements for protection checking and validation	NA

<b>40MVA T/F-I</b>		
<b>S. No.</b>	<b>Equipment</b>	<b>Circuit Breaker</b>
<b>a</b>	Details and Status	Make-CGL, Sf6, 120-SFM-32B
<b>b</b>	Healthiness of Tripping Coil and Trip circuit supervision relay	Healthy
<b>c</b>	Single Pole/ Multi pole operation	Multi pole operation
<b>d</b>	Pole Discrepancy Relay available (Y/ N)	YES
<b>e</b>	Monitoring Devices for checking the dielectric medium	NA
<b>f</b>	Other requirements for protection checking and validation	NA

<b>40MVA T/F-II</b>		
<b>S. No.</b>	<b>Equipment</b>	<b>Circuit Breaker</b>
<b>a</b>	Details and Status	Make-CGL, Sf6, 120-SFM-32B
<b>b</b>	Healthiness of Tripping Coil and Trip circuit supervision relay	Healthy
<b>c</b>	Single Pole/ Multi pole operation	Multi pole operation
<b>d</b>	Pole Discrepancy Relay available (Y/ N)	YES
<b>e</b>	Monitoring Devices for checking the dielectric medium	NA
<b>f</b>	Other requirements for protection checking and validation	NA

<b>40MVA T/F-III</b>		
<b>S. No.</b>	<b>Equipment</b>	<b>Circuit Breaker</b>
<b>a</b>	Details and Status	Make-CGL, Sf6, 120-SFM-40AA
<b>b</b>	Healthiness of Tripping Coil and Trip circuit supervision relay	Healthy
<b>c</b>	Single Pole/ Multi pole operation	Multi pole operation
<b>d</b>	Pole Discrepancy Relay available (Y/ N)	YES
<b>e</b>	Monitoring Devices for checking the dielectric medium	NA
<b>f</b>	Other requirements for protection checking and validation	NA

## Current Transformer

220KV Pantnagar Line, 37.3km		
SL. No.	Equipment	Current Transformer
a	CT ID name and voltage level	Heptacare Power Industries
b	CT core connection details	5 Core, Core-1 (Prot-1), 2 (B/U), 3 (Metering)
c	Accuracy Class	PS, PS, 0.2, PS, PS
d	Whether Protection/ Metering	Both
e	CT ratio available and ratio adopted	1600/800/1, 800/1
f	Details of last checking and validation of CT healthiness	05.11.2023 at Routine Testing
g	Other requirements for protection checking and validation	NA
h	Other protection: Direction earth fault, negative sequence, over current, over voltage, over frequency, under voltage, under frequency, forward power, reverse power, out of step/ power swing, HVDC protection etc.	Direction earth fault, over current

<b>132KV Bazpur Line, 35.5km</b>		
<b>SL. No.</b>	<b>Equipment</b>	<b>Current Transformer</b>
<b>a</b>	CT ID name and voltage level	Heptacare Power Industries
<b>b</b>	CT core connection details	5 Core, Core-1 (Prot-1), 2 (B/U), 3 (Metering)
<b>c</b>	Accuracy Class	PS, PS, 0.2, PS, PS
<b>d</b>	Whether Protection/ Metering	Both
<b>e</b>	CT ratio available and ratio adopted	1600/800/1, 800/1
<b>f</b>	Details of last checking and validation of CT healthiness	02.10.2023 at Routine Testing
<b>g</b>	Other requirements for protection checking and validation	NA
<b>h</b>	Other protection: Direction earth fault, negative sequence, over current, over voltage, over frequency, under voltage, under frequency, forward power, reverse power, out of step/ power swing, HVDC protection etc.	Direction earth fault, over current

<b>132KV Kathgodam Line, 8.4km</b>		
<b>SL. No.</b>	<b>Equipment</b>	<b>Current Transformer</b>
<b>a</b>	CT ID name and voltage level	Heptacare Power Industries
<b>b</b>	CT core connection details	5 Core, Core-1 (Prot-1), 2 (B/U), 3 (Metering)
<b>c</b>	Accuracy Class	PS, PS, 0.2, PS, PS
<b>d</b>	Whether Protection/ Metering	Both
<b>e</b>	CT ratio available and ratio adopted	1600/800/1, 800/1
<b>f</b>	Details of last checking and validation of CT healthiness	07.08.2023 at Routine Testing
<b>g</b>	Other requirements for protection checking and validation	NA
<b>h</b>	Other protection: Direction earth fault, negative sequence, over current, over voltage, over frequency, under voltage, under frequency, forward power, reverse power, out of step/ power swing, HVDC protection etc.	Direction earth fault, over current

<b>100MVA T/F-I</b>		
<b>SL. No.</b>	<b>Equipment</b>	<b>Current Transformer</b>
<b>a</b>	CT ID name and voltage level	Heptacare Power Industries
<b>b</b>	CT core connection details	5 Core, Core-1 (Prot-1), 2 (B/U), 3 (Metering)
<b>c</b>	Accuracy Class	PS, PS, 0.2, PS, PS
<b>d</b>	Whether Protection/ Metering	Both
<b>e</b>	CT ratio available and ratio adopted	1600/800/1, 800/1
<b>f</b>	Details of last checking and validation of CT healthiness	23.06.2023 at Routine Testing
<b>g</b>	Other requirements for protection checking and validation	NA
<b>h</b>	Other protection: Direction earth fault, negative sequence, over current, over voltage, over frequency, under voltage, under frequency, forward power, reverse power, out of step/ power swing, HVDC protection etc.	Differential Protection/Direction earth fault, over current

<b>100MVA T/F-II</b>		
<b>SL. No.</b>	<b>Equipment</b>	<b>Current Transformer</b>
<b>a</b>	CT ID name and voltage level	(HV) Heptacare Power Industries (LV) Mehru Electrical
<b>b</b>	CT core connection details	5 Core, Core-1 (Prot-1), 2 (B/U), 5 (Metering)
<b>c</b>	Accuracy Class	PS, PS, PS, PS, 0.2
<b>d</b>	Whether Protection/ Metering	Both
<b>e</b>	CT ratio available and ratio adopted	(HV) 1600/800/1, 800/1 (LV) 800/500/1, 500/1
<b>f</b>	Details of last checking and validation of CT healthiness	24.06.2023 at Routine Testing
<b>g</b>	Other requirements for protection checking and validation	NA
<b>h</b>	Other protection: Direction earth fault, negative sequence, over current, over voltage, over frequency, under voltage, under frequency, forward power, reverse power, out of step/ power swing, HVDC protection etc.	Differential Protection/Direction earth fault, over current



<b>40MVA T/F-I</b>		
<b>SL. No.</b>	<b>Equipment</b>	<b>Current Transformer</b>
<b>a</b>	CT ID name and voltage level	Heptacare Power Industries
<b>b</b>	CT core connection details	5 Core, Core-1 (Prot-1), 2 (B/U), 3 (Metering)
<b>c</b>	Accuracy Class	PS, PS, 0.2, PS, PS
<b>d</b>	Whether Protection/ Metering	Both
<b>e</b>	CT ratio available and ratio adopted	1600/800/1, 800/1
<b>f</b>	Details of last checking and validation of CT healthiness	22.08.2023 at Routine Testing
<b>g</b>	Other requirements for protection checking and validation	NA
<b>h</b>	Other protection: Direction earth fault, negative sequence, over current, over voltage, over frequency, under voltage, under frequency, forward power, reverse power, out of step/ power swing, HVDC protection etc.	Differential Protection/Direction earth fault, over current

<b>40MVA T/F-II</b>		
<b>SL. No.</b>	<b>Equipment</b>	<b>Current Transformer</b>
<b>a</b>	CT ID name and voltage level	Heptacare Power Industries
<b>b</b>	CT core connection details	5 Core, Core-1 (Prot-1), 2 (B/U), 3 (Metering)
<b>c</b>	Accuracy Class	PS, PS, 0.2, PS, PS
<b>d</b>	Whether Protection/ Metering	Both
<b>e</b>	CT ratio available and ratio adopted	1600/800/1, 800/1
<b>f</b>	Details of last checking and validation of CT healthiness	22.08.2023 at Routine Testing
<b>g</b>	Other requirements for protection checking and validation	NA
<b>h</b>	Other protection: Direction earth fault, negative sequence, over current, over voltage, over frequency, under voltage, under frequency, forward power, reverse power, out of step/ power swing, HVDC protection etc.	Differential Protection/Direction earth fault, over current

<b>40MVA T/F-III</b>		
<b>SL. No.</b>	<b>Equipment</b>	<b>Current Transformer</b>
<b>a</b>	CT ID name and voltage level	Heptacare Power Industries
<b>b</b>	CT core connection details	5 Core, Core-1 (Prot-1), 2 (B/U), 3 (Metering)
<b>c</b>	Accuracy Class	PS, PS, 0.2, PS, PS
<b>d</b>	Whether Protection/ Metering	Both
<b>e</b>	CT ratio available and ratio adopted	1600/800/1, 800/1
<b>f</b>	Details of last checking and validation of CT healthiness	22.08.2023 at Routine Testing
<b>g</b>	Other requirements for protection checking and validation	NA
<b>h</b>	Other protection: Direction earth fault, negative sequence, over current, over voltage, over frequency, under voltage, under frequency, forward power, reverse power, out of step/ power swing, HVDC protection etc.	Differential Protection/Direction earth fault, over current

## Capacitive Voltage Transformer/Potential Transformer

220KV Pantnagar Line, 38.3km		
SL. No.	Equipment	CVT
a	CVT ID name and voltage level	Make-CGL, 245KV
b	CVT core connection details	110/ $\sqrt{3}$ , 3Core
c	Accuracy Class	3P, 3P, 0.2
d	Whether Protection/ Metering	Both
e	CVT ratio available and ratio adopted	220KV/ 110V
f	Details of last checking and validation of CVT healthiness	05.11.2023 at Routine Testing
g	Other requirements for protection checking and validation	NA
h	Other protection: Direction earth fault, negative sequence, over current, over voltage, over frequency, under voltage, under frequency, forward power, reverse power, out of step/ power swing, HVDC protection etc.	Direction earth fault

<b>132KV Bazpur Line, 35.5km</b>		
<b>SL. No.</b>	<b>Equipment</b>	<b>CVT</b>
<b>a</b>	CVT ID name and voltage level	Make-CGL, 145KV
<b>b</b>	CVT core connection details	110/ $\sqrt{3}$ , 3Core
<b>c</b>	Accuracy Class	3P, 3P, 0.2
<b>d</b>	Whether Protection/ Metering	Both
<b>e</b>	CVT ratio available and ratio adopted	132KV/ 110V
<b>f</b>	Details of last checking and validation of CVT healthiness	26.10.2023 at Routine Testing
<b>g</b>	Other requirements for protection checking and validation	NA
<b>h</b>	Other protection: Direction earth fault, negative sequence, over current, over voltage, over frequency, under voltage, under frequency, forward power, reverse power, out of step/ power swing, HVDC protection etc.	Other protection, Direction earth fault, negative sequence

<b>132KV Kathgodam Line, 8.4km</b>		
<b>SL. No.</b>	<b>Equipment</b>	<b>CVT</b>
<b>a</b>	CVT ID name and voltage level	Make-CGL, 145KV
<b>b</b>	CVT core connection details	110/ $\sqrt{3}$ , 3Core
<b>c</b>	Accuracy Class	3P, 3P, 0.2
<b>d</b>	Whether Protection/ Metering	Both
<b>e</b>	CVT ratio available and ratio adopted	132KV/ 110V
<b>f</b>	Details of last checking and validation of CVT healthiness	07.08.2023 at Routine Testing
<b>g</b>	Other requirements for protection checking and validation	NA
<b>h</b>	Other protection: Direction earth fault, negative sequence, over current, over voltage, over frequency, under voltage, under frequency, forward power, reverse power, out of step/ power swing, HVDC protection etc.	Other protection, Direction earth fault, negative sequence

## Communication System

Sl. No.	Particulars	Details
1	Mode of communication for Main- 1 and Main- 2 protection	Main-1 (OPGW), Main-2 (NA)
2	Mode of communication for data and speech communication	Speech communication- PLCC DATA communication- PLCC – NA
3	Status of PLCC channels	Active
4	Time synchronization equipment details	GPS Clock Make – SANDS
5	OPGW on geographically diversified paths for Main- 1 and Main- 2 relay	Main-1
6	Other requirements for protection checking and validation	NA

## Transformer Protection

SL. No.	Equipment	100MVA T/F-I
a	Whether two groups of protections used (Group A and Group B)	Group A
b	Do the groups have separate DC sources	NA
c	Relay Make and Model	Siemens Siprotec 7UT61, 7SJ621
d	List of all active protections along with settings	Enclosed
e	Status of Differential Protection/ Restricted Earth Fault Protection/ Back-up Directional Overcurrent/ Backup Earth Fault/ Breaker Failure	Differential Protection/Back-up Directional Overcurrent/ Backup Earth Fault Active
f	Status of Oil Temperature Indicator/ Winding Temperature Indicator/ Bucholz/ Pressure Release Device etc.	Oil Temperature Indicator/ Winding Temperature Indicator/ Bucholz/ Pressure Release Device etc Active
g	Relay connected to Trip Coil-1 or 2 or both	Both
h	CT ratio and PT ratio	HV: 800/1, 220KV/110V, LV: 800/1, 132KV/110V
i	Feed from DC supply-1 or 2	DC-1
j	Connected to dedicated CT core (mention name)	Core- 1 (Diff. Prot), 2-(B/U), 3-(Metering)
k	Other requirements for protection checking and validation	NA



<b>SL. No.</b>	<b>Equipment</b>	<b>100MVA T/F-II</b>
<b>a</b>	Whether two groups of protections used (Group A and Group B)	Group A
<b>b</b>	Do the groups have separate DC sources	NA
<b>c</b>	Relay Make and Model	Siemens Siprotec 7UT61, 7SJ621
<b>d</b>	List of all active protections along with settings	Enclosed
<b>e</b>	Status of Differential Protection/ Restricted Earth Fault Protection/ Back-up Directional Overcurrent/ Backup Earth Fault/ Breaker Failure	Differential Protection/Back-up Directional Overcurrent/ Backup Earth Fault Active
<b>f</b>	Status of Oil Temperature Indicator/ Winding Temperature Indicator/ Bucholz/ Pressure Release Device etc.	Oil Temperature Indicator/ Winding Temperature Indicator/ Bucholz/ Pressure Release Device etc Active
<b>g</b>	Relay connected to Trip Coil-1 or 2 or both	Both
<b>h</b>	CT ratio and PT ratio	HV: 800/1, 220KV/110V, LV: 800/1, 132KV/110V
<b>i</b>	Feed from DC supply-1 or 2	DC-1
<b>j</b>	Connected to dedicated CT core (mention name)	Core- 1 (Diff. Prot), 2-(B/U), 3-(Metering)
<b>k</b>	Other requirements for protection checking and validation	NA

<b>SL. No.</b>	<b>Equipment</b>	<b>40MVA T/F-I</b>
<b>a</b>	Whether two groups of protections used (Group A and Group B)	Group A
<b>b</b>	Do the groups have separate DC sources	NA
<b>c</b>	Relay Make and Model	Siemens Siprotec 7UT61, 7SJ621
<b>d</b>	List of all active protections along with settings	Enclosed
<b>e</b>	Status of Differential Protection/ Restricted Earth Fault Protection/ Back-up Directional Overcurrent/ Backup Earth Fault/ Breaker Failure	Differential Protection/Back-up Directional Overcurrent/ Backup Earth Fault Active
<b>f</b>	Status of Oil Temperature Indicator/ Winding Temperature Indicator/ Bucholz/ Pressure Release Device etc.	Oil Temperature Indicator/ Winding Temperature Indicator/ Bucholz/ Pressure Release Device etc Active
<b>g</b>	Relay connected to Trip Coil-1 or 2 or both	Both
<b>h</b>	CT ratio and PT ratio	HV: 800/1, 132KV/110V, LV: 800/1, 33KV/110V
<b>i</b>	Feed from DC supply-1 or 2	DC-1
<b>j</b>	Connected to dedicated CT core (mention name)	Core- 1 (Diff. Prot), 2-(B/U), 3-(Metering)
<b>k</b>	Other requirements for protection checking and validation	NA

<b>SL. No.</b>	<b>Equipment</b>	<b>40MVA T/F-II</b>
<b>a</b>	Whether two groups of protections used (Group A and Group B)	Group A
<b>b</b>	Do the groups have separate DC sources	NA
<b>c</b>	Relay Make and Model	Siemens Siprotec 7UT61, 7SJ621
<b>d</b>	List of all active protections along with settings	Enclosed
<b>e</b>	Status of Differential Protection/ Restricted Earth Fault Protection/ Back-up Directional Overcurrent/ Backup Earth Fault/ Breaker Failure	Differential Protection/Back-up Directional Overcurrent/ Backup Earth Fault Active
<b>f</b>	Status of Oil Temperature Indicator/ Winding Temperature Indicator/ Bucholz/ Pressure Release Device etc.	Oil Temperature Indicator/ Winding Temperature Indicator/ Bucholz/ Pressure Release Device etc Active
<b>g</b>	Relay connected to Trip Coil-1 or 2 or both	Both
<b>h</b>	CT ratio and PT ratio	HV: 800/1, 132KV/110V, LV: 800/1, 33KV/110V
<b>i</b>	Feed from DC supply-1 or 2	DC-1
<b>j</b>	Connected to dedicated CT core (mention name)	Core- 1 (Diff. Prot), 2-(B/U), 3-(Metering)
<b>k</b>	Other requirements for protection checking and validation	NA

<b>SL. No.</b>	<b>Equipment</b>	<b>40MVA T/F-III</b>
<b>a</b>	Whether two groups of protections used (Group A and Group B)	Group A
<b>b</b>	Do the groups have separate DC sources	NA
<b>c</b>	Relay Make and Model	GE P40 Agile (P643), GE Multiline F650
<b>d</b>	List of all active protections along with settings	Enclosed
<b>e</b>	Status of Differential Protection/ Restricted Earth Fault Protection/ Back-up Directional Overcurrent/ Backup Earth Fault/ Breaker Failure	Differential Protection/Back-up Directional Overcurrent/ Backup Earth Fault Active
<b>f</b>	Status of Oil Temperature Indicator/ Winding Temperature Indicator/ Bucholz/ Pressure Release Device etc.	Oil Temperature Indicator/ Winding Temperature Indicator/ Bucholz/ Pressure Release Device etc Active
<b>g</b>	Relay connected to Trip Coil-1 or 2 or both	Both
<b>h</b>	CT ratio and PT ratio	HV: 200/1, 132KV/110V, LV: 800/1, 33KV/110V
<b>i</b>	Feed from DC supply-1 or 2	DC-1
<b>j</b>	Connected to dedicated CT core (mention name)	Core- 1 (Diff. Prot), 2-(B/U), 3-(Metering)
<b>k</b>	Other requirements for protection checking and validation	NA

## Network Diagram of Uttarakhand

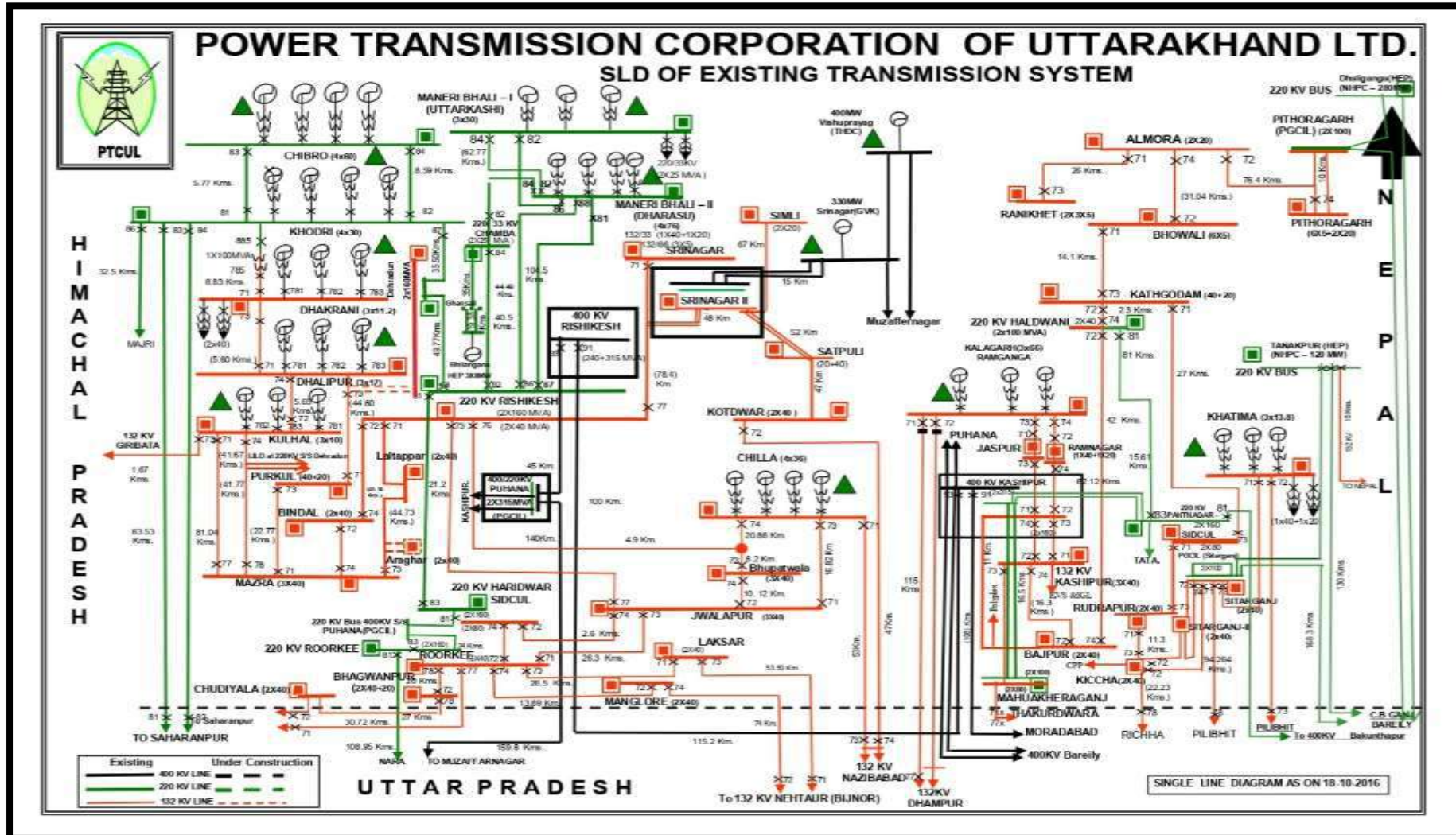



# Power Map of Uttarakhand

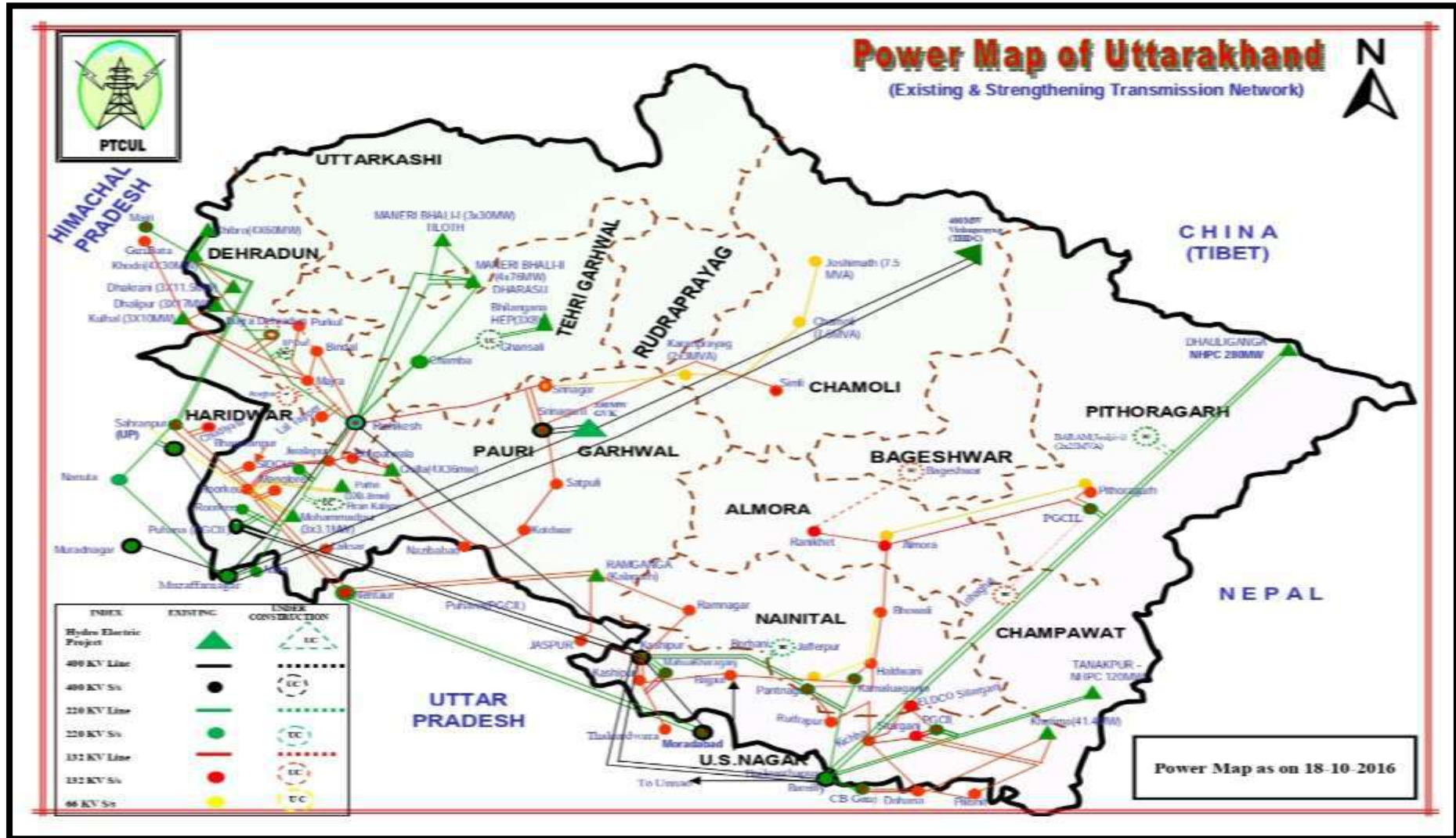



# **Power Transmission Corporation of Uttarakhand Limited**

(A Govt. of Uttarakhand Undertaking)

Corporate ID No.: U40101UR2004SGC028675

## **FINAL REPORT**

### **Protection Audit**

**400/220KV Rishikesh Substation**

**Submitted**

**By**



**CENTRAL BOARD OF IRRIGATION & POWER**

**NEW DELHI**



# केन्द्रीय सिंचाई व शक्ति मंडल CENTRAL BOARD OF IRRIGATION AND POWER

25<sup>th</sup> June 2024

Order No.: 376/SE (T&C)/PTCUL/(H). dated: 29.09.2023

## Protection Audit Report

FINAL PROTECTION AUDIT REPORT OF 400/220 KV RISHIKESH SUBSTATION UNDER POWER TRANSMISSION CORPORATION OF UTTARAKHAND LIMITED (PTCUL), UTTARAKHAND.

**Submitted  
To**



**Power Transmission Corporation of Uttarakhand Limited**  
(A Govt. of Uttarakhand Undertaking)  
Corporate ID No.: U40101UR2004SGC028675



# Contents

<b>Disclaimer</b> .....	6
<b>1.0. Executive Summary</b> .....	7
<b>2.0. Introduction</b> .....	10
2.1. <i>Background</i> .....	10
2.2. <i>Scope of Work</i> .....	10
2.3. <i>Audit Rationale</i> .....	11
2.4. <i>Audit Process</i> .....	12
2.5. <i>About Power Transmission Corporation of Uttarakhand (PTCUL)</i> .....	14
2.6. <i>About Central Board of Irrigation &amp; Power (CBIP)</i> .....	15
<b>3.0. Preliminary Audit of 400kV Rishikesh Substation</b> .....	16
3.1. <i>General Information about Substation</i> .....	16
3.2. <i>Audit Team</i> .....	16
3.3. <i>Recommendation of last protection checking and validation</i> .....	17
3.4. <i>Review of existing settings at substation</i> .....	18
3.5. <i>Disturbance Recorder availability for the last 6 tripping's</i> .....	18
3.6. <i>Chronic reason of tripping, if any</i> .....	18
3.7. <i>Major non-conformity/deficiency observed</i> .....	18
<b>4.0. List of Trippings</b> .....	20
<b>5.0. Observations and Recommendations</b> .....	25
5.1. <i>Reporting of all the Tripping with DR/EL</i> .....	25
5.2. <i>Development of centralized database of relay settings</i> .....	25
5.3. <i>Review of test results of relay and equipment</i> .....	26
5.4. <i>Availability of Testing Kits</i> .....	26
5.5. <i>Up-dation of PTCUL Protection Philosophy</i> .....	26
5.6. <i>Simulation based study of protection system</i> .....	27
5.7. <i>Capacity Building of protection team</i> .....	27
5.8. <i>Updated Fault Level/ Short Circuit Level and Network information</i> .....	27
5.9. <i>General Protection related observations</i> .....	27
5.10. <i>O&amp;M Manual</i> .....	27
<b>6.0. Station Specific Observation and Recommendations</b> .....	28
6.1. <i>Protection related observations and recommendations</i> .....	28
6.2. <i>Equipment related observations and recommendations</i> .....	28
6.3. <i>Auxiliary Equipment related observations and recommendations</i> .....	29
<b>Annexure – 1: Suggested List of Testing Instruments</b> .....	30
<b>Annexure – 2: Suggested List of Substation Equipments</b> .....	31

<b>Annexure – 3: Suggested List of Maintenance Equipments.....</b>	<b>32</b>
<b>Annexure – 4: Protection Code (IEGC 2023 Chapter 4).....</b>	<b>33</b>
<b>Annexure – 5: Third Party Protection System Checking &amp; Validation Template for a Substation (IEGC 2023 Annexure – 1).....</b>	<b>38</b>
<b>Annexure – 6: Protection Philosophy/Protocol of Northern Region .....</b>	<b>43</b>
<b>Annexure – 7: Work Order &amp; Corrigendum.....</b>	<b>49</b>
<b>Annexure – 8: Data Sheets .....</b>	<b>57</b>

## ACRONYMS

<b>A</b>	Ampere
<b>AC</b>	Alternating Current
<b>AMP</b>	Annual Maintenance Plan
<b>CBIP</b>	Central Board of Irrigation and Power
<b>CT</b>	Current Transformer
<b>CVT</b>	Capacitive Voltage Transformer
<b>DC</b>	Direct Current
<b>DG</b>	Diesel Generator
<b>DPR</b>	Detailed Project Report
<b>DR</b>	Disturbance Recorder
<b>EL</b>	Event Logger
<b>EMTP</b>	Electromagnetic Transient Program
<b>EE</b>	Executive Engineer
<b>GPS</b>	Global Positioning System
<b>ICT</b>	Inter Connecting Transformer
<b>IEGC</b>	Indian Electricity Grid Code
<b>JE</b>	Junior Engineer
<b>KA</b>	Kilo Ampere
<b>KV</b>	Kilo Volt
<b>LBB</b>	Local Breaker Backup
<b>LEFT</b>	Earth Fault
<b>MVA</b>	Mega Volt Ampere
<b>NA</b>	Not Available
<b>NRPC</b>	Northern Regional Power Committee
<b>O&amp;M</b>	Operation & Maintenance
<b>OCC</b>	Operation Coordination Sub Committee

<b>PLCC</b>	Power Line Carrier Communication
<b>PSC</b>	Power System Sub Committee
<b>PSDF</b>	Power System Development Fund
<b>PT</b>	Potential Transformer
<b>PTCUL</b>	Power Transmission Corporation of Uttarakhand Limited.
<b>RLDC</b>	Regional Load Dispatch Centre
<b>RPC</b>	Regional Power Committee
<b>SAS</b>	Substation Automation System
<b>SE</b>	Superintendent Engineer
<b>SCADA</b>	Supervisory Control & Data Acquisition
<b>SLD</b>	Single Line Diagram
<b>SLDC</b>	State Load Dispatch Centre
<b>SOTF</b>	Switch On-To Fault
<b>SPS</b>	Special Protection Scheme
<b>T&amp;C</b>	Testing & Commissioning
<b>UJVNL</b>	Uttarakhand Jal Vidyut Nigam Ltd
<b>UPCL</b>	Uttarakhand Power Corporation Ltd
<b>WTI</b>	Winding Temperature Indicator

## Disclaimer

The protection audit has been carried out based on the guidelines provided under various documents mentioned in the report. For the purpose of audit, the auditor(s) have relied upon the data made available by the client and information & clarifications made available, in the written or verbal form, by the officials of clients during site visit and later.

The report is not for public distribution and has been furnished solely for information and must not be reproduced or redistributed to others, except those concerned. No one can use the report as a base for any claim, demand or cause of action and, also no one is responsible for any loss incurred based upon the content of this report.

While every effort is made to ensure the accuracy and completeness of information contained, CBIP takes no responsibility and assumes no liability for any error/ omission or accuracy of the information. Recipients of this material should rely on their own judgments and conclusions from relevant sources before taking any decision.

## 1.0. Executive Summary

PTCUL awarded the work of Third-Party Protection Audit of 2 nos. 400kV and 8 nos. 220kV substations of PTCUL (“Utility”) to CBIP. CBIP planned the audit as per Audit process provided under Protection Code within Indian Electricity Grid Code 2023. In addition, the guidelines of Ramakrishna Committee for checking and validation and NRPC guidelines for Third Party Audit were also adhered too. The CBIP manual on protection (manual no 247-Revised), NRPC protection philosophy were also referred too.

As a part of audit process, utility was asked to provide set of information before start of audit. Team from CBIP consisting of Mr. Vijay Barthwal, Mr. M.R. Chauhan, Mr. Shivam Gupta & Mr. Avichal Panday visited 400/220KV Rishikesh Substation during 19<sup>th</sup> – 20<sup>th</sup> February 2024 and preliminary audit report was submitted on the spot. The representatives of utility were present during this process. Some more information was sought from the Utility.

Based on the data made available by Utility, draft of final report was submitted to Utility and after discussions, report was finalized. The details of audit process, data made available by Utility, observations from preliminary report and detailed observations and recommendations are provided in this report. Key observations and recommendations are summarized below.

### **General Observations and Recommendations for Organization Level implementation**

01. It is recommended that each substation to have a central repository for tripping reports, along with Time Synchronized DR/EL reports and analysis. A dedicated PC can be provided at each substation for the purpose.
02. The protection philosophy adopted by Utility, in general, is in alignment with protection philosophy adopted by NRPC. As the NRPC has recently updated the protection philosophy, PTCUL in consultation with SLDC may update protection philosophy for network not covered by NRPC too, if needed, and implement the same.
03. It is recommended that latest recommended relay settings, as per the NRPC protocol for 220KV & above Substations, along with setting calculations & parameters used for all the relays, be kept at each substation. This will help in proper fault analysis and ascertaining relay healthiness. Similarly, Relay settings for sub-stations below 220kV, based on any such protocol by SLDC, along with setting calculations and line parameters also needs to be maintained.
04. It is recommended that the detailed reports of test results for the relays and switchyard equipments be maintained at sub-station level.

05. Based on “Draft O&M Manual” of PTCUL and discussions with their officials, a list of testing equipment is suggested and enclosed at Annexure - 1. Also, a list of switchyard maintenance equipment is placed at annexure -3. It is recommended that the necessary testing and maintenance equipment at substation/Sub-division/Division be arranged for regular testing and maintenance of equipment at substations.
06. Simulation based studies or EMTP Studies should be carried out by the Utility, as per the requirement of IEGC-2023.
07. For the protection system and SAS, PTCUL may undertake capacity building exercise for the officials involved in these activities.
08. It is recommended that the updated network information and short circuit level should be periodically reviewed and maintained at central level for revising the setting as per requirement.
09. It is suggested that utility may carry out exhaustive safety and technical audit of sub-stations apart from protection audit, either internally or thru’ third party for implementing the best practices in the sub-station.
10. It is suggested that the existing draft O&M manual be updated to take care of latest developments.

#### **Observations and Recommendations for 400/220KV Rishikesh Sub-Station**

01. Previous protection audit was carried out by NRPC on dated: 2nd November 2012. The issues highlighted were complied.
02. Based on list of tripping submitted by utility for last 12 months, frequent trippings/ auto reclosures of 400 kV Rishikesh Nehtaur line are observed. All 4 tripping are due to (Bird fault) with AN fault (Red Phase) and Out of 7 auto reclosures 6 are due to bird fault in which 4 are on phase CN (Blue Phase) and 2 are on AN (Red Phase). It is suggested to analyse the trippings and take corrective action, wherever possible.
03. The SAS GUI time is not synchronised and displays time different from GPS. It is suggested to take necessary remedial measures for the same.
04. It is recommended that the status of 50 MVAR and 25 MVAR Shunt reactors be kept updated in the SLD.
05. The electromechanical differential relay on 50MVAR reactor) is under replacement. The status needs to be updated.
06. Earth Fault in both 220V battery bank was observed. It is recommended to take necessary corrective action.

07. Emergency DG set operation is not operational. It is recommended to keep the DG set in operation.
08. Based on inputs provided by utility and analysis of data a list of suggested switchyard and maintenance equipment for replacement is provided in Annexure – 2.



## 2.0. Introduction

### 2.1. Background

The work has been awarded to the Central Board of Irrigation & Power (CBIP) vide Work Order Number: 376/SE (T&C)/PTCUL/(H), dated: 29.09.2023 for Protection Audit of 02 Nos. 400KV and 08 Nos. 220KV Sub-Stations at Uttarakhand, for Power Transmission Corporation of Uttarakhand Limited (PTCUL) in reference to the offer submitted by CBIP to PTCUL vide ref. no. P-1/CBIP/PTCUL/Audit/2023, dated: 11.09.2023. A Kick-Off Meeting was held between PTCUL and CBIP at the office of SE (T&C), PTCUL, Kathgodam, Haldwani on 26<sup>th</sup> October 2023. Detailed discussions were held regarding process and methodology of Execution and Submission of reports of Protection Audit. As per the above-mentioned meeting, a corrigendum was released by PTCUL vide ref. no. 394/SE (T&C)/PTCUL/(H), dated: 26.10.2023.

**As per the given order, the protection audit of following sub-stations is to be carried out**

1. 400kV Rishikesh
2. 400kV Kashipur
3. 220kV Chamba
4. 220kV Rishikesh
5. 220kV Roorkee
6. 220kV Haridwar (SIDCUL)
7. 220kV Jhajra
8. 220kV Pantnagar
9. 220kV Haldwani
10. 220kV Mahuakheraganj

### 2.2. Scope of Work

Review of the implemented protection schemes/philosophy for 400/220 kV substations which includes protection of transmission lines, interconnecting transformers, line/bus reactors, bus bar, bus couplers etc. with respect to tripping in last one year as per latest guidelines of Ramakrishna committee/ CBIP/NRPC/International best practices, which includes review of the following:

- a. *Adequacy of primary and backup protection settings for protected equipment and suggest corrective measures.*
- b. *Availability/healthiness of PLCC communication links used for protection systems.*
- c. *Healthiness/adequacy of 220/110/50V DC system available at substations for protection application.*
- d. *Availability/healthiness of GPS system and time synchronization facility used for protection.*
- e. *Availability/healthiness of recording instruments like DRs /ELs for transmission lines protection.*
- f. *Test reports for assessing the healthiness of circuit breakers, CT & CVT based upon available test reports at sites.*
- g. *Field inspection of protection device for obsolescence of technology, suitability and healthiness.*
- h. *Prepare recommendation for replacement of obsolescence relays with compatible numerical relays will be provided.*
- i. *Checking of availability of DG Set / auxiliary DC supply at substations.*

### **2.3. Audit Rationale**

- a. PTCUL (Utility) has submitted a DPR for Replacement of certain equipment under PSDF scheme to Grid-India. Grid-India has asked PTCUL to carry out protection audit of certain substations.
- b. In addition, as per CERC IEGC 2023 Chapter-04 (Protection Code) Para - 15 (2) “All users shall also conduct third party protection audit of each substation at 220KV and above (132KV and above in NER) once in 5 years or earlier as advised by the respective RPC”.
- c. As per Para – 15 (4) of said Code, “The third-party protection audit report shall contain information sought in the format enclosed as Annexure–1. The protection audit reports, along with action plan for rectification of deficiencies detected, if any, shall be submitted to the respective RPC and RLDC or SLDC, as the case may be, within a month of submission of third-party audit report. The necessary compliance to such protection audit report shall be followed up regularly in the respective RPC”.
- d. Subsequently NRPC issued protection philosophy for Northern region developed in compliance of IEGC 2023, Version 2.0 which was approved in 71<sup>st</sup> NRPC meeting held on 29.01.2024. Accordingly, protection audit of 220KV and above Substations is being carried out by CBIP, as per Annexure -1 of IEGC-2023.

## 2.4. Audit Process

- PTCUL shall provide the following documents:
  - a. The Network Diagram, covering the relevant assets
  - b. Latest relay settings adopted and calculations for respective sub-stations and transmission lines.
  - c. Annual maintenance plan (AMP), including the schedule and activities covered under AMP
  - d. Any specific issues covered under OCC and/or PSC of NRPC for relevant assets.
- For each sub-station, check-list shall be provided by PTCUL. During field visit, the information shall be verified.
- The minimum set of points on which checking and validation shall be carried out is provided as per annexure - 4 for the following available power system elements at station, as per attached formats:

Sl. No.	Elements
1	Transmission Line
2	Bus Reactor/Line Reactor
3	Inter-connecting Transformer
4	Busbar
5	AC auxiliary system
6	DC auxiliary system
7	Communication system
8	Circuit Breaker Details
9	Current Transformer Details
10	Capacitive Voltage Transformers Details
11	Any other equipment/system relevant for protection system operation

- During field visit, no testing of equipment and relay shall be carried out. The visual inspection, operational log shall be considered for audit purpose, apart from the documents provided by PTCUL.

- A calibrated multi-meter shall be provided at sub-station for checking AC and DC voltages and currents online, wherever feasible, without impacting the sub-station operations.
- The preliminary report shall be prepared on the site and shall be signed by all the parties present, as given below:

S. No.	Issues	Remarks
1	Recommendation of last protection checking and validation	Status of works and pending issues if any
2	Review of existing settings at substation	Recommended Action
3	Disturbance Recorder out/ available for last 6 tripping's (Y/N)	Recommended Action
4	Chronic reason of tripping, if any	Recommended Action
5	Major non-conformity/deficiency observed	Recommended Action

- **The Final summary shall specifically mention minimum following points:**
  - The settings and scheme adopted are in line with agreed protection philosophy or any accepted guidelines (e.g., Ramakrishna guidelines or CBIP manual based).
  - The deviations from the RPC protection philosophy, if any and reasons for taking the deviations shall be recorded.
  - All the major general deficiency shall be listed in detail along with remedial recommendations.
  - The cases of protection maloperation (last 1 year) shall be analysed from tripping reports and the causes of failure along with corrective actions and recommendations based on the findings.

## ***2.5. About Power Transmission Corporation of Uttarakhand (PTCUL)***

The State of Uttarakhand's power transmission utility, PTCUL, was formerly known as Uttaranchal. According to the Uttar Pradesh State Reorganization Act 2000, this 27<sup>th</sup> state of the republic of India was formed on November 9, 2000, by dividing the Himalayan and surrounding North-Western districts of Uttar Pradesh.

The State of Uttaranchal in exercise of the power granted to it under section 63(4) of the State Re-Organization Act, 2000, formed two separate companies in power sector:

- Uttaranchal Jal Vidyut Nigam Ltd. (UJVNL) – For generation of Hydro-Electricity in the State.
- Uttaranchal Power Corporation Ltd. (UPCL) – For Transmission and Distribution of Electricity in the state.

Enactment of the Electricity Act 2003, a distinct watershed in the Indian Power Sector, made it mandatory for all the States to restructure their SEBs. As per the provisions of Electricity Act 2003, the State Government separated power transmission business from UPCL which was left only with distribution of electricity.

In order to manage Power Transmission Operations, a new company called Power Transmission Corporation of Uttaranchal Ltd. was established. On 27<sup>th</sup> May, 2004, the firm was formed as a Government Company in accordance with section 617 of the Companies Act, 1956. It began operating from 1<sup>st</sup> June, 2004.

The company's corporate and registered office is located in Vidyut Bhawan, Saharanpur Road, Majra, Dehradun, next to the ISBT Crossing.

## ***2.6. About Central Board of Irrigation & Power (CBIP)***

The Government of India established the Central Board of Irrigation and Power in 1927, making it a Premier Institution. For the past 93 years, CBIP has provided committed services to the nation's professional associations, engineers, and individuals involved in the power, water resources, and renewable energy sectors. While serving the country equally and to great honour, CBIP has developed into an esteemed institution of international significance. CBIP is Indian chapter for 10 international organizations related to Power & Water resources sectors.

CBIP is involved in executing various activities such as, International Conferences, Technical Documents Publications, Training Activities, Research & Development, Consultancy Services including Technical, Protection & Safety Audits.

### 3.0. Preliminary Audit of 400kV Rishikesh Substation

#### 3.1. General Information about Substation

Sl. No.	Particulars	Details
1	Substation Name	400/220 kV Rishikesh Substation
2	Name of Owner Utility	Power Transmission Corporation of Uttarakhand Limited (PTCUL)
3	Voltage Level (s) or highest voltage level	400/220 kV
4	Short circuit current rating of all equipment (for all voltage level)	400 kV = 50kA/3 secs, 220 kV = 40 kA/sec,
5	Date of commissioning of the substation	16 <sup>th</sup> February 1983
6	Checking and validation date	19 <sup>th</sup> – 20 <sup>th</sup> February 2024

#### 3.2. Audit Team

##### Audit Team (CBIP)

- Mr. Vijay Barthwal
- Mr. M.R. Chauhan
- Mr. Shivam Gupta
- Mr. Avichal Pandey

##### PTCUL Representative

- Er. Harsh Verma, Executive Engineer (T&C)
- Er. Sarika Thakur, Executive Engineer (O&M)
- Er. Vikas Basant, Assistant Engineer (T&C)
- Er. Abhinav Kumar, Assistant Engineer (O&M)

### ***3.3.Recommendation of last protection checking and validation***

As per the information received, previous protection audit was carried out by NRPC, dated: 2<sup>nd</sup> November 2012.

**a. Following observation were recorded during previous audit:**

<b>Sl. No.</b>	<b>Observation</b>	<b>Compliance action</b>
<b>1</b>	Inspected switchyard and found no leaks in BHEL ICT which was commissioned in 1983. The maintenance has been outstanding.	Done
<b>2</b>	ICT- 2 got burned. A new ICT is being planned and after receipt of this ICT depending on turret CT ratio, the relay setting of ICT – 2 will be adopted.	Done
<b>3</b>	There is no GPS available. The same to be procured and ensure the time sync of all relays which have time sync port.	Done
<b>4</b>	There is no event logger available.	Done
<b>5</b>	The numerical relays are to be connected using a serial/optical/ethernet port to a common PC to enable downloading of DR files.	Done
<b>6</b>	Observed DC fault on both 220V source-I & II. This is to be attended on top priority.	Done



### ***3.4.Review of existing settings at substation***

- a. Utility has provided relay settings adopted for various feeders and transformers.
- b. The record of different relay setting calculations is not available at the substation level.
- c. All relays are numeric, therefore, as per internal protocol of utility relays are tested only at the time of commissioning/change in setting. Copy of test reports not available at substation level.

### ***3.5.Disturbance Recorder availability for the last 6 tripping's***

- a. No independent DR/EL is provided. The DR and EL data are taken from the individual numerical relays and SAS.
- b. The inputs from the DR reports from numerical relays are available in the server.
- c. Utility is submitting Disturbance Recorder data for all lines to NRLC Portal.
- d. The record of DR/EL is available for previous tripping.

### ***3.6.Chronic reason of tripping, if any***

- a. Based on list of tripping submitted by utility for last 12 months, it is noticed that 400 kV Rishikesh Nehtaur line tripped 4 times all 4 tripping are due to (Bird fault) with AN fault (Red Phase). Out of 7 auto reclosures 6 are due to bird fault in which 4 are on phase CN (Blue Phase) and 2 are on AN (Red Phase).

### ***3.7.Major non-conformity/deficiency observed***

- a. SAS is in operation and being used. At times synchronization is provided through 2 GPS systems one for SAS and other for relays and panels. Both GPS are found in sync.
- b. The SAS GUI takes the time from window operating system therefor the time synchronization of windows OS needs to be done at proper interval.
- c. The 400 KV bus is provided with double main and transfer scheme.
- d. The 50 MVR shunt reactor is not provided with circuit breaker which is shown in SLD and in under process for procurement/installation. The TBC breaker and transfer bus is used for switching in and switching out the bus reactor.
- e. For 400 kV Rishikesh Roorkee line both protection P442 and P444 are of same make and same characteristics but different model is present.

- f. For 400 kV Rishikesh - Nehtaur line both protection P442 and P444 are of same make and same characteristics but different model is present.
- g. 25 MVAR shunt reactor on tertiary side of both transformer is obsolete and not in use although shown in SLD.
- h. 1 Nos electromechanical relay (differential relay on 50MVAR reactor) under replacement.
- i. DC earth fault noticed in both the systems.
- j. The auxiliary supply is received from two sources i.e. 132 kV IDPL and 33 kV S/S Rishikesh. One 312.5 KVA DG set is provided as back-up.

## 4.0. List of Trippings

### Trippings

Name of Line	Date	Tripping Time	Closing Time	Outage time (hrs.)	Flags Observed	Remark
<b>400KV O&amp;M Division, Virbhadra, Rishikesh</b>						
400 KV Rishikesh-Nehtaur Line	03-04-2023	00:51	01:59	01:08	<p><b>Control Panel-</b> Main -1 D.P. Start, main-2 D.P. start, Main -I &amp; 2 Prot. trip,  <b>Relay Panel- Main-1:-</b> Active group-1, started phase A-N, Trip Phase A, start element Distance, E/F start 1N-1, TOC Start, Distance Trip, Date &amp; Time 03/04/23 00:50:40:167hrs, fault duration 55.07ms, relay trip time 80.04ms  <b>Fault Location :-</b> 53.73Km, IA=3.987KA, IB=337.2A, IC=339.0A, VAN= 128.8KV, VBN= 244.4KV, VCN=237.10KV, Fault Resistance =3.096 Ohm fault in Zone = 1 86 AX, 86A1, 86A2 &amp; 27R  <b>Main-2:-</b> Active group-1, started phase, A-N, Trip Phase A, start element Distance ,E/F start 1N-1, TOC Start, Distance Trip, Date &amp; Time 03/04/23, 00:50:40:166hrs, fault duration 56.69ms, relay trip time 80.04ms  <b>Fault Location :-</b> 53.90Km, IA=4.015KA, IB=339.7A, IC=340.2A, VAN= 128.9KV, VBN= 244.8KV, VCN=237.0KV, Fault Resistance =3.178 Ohm fault in Zone = 1, 86AX,86A1,86A2 &amp; 27R</p>	Due to Bird's Fault
	03-04-2023	18:40	20:28	01:48	<p><b>Control Panel-</b> Main -1 D.P. Start, main-2 D.P. start,Main -I &amp; 2 Prot. trip,  <b>Relay Panel- Main-1:-</b> Active group-1, started phase A-N, Trip Phase A,start element Distance ,E/F start 1N-1,TOC Start, Distance Trip ,Date &amp; Time 03/04/23 18:40:12:804hrs , fault duration 58.53ms, relay trip time 80.27ms  <b>Fault Location :-</b> 53.30Km, IA=4.011KA, IB=274.6A, IC=369.9A, VAN= 129.4KV, VBN= 240.1KV, VCN=233.50KV, Fault Resistance =3.309 Ohm fault in Zone =1  <b>Main-2:-</b> Active group-1, started phase A-N, Trip Phase A,start element Distance ,E/F start 1N-1,TOC Start, Distance Trip, Date &amp; Time 03/04/23 18:40:12:803hrs , fault duration 56.86ms, relay trip time 80.27ms  <b>Fault Location :-</b>53.38Km, IA=4.010KA, IB=273.2A, IC=368.9KV, VAN= 129.3KV, VBN= 241.0KV, VCN=233.5KV, Fault Resistance = 3.343 Ohm fault in Zone = 1, 86 AX,86A1,86A2 &amp; 27R</p>	Due to Bird's Fault
	23-07-2023	13:25	17:01	03:36	<p>C.P.- Main -1 D.P. Start, main-2 D.P. start, Main -I &amp; 2 Prot. trip, Auto Reclose Lock out  RP:- Main-1:- Active group-1, started phase A-N, Trip Phase -A B.C,start Element Distance ,E/F start 1N-1,TOC Start, SOTF - TOR Trip,Distance Trip ,Date &amp; Time 23/07/23 15:27:48:017hrs ,A/R Lockout Shot &gt;, fault duration 58.55ms, relay trip time 80.30ms  Fault Location :-12.75Km, IA=6.407KA, IB=84.66A, IC=80.21A, VAN=108.6KV,</p>	Due to Bird's Fault

Name of Line	Date	Tripping Time	Closing Time	Outage time (hrs.)	Flags Observed	Remark
					VBN= 260.8KV, VCN=240.1KV, Fault Resistance = 14.56 Ohm fault in Zone = 1 Main-2:- Active group-1, started phase A-N, Trip Phase -A B.C,start Element Distance ,E/F start 1N-1,TOC Start, SOTF -TOR Trip,Distance Trip, Date & Time 23/07/23, 15:27:48:017hrs, A/R Lockout Shot >, fault duration 58.55ms, relay trip time 80.29ms Fault Location :-12.83Km, IA=6.375KA, IB=89.33A, IC=80.65A, VAN=108.2KV, VBN= 260.0KV, VCN= 239.8KV 86AX,86BX,86CX,86T1,86T2,186AX,186BX ,186CX,27R,27Y, SOTF TRIP A/R Lockout C/S,C/R, A/R Lockout	
<b>400 KV Rishikesh-Nehtaur Line</b>	18-08-2023	15:54	20:21	04:13	Control Panel- Main 1 trip ,Main 2 trip,A/R Operated alarm. Relay Panel- START PH a-n, trip ph A,B,C, START ELEMENT DISTANCE, E/F start in 1, toc start, A/R L/O Trip, FD-91.70Ms, rtt-80ms Fault Location-10.66 KM. Ia-6.88KA, Ib-84.14A, Ic-81.33A, VAN-81KV, VBN-259.4KV, VCN, 241.3KV, ZONE 1, C/S, A/R OPTD., A/R L/O.C/R, 86A1, 86B1, 86C1, 86T1, 86T2, 186 AX, 86A2, 86B2, 86C2, 86AX, 86BX, 86CX ., 186 CX.	Due to Bird's Fault

### Auto Reclose

Name of Line	Date	Tripping Time	Closing Time	Outage time (hrs.)	Flags Observed	Remark
<b>400 kV O&amp;M Division, Virbhadra, Rishikesh</b>						
Rishikesh - Nehtaur Line	04-05-2023	03:04	03:04	00:00	<b>CP-</b> Main -1 , 2 Distance Protection Start, Main -1,2,Distance Protection ,Trip A/R OPTD Alarm <b>R.P.-</b> Main -1 Active Group -1 Start Phase C-N, Trip Phase-C, Start Element Distance, Earth Fault Start :IN-1, TOC-Start, Distance Trip Zone -1, Fault Duration-60.06ms, Relay Trip Time-80.08ms, <b>Fault Location :-34.96Km, IC=5.025KA, VCN=110.1KV, Fault Resistance in Ohm - 3.266Ohm</b> Main -2 Start Phase C-N, Trip Phase-C,Start Element Distance, Earth Fault Start :IN-1, TOC-Start, Distance Trip Zone -1, Fault Duration-60.01ms, Relay Trip Time-80.00ms, Fault Location :-35.04Km, IC-5.026KAmp, VCN-110.3KV, Fault Resistance in Ohm - 3.235Ohm	Due to Bird's Fault
	20-06-2023	03:54	03:54	00:00	<b>CP-</b> Main -1 , 2 Distance Protection Start, Main -1,2, Distance Protection ,Trip A/R OPTD Alarm <b>R.P.-</b> Main -1 Active Group -1 Start Phase A-	Due to Bird's Fault

Name of Line	Date	Tripping Time	Closing Time	Outage time (hrs.)	Flags Observed	Remark
					N, Trip Phase-A, Start Element Distance, Earth Fault Start :IN-1, TOC-Start, Distance Trip Zone -1, Fault Duration-59.96ms, Relay Trip Time-79.95ms, <b>Fault Location : 55.06Km, IA=4.005KA, VAN=130.4.KV, Fault Resistance in Ohm - 3.006Ohm</b> Main -2 Start Phase A-N, Trip Phase-A,Start Element Distance, Earth Fault Start :IN-1, TOC-Start, Distance Trip Zone -1, Fault Duration-58.3ms, Relay Trip Time-79.95ms, Fault Location :-55.02Km, IA-4.009KAmp, VAN-130.5KV, Fault Resistance in Ohm - 2.987Ohm	
	27-06-2023	05:03	05:03	00:00	<b>CP-</b> Main -1 , 2 Distance Protection Start, Main -1,2,Distance Protection ,Trip A/R OPTD Alarm <b>R.P.-</b> Main -1 Active Group -1 Start Phase C-N, Trip Phase-C, Start Element Distance, Earth Fault Start :IN-1, TOC-Start, Distance Trip Zone -1, Fault Duration-54.95ms, Relay Trip Time-79.92ms, <b>Fault Location :-34.55Km, IC=4.988KA, VCN=108.0KV, Fault Resistance in Ohm - 3.127Ohm</b> Main -2 Start Phase C-N, Trip Phase-C, Start Element Distance, Earth Fault Start :IN-1, TOC-Start, Distance Trip Zone -1, Fault Duration-56.61ms, Relay Trip Time-79.92ms, Fault Location :-34.62Km, IC-5.121KAmp, VCN-108.2KV, Fault Resistance in Ohm - 3.078Ohm	Due to Bird's Fault
	15-07-2023	09:02	09:02	00:00	<b>CP-</b> Main -1 , 2 Distance Protection Start, Main -1,2, Distance Protection ,Trip A/R OPTD Alarm <b>R.P.-</b> Main -1 Active Group -1 Start Phase A-N, Trip Phase-A, Start Element Distance, Earth Fault Start :IN-1, TOC-Start, Distance Trip Zone -1, Fault Duration-54.88ms, Relay Trip Time-79.82ms, <b>Fault Location : 58.49Km, IA=3.821KA, VAN=132.1.KV, Fault Resistance in Ohm - 3.415Ohm</b> Main -2 Start Phase A-N, Trip Phase-A,Start Element Distance, Earth Fault Start :IN-1, TOC-Start, Distance Trip Zone -1, Fault Duration-56.54ms, Relay Trip Time-79.82ms, Fault Location :-58.52Km, IA-3.829KAmp, VAN-131.9KV, Fault Resistance in Ohm - 3.400Ohm	Due to Bird's Fault
Rishikesh - Nehtaur Line	23-07-2023	13:23	13:23	00:00	<b>CP-</b> Main -1 , 2 Distance Protection Start, Main -1,2, Distance Protection ,Trip A/R OPTD Alarm <b>R.P.-</b> Main -1 Active Group -1 Start Phase A-N, Trip Phase-A, Start Element Distance, Earth Fault Start :IN-1, TOC-Start, Distance Trip Zone -1, Fault Duration-70.09ms, Relay Trip Time-80.10ms, <b>Fault Location : 14.57Km, IA=5.922KA, VAN=117.4KV, Fault Resistance in Ohm - 17.11Ohm</b> Main -2 Start Phase A-N, Trip Phase-A,Start Element Distance, Earth Fault Start :IN-1, TOC-Start, Distance Trip Zone -	Due to Tree

Name of Line	Date	Tripping Time	Closing Time	Outage time (hrs.)	Flags Observed	Remark
					1, Fault Duration-52.4ms, Relay Trip Time-80.10ms, Fault Location :- 11.15Km, IA-6.316KAmp, VAN-114KV, Fault Resistance in Ohm -11.23Ohm	
	08-09-2023	01:01	01:01	00:00	<b>CP-</b> Main -1 ,2 Distance Protection Start,Main -1,2,Distance Protection ,Trip A/R OPTD Alarm <b>R.P.-</b> Main -1 Active Group -1 Start Phase C-N,Trip Phase-C,Start Element Distance, Earth Fault Start :IN-1, TOC-Start, Distance Trip Zone -1, Fault Duration-58.41ms,Relay Trip Time-80.11ms, <b>Fault Location :-</b> 60.24Km, IA-373.2Amp, IB-373.1Amp, IC-3.500KAmp,VAN-234.2KV, BN-234.3KV, VCN-147.9KV, Fault Resistance in Ohm -17.29Ohm Main -2 Start Phase C-N,Trip Phase-C,Start Element Distance, Earth Fault Start :IN-1, TOC-Start, Distance Trip Zone -1, Fault Duration-58.42ms,Relay Trip Time-80.11ms, Fault Location :-60.45Km, IA-371.2Amp, IB-368.2Amp, IC-3.498KAmp,VAN-233.9KV, VBN-234.6KV,VCN-149.0KV, Fault Resistance in Ohm -17.44Ohm, Z1 ,C/S,C/R, A/R OPTD,86C1,86C2,86CX	Due to Bird's Fault
	28-09-2023	11:08	11:08	00:00	CP- Main -1, 2 Distance Protection Start,Main -1,2,Distance Protection ,Trip A/R OPTD Alarm <b>R.P.-</b> Main -1 Active Group -1 Start Phase C-N,Trip Phase-C,Start Element Distance, Earth Fault Start :IN-1, TOC-Start, Distance Trip Zone -1, Fault Duration-55.02ms,Relay Trip Time-80.02ms, Fault Location :-35.07Km, IA-242.1Amp,IB-373.1Amp, IC-4.720KAmp,VAN-229.6KV, VBN-232.4KV,VCN-104.1KV, Fault Resistance in Ohm -3.206Ohm Main -2 Start Phase C-N,Trip Phase-C,Start Element Distance, Earth Fault Start :IN-1, TOC-Start, Distance Trip Zone -1, Fault Duration-56.68ms,Relay Trip Time-80.02ms, Fault Location :-35.02Km, IA-231.04Amp, IB-294.2Amp, IC-3.498KAmp,VAN-230.1KV, VBN-232.2KV,VCN-103.8KV, Fault Resistance in Ohm -3.255Ohm, Z1 , C/S, C/R, A/R OPTD, 86C1, 86C2, 86CX	Due to Bird's Fault
Rishikesh-Roorkee Line	23-05-2023	21:05	21:05	00:00	<b>CP-</b> Main -1 , 2 Distance Protection Start, Main -1,2,Distance Protection ,Trip A/R OPTD Alarm <b>R.P.-</b> Main -1 Active Group -1 Start Phase C-N, Trip Phase-C, Start Element Distance, Earth Fault Start :IN-1, TOC-Start, Distance Trip Zone -1, Fault Duration-56.66ms, Relay Trip Time-79.98ms, <b>Fault Location :-</b> 37.11Km, IC=2.408KA, VCN=84.21KV, Fault Resistance in Ohm - 3.822Ohm	Due to Bird's Fault
	14-06-2023	14:22	14:22	00:00	<b>CP-</b> Main -1 , 2 Distance Protection Start, Main -1,2, Distance Protection ,Trip A/R OPTD Alarm <b>R.P.-</b> Main -1 Active Group -1 Start Phase C-N, Trip Phase-C, Start Element Distance,	Due to land human cutting the tree

Name of Line	Date	Tripping Time	Closing Time	Outage time (hrs.)	Flags Observed	Remark
					Earth Fault Start :IN-1, TOC-Start, Distance Trip Zone -1, Fault Duration-51.79ms, Relay Trip Time-80.19ms, <b>Fault Location :-6.81Km, IC=3.910KA, VCN=126.KV, Fault Resistance in Ohm - 36.09Ohm</b>	
	11-08-2023	06:31	06:31	00:00	<b>CP-</b> Main -1 , 2 Distance Protection Start, Main -1, 2, Distance Protection ,Trip A/R OPTD Alarm <b>R.P.-</b> Main -1 Active Group -1 Start Phase B-N, Trip Phase-B, Start Element Distance, Earth Fault Start :IN-1, TOC-Start, Distance Trip Zone -1, Fault Duration-51.66ms, Relay Trip Time-0.00ms, IB=1.59KA, VBN=137.3.KV	Rkee-Mzn line Auto Reclosed and flage observed same time this line

## 5.0. Observations and Recommendations

### 5.1. Reporting of all the Tripping with DR/EL

- a. For the interstate lines, as per IEGC clause 37.2(c) and clause 15.3 of CEA grid standard, all the DR/EL reports shall be uploaded on Web Based Tripping Monitoring System “http://103.7.128.184/Account/Login.aspx” within 24 hours of the events. These are being submitted by sub-station to NRLDC portal, however the record of the same is not kept at sub-station level.

Status of submission of FIR/DR/EL/Tripping Report on NR Tripping Portal																	
Time Period: 1st January 2024 - 31st January 2024																	
S. No.	Utility	Total No. of tripping	First Information Report (Not Received)		Disturbance Recorder (Not Received)		Disturbance Recorder (NA) as informed by utility		Event Logger (Not Received)		Event Logger (NA) as informed by utility		Tripping Report (Not Received)		Tripping Report (NA) as informed by utility	Tripping Report (Not Received)	Remark
			Value	%	Value	%	Value	%	Value	%	Value	%					
36	SLDC-PS	29	2	7	13	6	57	13	5	54	16	0	55				
37	SLDC-RS	130	12	9	23	11	19	23	9	19	39	0	30				
38	SLDC-UK	6	0	0	0	4	0	0	4	0	1	3	33				DR, EL & Tripping report need to be submitted
39	SLDC-UP	80	10	13	11	9	15	12	30	17	11	1	14				
40	STERLITE	1	0	0	0	0	0	0	0	0	0	1	0				Details received
41	TANAKPUR-NH	4	1	25	1	0	25	1	0	25	1	0	25				DR, EL & Tripping report need to be submitted
42	LUNCHAAR-NT	1	0	0	0	0	0	0	1	0	0	0	0				Details received
Total in NR Region		538	147	28	169	68	37	171	70	38	185	17	37				

*As per the IEGC provision under clause 37.2 (c), detailed tripping report along with DR & EL has to be furnished within 24 hrs of the occurrence of the event*

Ref: NRPC 216 OCC Agenda (Annexure B.VIII)

- b. For the tripping of intra-state lines, the brief tripping reports are submitted to Divisional office. The DR/EL reports are downloaded by respective officials and forwarded, as per need basis. The record of these DR/EL is not kept at sub-stations
- c. It is recommended that each sub-station to have a central repository of such tripping reports, along with DR/EL reports and analysis. A dedicated PC can be kept for this.

### 5.2. Development of centralized database of relay settings

- a. In 48th TCC & 70th NRPC Meeting (held on 17-18 Nov 2023), NRPC Committee has approved for development of a portal through PSDF for Centralized database containing details of relay settings for grid elements connected to 220 kV and above. Portal shall have other features including protection setting calculation tool. A nodal officer shall be providing this data at central portal.
- b. The relay settings for below 220kV are to be calculated by SLDC and/or central level. The relays are tested by sub-station officials as per need basis, but the record of recommended settings/ calculation is not kept at sub-station level. This makes it difficult to validate the settings and test results, in case of relay testing.



- c. It is recommended that latest recommended relay settings, as decided by RLDC for 220kV & above and by SLDC below 220kV along with setting calculations & parameters used for all the relays be kept at sub-station level. This will help in proper fault analysis and ascertaining relay healthiness.

### **5.3. *Review of test results of relay and equipment***

- a. Testing of most of the equipment is carried out, as per availability of shut-down and testing equipment. After testing, the test records are summarily recorded in testing register, with remarks as “tested. OK”.
- b. For the numeric relay testing, the testing is carried out by supplier at the time of installation and subsequently as per need basis, including at the time of change in settings.
- c. A draft O&M manual is available at PTCUL web-site, which includes various tests and their frequency, along with results. This manual is based on CERC/SERC regulations of 2004-2008. It is recommended that this manual may be updated and implemented and record of test values may be kept for future reference.

### **5.4. *Availability of Testing Kits***

- a. The availability of testing equipment is limited at each substation. For comprehensive testing of equipment, as per above para, sufficient testing kits at each substation/Sub-division/ Division level are required.
- b. Based on the O&M manual, it is recommended that sufficient quantity of testing instruments be made available at sites for regular testing of equipment. A suggested list of Testing Equipment is attached at Annexure – 1.

### **5.5. *Up-dation of PTCUL Protection Philosophy***

The protection philosophy adopted by Utility, in general, is in alignment with protection philosophy adopted by NRPC. As the NRPC has recently updated the protection philosophy, PTCUL in consultation with SLDC may update protection philosophy for network not covered by NRPC, if needed, and implement the same.

### **5.6. *Simulation based study of protection system***

As per IEGC, protection code, during audit the relay settings to be adopted shall be validated with simulation based or EMTP studies and details shall be enclosed in report. The current scope of audit was excluding these studies, therefore, Simulation based or EMTP Studies should be carried out by the Utility, as per the requirement of Grid Code.

### **5.7. *Capacity Building of protection team***

During the discussions with officials at site, it was observed that the teams responsible for the protection system and SAS, needs to be updated on current trends on protection system, communication schemes and Sub-station automation. Utility may undertake capacity building exercise for the officials involved in these activities.

### **5.8. *Updated Fault Level/ Short Circuit Level and Network information***

The fault level/ short circuit level for each substation is being calculated at central level. Such studies are carried out, as and when new elements are added in the network. This has impact on relay settings parameters and equipment ratings. It is recommended that the updated network information and short circuit level be maintained at central level for revising the setting as per requirement.

### **5.9. *General Protection related observations***

The study of Fire protection system/ Nitrogen Injection Fire Protection System, Lightning Protection system, Earthing Mat/ Earthing Protection are not covered under protection audit. Utility may get a comprehensive technical and safety audit carried out internally or thru third party and corrective action for any discrepancy be taken up accordingly.

### **5.10. *O&M Manual***

The Utility has a draft O&M manual uploaded on its website, which is being referred by working level officials as a guideline for regular O&M and testing functions. This manual needs to be updated to incorporate recent developments and approved for regular use in all sub-stations to bring uniformity in O&M and testing practices across the utility.

## **6.0. Station Specific Observation and Recommendations**

### **6.1. Protection related observations and recommendations**

- a. Based on list of tripping submitted by utility for last 12 months, frequent trippings/ auto reclosures of 400 kV Rishikesh Nehtaur line are observed. All 4 tripping are due to (Bird fault) with AN fault (Red Phase) and Out of 7 auto reclosures 6 are due to bird fault in which 4 are on phase CN (Blue Phase) and 2 are on AN (Red Phase). It is suggested to analyse the trippings and take corrective action, wherever possible.
- b. SAS is in operation and being used. At times synchronization is provided through 2 GPS systems one for SAS and other for relays and panels. Both GPS are found in sync. The SAS GUI takes the time from window operating system. As the system is not connected to internet, the window time is not synchronised, therefore the time synchronization of windows OS needs to be done at regular interval, otherwise clock of SAS GUI shows different time. It is suggested to take necessary remedial measures for the same.
- c. The 50 MVR shunt reactor is not provided with circuit breaker which is shown in SLD and in under process for procurement/installation. The TBC breaker and transfer bus is used for switching in and switching out the bus reactor. 25 MVAr shunt reactor on tertiary side of both transformer is obsolete and not in use although shown in SLD. It is recommended that SLD be kept updated.
- d. 1 Nos electromechanical relay (differential relay on 50MVAr reactor) under replacement. The status needs to be updated.

### **6.2. Equipment related observations and recommendations**

Many of the equipment are recently replaced. Any requirement of equipment and spares may be reviewed by PTCUL.

In addition, it is recommended that sufficient quantity of maintenance equipments be made available at sites. A suggested list of Maintenance Equipment is attached at Annexure – 3.

### ***6.3. Auxiliary Equipment related observations and recommendations***

- a. Both the 220V DC systems are showing severe earth-fault. The necessary corrective action needs to be taken asap to avoid any unwanted tripping in future.
- b. The auxiliary supply is received from two sources i.e. 132 kV IDPL and 33 kV S/S Rishikesh and is quite reliable. One 312.5 KVA DG set is provided as back-up, but is not operational. Necessary action may be taken to keep the DG operational.

## Annexure – 1: Suggested List of Testing Instruments

CBIP suggests the following list of testing instruments based on the approved O&M manual

Sl. No.	Testing Instruments
1	DCRM for Circuit Breaker
2	DC Earth Fault Locator
3	SF6 Gas Density Monitor
4	SF6 Gas Leakage detector/ Imaging Camera
5	CB Analyser
6	Earth Resistance Tester
7	Portable Digital Selective Level Meter cum Level Generator
8	Selective Level Generator
9	LA Leakage Current Analyser
10	Digital Multi-meter
11	Tong Tester
12	Tan Delta Test Kit
13	Digital Leakage Clamp Meter
14	Phase Sequence Indicator
15	Megger (5 kV)
16	Digital Capacitance Meter
17	CT Polarity Tester
18	PT Test Set

## **Annexure – 2: Suggested List of Substation Equipments**

**NIL**

### Annexure – 3: Suggested List of Maintenance Equipments

Sl. No.	Equipment
1	Oil Filter Machine
2	SF6 Gas Handling Plant
3	SF6 Gas Density Monitor
4	Thermo-Vision Camera Lines and Sub-Station
5	Binocular Vision Camera
6	SF6 Gas Leakage Imaging Camera
7	LA Leakage Current Analyser
8	Online DGA
9	Oil BDV Kit
10	Hydraulic Crimping Tool for different Types of ACSR Conductor
11	Hydraulic Conductor Cutter
12	Fork Lift 5 Ton Capacity
13	Digital Leakage Clamp Meter

A mobile van with test kits can be kept for optimizing the resources at various substations

## Annexure – 4: Protection Code (IEGC 2023 Chapter 4)

- **General**

1. This chapter covers the protection protocol, protection settings and protection audit plan of electrical systems.
2. There shall be a uniform protection protocol for the users of the grid:
  - a) for proper co-ordination of protection system in order to protect the equipment/system from abnormal operating conditions, isolate the faulty equipment and avoid unintended operation of protection system;
  - b) to have a repository of protection system, settings and events at regional level;
  - c) specifying timelines for submission of data;
  - d) to ensure healthiness of recording equipment including triggering criteria and time synchronization; and
  - e) to provide for periodic audit of protection system.

- **Protection protocol**

1. All users connected to the integrated grid shall provide and maintain effective protection system having reliability, selectivity, speed and sensitivity to isolate faulty section and protect element(s) as per the CEA Technical Standards for Construction, the CEA Technical Standards for Connectivity, the CEA (Grid Standards) Regulations, 2010, the CEA Technical Standards for Communication and any other applicable CEA Standards specified from time to time.
2. Back-up protection system shall be provided to protect an element in the event of failure of the primary protection system.
3. RPC shall develop the protection protocol and revise the same, after review from time to time, in consultation with the stakeholders in the concerned region, and in doing so shall be guided by the principle that minimum electrical protection functions for equipment connected with the grid shall be provided as per the CEA Technical Standards for Construction, the CEA Technical Standards for Connectivity, the CEA Technical Standards for Communication, the CEA (Grid Standards) Regulations, 2010, the CEA (Measures relating to Safety and Electric Supply) Regulations, 2010, and any other CEA standards specified from time to time.



4. The protection protocol in a particular system may vary depending upon operational experience. Changes in protection protocol, as and when required, shall be carried out after deliberation and approval of the concerned RPC.
5. Violation of the protection protocol of the region shall be brought to the notice of concerned RPC by the concerned RLDC or SLDC, as the case may be.

- **Protection settings**

1. RPCs shall undertake review of the protection settings, assess the requirement of revisions in protection settings and revise protection settings in consultation with the stakeholders of the respective region, from time to time and at least once in a year. The necessary studies in this regard shall be carried out by the respective RPCs. The data including base case (peak and off-peak cases) files for carrying out studies shall be provided by RLDC and CTU to the RPCs:
2. All users connected to the grid shall:
  - a) furnish the protection settings implemented for each element to respective RPC in a format as prescribed by the concerned RPC;
  - b) obtain approval of the concerned RPC for,
    - i. any revision in settings, and,
    - ii. implementation of new protection system;
  - c) intimate to the concerned RPC about the changes implemented in protection system or protection settings within a fortnight of such changes;
  - d) ensure correct and appropriate settings of protection as specified by the concerned RPC.
  - e) ensure proper coordinated protection settings.
3. RPCs shall:
  - a) maintain a centralized database and update the same on periodic basis in respect of their respective region containing details of relay settings for grid elements connected to 220 KV and above (132 KV and above in NER). RLDCs shall also maintain such database.
  - b) carry out detailed system studies, once a year, for protection settings and advise modifications / changes, if any, to the CTU and to all users and STUs of their respective regions. The data required to carry out such studies shall be provided by RLDCs and CTU.

- c) provide the database access to CTU and NLDC and to all users, RLDC, SLDCs, and STUs of the respective regions. The database shall have different access rights for different users.
4. The changes in the network and protection settings of grid elements connected to 220KV and above (132 KV and above in NER) shall be informed to RPCs by CTU and STUs, as the case may be.

The elements of network below 66KV and radial in nature which do not impact the National Grid may be excluded as finalized by the respective RPC.

- **Protection audit plan**

1. All users shall conduct internal audit of their protection systems annually, and any shortcomings identified shall be rectified and informed to their respective RPC. The audit report along with action plan for rectification of deficiencies detected, if any, shall be shared with respective RPC for users connected at 220 KV and above (132 KV and above in NER).
2. All users shall also conduct third party protection audit of each substation at 220 KV and above (132 KV and above in NER) once in five years or earlier as advised by the respective RPC.
3. After analysis of any event, each RPC shall identify a list of substations / and generating stations where third-party protection audit is required to be carried out and accordingly advise the respective users to complete third party audit within three months.
4. The third-party protection audit report shall contain information sought in the format enclosed as Annexure–1. The protection audit reports, along with action plan for rectification of deficiencies detected, if any, shall be submitted to the respective RPC and RLDC or SLDC, as the case may be, within a month of submission of third-party audit report. The necessary compliance to such protection audit report shall be followed up regularly in the respective RPC.
5. Annual audit plan for the next financial year shall be submitted by the users to their respective RPC by 31<sup>st</sup> October. The users shall adhere to the annual audit plan and report compliance of the same to their respective RPC.
6. Users shall submit the following protection performance indices of previous month to their respective RPC and RLDC on monthly basis for 220 KV and above (132 KV and above in NER) system, which shall be reviewed by the RPC:
  - b. The Dependability Index defined as

$$D = \frac{N_c}{N_c + N_f}$$

where,

$N_c$  is the number of correct operations at internal power system faults and

$N_f$  is the number of failures to operate at internal power system faults.

- c. The Security Index defined as

$$S = \frac{N_c}{N_c + N_u}$$

where,

$N_c$  is the number of correct operations at internal power system faults

$N_u$  is the number of unwanted operations.

- d. The Reliability Index defined as

$$R = \frac{N_c}{N_c + N_i}$$

where,

$N_c$  is the number of correct operations at internal power system faults

$N_i$  is the number of incorrect operations and is the sum of  $N_f$  and  $N_u$

7. Each user shall also submit the reasons for performance indices less than unity of individual element wise protection system to the respective RPC and action plan for corrective measures. The action plan will be followed up regularly in the respective RPC.
8. In case any user fails to comply with the protection protocol specified by the RPC or fails to undertake remedial action identified by the RPC within the specified timelines, the concerned RPC may approach the Commission with all relevant details for suitable directions.

- **System Protection Scheme (SPS)**

1. SPS for identified system shall have redundancies in measurement of input signals and communication paths involved up to the last mile to ensure security and dependability.
2. For the operational SPS, RLDC or NLDC, as the case may be, in consultation with the concerned RPC(s) shall perform regular load flow and dynamic studies and mock testing for reviewing SPS parameters & functions, at least once in a year.
3. RLDC or NLDC shall share the report of such studies and mock testing including any short comings to respective RPC(s). The data for such studies shall be provided by CTU to the concerned RPC, RLDC and NLDC.
4. The users and SLDCs shall report about the operation of SPS immediately and detailed report shall be submitted within three days of operation to the concerned RPC and RLDC in the format specified by the respective RPCs.
5. The performance of SPS shall be assessed as per the protection performance indices specified in these Regulations. In case, the SPS fails to operate, the concerned User shall take corrective actions and submit a detailed report on the corrective actions taken to the concerned RPC within a fortnight.

- **Recording instruments**

1. All users shall keep the recording instruments (disturbance recorder and event logger) in proper working condition.
2. The disturbance recorders shall have time synchronization and a standard format for recording analogue and digital signals which shall be included in the guidelines issued by the respective RPCs.
3. The time synchronization of the disturbance recorders shall be corroborated with the PMU data or SCADA event loggers by the respective RLDC. Disturbance recorders which are non-compliant shall be listed out for discussion at RPC.

## **Annexure – 5: Third Party Protection System Checking & Validation Template for a Substation (IEGC 2023 Annexure – 1)**

### **1. Introduction:**

- a. The audit reports, along with action plan for rectification of deficiencies found, if any, shall be submitted to RPC or RLDC within a month of submission of report by auditor.
- b. The third-party protection system checking shall be carried at site by the designated agency. The agency shall furnish two reports:
  - i. Preliminary Report: This report shall be prepared on the site and shall be signed by all the parties present.
  - ii. Detailed Report: This report shall be furnished by agency within one month after carrying out detailed analysis.

### **2. Checklist:**

- a. The protection system checklist shall contain information as per this Regulation.
  - i. General Information (to be provided prior to the checking as well as to be included in final report):
    - Substation name
    - Name of Owner Utility
    - Voltage Level (s) or highest voltage level
    - Short circuit current rating of all equipment (for all voltage level) (v) Date of commissioning of the substation
    - Checking and validation date
    - Record of previous tripping's (in last one year) and details of protection operation
    - Previous Relay Test Reports
    - Overall single line diagram (SLD) (x) AC aux SLD
    - DC aux SLD
    - SAS architecture diagram
    - SPS scheme implemented (if any)
  - b. The preliminary report shall inter-alia contain the following:

## FORMAT OF PRELIMINARY REPORT

S. No.	Issues	Remarks
1	<b>Recommendation of last protection checking and validation</b>	Status of works & pending issues if any
2	<b>Review of existing settings at substation</b>	Recommended Action
3	<b>Disturbance Recorder out/ available for last 6 trippings (Y/N)</b>	Recommended Action
4	<b>Chronic reason of tripping, if any</b>	Recommended Action
5	<b>Major non-conformity/deficiency observed</b>	Recommended Action

c. The **relay configuration check-list** for available power system elements at station:

- Transmission Line
- Bus Reactor/Line Reactor
- Inter-connecting Transformer
- Busbar Protection Relay
- AC auxiliary system
- DC auxiliary system
- Communication system
- Circuit Breaker Details
- Current Transformer details
- Capacitive Voltage Transformers Details
- Any other equipment/system relevant for protection system operation

d. The **minimum set of points on which checking & validation** shall be carried out is covered in this clause. The detailed list shall be prepared by checking and validation team in consultation with concerned entity, RLDC and RPC.

**i. Transmission Line Distance Protection/Differential Protection;**

- Name and Length of Line
- Whether series compensated or not
- Mode of communication used (PLCC/OPGW)
- Relay Make and Model for Main-I and Main-II
- List of all active protections & settings

- Carrier aided scheme if any
- Status of Power Swing/Out of Step/SOTF/Breaker Failure/Broken Conductor/STUB/Fault Locator/DR/VT fuse fail/Overvoltage Protection/Trip Circuit supervision/Auto-reclose/Load encroachment etc.
- Relay connected to Trip Coil-1 or 2 or both i. CT ratio and PT ratio
- Feed from DC supply-1 or 2
- Connected to dedicated CT core (mention name)
- Other requirements for protection checking and validation

**ii. Shunt Reactor & Inter-connecting Transformer (ICT) Protection;**

- Whether two groups of protections used (Group A and Group B)
- Do the groups have separate DC sources
- Relay Make and Model
- List of all active protections along with settings
- Status of Differential Protection/Restricted Earth Fault Protection/Back-up Directional Overcurrent/Backup Earth fault/ Breaker Failure
- Status of Oil Temperature Indicator/Winding-Temperature Indicator/Bucholz/Pressure Release Device etc.
- Relay connected to Trip Coil-1 or 2 or both
- CT ratio and PT ratio
- Feed from DC supply-1 or 2
- Connected to dedicated CT core (mention name)
- Other requirements for protection checking and validation

**iii. Busbar Protection Relay;**

- Busbar and redundant relay make and model
- Type of Busbar arrangement
- Zones
- Dedicated CT core for each busbar protection (Yes/No)
- Breaker Failure relay included (Yes/No), if additional then furnish make and model
- Trip issued to both Busbar protection in case of enabling
- Isolator indication and check relays
- Other requirements for protection checking and validation

**iv. AC auxiliary system;**

- Source of AC auxiliary system
- Supply changeover between sources (Auto/Manual)
- Diesel generator (DG) details
- Maintenance plan and supply changeover periodicity in DG
- Single Line Diagram
- Other requirements for protection checking and validation

**v. DC auxiliary system;**

- Type of Batteries (Make, vintage, model)
- Status of battery Charger
- Measured voltage (positive to earth and negative to earth)
- Availability of ground fault detectors
- Protection relays and trip circuits with independent DC sources
- Other requirements for protection checking and validation
- Communication system
  - Mode of communication for Main-1 and Main-2 protection
  - Mode of communication for data and speech communication
  - Status of PLCC channels
  - Time synchronization equipment details
  - 7OPGW on geographically diversified paths for Main-1 and main-2 relay
  - Other requirements for protection checking and validation

**vi. Circuit Breaker Details;**

- Details and Status
- Healthiness of Tripping Coil and Trip circuit supervision relay
- Single Pole/Multi pole operation
- Pole Discrepancy Relay available (Y/N)
- Monitoring Devices for checking the dielectric medium
- Other requirements for protection checking and validation
- Current Transformer (CT)/Capacitive Voltage Transformer (CVT) Details
  - CT/CVT ID name and voltage level
  - CT/CVT core connection details
  - Accuracy Class



- Whether Protection/Metering
- CT/CVT ratio available and ratio adopted
- Details of last checking and validation of CT/CVT healthiness
- Other requirements for protection checking and validation
- Other protections: Direction earth fault, negative sequence, over current, over voltage, over frequency, under voltage, under frequency, forward power, reverse power, out of step/power swing, HVDC protection etc.

### 3. Summary of checking:

The summary shall specifically mention minimum following points:

- a) The settings and scheme adopted are in line with agreed protection philosophy or any accepted guidelines (e.g. Ramakrishna guidelines or CBIP manual based).
- b) The deviations from the RPC protection philosophy, if any and reasons for taking the deviations shall be recorded.
- c) All the major general deficiency shall be listed in detail along with remedial recommendations.
- d) The relay settings to be adopted shall be validated with simulation based or EMTP studies and details shall be enclosed in report.
- e) The cases of protection maloperation shall be analysed from protection indices report furnished by concerned utility, the causes of failure along with corrective actions and recommendations based on the findings shall be noted in the report.

## Annexure – 6: Protection Philosophy/Protocol of Northern Region

The Protection Philosophy/Protocol of Northern Region is developed in compliance of IEGC 2023, Version 2.0 which was approved in 71<sup>st</sup> NRPC meeting held on 29.01.2024.

S.N.	Protection Setting/Protocol	Mandated Setting for transmission lines
1	<b>Protection Scheme</b>	<p>220KV and above: Independent Main-I and Main-II protection (of different make OR different type/different algorithm) of non-switched numerical type is to be provided with carrier aided scheme.</p> <p>132KV and below: One non-switched distance protection scheme and, directional over current and earth fault relays, should be provided as back up.</p>
2	<b>Distance Protection Zone-1</b>	<p>Reach: 80% of the protected line; 110% of the protected line (In case of radial lines) Time Setting: Instantaneous.</p>
3	<b>Distance Protection Zone-2</b>	<p>Reach: Single Circuit Line: 120% of length of principle line section. Double circuit line: 150% coverage of line to take care of under reaching due to mutual coupling effect.</p> <p>Time setting: i. 0.35 second <i>(considering LBB time of 200mSec, CB open time of 60ms, resetting time of 30ms and safety margin of 60ms)</i> ii. 0.5-0.6 second <i>(For a long line followed by a short line)</i></p>

S.N.	Protection Setting/Protocol	Mandated Setting for transmission lines
4	<b>Distance Protection Zone-3</b>	<p>Reach: Zone-3 should overreach the remote terminal of the longest adjacent line by an acceptable margin (typically 20% of highest impedance seen) for all fault conditions.</p> <p>Time Setting: 800-1000 msec</p> <p>If zone-3 reach transcends to other voltage level, time may be taken up to 1.5 sec.</p>
5	<b>Distance Protection Zone- 4</b>	<p>The Zone-4 reverse reach must adequately cover expected levels of apparent bus bar fault resistance.</p> <p>Time may be coordinated accordingly.</p> <p>Where Bus Bar protection is not available, time setting: 160 msec.</p>
6	<b>Lines with Series and other compensations in the vicinity of Substation</b>	<ul style="list-style-type: none"> <li>• Zone-1: FSC end: 60% of the protected line. Time: Instantaneous; Remoted end: 60% of the protected line with 100ms-time delay. POR Communication scheme logic is modified such that relay trips instantaneously in Zone-1 on carrier receive.</li> <li>• Zone-2: 120 % of uncompensated line impedance for single circuit line. For Double circuit line, settings may be decided on basis of dynamic study in view of zero sequence mutual coupling.</li> <li>• Phase locked voltage memory is used to cope with the voltage inversion. Alternatively, an intentional time delay may be applied to overcome directionality problems related to voltage inversion.</li> <li>• Over-voltage stage-I setting for series compensated double circuit lines may be kept higher at 113%.</li> </ul>

S.N.	Protection Setting/Protocol	Mandated Setting for transmission lines
7	<b>Power Swing Blocking</b>	<ul style="list-style-type: none"> <li>• Block tripping in all zones, all lines.</li> </ul> Out of Step tripping to be applied on all inter-regional tie lines. Deblock time delay = 2s
8	<b>Protection for broken conductor</b>	Negative Sequence current to Positive Sequence current ratio more than 0.2 (i.e. $I_2/I_1 \geq 0.2$ ) Alarm Time delay: 3-20 sec. Tripping may be considered for radial lines to protect single phasing of transformers.
9	<b>Switch on to fault (SOTF)</b>	Switch on to fault (SOTF) function to be provided in distance relay to take care of line energization on fault.
10	<b>VT fuse fail detection function</b>	VT fuse fail detection function shall be correctly set to block the distance function operation on VT fuse failure.
11	<b>Carrier Protection</b>	To be applied on all 220KV and above lines with the only exception of radial feeders.
12	<b>Back up Protection</b>	<ol style="list-style-type: none"> <li>1. On 220KV and above lines with 2 Main Protections:               <ul style="list-style-type: none"> <li>• Back up Earth Fault protections alone to be provided.</li> <li>• No Over current protection to be applied.</li> </ul> </li> <li>2. At 132KV and below lines with only one Main protection:               <ul style="list-style-type: none"> <li>• Back up protection by IDMT O/C and E/F to be applied.</li> </ul> </li> </ol>

S.N.	Protection Setting/Protocol	Mandated Setting for transmission lines
13	<b>Auto Reclosing with dead time.</b>	<p>AR shall be enabled for 220 KV and above lines for single pole trip and re-closing.            Dead time = 1.0s. Reclaim time = 25.0s</p> <p>Auto-recloser shall be blocked for following:</p> <ul style="list-style-type: none"> <li>• Faults in cables</li> <li>• Breaker Fail Relay</li> <li>• Line Reactor Protections</li> <li>• O/V Protection</li> <li>• Received Direct Transfer trip signals</li> <li>• Busbar Protection</li> <li>• Zone 2/3 of Distance Protection</li> <li>• Circuit Breaker Problems.</li> </ul> <p>CB Pole discrepancy relay time:1.5 sec; for tie breaker: 2.5 sec</p>
14	<b>Busbar protection</b>	To be applied on all 220KV and above sub stations with the only exception of 220KV radial fed bus bars.
15	<b>Local Breaker Backup (LBB)</b>	<p>For 220 KV and above level substations as well as generating stations switchyards, LBB shall be provided for each circuit breaker.</p> <p>LBB Current sensor I &gt; 20% In LBB time delay = 200ms</p> <p>In case of variation in CT ratio, setting may be done accordingly.</p>
16	<b>Line Differential</b>	<p>For cables and composite lines, line differential protection with built in distance back up shall be applied as Main-I protection and distance relay as Main-II protection.</p> <p>For very short line (less than 10 km), line differential protection with distance protection as</p>

S.N.	Protection Setting/Protocol	Mandated Setting for transmission lines
		<p>backup (built- in Main relay or standalone) shall be provided mandatorily as Main-I and Main-II.</p> <p>Differential protection may be done using dark fiber (preferably), or using bandwidth.</p>
17	<b>Over Voltage Protection</b>	<p>FOR 765KV LINES/CABLE:  Low set stage (Stage-I): 106% - 109% (typically 108%) with a time delay of 5 seconds.  High set stage (Stage-II): 140% - 150% with a time delay of 100 milliseconds.</p> <p>400KV LINES/CABLE:  Low set stage (Stage-I): 110% - 112% (typically 110%) with a time delay of 5 seconds.  High set stage (Stage-II): 140% - 150% with a time delay of 100 milliseconds.</p> <p>FOR 220 KV LINES:  No over-voltage protection shall be used.</p> <p>FOR 220 KV CABLE:  Low set stage (Stage-I): 110% - 112% (typically 110%) with a time delay of 5 seconds.  High set stage (Stage-II): 140% - 150% with a time delay of 100 milliseconds.</p> <p>Drop-off to pick-up ratio of overvoltage relay:  better than 97%</p> <p>Grading: Voltage as well as time grading may be done for multi circuit lines/cable.</p>

S.N.	Protection Setting/Protocol	Mandated Setting for transmission lines
18	<b>Resistive reach setting to prevent load point encroachment</b>	<p>Following criteria may be considered for deciding load point encroachment:</p> <ul style="list-style-type: none"> <li>• Maximum load current (<math>I_{max}</math>) may be considered as 1.5 times the thermal rating of the line or 1.5 times the associated bay equipment current rating (the minimum of the bay equipment individual rating) whichever is lower. (Caution: The rating considered is approximately 15minutes rating of the transmission facility).</li> <li>• Minimum voltage (<math>V_{min}</math>) to be considered as 0.85pu (85%).</li> </ul>
19	<b>Direct Inter-trip</b>	<p>To be sent on operation of following:</p> <ol style="list-style-type: none"> <li>i. Overvoltage Protection</li> <li>ii. LBB Protection</li> <li>iii. Busbar Protection</li> <li>iv. Reactor Protection</li> <li>v. Manual Trip (400 KV and above)</li> <li>vi. Cable Fault (in composite lines)</li> </ol>
20	<b>Permissive Inter-trip</b>	To be sent on operation of Distance Protection

## Annexure – 7: Work Order & Corrigendum



पावर ट्रांसमिशन कारपोरेशन ऑफ उत्तराखण्ड लि0  
(उत्तराखण्ड सरकार का उपक्रम)  
अधीक्षण अभियन्ता (परीक्षण एवं परिचालन एवं स्काडा) कार्यालय  
कुमांयु मण्डल हल्द्वानी  
मोबाइल नं0 9412089275, ईमेल dp\_singh@ptcul.org

No. 376 /SE (T&C)/PTCUL/ (H)/

Date:29.09.2023

Subject:- Order for Protection Audit of 02 Nos 400 kV and 08 Nos 220KV sub-stations in PTCUL.

Joint Advisor

Central Board of Irrigation and Power

Malcha Marg Chanakyapuri,

New Delhi-110021

Email: mrchauhan@cbip.org.

Dear Sir,

In reference to your offer submitted vide Ref No: P-1/CBIP/PTCUL/PTCUL/Audit/2023 dated: 11.09.2023 through email against Email enquiry dated 05.09.2023, an order is hereby placed in favour of your firm for the work of "Protection Audit of 02 Nos 400kV and 08 Nos 220 kV substations of PTCUL" The detail of material, price schedule and terms & conditions is here as under:-

Sr.No	Description	Unit	Qty	Amount	Total Amount
1	Protection Audit to be carried out for the following 10 nos of the 400/220kV substations of PTCUL :- 1. 400kV S/s Rishikesh 2. 400 kV S/s Kashipur 3. 220kV S/s Chamba 4. 220kV S/s Rishikesh 5. 220kV S/s Roorkee 6. 220kV S/s Haridwar (SIDCUL) 7. 220kV S/s Jhajra. 8. 220 kV S/s Pantnagar. 9. 220 kV S/s Haldwani. 10. 220kV S/s Mahuakheraganj.	Job	1	36,25,000	36,25,000
TOTAL					36,25,000

Total value of order is Rs.36,25,000 (Rupees Thirty Six Lakh Twenty Five Thousand only ) Plus GST Extra.

End: 1. Terms & Conditions.

Please acknowledge the receipt and acceptance of order.

(D.P Singh)

Superintending Engineer (T&C), Haldwani

No.376 /SE (T&C)/PTCUL/ (H)/

Date:29.09.2023

Copy forwarded to the following for information and necessary action:-

1. Director (Operation), PTCUL, Dehradun.
2. Superintending Engineer (A) MD, PTCUL, Dehradun.
3. Chief Engineer, T&C PTCUL, 132kV Substation Campus, Kathgodam Nainital.
4. Executive Engineer, T&C Division, Kashipur.
5. Director (Energy), Central Board of Irrigation and Power Malcha Marg Chanakyapuri, New Delhi-110021 Email: [sanjeev@cbip.org](mailto:sanjeev@cbip.org)

(D.P Singh)

Superintending Engineer (T&C), Haldwani

मुख्यालय एवंपंजीकृत कार्यालय:-विद्युतमवन, नजदीक-आई0एस0बी0टी0 क्रासिंग, सहारनपुररोड, माजरा, देहरादून-248002  
कारपोरेटआईडी नं0: U40101UR2004GOI028675 दूरभाष नं0 0135-2646000 फॅक्स नं0 0135-2643460 वेबसाइट [www.ptcul.org](http://www.ptcul.org)





पावर ट्रांसमिशन कारपोरेशन ऑफ उत्तराखण्ड लि0  
(उत्तराखण्ड सरकार का उपक्रम)  
अधीक्षण अभियन्ता (परीक्षण एवं परिचालन एवं स्काडा) कार्यालय  
कुमायु मण्डल हल्द्वानी  
मोबाइल नं0 9412089275, ईमेल dp\_singh@ptcul.org

Terms & Conditions:-

1	Scope	<p>: The detailed Scope work is as under:</p> <ol style="list-style-type: none"><li>1. There must be a kick off meeting for discussion on project plan before start of the work in field and the detailed plan of performance shall be submitted by CBIP.</li><li>2. Requisite data shall be collected in standard format from PTCUL grid substations by authorized and experienced auditor.</li><li>3. The site surveys and audit of grid substations of PTCUL shall be done by authorized and experienced auditor.</li><li>4. Review of the implemented protection schemes/philosophy for 400/220 kV substations which includes protection of transmission lines,interconnecting transformers, line/busreactors, bus bar, bus couplers etc.as per latest guidelines of Ramakrishna committee/CBIP/NRPC/Intenational best practices.etc.</li><li>5. Review the adequacy of primary and backup protection settings for protected equipment and suggest corrective measures where evernon compliance with respect to Ramakrishna committee/ CBIP/NRPC is found during the protection audit.</li><li>6. Review of availability/healthiness of PLCC communication links used for protection systems.</li><li>7. Review the healthiness/adequacy of 220/110/50V DC system available at substations for protection application.</li><li>8. Review of availability/healthiness of GPS system and time synchronization facility used for protection.</li><li>9. Review of availability/healthiness of recording instruments like DRs /ELs for transmission lines protection.</li><li>10. Review of test reports for assessing the healthiness of circuit breakers, CT &amp; CVT based upon available test reports at sites.</li><li>11. Field inspection of protection device for obsolescence of technology, suitability and healthiness.</li><li>12. Directory of the protection system &amp; recommendation for replacement of obsolescence relays with compatible numerical relays will be provided.</li><li>13. Checking of availability of DGset/auxiliary DC supply at substations.</li><li>14. Site visits for onsite protection audit, review and inspection of substations will be performed.</li><li>15. Submission of the detailed report for the protection audit including the protection philosophy, reviewed settings and protection audit observations.</li><li>16. The performance of above protection equipment like relays, circuit breaker, CT, CVT, DC battery bank, synchro facility, communication facility used for protection will be also checked through physical inspection and provided test reports/documents. These protection equipments will be recommended for renovation and upgradation based on their performance accessed during protection audit and physical inspection.</li><li>17. Review the availability healthiness of<ul style="list-style-type: none"><li>• Event recorders/ loggers' operation history</li><li>• CT, CVT, CB</li><li>• DC power supply</li><li>• Auxiliary supply</li><li>• Communication links</li><li>• Time synchronization/ GPS</li></ul></li><li>18. Review of Testing and Maintenance records of all protective relays, Circuit Breakers CT, CVT etc. Review of protection philosophy.</li></ol>
---	-------	--

मुख्यालय एवंपंजीकृत कार्यालय:-विद्युतमवन, नजदीक-आई0एस0बी0टी0 क्रासिंग, सहारनपुररोड, माजरा, देहरादून-248002  
कारपोरेटआईडी नं0: U40101UR2004GOI028675 दूरभाष नं0 0135-2646000 फैक्स नं0 0135-2643460 वेबसाइटwww.ptcul.org



पावर ट्रांसमिशन कारपोरेशन ऑफ उत्तराखण्ड लि0  
(उत्तराखण्ड सरकार का उपक्रम)  
अधीक्षण अभियन्ता (परीक्षण एवं परिचालन एवं स्काडा) कार्यालय  
कुमायु मण्डल हल्द्वानी  
मोबाइल नं0 9412089275, ईमेल dp\_singh@ptcul.org

			19. Anything which is left to be mentioned here but required for successful completion of the aforementioned subject work shall be done <b>Central Board of Irrigation and Power Malcha Marg Chanakyapuri, New Delhi-110021</b>
			20. CBIP Delhi shall submit a report on detailed points in four sets of hard copy duly spiraled binding as well as soft copy shall be submitted.
			21. The safety guidelines prevalent in PTCUL must be followed.
2	GST	:	GST shall be paid extra as per applicable Government rules.
3	Tax	:	Tax shall be deducted at source as per applicable Government rules. A certificate to this effect may be given to the Contractor if required.
4	Date of Start of work	:	Order shall be considered as having come in to force from the date of issue of order.
5	Supply Completion	:	NA
6	Work completion	:	The work should be completed within 24 months from the date of issue of order.
7	Engineer of the contract		Superintending Engineer (T&C), Haldwani is the "Engineer of the contract" who shall be placing the order for the work with the contractor and signing the contract agreement and who has been inherently vested with such powers by corporation in this behalf and shall act as Engineer for the purpose of the contract.
8	Engineer in-charge		Respective Executive Engineer (T&C) shall be "Engineer in charge" for the subject work.
9	Liquidity damages	:	If the contract is delayed beyond the stipulated period mentioned in the contract. The liquidity damages shall be levied @ 0.5 % per week and maximum up to 10% of contract value.
10	Dispute		All Dispute arising out of this case under the jurisdiction local court at Kashipur and Honable High Court, Nainital.
11	Payment terms	:	1. 25% Payment will be made within 30 days after finalization of Audit plan, subject to availability of funds from PTCUL HQ. 2. 35% Payment will be made within 30 days after submission of preliminary reports verified by Executive Engineer of respective division, subject to availability of funds from PTCUL HQ. 3. 40 % Payment will be made within 30 days after submission of final reports verified by Executive Engineer of respective division, subject to availability of funds from PTCUL HQ.
12	Payment unit		Test & Commissioning Division, Kashipur shall be the payment unit and all units where is to be work done shall record the measurement and duly passed bills along with measurement book shall be submitted to payment unit.
13	Warranty period	:	NA.
14	Billing Address	:	Executive Engineer Test & Commissioning Division, PTCUL 400 KV Substation Campus, Kashipur (Uttarakhand)-244713, GSTIN No. (05AAECM1785FC29)

All other term and condition of this order shall be governed by the General conditions of the contract prevalent in PTCUL.

(D.P Singh)

Superintending Engineer(T&C), Haldwani

मुख्यालय एवंपंजीकृत कार्यालय:-विद्युतमवन, नजदीक-आई0एस0बी0टी0 क्रासिंग, सहारनपुररोड, गाजरा, देहरादून-248002  
कारपोरेटआईडी नं0: U40101UR2004GOI028675 दरमारा नं0 0135-2646000 फौक्स नं0 0135-2643460 वेबसाइटwww.ptcul.org



पावर ट्रांसमिशन कारपोरेशन ऑफ उत्तराखण्ड लि०  
(उत्तराखण्ड सरकार का उपक्रम)  
अधीक्षण अभियन्ता (परीक्षण एवं परिचालन एवं स्काडा) कार्यालय  
कुमायु मण्डल हल्द्वानी  
मोबाइल नं० 9412089275, ईमेल dp\_singh@ptcul.org

No. 394 /SE (T&C)/PTCUL/ (H)/

Date:26.10.2023

Subject:- Corrigendum for the Order for the work of Protection Audit of 02 Nos 400 kV and 08 Nos 220KV sub-stations in  
PTCUL

Joint Advisor

Central Board of Irrigation and Power

Malcha Marg Chanakyapuri,

New Delhi-110021

Email: mrchauhan@cbip.org.

Dear Sir,

In reference to above mentioned subject, please refer to kick off meeting held on dated 26.10.2023 for the work of Protection Audit of 02 Nos 400 kV and 08 Nos 220KV sub-stations in PTCUL against order no.376 dated 29.09.2023.

In this regard, kindly find enclosed herewith corrigendum of order no.376 dated 29.09.2023 (Annexure-1) with necessary amendments as discussed in afforementioned meeting.

This is for your kind information and necessary action.

Please acknowledge the receipt and acceptance of order.

(D.P Singh)

Superintending Engineer (T&C), Haldwani

Copy forwarded to the following for information and necessary action:-

1. Chief Engineer, T&C PTCUL, 132kV Substation Campus, Kathgodam Nainital..
2. Executive Engineer, T&C Division, Roorkee/Dehradun/Haldwani/Kashipur/Rishikesh with request to provide assistance and information to CBIP for the above work.
3. Director (Energy), Central Board of Irrigation and Power Malcha Marg Chanakyapuri, New Delhi-110021  
Email: [sanjeev@cbip.org](mailto:sanjeev@cbip.org)

मुख्यालय एवंपंजीकृत कार्यालय:-विद्युतमवन, नजदीक-आई०एस०बी०टी० क्रॉसिंग, सहारनपुररोड, माजरा, देहरादून-248002  
कारपोरेटआईडी नं०: U40101UR2004GOI028675 दूरभाष नं० 0135-2646000 फैक्स नं० 0135-2643460 वेबसाइट [www.ptcul.org](http://www.ptcul.org)



Annexure -1 – Work order corrigendum

Scope: The detailed Scope work is as under:

S. No.	Clause of PO	Existing Clause					Modified Clause						
		Sr. No	Description	Unit	Qty	Amount	Total Amount	Sr. No	Description	Unit	Qty	Unit rate (Rs.)	Total Amount (Rs.)
1	Price Schedule	1	Protection Audit to be carried out for the following 10 nos. of the 400/220kV substations of PTCUL - 1. 400kV S/s Rishikesh 2. 400 KV S/s Kashipur 3. 220kV S/s Chamba 4. 220kV S/s Rishikesh 5. 220kV S/s Roorkee 6. 220kV S/s Haridwar (SIDCUL) 7. 220kV S/s Jhajra 8. 220 KV S/s Pantnagar 9. 220 KV S/s Haldwani 10. 220kV S/s Mahaukheragani. TOTAL	Job	1	36,25,000	36,25,000	1	Protection Audit to be carried out for the following 10 nos of the 400/220kV substations of PTCUL - 1. 400kV S/s Rishikesh 2. 400 KV S/s Kashipur 3. 220kV S/s Chamba 4. 220kV S/s Rishikesh 5. 220kV S/s Roorkee 6. 220kV S/s Haridwar (SIDCUL) 7. 220kV S/s Jhajra 8. 220 KV S/s Pantnagar 9. 220 KV S/s Haldwani 10. 220kV S/s Mahaukheragani) TOTAL	Each	10	3,62,500	36,25,000
2	Terms and Conditions S. No. 1 – Scope	<ol style="list-style-type: none"> <li>There must be a kick off meeting for discussion on project plan before start of the work in field and the detailed plan of performance shall be submitted by CBIP.</li> <li>Requisite data shall be collected in standard format from PTCUL grid substations by authorized and experienced auditor.</li> <li>The site surveys and audit of grid substations of PTCUL shall be done by authorized and experienced auditor.</li> <li>Review of the implemented protection schemes/ philosophy for 400/220 kV substations which includes protection of transmission lines, interconnecting transformers, line/bus reactors, bus bar, bus couplers etc with respect to</li> </ol>					<ol style="list-style-type: none"> <li>There must be a kick off meeting for discussion on project plan before start of the work in field and the detailed plan of performance shall be submitted by CBIP.</li> <li>Requisite data shall be collected in standard format from PTCUL grid substations by an experienced auditor.</li> <li>The site surveys and audit of grid substations of PTCUL shall be done by an experienced auditor.</li> <li>Review of the implemented protection schemes/philosophy for 400/220 kV substations which includes protection of transmission lines, interconnecting transformers, line/bus reactors, bus bar, bus couplers etc with respect to</li> </ol>						







S. No.	Clause of PO	Existing Clause	Modified Clause
		couplers etc.as per latest guidelines of Ramakrishna committee/CBIP/NRPC/international best practices, etc.	tripping in last one year as per latest guidelines of Ramakrishna committee/CBIP/NRPC/international best practices, which includes review of the following:
5.	Review the adequacy of primary and backup protection settings for protected equipment and suggest corrective measures where everyone compliance with respect to Ramakrishna committee/ CBIP/NRPC is found during the protection audit.	Review the healthiness/adequacy of 220/110/50V DC system available at substations for protection application.	a) Adequacy of primary and backup protection settings for protected equipment and suggest corrective measures b) Availability/healthiness of PLCC communication links used for protection systems.
6.	Review of availability/healthiness of PLCC communication links used for protection systems.	Review the healthiness/adequacy of 220/110/50V DC system available at substations for protection application.	c) Healthiness/adequacy of 220/110/50V DC system available at substations for protection application.
7.	Review of availability/healthiness of GPS system and time synchronization facility used for protection.	Review of availability/healthiness of recording instruments like DRs /ELs for transmission lines protection.	d) Availability/healthiness of GPS system and time synchronization facility used for protection.
8.	Review of availability/healthiness of recording instruments like DRs /ELs for transmission lines protection.	Review of test reports for assessing the healthiness of circuit breakers, CT & CVT based upon available test reports at sites.	e) Availability/healthiness of recording instruments like DRs /ELs for transmission lines protection.
9.	Review of test reports for assessing the healthiness of circuit breakers, CT & CVT based upon available test reports at sites.	Field inspection of protection device for obsolescence of technology, suitability and healthiness.	f) Test reports for assessing the healthiness of circuit breakers, CT & CVT based upon available test reports at sites.
10.	Field inspection of protection device for obsolescence of technology, suitability and healthiness.	Directory of the protection system & recommendation for replacement of obsolescence relays with compatible numerical relays will be provided.	g) Field inspection of protection device for obsolescence of technology, suitability and healthiness.
11.	Directory of the protection system & recommendation for replacement of obsolescence relays with compatible numerical relays will be provided.	Checking of availability of DG Set/auxiliary DC supply at substations.	h) Prepare recommendation for replacement of obsolescence relays with compatible numerical relays will be provided.
12.	Checking of availability of DG Set/auxiliary DC supply at substations.	Site visits for onsite protection audit, review and inspection of substations will be performed.	i) Checking of availability of DG Set / auxiliary DC supply at substations.
13.	Site visits for onsite protection audit, review and inspection of substations will be performed.	Submission of the detailed report for the protection audit including the protection philosophy, reviewed settings and protection audit observations.	5. Site visits for onsite protection audit, review and inspection of substations will be performed
14.	Submission of the detailed report for the protection audit including the protection philosophy, reviewed settings and protection audit observations.	The performance of above protection equipment like relays, circuit breaker, CT, CVT, DC battery bank, synchro facility, communication facility used for protection will be also checked through physical inspection and provided test reports/documents. These protection equipment's will be recommended for renovation and upgradation based on their performance accessed during protection audit and physical inspection.	6. Submission of the detailed report for the protection audit including the protection philosophy, reviewed settings and protection audit observations.
15.	The performance of above protection equipment like relays, circuit breaker, CT, CVT, DC battery bank, synchro facility, communication facility used for protection will be also checked through physical inspection and provided test reports/documents. These protection equipment's will be recommended for renovation and upgradation based on their performance accessed during protection audit and physical inspection.		Deleted as it is covered in point 4 above.







S. No.	Clause of PO	Existing Clause	Modified Clause
		<p>17. Review the availability healthiness of</p> <ul style="list-style-type: none"> <li>• Event recorders/ loggers' operation history</li> <li>• CT, CVT, CB</li> <li>• DC power supply</li> <li>• Auxiliary supply</li> <li>• Communication links</li> <li>• Time synchronization/ GPS</li> </ul> <p>18. Review of Testing and Maintenance records of all protective relays, Circuit Breakers, CT, CVT etc. Review of protection philosophy.</p> <p>19. Anything which is left to be mentioned here but required for successful completion of the aforementioned subject work shall be done Central Board of Irrigation and Power Malcha Marg Chanakyapuri, New Delhi-110021</p> <p>20. CBIP Delhi shall submit a report on detailed points in four sets of hard copy duly spiraled binding as well as soft copy shall be submitted.</p> <p>21. The safety guidelines prevalent in PTCUL must be followed.</p>	<p>7. Anything which is left to be mentioned here but required for successful completion of the aforementioned subject work shall be done by Central Board of Irrigation and Power.</p> <p>8. CBIP Delhi shall submit a protection report on detailed points in four sets of hard copy duly spiraled binding and in soft copy as well.</p> <p>9. The safety guidelines prevalent in PTCUL must be followed.</p>
3	Terms and Conditions – S. No. 6 - Work Completion	<p>The work should be completed within 24 months from the date of issue of order</p>	<p>The work should be completed within 24 weeks from the date of issue of corrigendum.</p>
4	Terms and Conditions – S. No. 8 - Engineer-in-charge	<p>Respective Executive Engineer (T&amp;C) shall be "Engineer in charge" for the subject work.</p>	<p>The following Executive Engineers (T&amp;C) shall be "Engineer in charge" for the subject work:</p> <p>a) 400KV Rishikesh, 220KV Rishikesh, 220 KV Chamba – Mr. Harsh Verma (Ph. No.9412074038 &amp; Email: ee_tandc_sh@ptcul.org).</p> <p>b) 400KV Kashipur, 220KV Pantnagar, 220KV Haldwani &amp; 220KV Mahuakheraganj – Mr. Asim Baig (Ph. No. 9412087885 &amp; Email: ee_tandc_asp@ptcul.org).</p> <p>c) 220KV SIDCUL Haridwar, 220 kv Roorkee – Mr. Ashwini Kumar (Ph. No.7088117301 &amp; Email: ee_tandc_ake@ptcul.org).</p> <p>d) 220KV Jhajra – Mr. Ravindra Kumar (Ph. No. 9927744222 &amp; Email: ee_tandc_ddun@ptcul.org).</p>





S. No.	Clause of PO	Existing Clause	Modified Clause
5	Terms and Conditions - S. No. 11 - Payment Terms	<ol style="list-style-type: none"> <li>1. 25% Payment will be made within 30 days after finalization of Audit plan, subject to availability of funds from PTCUL HQ.</li> <li>2. 35% Payment will be made within 30 days after submission of preliminary reports verified by Executive Engineer of respective division, subject to availability of funds from PTCUL HQ.</li> <li>3. 40 % Payment will be made within 30 days after submission of final reports verified by Executive Engineer of respective division, subject to availability of funds from PTCUL HQ.</li> </ol>	<ol style="list-style-type: none"> <li>1. 25% Payment will be made within 30 days after finalization of Audit plan, subject to availability of funds from PTCUL HQ.</li> <li>2. 35% Payment will be made within 30 days after submission of preliminary reports <b>on prorata basis</b> verified by Executive Engineer of respective division, subject to availability of funds from PTCUL HQ.</li> <li>3. 40 % Payment will be made within 30 days after submission of final reports <b>on prorata basis</b> verified by Executive Engineer of respective division, subject to availability of funds from PTCUL HQ.</li> <li>4. The local travel, lodging &amp; boarding shall be arranged by PTCUL on free-of-cost basis for CBIP team visiting the substation</li> </ol>







## **Annexure – 8: Data Sheets**



# Contents

<b>Single Line Diagrams</b> .....	59
<i>Substation Single Line Diagram</i> .....	59
<i>AC Auxiliary System</i> .....	60
<i>DC Auxiliary System</i> .....	61
<b>Transmission Lines</b> .....	64
<b>Bus-Bar Protection</b> .....	67
<b>AC Auxiliary System</b> .....	68
<b>DC Auxiliary System</b> .....	69
<b>Circuit Breakers</b> .....	70
<b>Current Transformer</b> .....	71
<b>Capacitive Voltage Transformer/Potential Transformer</b> .....	72
<b>Disturbance Recorder (DR) &amp; Event Logger (EL)</b> .....	73
<b>Communication System</b> .....	74
<b>Network Diagram of Uttarakhand</b> .....	75
<b>Power Map of Uttarakhand</b> .....	76

# Protection Audit of 400/220KV Rishikesh Substation

## Annexure - 8

### Data Sheets

## Single Line Diagrams

### Substation Single Line Diagram

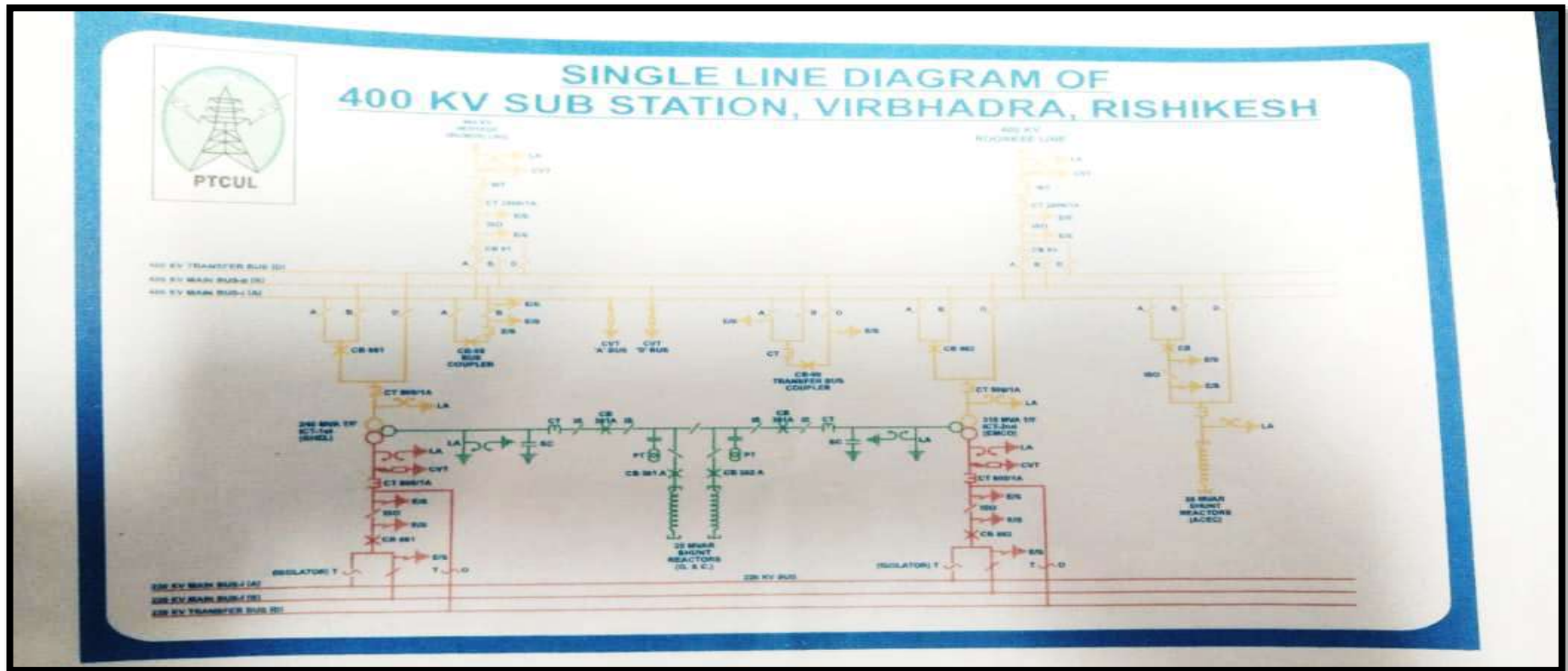

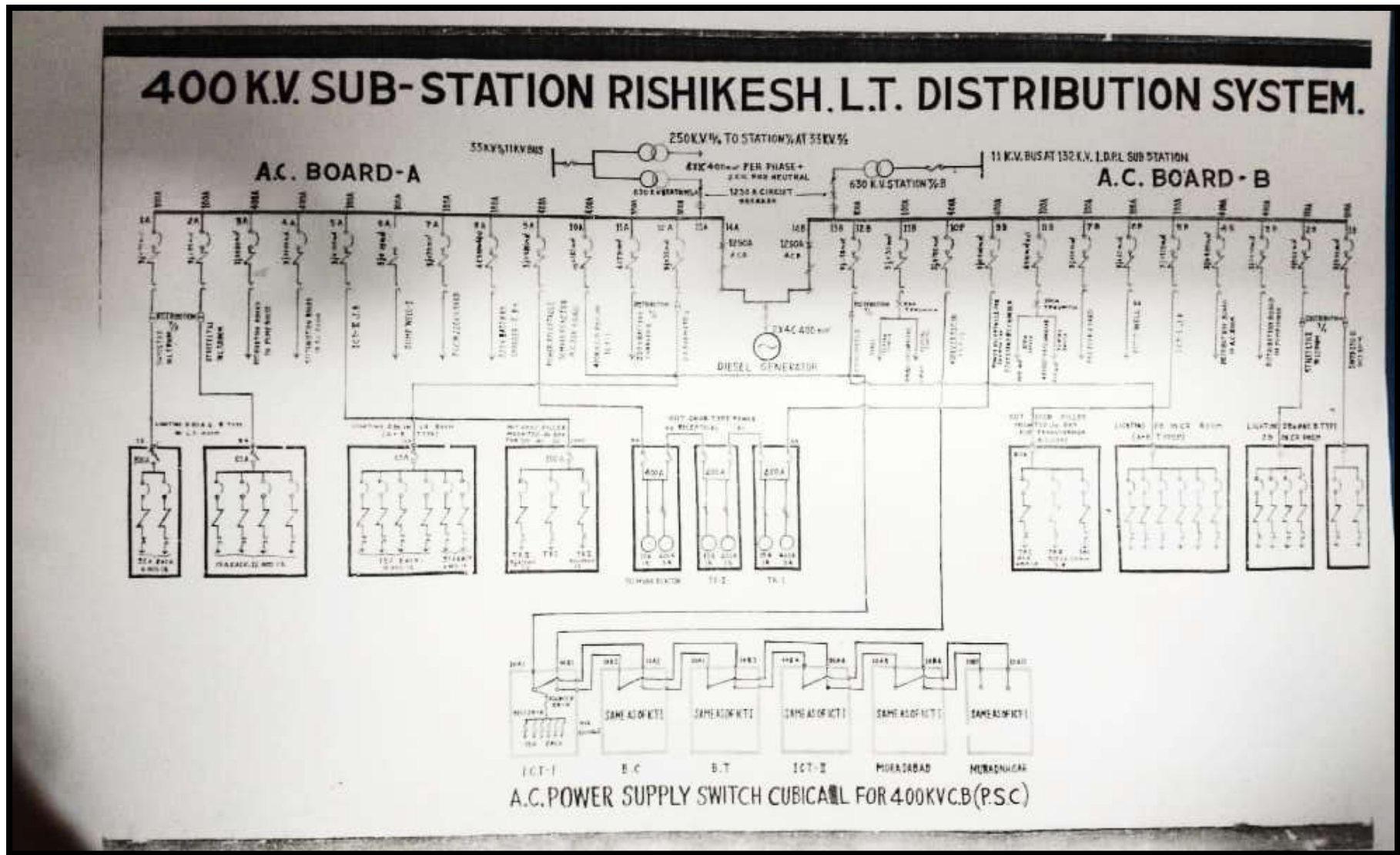

DC Auxiliary System

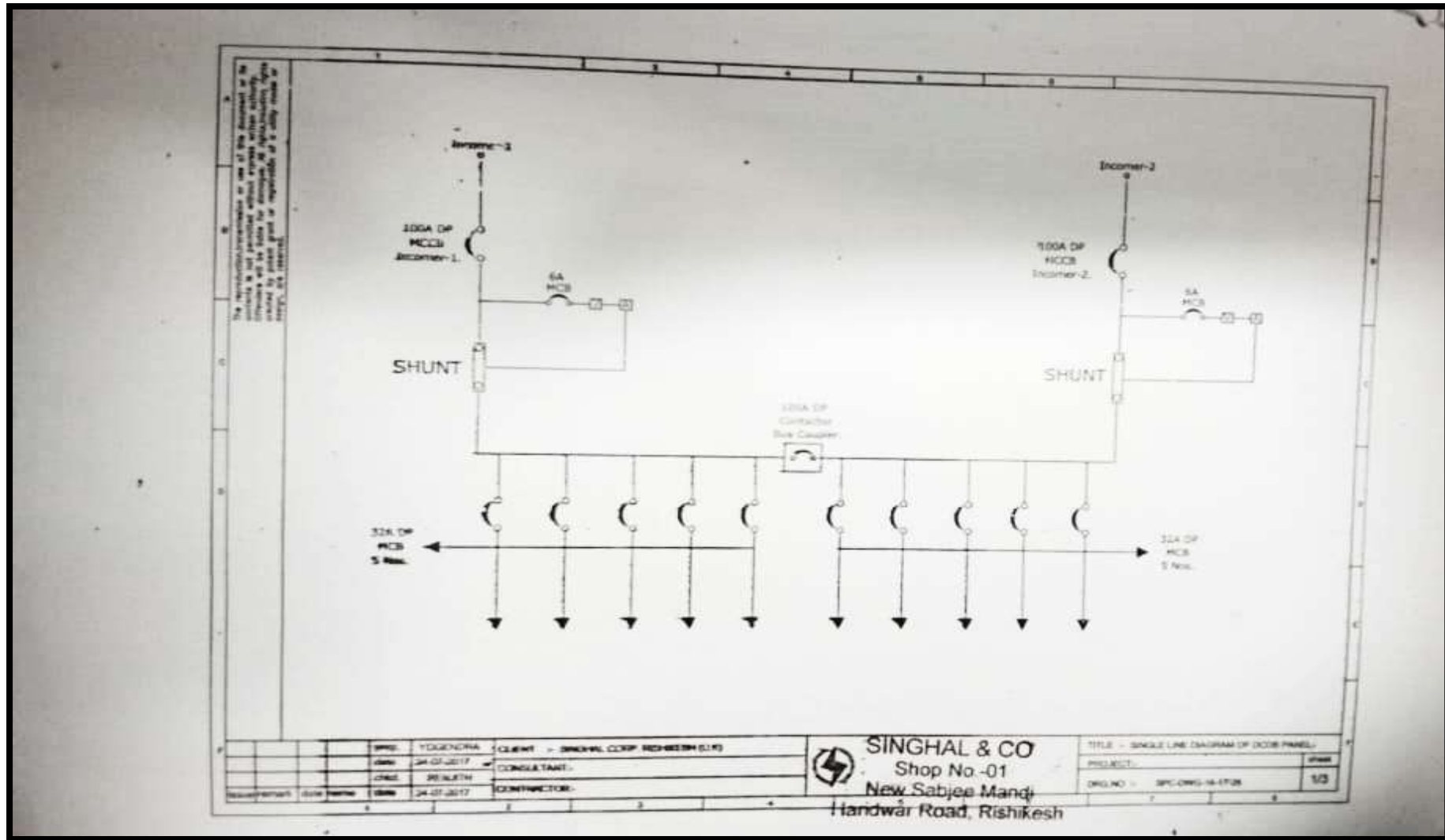

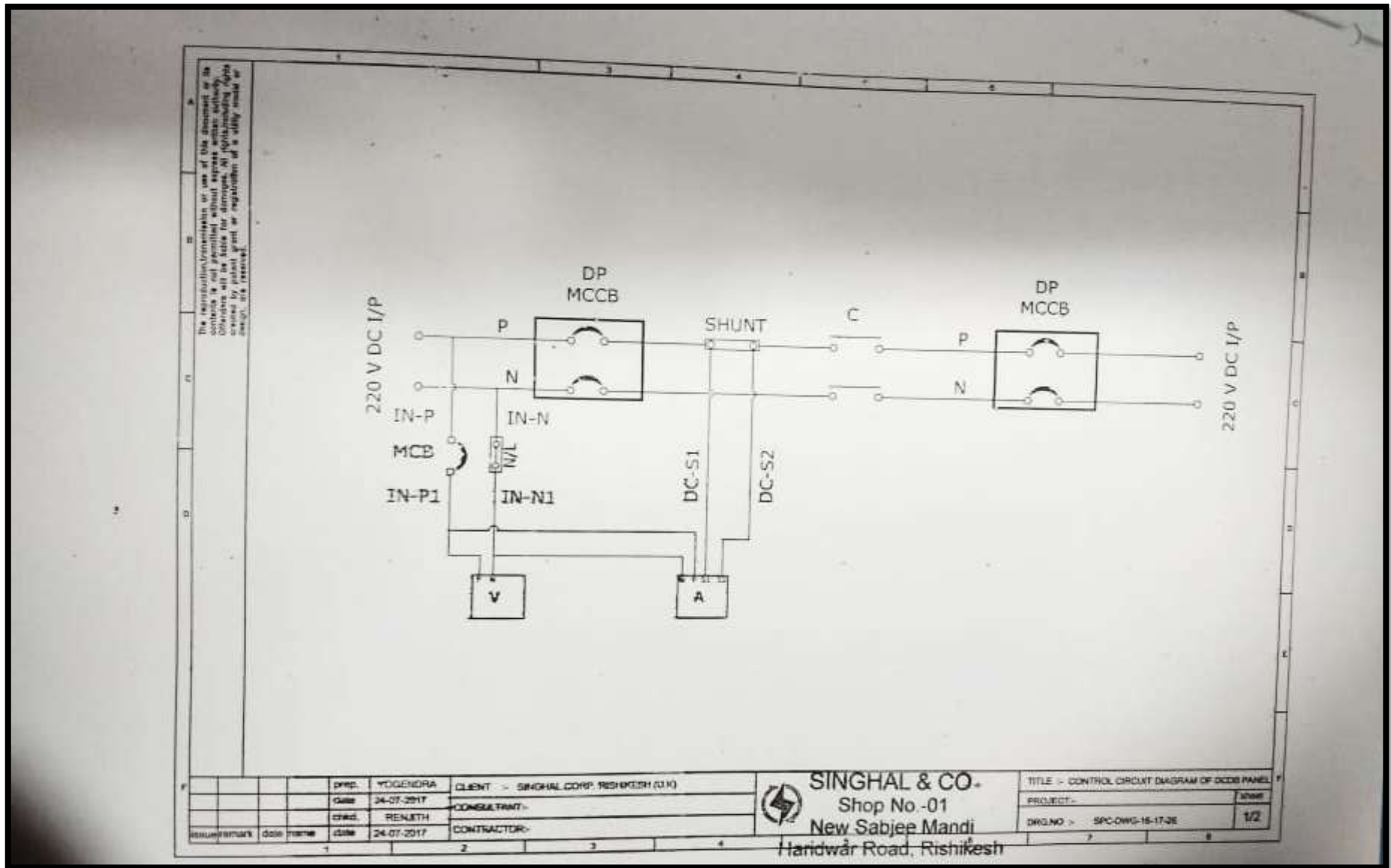

The reproduction, transmission or use of this document or its contents is not permitted without express written authority. All rights reserved. No responsibility is accepted by the author for any errors or omissions. All rights reserved.

PREP.	YOGENDRA	CLIENT >	SINGHAL CORP. RISHIKESH (U.I)	TITLE >	CONTROL CIRCUIT DIAGRAM OF MCCB PANEL
DATE	24-07-2017	CONSULTANT >		PROJECT >	
CHD.	RENJITH	CONTRACTOR >		DWG. NO >	SPC-OWG-16-17-2E
DATE	24-07-2017				1/2

**SINGHAL & CO.**  
 Shop No.-01  
 New Sabjee Mandi  
 Handwār Road, Rishikesh



SAS Architecture diagram

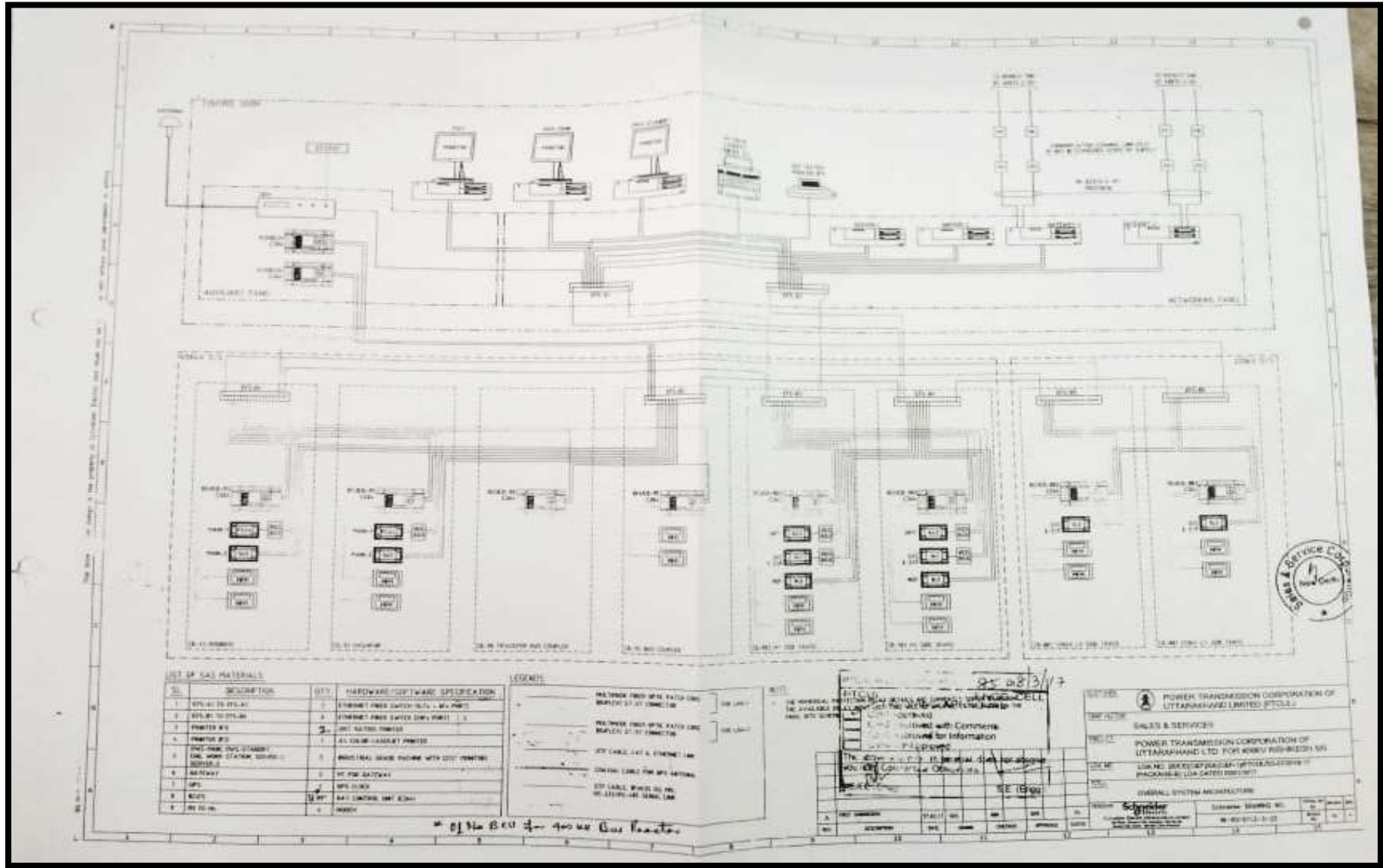

## Transmission Lines

### 400kV:

Particulars		Tr Line 1	Tr Line 2
Name of Tr Line		RKSH-NEHTOR	RKSH-PUHANA
Length of Line		89KM	50KM
Series Compensated (Yes/No)		NA	NA
Connected to dedicated CT core (mention name)		YES	YES
CT Ratio		2000/1	2000/1
Connected to dedicated PT core (mention name)		YES	YES
PT Ratio		400/110	400/110
Relay connected to Trip Coil-1 or 2 or both		BOTH	BOTH
Feed from DC supply-1 or 2		BOTH	BOTH
i	Main-I Protection (Make and Model)	P444	P442
	Functional (Yes/No)	YES	YES
	Date of testing	31.07.2023	17.08.2023
ii	Main-II Protection (Make and Model)	P141	P141
	Functional (Yes/No)	Y	Y

Particulars		Tr Line 1	Tr Line 2
	Date of testing	31.07.2023	17.08.2023
iii	LBB Protection (Make and Model)	INBUILT	INBUILT
	Functional (Yes/No)	Y	Y
	Date of testing	31.07.2023	17.08.2023
iv	PLCC/ Protection coupler (Make and Model)	NA	NA
	Functional (Yes/No)	NA	NA
v	DR (Make &Model) (Make and Model)	NA	NA
	Functional (Yes/No)	NA	NA
iv	Time Synch.Unit (Make and Model)	NA	NA
	Functional (Yes/No)	NA	NA
Other Protections			
1	Status of Power Swing	NA	NA
2	Out of Step	NA	NA
3	SOTF	Y	Y
4	Breaker Failure	Y	Y
5	Broken Conductor	NA	NA
6	STUB	Y	Y



Particulars		Tr Line 1	Tr Line 2
7	Fault Locator	NA	NA
8	Disturbance Recorder	Y	Y
9	VT fuse fail	Y	Y
10	Overvoltage Protection	Y	Y
11	Trip Circuit supervision	Y	Y
12	Auto-reclose	NA	NA
13	Load encroachment	NA	NA

**132kV: NA**

## Bus-Bar Protection

400kV

Sl. No.	Particulars	Observations
a	Busbar and redundant relay make and model	Siemens
b	Type of Busbar arrangement	Two main bus and Transfer
c	Zones	Three (Bus-1, Bus-2 and Check)
d	Dedicated CT core for each busbar protection	Yes
e	Breaker Failure relay included, if additional then furnish make and model	In case of any Breaker failure Relay Operating in sub-station, the relevant zone will be tripped
f	Trip issued to both Busbar protection in case of enabling	NA
g	Isolator indication and check relays	Particular bay indicates that
h	Other requirements for protection checking and validation	This Bus bar protection need to be tested

132 kV: NA

## AC Auxiliary System

Sl. No.	Particulars	Observations
a	Source of AC auxiliary system	02 nos. 630KVA Station transformers 11KV/0.4V
b	Supply changeover between sources (Auto/Manual)	Load is distributed between two transformers
c	Diesel generator (DG) details	Make- NA Rating-312.5KVA
d	Maintenance plan and supply changeover periodicity in DG	DG is not working. DG operation is negligible.
e	Single Line Diagram	To be attached
f	Other requirements for protection checking and validation	NA

## DC Auxiliary System

Sl. No.	Particulars	Observations			
		220 V DC - I	220 V DC - II	48 V DC-I	48 V DC-II
a	Make	Martin burn ltd	Statcon Electronics India Ltd.	M/s Kolkata Battery Supply Pvt ltd.	Nicco Corporation Ltd Noida
b	Model/Rating	400AH	400AH	500AH	300AH
c	Vintage				
d	Measured voltage				
	i. Positive to Earth	110	110	0	-48
	ii. Negative to Earth	-110	-110	0	-48
e	No. of Cells Per Bank	110	110	0	-48
f	Availability of Battery Charger	NA	NA	NA	NA

## Circuit Breakers

Sl. No.	Particulars	Make and Model	No. of trip/close coil	Trip Coil Supervision relay and healthiness of coils	LBB Setting Stage 1	LBB Setting Stage 2	Remarks (If any)
<b>A</b>	<b>400kV System</b>						
<b>1</b>	400kv line1	ABB/2009	2/1	YES	NA	NA	NA
<b>2</b>	Line2	CGL/2014	2/1	YES	NA	NA	NA
<b>3</b>	Transformers	CGL/2014	2/1	YES	NA	NA	NA

## Current Transformer

<b>a</b>	<b>Location of CT</b>	<b>400 KV LINE</b>				
<b>b</b>	Date of CT ratio Test Testing	LINE1-4-04-2023, LINE2- 21-09-2023				
		Core I	Core II	Core III	Core IV	Core V
<b>c</b>	Accuracy Class	PS	PS	0.2	PS	PS
<b>d</b>	Purpose	PROT.	PROT.	METERING	PROT	PROT
<b>e</b>	Test Results					
<b>i</b>	Ratio Adopted	2000/1	2000/1	2000/1	2000/1	2000/1
<b>ii</b>	Ratio measured	NA	NA	NA	NA	NA

<b>a</b>	<b>Location of CT</b>	<b>240MVA TF, 315MVA TF</b>				
<b>b</b>	Date of CT ratio Test Testing	ICT1-31-07-2023, ICT2- 17-08-2023				
		Core I	Core II	Core III	Core IV	Core V
<b>c</b>	Accuracy Class	PS	PS	0.2	PS	PS
<b>d</b>	Purpose	PROT.	PROT.	METERING	PROT	PROT
<b>e</b>	Test Results					
<b>i</b>	Ratio Adopted HV	2000/1	2000/1	500/1	500/1	500/1
<b>ii</b>	Ratio Adopted LV	800/1	800/1	800/1	800/1	800/1
<b>iii</b>	Ratio measured	NA	NA	NA	NA	NA

## Capacitive Voltage Transformer/Potential Transformer

<b>a</b>	<b>Location of CVT/PT</b>	<b>CVT</b>		
<b>b</b>	Date of CT/PT ratio Test Testing			
		Core I	Core II	Core III
<b>c</b>	Accuracy Class	PS	PS	0.2
<b>d</b>	Purpose	PROT.	PROT.	METERING
<b>e</b>	Test Results			
<b>I</b>	Ratio Adopted	400/110	400/110	400/110
<b>ii</b>	Ratio measured	NA	NA	NA

## Disturbance Recorder (DR) & Event Logger (EL)

Sl. No.	Particulars	400kV	132kV
1	a) Is the Disturbance recorder and Fault locator provided on all line feeders?	Yes	NA
	b) Whether standalone or built in Main relay	In built	NA
	c) Whether DR is having automatic fault record download facility to a central PC	Yes	NA
	d) Whether Central PC for DR, EL are powered by Inverter (fed from station DC)	Yes	NA
2	Whether substation is having Event logger facility	Yes	NA
	If Yes (standalone or built-in-SAS)	In Built	NA
3	Whether GPS based time synchronizing equipment is provided at the substation for time synchronizing of Main relays / DR/ Event logger / SAS/ PMU / Line Current Differential Relays	02(One for SAS and one for Relay)	



## Communication System

Sl. No.	Name of Line Feeder	PLCC/OPGW/none	If PLCC for protection(y/n)	Coupling type & no. Of channel	If opgw for protection(y/n)	Geographically distributed for main-1 & main-2 dedicated/multiplexed
1	RKSH-PUHANA	BOTH	YES	Ph-n /2	YES	Dedicated
2	RKSH-NAHTOUR	BOTH	YES	Ph-n/2	YES	Dedicated

# Network Diagram of Uttarakhand

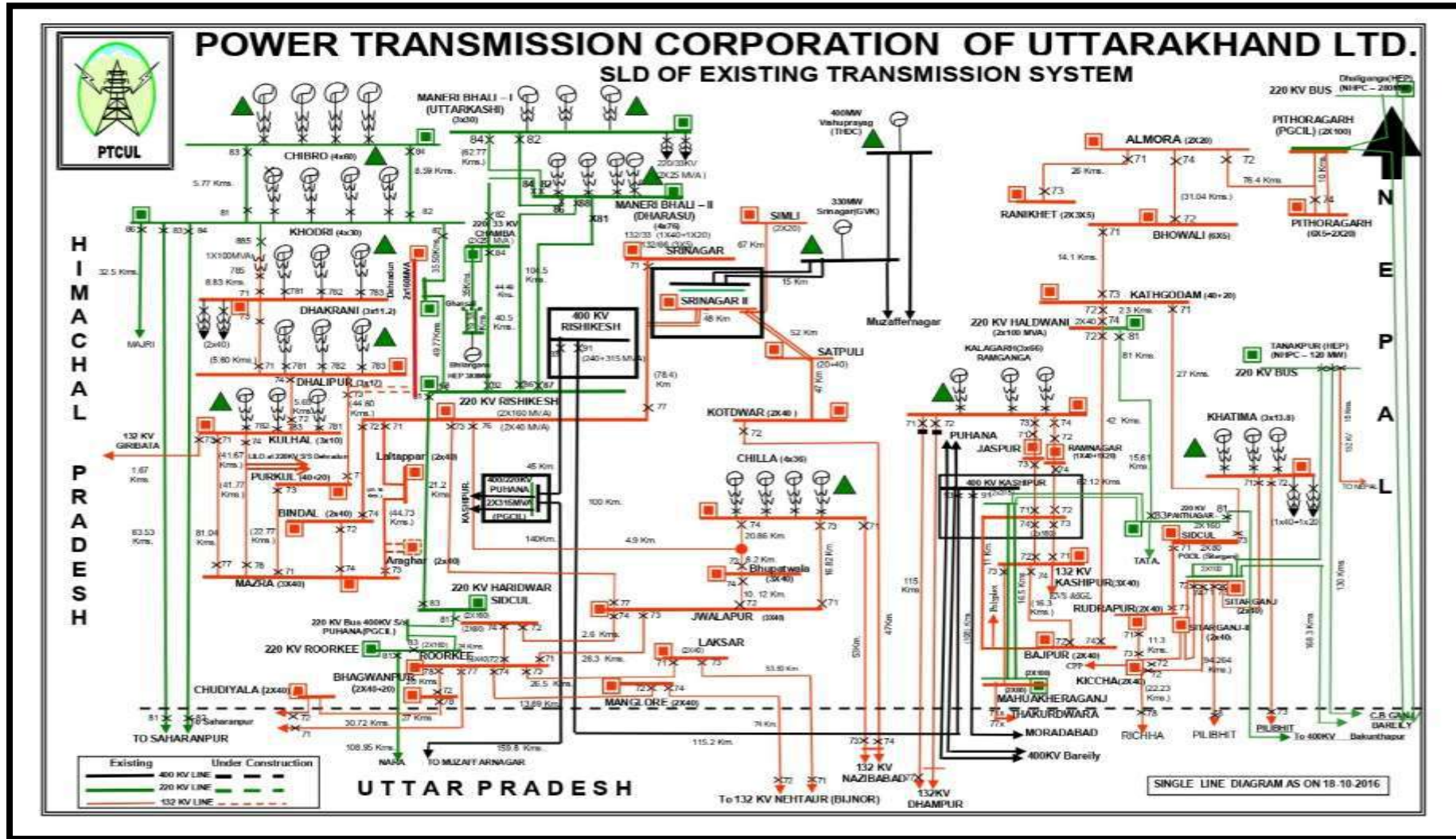

# Power Map of Uttarakhand

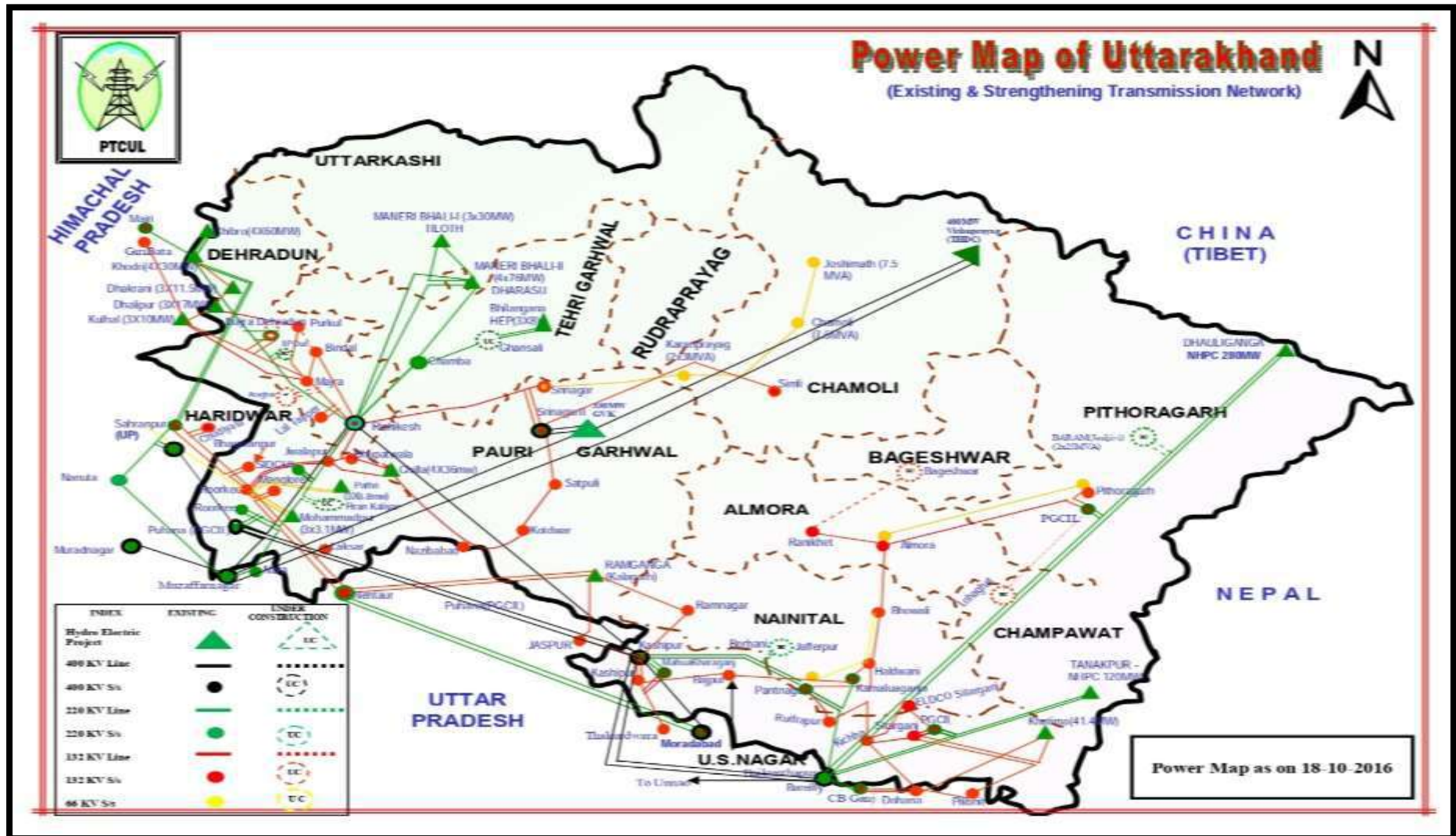



# **Power Transmission Corporation of Uttarakhand Limited**

(A Govt. of Uttarakhand Undertaking)

Corporate ID No.: U40101UR2004SGC028675

## **FINAL REPORT**

### **Protection Audit**

**220/132KV Rishikesh Substation**

**Submitted**

**By**



**CENTRAL BOARD OF IRRIGATION & POWER**

**NEW DELHI**





केन्द्रीय सिंचाई व शक्ति मंडल  
CENTRAL BOARD OF IRRIGATION AND POWER

25<sup>th</sup> June 2024

Order No.: 376/SE (T&C)/PTCUL/(H). dated: 29.09.2023

# Protection Audit Report

FINAL PROTECTION AUDIT REPORT OF 220/132/33 KV RISHIKESH SUBSTATION UNDER POWER TRANSMISSION CORPORATION OF UTTARAKHAND LIMITED (PTCUL), UTTARAKHAND.

Submitted  
To



**Power Transmission Corporation of Uttarakhand Limited**  
(A Govt. of Uttarakhand Undertaking)  
Corporate ID No.: U40101UR2004SGC028675

# Contents

<b>Disclaimer</b> .....	6
<b>1.0. Executive Summary</b> .....	7
<b>2.0. Introduction</b> .....	10
2.1. <i>Background</i> .....	10
2.2. <i>Scope of Work</i> .....	10
2.3. <i>Audit Rationale</i> .....	11
2.4. <i>Audit Process</i> .....	12
2.5. <i>About Power Transmission Corporation of Uttarakhand (PTCUL)</i> .....	14
2.6. <i>About Central Board of Irrigation &amp; Power (CBIP)</i> .....	15
<b>3.0. Preliminary Audit of 220KV Rishikesh Substation</b> .....	16
3.1. <i>General Information about Substation</i> .....	16
3.2. <i>Audit Team</i> .....	16
3.3. <i>Recommendation of last protection checking and validation</i> .....	17
3.4. <i>Review of existing settings at substation</i> .....	17
3.5. <i>Disturbance Recorder availability for the last 6 tripping's</i> .....	17
3.6. <i>Chronic reason of tripping, if any</i> .....	17
3.7. <i>Major non-conformity/deficiency observed</i> .....	17
<b>4.0. List of Trippings</b> .....	19
<b>5.0. Observations and Recommendations</b> .....	31
5.1. <i>Reporting of all the Tripping with DR/EL</i> .....	31
5.2. <i>Development of centralized database of relay settings</i> .....	31
5.3. <i>Review of test results of relay and equipment</i> .....	32
5.4. <i>Availability of Testing Kits</i> .....	32
5.5. <i>Up-dation of PTCUL Protection Philosophy</i> .....	32
5.6. <i>Simulation based study of protection system</i> .....	33
5.7. <i>Capacity Building of protection team</i> .....	33
5.8. <i>Updated Fault Level/ Short Circuit Level and Network information</i> .....	33
5.9. <i>General Protection related observations</i> .....	33
5.10. <i>O&amp;M Manual</i> .....	33
<b>6.0. Station Specific Observation and Recommendations</b> .....	34
6.1. <i>Protection related observations and recommendations</i> .....	34
6.2. <i>Equipment related observations and recommendations</i> .....	34
6.3. <i>Auxiliary Equipment related observations and recommendations</i> .....	35
<b>Annexure – 1: Suggested List of Testing Instruments</b> .....	36
<b>Annexure – 2: Suggested List of Substation Equipments</b> .....	37

<b>Annexure – 3: Suggested List of Maintenance Equipments.....</b>	<b>38</b>
<b>Annexure – 4: Protection Code (IEGC 2023 Chapter 4).....</b>	<b>39</b>
<b>Annexure – 5: Third Party Protection System Checking &amp; Validation Template for a Substation (IEGC 2023 Annexure – 1).....</b>	<b>44</b>
<b>Annexure – 6: Protection Philosophy/Protocol of Northern Region .....</b>	<b>49</b>
<b>Annexure – 7: Work Order &amp; Corrigendum.....</b>	<b>55</b>
<b>Annexure – 8: Data Sheets .....</b>	<b>63</b>

## ACRONYMS

<b>A</b>	Ampere
<b>AC</b>	Alternating Current
<b>AMP</b>	Annual Maintenance Plan
<b>CBIP</b>	Central Board of Irrigation and Power
<b>CT</b>	Current Transformer
<b>CVT</b>	Capacitive Voltage Transformer
<b>DC</b>	Direct Current
<b>DG</b>	Diesel Generator
<b>DPR</b>	Detailed Project Report
<b>DR</b>	Disturbance Recorder
<b>EL</b>	Event Logger
<b>EMTP</b>	Electromagnetic Transient Program
<b>EE</b>	Executive Engineer
<b>GPS</b>	Global Positioning System
<b>ICT</b>	Inter Connecting Transformer
<b>IEGC</b>	Indian Electricity Grid Code
<b>JE</b>	Junior Engineer
<b>KA</b>	Kilo Ampere
<b>KV</b>	Kilo Volt
<b>LBB</b>	Local Breaker Backup
<b>LEFT</b>	Earth Fault
<b>MVA</b>	Mega Volt Ampere
<b>NA</b>	Not Available
<b>NRPC</b>	Northern Regional Power Committee
<b>O&amp;M</b>	Operation & Maintenance
<b>OCC</b>	Operation Coordination Sub Committee



<b>PLCC</b>	Power Line Carrier Communication
<b>PSC</b>	Power System Sub Committee
<b>PSDF</b>	Power System Development Fund
<b>PT</b>	Potential Transformer
<b>PTCUL</b>	Power Transmission Corporation of Uttarakhand Limited.
<b>RLDC</b>	Regional Load Dispatch Centre
<b>RPC</b>	Regional Power Committee
<b>SAS</b>	Substation Automation System
<b>SE</b>	Superintendent Engineer
<b>SCADA</b>	Supervisory Control & Data Acquisition
<b>SLD</b>	Single Line Diagram
<b>SLDC</b>	State Load Dispatch Centre
<b>SOTF</b>	Switch On-To Fault
<b>SPS</b>	Special Protection Scheme
<b>T&amp;C</b>	Testing & Commissioning
<b>UJVNL</b>	Uttarakhand Jal Vidyut Nigam Ltd
<b>UPCL</b>	Uttarakhand Power Corporation Ltd
<b>WTI</b>	Winding Temperature Indicator

## Disclaimer

The protection audit has been carried out based on the guidelines provided under various documents mentioned in the report. For the purpose of audit, the auditor(s) have relied upon the data made available by the client and information & clarifications made available, in the written or verbal form, by the officials of clients during site visit and later.

The report is not for public distribution and has been furnished solely for information and must not be reproduced or redistributed to others, except those concerned. No one can use the report as a base for any claim, demand or cause of action and, also no one is responsible for any loss incurred based upon the content of this report.

While every effort is made to ensure the accuracy and completeness of information contained, CBIP takes no responsibility and assumes no liability for any error/ omission or accuracy of the information. Recipients of this material should rely on their own judgments and conclusions from relevant sources before taking any decision.

## 1.0. Executive Summary

PTCUL awarded the work of Third-Party Protection Audit of 2 nos. 400KV and 8 nos. 220KV sub-stations of PTCUL (“Utility”) to CBIP. CBIP planned the audit as per Audit process provided under Protection Code within Indian Electricity Grid Code 2023. In addition, the guidelines of Ramakrishna Committee for checking and validation and NRPC guidelines for Third Party Audit were also adhered too. The CBIP manual on protection (manual no 247-Revised), NRPC protection philosophy were also referred too.

As a part of audit process, utility was asked to provide set of information before start of audit. Team from CBIP consisting of Mr. Vijay Barthwal, Mr. M.R. Chauhan, Mr. Shivam Gupta & Mr. Avichal Pandey visited 220/132KV Rishikesh Substation during 19th – 21<sup>st</sup> February 2024 and preliminary audit report was submitted on the spot. The representatives of utility were present during this process. Some more information was sought from the Utility.

Based on the data made available by Utility, draft of final report was submitted to Utility and after discussions, report was finalized. The details of audit process, data made available by Utility, observations from preliminary report and detailed observations and recommendations are provided in this report. Key observations and recommendations are summarized below under 2 heads.

### **General Observations and Recommendations for Organization Level implementation**

01. It is recommended that each substation to have a central repository for tripping reports, along with Time Synchronized DR/EL reports and analysis. A dedicated PC can be provided at each substation for the purpose.
02. The protection philosophy adopted by Utility, in general, is in alignment with protection philosophy adopted by NRPC. As the NRPC has recently updated the protection philosophy, PTCUL in consultation with SLDC may update protection philosophy for network not covered by NRPC too, if needed, and implement the same.
03. It is recommended that latest recommended relay settings, as per the NRPC protocol for 220KV & above Substations, along with setting calculations & parameters used for all the relays, be kept at each substation. This will help in proper fault analysis and ascertaining relay healthiness. Similarly, Relay settings for sub-stations below 220KV, based on any such protocol by SLDC, along with setting calculations and line parameters also needs to be maintained.
04. It is recommended that the detailed reports of test results for the relays and switchyard equipments be maintained at sub-station level.

05. Based on “Draft O&M Manual” of PTCUL and discussions with their officials, a list of testing equipment is suggested and enclosed at Annexure - 1. Also, a list of switchyard maintenance equipment is placed at annexure -3. It is recommended that the necessary testing and maintenance equipment at substation/Sub-division/Division be arranged for regular testing and maintenance of equipment at substations.
06. Simulation based studies or EMTP Studies should be carried out by the Utility, as per the requirement of IEGC-2023.
07. For the protection system and SAS, PTCUL may undertake capacity building exercise for the officials involved in these activities.
08. It is recommended that the updated network information and short circuit level should be periodically reviewed and maintained at central level for revising the setting as per requirement.
09. It is suggested that utility may carry out exhaustive safety and technical audit of sub-stations apart from protection audit, either internally or thru’ third party for implementing the best practices in the sub-station.
10. It is suggested that the existing draft O&M manual be updated to take care of latest developments.

#### **Observations and Recommendations for 220/132KV Rishikesh Substation**

- 1.0. The Protection audit is carried out for the first time. The SLD includes the adjoining 132/33/11KV IDPL sub-station, but the station is managed separately and not integrated with SAS. Accordingly, 132/33/11KV sub-station is not covered under present audit.
- 2.0. 220KV bus-bar protection is not provided and procurement process is initiated. It is recommended to expedite the process.
- 3.0. One single breaker is provided for Bus-coupler and Transfer Bus Coupler function, therefore, both buses are hard coupled thru isolators and backup over current and earth fault protection is provided for this breaker. It is suggested that this operation philosophy be reviewed at the time of designing/commissioning of bus-bar protection.
- 4.0. For 220KV Dharashu line II and 220KV SIDCUL Line, the back-up protection needs to be replaced with distance protection, in line with protection philosophy.
- 5.0. 220KV side of 400/220KV Transformer are not connected through Transfer Bus. It is suggested to explore the possibility of connecting them thru Transfer bus.
- 6.0. 132 KV BINDAL line BCU is not working. This needs to be rectified.
- 7.0. It is recommended to update/Upgrade the SAS to include the missing inputs.

- 8.0. The SAS GUI time is not synchronised and displays time different from GPS. It is suggested to take necessary remedial measures for the same.
- 9.0. The 110V DC system is designed for single source. 2 nos. of 110V DC systems are provided. IT is suggested that PTCUL examines the possibility of dual source DC supply to protection system.
- 10.0. Emergency DG set operation is not operational. It is recommended to keep the DG set in operation.

## 2.0. Introduction

### 2.1. Background

The work has been awarded to the Central Board of Irrigation & Power (CBIP) vide Work Order Number: 376/SE (T&C)/PTCUL/(H), dated: 29.09.2023 for Protection Audit of 02 Nos. 400 KV and 08 Nos. 220 KV Sub-Stations at Uttarakhand, for Power Transmission Corporation of Uttarakhand Limited (PTCUL) in reference to the offer submitted by CBIP to PTCUL vide ref. no. P-1/CBIP/PTCUL/Audit/2023, dated: 11.09.2023. A Kick-Off Meeting was held between PTCUL and CBIP at the office of SE (T&C), PTCUL, Kathgodam, Haldwani on 26<sup>th</sup> October 2023. Detailed discussions were held regarding process and methodology of Execution and Submission of reports of Protection Audit. As per the above-mentioned meeting, a corrigendum was released by PTCUL vide ref. no. 394/SE (T&C)/PTCUL/(H), dated: 26.10.2023.

**As per the given order, the protection audit of following sub-stations is to be carried out**

1. *400kV Rishikesh*
2. *400kV Kashipur*
3. *220kV Chamba*
4. *220kV Rishikesh*
5. *220kV Roorkee*
6. *220kV Haridwar (SIDCUL)*
7. *220kV Jhajra*
8. *220kV Pantnagar*
9. *220kV Haldwani*
10. *220kV Mahuakheraganj*

### 2.2. Scope of Work

Review of the implemented protection schemes/philosophy for 400/220 kV substations which includes protection of transmission lines, interconnecting transformers, line/bus reactors, bus bar, bus couplers etc. with respect to tripping in last one year as per latest guidelines of Ramakrishna committee/ CBIP/NRPC/International best practices, which includes review of the following:

- a. *Adequacy of primary and backup protection settings for protected equipment and suggest corrective measures.*
- b. *Availability/healthiness of PLCC communication links used for protection systems.*
- c. *Healthiness/adequacy of 220/110/50V DC system available at substations for protection application.*
- d. *Availability/healthiness of GPS system and time synchronization facility used for protection.*
- e. *Availability/healthiness of recording instruments like DRs /ELs for transmission lines protection.*
- f. *Test reports for assessing the healthiness of circuit breakers, CT & CVT based upon available test reports at sites.*
- g. *Field inspection of protection device for obsolescence of technology, suitability and healthiness.*
- h. *Prepare recommendation for replacement of obsolescence relays with compatible numerical relays will be provided.*
- i. *Checking of availability of DG Set / auxiliary DC supply at substations.*

### **2.3. Audit Rationale**

- a. PTCUL (Utility) has submitted a DPR for Replacement of certain equipment under PSDF scheme to Grid-India. Grid-India has asked PTCUL to carry out protection audit of certain substations.
- b. In addition, as per CERC IEGC 2023 Chapter-04 (Protection Code) Para - 15 (2) “All users shall also conduct third party protection audit of each substation at 220KV and above (132KV and above in NER) once in 5 years or earlier as advised by the respective RPC”.
- c. As per Para – 15 (4) of said Code, “The third-party protection audit report shall contain information sought in the format enclosed as Annexure–1. The protection audit reports, along with action plan for rectification of deficiencies detected, if any, shall be submitted to the respective RPC and RLDC or SLDC, as the case may be, within a month of submission of third-party audit report. The necessary compliance to such protection audit report shall be followed up regularly in the respective RPC”.
- d. Subsequently NRPC issued protection philosophy for Northern region developed in compliance of IEGC 2023, Version 2.0 which was approved in 71<sup>st</sup> NRPC meeting held on 29.01.2024. Accordingly, protection audit of 220KV and above Substations is being carried out by CBIP, as per Annexure -1 of IEGC-2023.

## 2.4. Audit Process

- PTCUL shall provide the following documents:
  - a. The Network Diagram, covering the relevant assets
  - b. Latest relay settings adopted and calculations for respective sub-stations and transmission lines.
  - c. Annual maintenance plan (AMP), including the schedule and activities covered under AMP
  - d. Any specific issues covered under OCC and/or PSC of NRPC for relevant assets.
- For each sub-station, check-list shall be provided by PTCUL. During field visit, the information shall be verified.
- The minimum set of points on which checking and validation shall be carried out is provided as per annexure - 4 for the following available power system elements at station, as per attached formats:

Sl. No.	Elements
1	Transmission Line
2	Bus Reactor/Line Reactor
3	Inter-connecting Transformer
4	Busbar
5	AC auxiliary system
6	DC auxiliary system
7	Communication system
8	Circuit Breaker Details
9	Current Transformer Details
10	Capacitive Voltage Transformers Details
11	Any other equipment/system relevant for protection system operation

- During field visit, no testing of equipment and relay shall be carried out. The visual inspection, operational log shall be considered for audit purpose, apart from the documents provided by PTCUL.



- A calibrated multi-meter shall be provided at sub-station for checking AC and DC voltages and currents online, wherever feasible, without impacting the sub-station operations.
- The preliminary report shall be prepared on the site and shall be signed by all the parties present, as given below:

S. No.	Issues	Remarks
1	Recommendation of last protection checking and validation	Status of works and pending issues if any
2	Review of existing settings at substation	Recommended Action
3	Disturbance Recorder out/ available for last 6 tripping's (Y/N)	Recommended Action
4	Chronic reason of tripping, if any	Recommended Action
5	Major non-conformity/deficiency observed	Recommended Action

- **The Final summary shall specifically mention minimum following points:**
  - The settings and scheme adopted are in line with agreed protection philosophy or any accepted guidelines (e.g., Ramakrishna guidelines or CBIP manual based).
  - The deviations from the RPC protection philosophy, if any and reasons for taking the deviations shall be recorded.
  - All the major general deficiency shall be listed in detail along with remedial recommendations.
  - The cases of protection maloperation (last 1 year) shall be analysed from tripping reports and the causes of failure along with corrective actions and recommendations based on the findings.

## ***2.5. About Power Transmission Corporation of Uttarakhand (PTCUL)***

The State of Uttarakhand's power transmission utility, PTCUL, was formerly known as Uttaranchal. According to the Uttar Pradesh State Reorganization Act 2000, this 27<sup>th</sup> state of the republic of India was formed on November 9, 2000, by dividing the Himalayan and surrounding North-Western districts of Uttar Pradesh.

The State of Uttaranchal in exercise of the power granted to it under section 63(4) of the State Re-Organization Act, 2000, formed two separate companies in power sector:

- Uttaranchal Jal Vidyut Nigam Ltd. (UJVNL) – For generation of Hydro-Electricity in the State.
- Uttaranchal Power Corporation Ltd. (UPCL) – For Transmission and Distribution of Electricity in the state.

Enactment of the Electricity Act 2003, a distinct watershed in the Indian Power Sector, made it mandatory for all the States to restructure their SEBs. As per the provisions of Electricity Act 2003, the State Government separated power transmission business from UPCL which was left only with distribution of electricity.

In order to manage Power Transmission Operations, a new company called Power Transmission Corporation of Uttaranchal Ltd. was established. On 27<sup>th</sup> May, 2004, the firm was formed as a Government Company in accordance with section 617 of the Companies Act, 1956. It began operating from 1<sup>st</sup> June, 2004.

The company's corporate and registered office is located in Vidyut Bhawan, Saharanpur Road, Majra, Dehradun, next to the ISBT Crossing.

## ***2.6. About Central Board of Irrigation & Power (CBIP)***

The Government of India established the Central Board of Irrigation and Power in 1927, making it a Premier Institution. For the past 93 years, CBIP has provided committed services to the nation's professional associations, engineers, and individuals involved in the power, water resources, and renewable energy sectors. While serving the country equally and to great honour, CBIP has developed into an esteemed institution of international significance. CBIP is Indian chapter for 10 international organizations related to Power & Water resources sectors.

CBIP is involved in executing various activities such as, International Conferences, Technical Documents Publications, Training Activities, Research & Development, Consultancy Services including Technical, Protection & Safety Audits.

### 3.0. Preliminary Audit of 220KV Rishikesh Substation

#### 3.1. General Information about Substation

Sl. No.	Particulars	Details
1	Substation Name	220/132/33 kV Rishikesh Substation
2	Name of Owner Utility	Power Transmission Corporation of Uttarakhand Limited (PTCUL)
3	Voltage Level (s) or highest voltage level	220/132/33KV
4	Short circuit current rating of all equipment (for all voltage level)	220KV = 40KA/sec, 132KV = 40KA/sec 33KV = 25KA/sec
5	Date of commissioning of the substation	12 <sup>th</sup> December 1974
6	Checking and validation date	19 <sup>th</sup> – 21 <sup>st</sup> February 2024

#### 3.2. Audit Team

##### Audit Team (CBIP):

- Mr. Vijay Barthwal
- Mr. M.R. Chauhan
- Mr. Shivam Gupta
- Mr. Avichal Pandey

##### PTCUL Representative:

- Er. Harsh Verma, Executive Engineer (T&C)
- Er. Manoj Bahuguna, Executive Engineer (O&M)
- Er. Pankaj Kailkura, Assistant Engineer (T&C)
- Er. Ajit Pal, Assistant Engineer (O&M)

### ***3.3. Recommendation of last protection checking and validation***

The Protection Audit of 220/132KV and 132/33KV is done for the first time.

### ***3.4. Review of existing settings at substation***

- a. Utility has provided relay settings adopted for various feeders and transformers.
- b. The record of different relay setting calculations is not available at the substation level.
- c. All relays are numeric, therefore, as per internal protocol of utility relays are tested only at the time of commissioning/change in setting. Copy of test reports not available at substation level.

### ***3.5. Disturbance Recorder availability for the last 6 tripping's***

- a. No separate DR/ EL is provided. The DR and EL data are taken from individual numerical relays and SAS.
- b. The inputs from DR reports from numerical relays are available in the server and can be downloaded using LAN cable.
- c. For each tripping data is sent to head office for records.
- d. The Utility has shown data for last 6 trippings.

### ***3.6. Chronic reason of tripping, if any***

- a. The S/S has five 220 kV lines, five 132 kV lines and Four Transformers. Total 44 trippings during the last year were observed, most if which are either Transient E/F or Overloading
- b. No chronic/ severe trippings are observed.

### ***3.7. Major non-conformity/deficiency observed***

- a. The SAS is working partially, some analog and digital signal are not appearing.
- b. For 220 kV, Bus Bar Protection is available but not in use due to being obsolete and defective. Currently, the Zone 4 settings are kept at 0.25 secs in Reverse Zone. The process for procurement has been initiated.
- c. Bus Bar Protection for 132 kV is not provided. SAS System needs to be upgradation/ updation.

- d. 132 kV switchyard is provided with double Main and Transfer Bus scheme For Bus Coupler and TBC single breaker is provided and therefore TBC is used as Bus Coupler also.
- e. Both the Main Buses are hard coupled using two isolators (A and B) of Main Bus. Buses can also be coupled through the TBC breakers, for that O/C +E/F relay is provided for protection.
- f. 220 kV switchyard is provided with double Main and Transfer Bus scheme For Bus Coupler and TBC single breaker is provided and therefore TBC is used as Bus Coupler also.
- g. Both the Main Buses are hard coupled using two isolators (A and B) of TBC. Buses can also be coupled through the TBC breakers, for that O/C +E/F relay is provided for protection.
- h. The whole system is designed for single DC source; therefore, both the DC system cater to different relays and systems.
- i. 220 kV side of 400/220 kV Transformer are not connected through Transfer Bus.
- j. For 220 kV Dharashu II, Micom P442 is provided as distance protection. In addition, Siemens 7SJ62 is provided as back up O/C + E/F Protection. This need to be replaced.
- k. For 220 kV SIDCUL, Micom P444 is provided as distance protection. In addition, relay Siemens 7SJ62 is provided as back up O/C + E/F Protection. This need to be replaced.
- l. Auto reclose is kept blocked for IIP feeder and Dharashu I feeder.
- m. 132 kV BINDAL line BCU is not working, 220 /132 kV ICT 3 has been removed but BCU is ok.
- n. All the relays and SAS are time synchronised. However, the GUI for SAS is taking time display from Windows OS of individual PC therefore regular time updation of Windows OS server need to be done.
- o. Auxiliary Supply is provided from two sourced:
  - i. 132 kV IDPL S/S.
  - ii. 33 kV IDPL S/S.
- p. No standby DG set is provided.
- q. 2 nos 110 V DC auxiliary supply is provided and no earth fault is noticed
- r. Two 48V DC system is provided.
- s. The SLD shows the adjoining 132 kV IDPL S/S. However, same is not managed by 220/132 kV Rishikesh Control room. Accordingly, it not integrated with SAS.

## 4.0. List of Trippings

Name of Feeder/TF	Type of Relay / Scheme	Date & Time of Tripping	Date& Time of closing	Flags observed	Other end flage	Tripping Analysis / Action taken report	Category Code	Action Taken
220 KV Rishikesh-Dharashu I	Siemens Siprotec	05-01-23 15:50 hrs	05-01-23 20:47 hrs	C.P. : main I ,main II dist. Prot operated R.P. : Gen trip , O/C Pick up L3 on , dist. Trip 3 P on, definite trip on , zone 2 operated , fault location= 72.80 km IL1= 0.03 Kamp IL2= 0.03 Kamp IL3= 2.01 Kamp 3 phase trip relay 863A, 863B	line under S/D by maintenance work at 220 KV S/S Rishikesh from 11:44 hrs line S/D return & try given from 220 KV S/S Rishikesh end at 15:50 hrs	Dharshu power House Line B phase lightning arrester brust	LHWT	faulty L.A. Replace by Dharashu power house Concern person's
Rishikesh-Dharashu I (79Km)	Siemens Siprotec	09-01-2023 13:29 hrs	09-01-23 13:54 hrs	C.P. : main I ,main II dist. Prot operated R.P. : Gen trip , O/C Pick up L2 on , dist. Trip 3 P on, definite trip on , zone 2 operated , fault location= 78.90 km IL1= 0.22 Kamp IL2= 1.92 Kamp IL3= 0.52 Kamp 3 phase trip relay 863A, 863B	at Dharashu power house Generation machine trip,220 Kv tiloth-dharashu line's trip on Tiloth power house end grid supply fault at Dharashu power house ( no tripping at dharashu-rishikesh line at dharashu power house end)	according to dharashu power house shift persons heavy spark observed at 220 KV Bus of dharashu power house	LEFT	NA
220 KV Rishikesh-Dharashu II	Micom P444	09-01-2023 13:29 hrs	09-01-23 13:55 hrs	C.P. : DPS , DPT R.P. : Gen trip , start pahse B-N, triap phase ABC , Distance start, distance trip zone 2 , fault location=79.20 km ia=473A Ib=2.08Ka Ic=503A van=123Kv Vbn=97Kv Vcn=124Kv trip relay 86				
220 KV Rksh-Dharashu I	Siemens	22-01-2023 14:56 hrs	22-01-2023 15:16 hrs	C.P. : Main 1, Main 2 prot.optd. R.P. : Gen trip , start phase L2, I>> on , definite trip on , dist. Trip 3 P on , fault loop L2-E, fault location =23.60 km	Dist. Trip zone 1 , fault loop L2-E, fault location= 52.60 Km	Transiesnt Line fault	LEFT Y phase-Earth fault	Line patrolling required inform concern persons

Name of Feeder/TF	Type of Relay / Scheme	Date & Time of Tripping	Date& Time of closing	Flags observed	Other end flag	Tripping Analysis / Action taken report	Category Code	Action Taken
				IL1= 0.04 Ka IL2=4.24Ka IL3=0.02 Ka 3phase trip relay 863A, 863B				
132 KV Rishikesh-Bindal Line	ABB REL 511	14-02-23 14:45 hrs	14-02-23 15:55 hrs	C.P. : DPS ,DPT, Final trip R.P. : Gen trip , O/C pick up L1, TOC-STL1, STN , zone 2 start, zone 2 trip , IL1=2367A IL2=215A IL3=512A In=1669 A Van= 66.40 Kv Vbn= 75.60 kV Vcn= 75.75 kV	R phase pick up, zone 1 trip , fault location = 5.81 km Ia= 4.11 ka Ib= 227 A Ic= 512A Van=24 kv Vbn=81.65 kV Vcn=79.18 kV	according to concern line person's steel wire peace was struck on line ( by bird)	LEFT	line patrolling done by concern line staff
160 MVA T/F-1 220/132 KV (BHEL make)	Diff. Prot. Micom P643	03-03-2023 16:11 hrs	03-03-2023 21:55hrs	C.P. : Diff. Prot. Operated R.P. : Active group 1, Diif. Prot. Start, Diff. Prot. Trip, relay trip time=0.00 s IA1=163 A IB1=267A IC1=12.73 Kamp IA3=508A IB3=84A IC3=2.53 Kamp Iadiff=11.45pu Ib=11.49 Icdiff=22.94pu Iabias=5.74 Ib=5.75 Icbias=11.47 pu tripping relay 86	NA	T/F 220 KV Side B phase Lightning arrester fail	SEFT	Defected Lightning Arrester & surge counter replaced by O&M concern person
132 KV Rksh-Dharashu-I	Siemens	12-03-2023 17:38 hrs	12-03-2023 17:53 hrs	C.P. : Main 1,main 2 prot. Optd. R.P.: Gen trip , O/C start L1 on , A/R lock , def. Trip on , dist. Trip 3 P on, zone-1 trip IL1= 2.24 Ka IL2= 0.26 Ka IL3=0.27Ka fault location =60.60 km tripping relay 863A,863B	Gen trip , zone 1 trip, O/C pick up L1 on , fault location= 15.90 km	Bad weather	LEFT	Line patrolling required inform concern person's 220 KV Chamba
132 KV Rksh-	Micom P442	14-03-2023 16:04 hrs	14-03-2023 16:14 hrs	C.P. : DPS, DPT, R.P. : Active group 1 ,start phase A-N , A/R lock , trip phase ABC, Dist. Trip	Disc Pick up L1-E, R phase pick up , zone 1 trip ,	Bad weather	LEFT	Line patrolling required inform to concern person's 220



Name of Feeder/TF	Type of Relay / Scheme	Date & Time of Tripping	Date& Time of closing	Flags observed	Other end flag	Tripping Analysis / Action taken report	Category Code	Action Taken
				zone-1 , Fault location= 50.75 km Ia=2.57 Kamp Ib=186A Ic=57 A Van=96Kv Vbn=128Kv Vcn= 127 Kv tripping relay 86				KV S/S Chamba
132 KV Rksh-Dharashu-I	Siemens	19-03-2023 16:03 hrs	19-03-2023 17:29 hrs	C.P. : main 1,main 2 prot. Optd. R.P. : Gen trip , O/C pick up L3 on , dis pick up 3p on, A/R lock , definite trip on , zone 1 trip , IL1=0.13 Ka IL2=0.13Ka IL3=5.29Ka fault location= 21.90 km tripping relay 86,863	Gen trip , Dis pick up L3-E, zone1 trip , fault location=54.10 km IL3= 1.20 Ka	Bad weather (Transient Line fault)	LEFT	Line patrolling required inform concern line persons 220 KV S/S Chamba
132 KV Bindal	Distance relay ABB REL 511	24-03-2023 19:33 hrs	24-03-2023 19:53 hrs	C.P. : DPS , DPT , Final trip R.P. : Gen trip, start phase B, neutral , TOC-STL3,STN , zone 1 start , zone 1 trip , fault location= 8.30 km Ia= 96 A Ib=52A Ic= 7988 A In= 7994A Van=70 KV Vbn= 76 KV Vcn= 54 KV	Gen trip, Start phase C, distance strat, distance trip zone-1 , fault location= 35.25km Ia= 100A Ib= 61A Ic= 1.43 Kamp Van= 75.6 KV Vbn= 76.89 Kv Vcn= 50.43 KV	NA	LEFT	Line patrolling required
132 KV Bindal	Distance relay ABB REL 511	24-03-2023 20:41 hrs	24-03-2023 22:07 hrs	C.P. : DPS , DPT , Final trip R.P. : Gen trip, start phase B, neutral , TOC-STL3,STN , zone 1 start , zone 1 trip , fault location= 8.30 km Ia= 94 A Ib=41 A Ic= 8112 A In= 8129 A Van=71 KV Vbn= 78 KV Vcn= 54 KV	Gen trip, Start phase C, distance strat, distance trip zone-1 , fault location= 35.35km Ia= 99.6 A Ib= 50 A Ic= 1.47 Kamp Van= 75.9 KV Vbn= 76.96 Kv Vcn= 50.75 KV	NA	LEFT	Line againt trip 25-03-23 00:12hrs according to concern line staf line cross arm damage on tower no. 127 (approx 9 km from 220 KV Rishikesh)
132 KV Bindal	Distance relay ABB REL 511	25-03-2023 00:12 hrs	25-03-2023 15:44 hrs	C.P. : DPS , DPT , Final trip R.P. : Gen trip, start phase B, neutral , TOC-STL3,STN , zone	Gen trip, Start phase C, distance strat, distance trip zone-1 , fault location= 35.53km	NA	LHWT	Line againt trip 25-03-23 00:12hrs according to concern line staf line

Name of Feeder/TF	Type of Relay / Scheme	Date & Time of Tripping	Date & Time of closing	Flags observed	Other end flag	Tripping Analysis / Action taken report	Category Code	Action Taken
				1 start , zone 1 trip , fault location= 8.5 km Ia= 74.28 A Ib=22.37A Ic= 7937 A In= 8013A Van=72.15 KV Vbn= 79.14 KV Vcn= 55.30 KV		Ia= 76.69A Ib= 31A Ic= 1.46 Kamp Van= 75.6 KV Vbn= 76.89 Kv Vcn= 50.43 KV		cross arm damage on tower no. 127 (approx 9 km from 220 KV Rishikesh) / CROSS ARM CHANGED BY LINE STAFF
40MVA T/F-1 (132/33KV)	Schneider P143	16-04-2023 19:12 hrs	16-04-2023 20:25 hrs	C.P. : O/C & E/F prot. Optd R.P. : Active group 1, start phase ABCN, trip phase ABC , O/C start, E/F start, O/C Trip IA= 1.03Ka Ib=884 A Ic=1.13 Ka In=265 A	NA	33 KV Barrage feeder Y phase CT Blast feeder trip on O/C & E/F protection, burning C.T. & oil fall between 33 KV Barrage feeder C.B. Pole contact flashing observe at C.B. Contactet creating 33 KV Bus Fault	LEFT	33 KV Barrage feeder C.T replaced , C.B. & feeder protection checked , after work barrage feeder energise at 17-04-2023 05:35 hrs
40MVA T/F-2 (132/33KV)	Schneider P143	16-04-2023 19:12 hrs	16-04-2023 19:40 hrs	C.P. : O/C & E/F prot. Optd R.P. : Active group 1, start phase ABCN, trip phase ABC , O/C start, E/F start, O/C Trip IA= 1.13Ka Ib=895 A Ic=1.17 Ka In=268 A	NA		LEFT	
132 kv Srinagar	Micom	21-04-2023 00:11 hrs	21-04-2023 00:49 hrs	C.P. : DPS , DPT R.P. : active group 1, start phase A-N, trip phase ABC , distance startt , distance trip zone 1, fault location- 7.40 km Ia=7.89 Ka Ib= 0.01 Ka Ic= 0.01 Ka tripping relay 86	NA	Transient line fault	LEFT	Line patoling required informed concern line person
132 KV SRINAGAR	Siemens	09-05-2023 15:52 hrs	09-05-2023 16:13 hrs	C.P. : final trip. DPT,DPS R.P. : Power system fault ,fault event , pickup AG, Trip phase ABC, fault location =19 km IA= 4.31Ka , IB=0.01Ka IC=0.01 Ka	NA	Transient Line Fault		Line patrolling required inform concern persons
132 KV Laltap	ABB REL 511 Micom P143	17-05-2023 20:25 hrs	17-05-2023 20:57 hrs	O/C start R,Y,B phase , I>1 start , I> 1 trip, Ia=855 Amp , Ib= 935	NA	160 MVA (220/132 KV) transformer	Over Load	NA

Name of Feeder/TF	Type of Relay / Scheme	Date & Time of Tripping	Date& Time of closing	Flags observed	Other end flag	Tripping Analysis / Action taken report	Category Code	Action Taken
				Amp , Ic= 925 Amp, In=13 Amp Van=71.3Kv Vbn=71.7 Kv Vcn=71.8 Kv ,		trip at 220 KV S/S Jhajhara , due to this line trip on over load		
220KV Rishikesh-Dharashu I	Siemens Siprotec 7SA512	18-05-2023 07:07 hrs	18-05-2023 07:33 hrs	C.P. : main I , main II port. Operated R.P. : Dis. Pick up L3-E, dist. Loop L3-E, A/R lock , Definite trip on , dist trip 3 P on , zone-1 trip , fault location=11.90 km Ia=0.17 ka Ib=0.12 ka Ic=7.02 Ka tripping relay 86	main I ,Main II port. Operated	Transient Line Fault	B phase-Earth fault	Line patrolling required inform to concern line person( 220 KV S/S Chamba)
220 KV RKSH- Dharashu - II	Micom P444	23-05-2023 17:25 hrs	23-05-2023 17:37 hrs	C.P. : DPS ,DPT, Final trip R.P. : Active group 1, start phae B-N, dsistance trip zone-1 , fault location= 65.75km ia=29A Ib= 2.44 Ka Ic=30 A Van=126Kv Vbn=110 Kv Vcn=127 tripping relay 86	(try given from 220 KV RishikeshSide at 17:25 hrs)	Transient Line Fault	Phase-Earth	NA
220KV Rishikesh-Dharashu I	Siemens 7SA612	23-05-2023 17:33 hrs	23-05-2023 17:57 hrs	C.P. : Main1 .Main 2 prot. Operated R.P. : Dis pick up L2,L3, definite trip, zone -1 trip , IL1=0.23 Ka IL2=3.72Ka IL3=3.74 ka Distanse=11.00 km tripping relay 86	Dis pick up L2,L3, fault location=26.50 km	Transient Line Fault	Phase-Earth fault	Line patrolling required inform to concern line person
132 KV Bindal	ABB REL511	23-05-2023 21:15 hrs	23-05-2023 21:53 hrs	C.P. : DPS, DPT, final trip R.P. : Gen trip , start R pahse , Nuetral, TOC-STL1,STN , zone 2 start , zone 2 trip , IL1=2783A IL2=260A IL3=270 A Van=68.3Kv Vbn=81KV Vcn=80.70 KV	start phase A, zone-1 trip , fault location= 8.69 km	Transient Line Fault	Phase-Earth fault	Line patrolling required inform to concern line person

Name of Feeder/TF	Type of Relay / Scheme	Date & Time of Tripping	Date & Time of closing	Flags observed	Other end flag	Tripping Analysis / Action taken report	Category Code	Action Taken
132 KV Srinagar	Siemens	23-05-2023 21:41 hrs	24-05-2023 01:43 hrs	C.P. DPS ,DPT, R.P. : Gen trip, start phase A-N, trip phase ABC ,Distanse trip zone-1 , fault location= 7.40 km Ia=6.96 Ka Ib=0.01Ka Ic=0.01Ka , tripping relay 86	Line half section charged from Rishikesh end ( other section under S/D for tower Work)	Transient Line Fault	Phase-Earth fault	Line patrolling required inform to concern line person
132 KV Srinagar	Siemens	25-05-2023 17:06hrs	25-05-2023 17:27 hrs	C.P. : DPS,DPT,Final trip R.P. : Active group 1, start phase A-N, trip phase ABC, distance trip zone-1 , Ia=7.45Ka Ib=0.01 Ka Ic=0.1ka Fault location= 7.4 km tripping relay 86	NA	NA	phase-Earth fault	Line patrolling required
C.B. 73 JAWALAPUR (22.97 KM)	ABB REL511	16-06-2023 02:30 hrs	16-06-2023 02:46 hrs	C.P:- Dis.prot.start,Dist. Prot. Trip. R.P:- Gen trip , start R phase, start B phase, zone 1 trip, TOC - STL 1, TOC- STL 3, active group 1 , IA= 8577A , IB= 189.8A , IC =8713 A, In=27A, U1= 39.60 KV , U2= 76.04 KV , U3= 43.69 KV, U4=0.00Kv	Active Group 1 Start phase R, B, Zone 1 Trip Fault location 17.90 KM, IA=3.88 Ka Ib=0.18 Ka, Ic=3.75 Ka	transient line fault	LPPT	Line Petroling Required inform concern line person
40MVA T/E-1 132/33 KV 33KV .	Micom P143	24-06-2023 12:02 hrs	24-06-2023 12:23 hrs	L.V. O/C & E/F Protection operated , Ia=72 A, Ib= 1.09 Ka ,Ic= 137 A , Ie= 1.14 Ka	NA	33 KV GIS feeder Y phase C.T. Clamp broken before feeder C.T. Create 33 KV Bus Fault	LEFT	NA
.40MVA T/F-2 132/33	Micom P143	24-06-2023 12:02 hrs	24-06-2023 12:23 hrs	L.V. O/C & E/F Protection operated , Ia=79 A, Ib= 1.04 Ka ,Ic= 134 A , Ie= 1.19 Ka	NA		LEFT	NA
220 kv r ksh-	Siemens Siprotec 7SA612	25-06-2023 16:50 hrs		C.P. : Main 1 , main 2 prot. Operated R.P. : Gen trip , Dis pick up L31,	Dharashu P/H (C.B. 88) Main 1,main 2 prot. Operated , zone-1 trip ,	220 KV Rishikesh - Dharashu Line 'R' phase	LPPT	line under shutdown fault attending

Name of Feeder/TF	Type of Relay / Scheme	Date & Time of Tripping	Date& Time of closing	Flags observed	Other end flag	Tripping Analysis / Action taken report	Category Code	Action Taken
				O/C pick up L1, L3, A/R block , definite trip on , zone-1 trip , IL1= 8.54 Kamp II2=0.28 Kamp IL3=8.29 Kamp , fault location= 13.10 km tripping relay 86 , 863	fault location= 59.70 km , IL1= 1.76 Ka IL2= 0.30 Ka IL3= 2.05 Ka	conductor wire was broken & Touch 'B' Phase Conductor		work on progress
132kv Srinagar	Siemens	17-07-23 13:18 hrs	17-07-23 13:31 hrs	start phase C-N, trip phase ABC, distanse trip zone-1 , Ia=0.01 Ka Ib=0.01 Ka Ic= 6.73 Ka fault location= 3.10 Km tripping relay 86	NA	Transient Line Fault	LEFT	line patrolling required inform concern line person.
132 KV Lal Tapeer	ABB REL 511 Micom P143	19-07-2023 14:25 hrs	19-07-2023 14:58 hrs	Gen trip , start phase B, O/C start , O/C I>1 trip , Ia= 301 A Ib= 485 A Ic= 388 A In= 80 A	NA	Line trip on over load	CMST	NA
132 KV Bindal	ABB REL 511	19-07-2023 14:27 hrs	19-07-2023 14:53 hrs	Gen Trip , O/C start , O/C Trip , Ia= 453 A , Ib= 484 A Ic= 473 A In= 4 A	NA	Line trip on over load	CMST	NA
220 KV Chamba	Micom P444	30-07-2023 18:55 hra	line under Shut down	C.P. : DPS,DPT,Final trip R.P. : Active group -1, start phase C-N, trip phase ABC, distanse trip zone-1, Ia=341A Ib=408A Ic=14.13Kamp Van=109Kv Vbn=117Kv Vcn=60Kv Fault Location= 5.62 Km tripping relay 86	O/E : 220 KV S/S Chamba CB84 Active group-1, start phase C-N, trip phase ABC , distanse trip zone-2 , Ia=339A Ib=408A Ic=1.45Kamp Van=124Kv Vbn=125Kv Vcn=41Kv fault location= 39Km tripping relay 86	220 KV Rishikesh-Chamba line "B" phase conductor wire broken from tower clamp fitting(tower number 9 approx 3.00 km from 220 KV Rishikesh )	LHWT	NA
220 KV IIP	Siemens 7SA612 7SA52	08-09-2023 18:01 hrs	09-09-2023 04:36 hrs	C.P. : main 1, main 2 prot. Operated R.P. : Dis pick up L1-E , def. Trip on , dist. Trip 3 P on ,zone-1 trip , IL1= 13.15 ka IL2=0.52 Ka IL3= 0.20 Ka fault location= 2.30km three phase trip relay 863 A, 863 B	NA	Rishikesh - IIP line R phase conductor suspension disc string was broken approx 2.5 km from 220 KV S/S Rishikesh	LEFT	Fault remove by concern line person

Name of Feeder/TF	Type of Relay / Scheme	Date & Time of Tripping	Date & Time of closing	Flags observed	Other end flag	Tripping Analysis / Action taken report	Category Code	Action Taken
220 KV IIP	Siemens siprotec 7SA612 7SA52	05-09-2023 13:33 hrs	05-09-2023 15:38 hrs	C.P. : main 1 , main 2 prot. Operated R.P. : O/C pick up L3 on, I>> on, dis. Pick up L2,L3 on, def. Trip on. Dis. Trip 3 P on , zone-1 trip , IL1= 0.01 Ka IL2= 7.08 Ka IL3=6.19Ka fault location = 16.90 three phase trip relay 863A, 863 B	fault loop C-G, Ia= 257A Ib=246 A , Ic= 801 A Ie=969A , Van= 128Kv Vbn=122Kv Vcn= 113Kv fault location= 28.20 Km	NA	LEFT	NA
220 KV SIDCUL	Micom P444	15-09-2023 02:06 hrs	15-09-2023 03:22 hrs	C.P. : DPS ,DPT R.P. :Active group-1 , start phase A-N , distanse trip zone-1, fault location=7.76 km Ia=8.11 Kamp Ib=710 A Ic=587 A Van=46.84KV Vbn=125.5KV Vcn=124KV tripping relay 86	Dsitance trip zone-1 , fault location= 11.94 Km Ia=4.73 Ka Ib=612 A Ic=606A	Transient line fault bed weather rain & lightning	LEFT	line patrolling required inform to concern line person's
220 KV IIP	Siemens Siprotec 7SA612 7SA52	15-09-2023 01:41 hrs	15-09-2023 02:30 hrs	C.P. : main 1, main 2 prot. Operated R.P. : Dis. Trip 3P on, definite trip on , IL1=0.13Ka IL2=5.66Ka IL3=0.05Ka fault location= 19.90 km tripping relay 863A,863B	start phase B-N, distanse trip zone-1 , fault location=8.46 KM Ia=128 A Ib=4.16 Ka Ic=41 A Van=136KV Vbn=31.6KV Vcn=141.7KV	Transient line fault bed weather rain & lightning	LEFT	line patrolling required inform to concern line person's
132 KV bhopatwla-chilla	Distanse Protection Micom P444	25-09-2023 11:30 hrs	25-09-2023 18:26 hrs	C.P. : DPS, DPT R.P. : Active group-1, start phase B-N ,dsitanse trip zone-1 , fault duration=76.8 m.sec , fault location=10.28km Ia= 709 A Ib= 5.11 Kamp Ic= 931 A Van=77.2KV Vbn=34.3Kv Vcn= 73.7Kv tripping relay 86	132KV S/S Bhopatwala: Rishikesh-chilla line trip zone-1 ,Yphase fault, fault location=6.7 km Chila Power house: no tripping at line, all machine triped	Some obstreet comse in line Y phase conductor	LEFT	line patrolling by concern line persons

Name of Feeder/TF	Type of Relay / Scheme	Date & Time of Tripping	Date & Time of closing	Flags observed	Other end flag	Tripping Analysis / Action taken report	Category Code	Action Taken
220 KV Jwalapur	Distance Protection ABB REL-511	25-09-2023 11:30 hrs	25-09-2023 11:52 hrs	C.P. : DPS,DPT R.P. : Gen trip , start Y phase, B phase ,TOC-STL,STL2,STN , zone 3 trip Ia=552 A Ib=3009A Ic=2544 A In=1289A U1=73.6KV U2=60.46 KV U3=60.8KV	no tripping at 132 KV S/S Jwalapur , at jwalapur S/S Rishikesh & chila feeder on same bus	Chila power house all machines trip at 11:30 hrs	NA	NA
220 KV IIP Harawala	Siemens 7SA612 7SA52	25-09-2023 13:58hrs	25-09-2023 15:32 hrs	C.P. : Main-1 , Main-2 prot operated R.P. : Gen trip, Dis. Pick up L2-L3, def trip, dist trip 3P , zone-1 trip IL1=0.17Ka IL2=11.38Ka IL3=11.11Ka Distance= 4.2 km	Y-B phase Pick up , zone-2 trip , IA=185.1A, IB=2.90KA, Ic= 3.07 Ka fault location =25.28 Km	NA	LEFT	line patrolling by concern line persons
Name of	Type of Relay/CB No	Date and Time of Tripping	Date and Time of Closing	Flags Observed	Other Element Flags	Analysis of Tripping	Category Code	Action Taken
76 Rishikesh-Bhopatwala-Chila P/H	Micom	09-10-2023 13:46 hrs	09-10-2023 15:26 hrs	C.P. : DPS ,DPT R.P. : active group-1 , start phase A-N , distanse trip zone-1 , fault location = 1.518 km Ia= 8.22 Ka Ib=198 A Ic= 122 A Van=39.38 Kv Vbn=88.20Kv Vcn=80.43Kv tripping relay 86	<u>132 KV S/S Bhopatwala</u> : no tripping 132 KV grid supply fail ( radial feeding , Bhopatwala-Jwalapur line opened ) <u>Chila power House</u> : no tripping on line , running 03 machine's trip & supply fail at power house .	accoding to concern person's loud sound was observed near line approx. 2.0 km from 220 KV Rishikesh S/S	LEFT (Rphase-Earth fault )	Line patrolling by concern line persons
81 SIDCUL Haridwar	Micom P444	07-11-2023 13:38 hrs	07-11-2023 17:52 hrs	C.P. : DPS,DPT, A/R Lock , Final trip R.P. : Active group-1 , start phase B-N , distanse trip zone-1 , fault location=517 meter Ia= 101 Amp Ib=12.40 Kamp Ic=508A Van=128.3 Kv Vbn=15.32Kv Vcn=128.3Kv tripping relay 186 ,86	<u>O/E : 220 KV S/S Sidcul</u> : Active group-1, start phase B-N, distanse trip zone-2 , Ia= 463A Ib=4.42 Ka Ic=823 A fault location= 15.94 Km	According to concern line persons during house construction work bamboo stick from labour hand comes in line range	LEFT Phase-EARTH fault	Line patrolling by concern line person

Name of Feeder/TF	Type of Relay / Scheme	Date & Time of Tripping	Date & Time of closing	Flags observed	Other end flag	Tripping Analysis / Action taken report	Category Code	Action Taken
72 Bindal	ABB REL511	07-02-2024 14:59 hrs	07-02-2024 15:34 hrs	C.P. : DPS ,DPT R.P. : Gen trip , start R,Y phase , TOC-STL1, STL2, STN , zone-1 start , zone-1 trip, fault loop L1-L2, fault location=0.300 km Van=38.22 KV Ia= 11966 Amp Vbn=34.33 KV Ib= 13459 Amp Vcn= 80.08 KV Ic= 254 Amp In= 2033 Amp	<u>132 KV S/S</u> <u>Bindal :</u> zone-2 trip, fault location=46.63km Ia=2.13 Ka Van=57.66 KV Ib= 2.13 Ka Vbn=57.22 KV Ic = 10A Vcn= 76.85 KV	according to concern person Loud blast sound observe outside 220 KV S/S Rishikesh switch yard ( Eagle's & Birds observe at spot)	Phase-Phase fault R-Y phase	after confirmation line try given line hold OK
73 Rishikesh-jwalapur line 22.97 km	ABB REL511	23-03-2024 13:37 hrs	23-03-2024 13:54 hrs	C.P. : DPS, DPT R.P. : Gen trip , start phase B, start neutral , zone-1 start , zone-1 trip , TOC-STL3 , STN Fault Loop L3-N , Location= 10.40 km Van= 76.26 KV Vbn=76.36 KV Vcn=44.67 KV Ia=367 A Ib=203 A Ic=5020 A In=4490 A	zone-1 operated , B phase pick up ,IL1=0.31 Ka IL2=0.18 Ka IL3=5.59 Ka fault location = 9.20 km	according to concern line person during building construction work, labour work with iron rod comes in line range	LEFT	NA
C.B. 72 Bindal (44.70 Km)	ABB REL 511 & Schneider P143	15-04-2024 21:12 hrs	15-04-2024 21:33 hrs	C.P. : DPS , DPT, Final Trip R.P. : Gen trip , start R phase , Neutral , zone-1, zone-2 start , zone-1 trip , Fault loop L1-N, fault location = 8.60 km Van= 53.48 KV Vbn=70.22 KV Vcn=76.24 Kv I1= 7749 A I2=85 A I3=52 A I4=7764 A	Active group-1 , start phase A-N , distanse trip zone-1 , fault location= 35.37 km Ia=1.41 Ka Ib=84 A Ic= 55 A Van=49.4 Kv Vbn=76 Kv Vcn=76.4 Kv	According to concern line person during line patrolling Line 'R' phase disc found puncture at tower number 27	NA	Line shutdown taken for removing fault 16-04-2024 09:30 hrs
C.B. 72 Bindal (44.70 Km)	ABB REL 511 & Schneider P143	16-04-2024 03:20 hrs	16-04-2024 03:41 hrs	C.P. : DPS , DPT, Final Trip R.P. : Gen trip , start R phase , Neutral , zone-1, zone-2 start , zone-1 trip , Fault loop L3-N, fault location = 8.60 km Van= 71.35 KV Vbn=78.48 KV	Active group-1 , start phase A-N , distanse trip zone-1 , fault location= 35.11 km Ia=52A Ib=42 A Ic= 1.51Ka Van=77.4 Kv Vbn=78.2 Kv Vcn=50.22 Kv	According to concern line person during line patrolling Line 'B' phase disc found puncture at tower number 27	NA	NA



Name of Feeder/TF	Type of Relay / Scheme	Date & Time of Tripping	Date & Time of closing	Flags observed	Other end flag	Tripping Analysis / Action taken report	Category Code	Action Taken
				Vcn=53.53 Kv I1= 51 A I2=35 A I3=7933 A I4=7972 A				
C.B. 73 JAWALAPUR	ABB REL511	19-04-24 18:23 hrs	19-04-2024 21:59 hrs	C.P:- Dis.prot.start,Dist. Prot. Trip. R.P:- Gen trip , start R phase,Y phase , zone-1 start, zone-1 trip, fault loop L1-L2 , Fault location = 1.30 km I1=11445A IL2=11414A IL3=50A Van=44.95 Kv Vbn=35.91 Kv Vcn=79.78 Kv	Dist. Pick up L1- L2, O/C & E/F prot. Trip , IL1= 4.70 Ka IL2=4.68 Ka IL3= 0.01 Ka (Line charge at 21:59 hrs from 220 KV S/S Rishikesh end 132 KV Jwalapur S/S Line C.B. Not close )	Due to heavy storm one tree is broken it's braches comes in line R & Y phase conductor range	PHASE TO PHASE	fault remove by concern line persons
IIP(31.00 Km) Dehradun  83	Siemens 7SA52	22-04-2024 10:24 hrs	22-04-2024 11:59 hrs	C.P. : main-1 , main-2 prot. Optd, A/R Block R.P. : O/C pick up L3 on,I>on, I>>on, definite trip on, dist. Trip 3P on, zone-2 trip , fault loop L3-E, fault location =26.70 km IL1=0.01 ka IL2=0.01ka IL3=4.00Ka three phase trip relay 863A,863B	Dist. Trip zone-1 , fault location=2.17 km Ia= 10 A Ib=182 A Ic= 4.00 ka tripping relay 86- 1, 86-2	According to concern line persons during construction work bellow line labour comes line "B" phase conductor range	NA	After patrolling line try given line hold
Rksh-Dharashu-II 79.40 Km  87	Micom P442	18-05-2024 17:51 hrs	18-05-2024 18:16 hrs	C.P. : DPS,DPT, Final trip R.P. : Active group-1, start phase A-N , distanse trip zone- 1 , fault location=50.71 km Ia= 2.67 Ka Ib=477 A Ic= 124 A Van= 95 KV Vbn=123 KV Vcn=123.4KV tripping relay 86	Dis. pick Up L1- E, dist. Trip zone- 1, fault location=30.30 km	NA	NA	NA
72 Rishikesh- Bindal feeder	ABB REL-511 Schneider P143	27-05-24 11:06 hrs	27-05-2024 11:21 hrs	C.P. : DPS ,DPT, Final trip R.P. : Gen trip , start R phase, start B phase, Neutral , TOC- STL1,STL3,STN , zone-2 start, zone- 2 trip ,	O/E : R phase pick up, zone-1 trip ,	Transient Line fault	R phase- Earth fault	Line patrolling by concern line persons

Name of Feeder/TF	Type of Relay / Scheme	Date & Time of Tripping	Date& Time of closing	Flags observed	Other end flage	Tripping Analysis / Action taken report	Category Code	Action Taken
				fault location = 44.80 km, Van=57.59 KV Vbn=69.83 KV Vcn= 70.49 KV IL1=2954 A IL2= 353 A IL3=641 A IL4= 2318 A				
72 Rishikesh-Bindal	ABB REL 511 Schneider P143	30-05- 2024 12:27 hrs	30-05- 2024 13:09 hrs	C.P. : DPS ,DPT , Final trip R.P. : Gen trip , start R,Y phase , Neutral , TOC- STL1 , STL2 , STN , Zone-1, zone-2 start, zone-1 trip , fault location =9.60 km Van=65.84 Kv Vbn= 24.92 Kv Vcn=58.14 Kv Ia= 481 A Ib= 7639 A Ic=375 A In=7292 A	no tripping at 132 KV S/S Bindal , 132 KV Grid supply fail at 132 KV S/S Bindal ( radial feeding from 220 KV S/S Rishikesh )	NA	NA	NA

## 5.0. Observations and Recommendations

### 5.1. Reporting of all the Tripping with DR/EL

- a. For the interstate lines, as per IEGC clause 37.2(c) and clause 15.3 of CEA grid standard, all the DR/EL reports shall be uploaded on Web Based Tripping Monitoring System “http://103.7.128.184/Account/Login.aspx” within 24 hours of the events. These are being submitted by sub-station to NRLDC portal, however the record of the same is not kept at substation level.

Status of submission of FIR/DR/EL/Tripping Report on NR Tripping Portal																	
Time Period: 1st January 2024 - 31st January 2024																	
S.No.	Utility	Total No. of tripping	First Information Report (Not Received)		Disturbance Recorder (Not Received)		Disturbance Recorder (NA) as informed by utility		Event Logger (Not Received)		Event Logger (NA) as informed by utility		Tripping Report (Not Received)		Tripping Report (NA) as informed by utility	Tripping Report (Not Received)	Remark
			Value	%	Value	%	Value	%	Value	%	Value	%					
36	SLDC-PS	29	2	7	13	6	57	13	5	54	16	0	55				
37	SLDC-RS	130	12	9	23	11	19	23	9	19	39	0	30	DR, EL & Tripping report need to be submitted			
38	SLDC-UK	6	0	0	0	4	0	0	4	0	1	3	33				
39	SLDC-UP	80	10	13	11	9	15	12	10	17	11	1	14				
40	STERLITE	1	0	0	0	0	0	0	0	0	0	1	0	Details received			
41	TANAKPUR-RH	4	1	25	1	0	25	1	0	25	1	0	25	DR, EL & Tripping report need to be submitted			
42	UMCHAHAR-NT	1	0	0	0	0	0	0	1	0	0	0	0	Details received			
Total in NR Region		520	147	28	169	69	37	171	70	38	185	17	37				

*As per the IEGC provision under clause 37.2(c), detailed tripping report along with DR & EL has to be furnished within 24 hrs of the occurrence of the event*

Ref: NRPC 216 OCC Agenda (Annexure B.VIII)

- b. For the tripping of intra-state lines, the brief tripping reports are submitted to Divisional office. The DR/EL reports are downloaded by respective officials and forwarded, as per need basis. The record of these DR/EL is not kept at sub-stations
- c. It is recommended that each sub-station to have a central repository of such tripping reports, along with DR/EL reports and analysis. A dedicated PC can be kept for this.

### 5.2. Development of centralized database of relay settings

- a. In 48th TCC & 70th NRPC Meeting (held on 17-18 Nov 2023), NRPC Committee has approved for development of a portal through PSDF for Centralized database containing details of relay settings for grid elements connected to 220KV and above. Portal shall have other features including protection setting calculation tool. A nodal officer shall be providing this data at central portal.
- b. The relay settings for below 220KV are to be calculated by SLDC and/or central level. The relays are tested by sub-station officials as per need basis, but the record of recommended

settings/ calculation is not kept at sub-station level. This makes it difficult to validate the settings and test results, in case of relay testing.

- c. It is recommended that latest recommended relay settings, as decided by RLDC for 220KV & above and by SLDC below 220KV along with setting calculations & parameters used for all the relays be kept at sub-station level. This will help in proper fault analysis and ascertaining relay healthiness.

### **5.3. *Review of test results of relay and equipment***

- a. Testing of most of the equipment is carried out, as per availability of shut-down and testing equipment. After testing, the test records are summarily recorded in testing register, with remarks as “tested. OK”.
- b. For the numeric relay testing, the testing is carried out by supplier at the time of installation and subsequently as per need basis, including at the time of change in settings.
- c. A draft O&M manual is available at PTCUL web-site, which includes various tests and their frequency, along with results. This manual is based on CERC/SERC regulations of 2004-2008. It is recommended that this manual may be updated and implemented and record of test values may be kept for future reference.

### **5.4. *Availability of Testing Kits***

- a. The availability of testing equipment is limited at each substation. For comprehensive testing of equipment, as per above para, sufficient testing kits at each substation/Sub-division/ Division level are required.
- b. Based on the O&M manual, it is recommended that sufficient quantity of testing instruments be made available at sites for regular testing of equipment. A suggested list of Testing Equipment is attached at Annexure – 1.

### **5.5. *Up-dation of PTCUL Protection Philosophy***

The protection philosophy adopted by Utility, in general, is in alignment with protection philosophy adopted by NRPC. As the NRPC has recently updated the protection philosophy, PTCUL in consultation with SLDC may update protection philosophy for network not covered by NRPC, if needed, and implement the same.

### **5.6. *Simulation based study of protection system***

As per IEGC, protection code, during audit the relay settings to be adopted shall be validated with simulation based or EMTP studies and details shall be enclosed in report. The current scope of audit was excluding these studies, therefore, Simulation based or EMTP Studies should be carried out by the Utility, as per the requirement of Grid Code.

### **5.7. *Capacity Building of protection team***

During the discussions with officials at site, it was observed that the teams responsible for the protection system and SAS, needs to be updated on current trends on protection system, communication schemes and Sub-station automation. Utility may undertake capacity building exercise for the officials involved in these activities.

### **5.8. *Updated Fault Level/ Short Circuit Level and Network information***

The fault level/ short circuit level for each substation is being calculated at central level. Such studies are carried out, as and when new elements are added in the network. This has impact on relay settings parameters and equipment ratings. It is recommended that the updated network information and short circuit level be maintained at central level for revising the setting as per requirement.

### **5.9. *General Protection related observations***

The study of Fire protection system/ Nitrogen Injection Fire Protection System, Lightning Protection system, Earthing Mat/ Earthing Protection are not covered under protection audit. Utility may get a comprehensive technical and safety audit carried out internally or thru third party and corrective action for any discrepancy be taken up accordingly.

### **5.10. *O&M Manual***

The Utility has a draft O&M manual uploaded on its website, which is being referred by working level officials as a guideline for regular O&M and testing functions. This manual needs to be updated to incorporate recent developments and approved for regular use in all sub-stations to bring uniformity in O&M and testing practices across the utility.

## 6.0. Station Specific Observation and Recommendations

### 6.1. Protection related observations and recommendations

- a. For 220 KV, Bus Bar Protection is available but not in use due to being obsolete and defective. Currently, the Zone 4 settings are kept at 0.25 secs in Reverse Zone. The process for procurement has been initiated. The process needs to be expedited.
- b. For both 220KV and 132KV switchyards, double Main and Transfer Bus scheme is provided. Single breaker acts as Bus Coupler (BC) and Transfer Bus coupler (TBC). Both the Main Buses are hard coupled using two isolators (A and B) of Main Bus, to keep TBC breaker free, although, buses can also be coupled through the TBC breakers, for this purpose, O/C +E/F relay is provided for protection. This philosophy needs to be reviewed, at the time of commissioning of bus-bar protection.
- c. For 220KV Dharashu line 2 II, Micom P442 and for 220KV SIDCUL line, Micom P444 is provided as distance protection. In addition, relay Siemens 7SJ62 is provided as back up O/C + E/F Protection for both feeders. The back-up protection needs to be replaced with distance protection, in line with protection philosophy.
- d. 220KV side of 400/220KV Transformer are not connected through Transfer Bus. Possibility of connecting them thru Transfer bus be explored for ease of testing and maintenance of 220KV circuit breakers.
- e. 132 KV BINDAL line BCU is not working. This needs to be rectified.
- f. The SAS is working partially, some analog and digital signal are not appearing. SAS System needs to be updated/upgraded.
- g. The SAS GUI takes the time from window operating system. As the system is not connected to internet, the window time is not synchronised, therefor the time synchronization of windows OS needs to be done at regular interval, otherwise clock of SAS GUI shows different time. It is suggested to take necessary remedial measures for the same.

### 6.2. Equipment related observations and recommendations

- a. PTCUL has submitted a list of switchyard equipments to be replaced under PSDF funding, as per Annexure - 2. In view of the need of modern sub-stations, where automation of sub-station is of paramount importance, these replacements are required. Based on the specifications and healthiness of existing equipments, the list may be reviewed by PTCUL. In addition, it is recommended that sufficient quantity of maintenance equipments be made available at sites. A suggested list of **Maintenance Equipment is attached at Annexure – 3.**

### ***6.3. Auxiliary Equipment related observations and recommendations***

- a. The auxiliary supply is received from two sources i.e. 132KV IDPL and 33KV S/S Rishikesh and is quite reliable. No standby DG set is provided. Necessary action may be taken for emergency auxiliary supply.
- b. The whole system is designed for single DC source; therefore, 110V DC supply to different Relays /Buses/SAS is distributed among both DCDBS on single source basis. Possibility of dual source DC for protection be examined by PTCUL.

## Annexure – 1: Suggested List of Testing Instruments

CBIP suggests the following list of testing instruments based on the approved O&M manual

Sl. No.	Testing Instruments
1	DCRM for Circuit Breaker
2	DC Earth Fault Locator
3	SF6 Gas Density Monitor
4	SF6 Gas Leakage detector/ Imaging Camera
5	CB Analyser
6	Earth Resistance Tester
7	Portable Digital Selective Level Meter cum Level Generator
8	Selective Level Generator
9	LA Leakage Current Analyser
10	Digital Multi-meter
11	Tong Tester
12	Tan Delta Test Kit
13	Digital Leakage Clamp Meter
14	Phase Sequence Indicator
15	Megger (5 KV)
16	Digital Capacitance Meter
17	CT Polarity Tester
18	PT Test Set



## Annexure – 2: Suggested List of Substation Equipments

The suggested list of Substation Equipments keeping in mind the necessity for the modernization and upgradation of substations.

Sl. No.	Equipment	Unit	Quantity
A	<b>220KV Equipment</b>		
1	245KV Current Transformer (5 Core), Class 0.2 (1 ph) 800/400/1	Nos	6
2	245KV Current Transformer (5 Core), Class 0.2 (1ph) 1000/500/1	Nos	3
3	245KV CVT 1 Ph	Nos	14
4	216KV Surge Arrestor 1Ph (Polymer)	Nos	15
B	<b>132KV Equipment</b>		
1	145KV Circuit Breaker 3PH	Nos	2
2	145KV. 1250A, (3 Phase) HDB Isolator without E/s (Mettalic & Insulator)	Nos	6
3	145KV. 1250A, (3 Phase) HDB Isolator with one E/s (Mettalic & Insulator)	Nos	5
4	145KV Current Transformer 1Ph	Nos	4
5	145KV CVT	Nos	3
6	132KV Surge Arrestor 1Ph (polymer)	Nos	6
C	<b>33KV Equipment</b>		
1	33KV Circuit Breaker	Nos	2
2	33KV Isolator 3Ph	Nos	4
3	33KV Current Transformer 1 Ph	Nos	15
4	33KV PT	Nos	2
5	33KV Surge Arrestor 1 Ph (polymer)		18

### Annexure – 3: Suggested List of Maintenance Equipments

Sl. No.	Equipment
1	Oil Filter Machine
2	SF6 Gas Handling Plant
3	SF6 Gas Density Monitor
4	Thermo-Vision Camera Lines and Sub-Station
5	Binocular Vision Camera
6	SF6 Gas Leakage Imaging Camera
7	LA Leakage Current Analyser
8	Online DGA
9	Oil BDV Kit
10	Hydraulic Crimping Tool for different Types of ACSR Conductor
11	Hydraulic Conductor Cutter
12	Fork Lift 5 Ton Capacity
13	Digital Leakage Clamp Meter

A mobile van with test kits can be kept for optimizing the resources at various substations

## Annexure – 4: Protection Code (IEGC 2023 Chapter 4)

- **General**

1. This chapter covers the protection protocol, protection settings and protection audit plan of electrical systems.
2. There shall be a uniform protection protocol for the users of the grid:
  - a) for proper co-ordination of protection system in order to protect the equipment/system from abnormal operating conditions, isolate the faulty equipment and avoid unintended operation of protection system;
  - b) to have a repository of protection system, settings and events at regional level;
  - c) specifying timelines for submission of data;
  - d) to ensure healthiness of recording equipment including triggering criteria and time synchronization; and
  - e) to provide for periodic audit of protection system.

- **Protection protocol**

1. All users connected to the integrated grid shall provide and maintain effective protection system having reliability, selectivity, speed and sensitivity to isolate faulty section and protect element(s) as per the CEA Technical Standards for Construction, the CEA Technical Standards for Connectivity, the CEA (Grid Standards) Regulations, 2010, the CEA Technical Standards for Communication and any other applicable CEA Standards specified from time to time.
2. Back-up protection system shall be provided to protect an element in the event of failure of the primary protection system.
3. RPC shall develop the protection protocol and revise the same, after review from time to time, in consultation with the stakeholders in the concerned region, and in doing so shall be guided by the principle that minimum electrical protection functions for equipment connected with the grid shall be provided as per the CEA Technical Standards for Construction, the CEA Technical Standards for Connectivity, the CEA Technical Standards for Communication, the CEA (Grid Standards) Regulations, 2010, the CEA (Measures relating to Safety and Electric Supply) Regulations, 2010, and any other CEA standards specified from time to time.

4. The protection protocol in a particular system may vary depending upon operational experience. Changes in protection protocol, as and when required, shall be carried out after deliberation and approval of the concerned RPC.
5. Violation of the protection protocol of the region shall be brought to the notice of concerned RPC by the concerned RLDC or SLDC, as the case may be.

- **Protection settings**

1. RPCs shall undertake review of the protection settings, assess the requirement of revisions in protection settings and revise protection settings in consultation with the stakeholders of the respective region, from time to time and at least once in a year. The necessary studies in this regard shall be carried out by the respective RPCs. The data including base case (peak and off-peak cases) files for carrying out studies shall be provided by RLDC and CTU to the RPCs:
2. All users connected to the grid shall:
  - a) furnish the protection settings implemented for each element to respective RPC in a format as prescribed by the concerned RPC;
  - b) obtain approval of the concerned RPC for,
    - i. any revision in settings, and,
    - ii. implementation of new protection system;
  - c) intimate to the concerned RPC about the changes implemented in protection system or protection settings within a fortnight of such changes;
  - d) ensure correct and appropriate settings of protection as specified by the concerned RPC.
  - e) ensure proper coordinated protection settings.
3. RPCs shall:
  - a) maintain a centralized database and update the same on periodic basis in respect of their respective region containing details of relay settings for grid elements connected to 220 KV and above (132 KV and above in NER). RLDCs shall also maintain such database.
  - b) carry out detailed system studies, once a year, for protection settings and advise modifications / changes, if any, to the CTU and to all users and STUs of their respective regions. The data required to carry out such studies shall be provided by RLDCs and CTU.

- c) provide the database access to CTU and NLDC and to all users, RLDC, SLDCs, and STUs of the respective regions. The database shall have different access rights for different users.
4. The changes in the network and protection settings of grid elements connected to 220KV and above (132 KV and above in NER) shall be informed to RPCs by CTU and STUs, as the case may be.

The elements of network below 66KV and radial in nature which do not impact the National Grid may be excluded as finalized by the respective RPC.

- **Protection audit plan**

1. All users shall conduct internal audit of their protection systems annually, and any shortcomings identified shall be rectified and informed to their respective RPC. The audit report along with action plan for rectification of deficiencies detected, if any, shall be shared with respective RPC for users connected at 220 KV and above (132 KV and above in NER).
2. All users shall also conduct third party protection audit of each substation at 220 KV and above (132 KV and above in NER) once in five years or earlier as advised by the respective RPC.
3. After analysis of any event, each RPC shall identify a list of substations / and generating stations where third-party protection audit is required to be carried out and accordingly advise the respective users to complete third party audit within three months.
4. The third-party protection audit report shall contain information sought in the format enclosed as Annexure–1. The protection audit reports, along with action plan for rectification of deficiencies detected, if any, shall be submitted to the respective RPC and RLDC or SLDC, as the case may be, within a month of submission of third-party audit report. The necessary compliance to such protection audit report shall be followed up regularly in the respective RPC.
5. Annual audit plan for the next financial year shall be submitted by the users to their respective RPC by 31<sup>st</sup> October. The users shall adhere to the annual audit plan and report compliance of the same to their respective RPC.
6. Users shall submit the following protection performance indices of previous month to their respective RPC and RLDC on monthly basis for 220 KV and above (132 KV and above in NER) system, which shall be reviewed by the RPC:
  - a. The Dependability Index defined as

$$D = \frac{N_c}{N_c + N_f}$$

where,

$N_c$  is the number of correct operations at internal power system faults and

$N_f$  is the number of failures to operate at internal power system faults.

- b. The Security Index defined as

$$S = \frac{N_c}{N_c + N_u}$$

where,

$N_c$  is the number of correct operations at internal power system faults

$N_u$  is the number of unwanted operations.

- c. The Reliability Index defined as

$$R = \frac{N_c}{N_c + N_i}$$

where,

$N_c$  is the number of correct operations at internal power system faults

$N_i$  is the number of incorrect operations and is the sum of  $N_f$  and  $N_u$

7. Each user shall also submit the reasons for performance indices less than unity of individual element wise protection system to the respective RPC and action plan for corrective measures. The action plan will be followed up regularly in the respective RPC.
8. In case any user fails to comply with the protection protocol specified by the RPC or fails to undertake remedial action identified by the RPC within the specified timelines, the concerned RPC may approach the Commission with all relevant details for suitable directions.

- **System Protection Scheme (SPS)**

1. SPS for identified system shall have redundancies in measurement of input signals and communication paths involved up to the last mile to ensure security and dependability.
2. For the operational SPS, RLDC or NLDC, as the case may be, in consultation with the concerned RPC(s) shall perform regular load flow and dynamic studies and mock testing for reviewing SPS parameters & functions, at least once in a year.
3. RLDC or NLDC shall share the report of such studies and mock testing including any shortcomings to respective RPC(s). The data for such studies shall be provided by CTU to the concerned RPC, RLDC and NLDC.
4. The users and SLDCs shall report about the operation of SPS immediately and detailed report shall be submitted within three days of operation to the concerned RPC and RLDC in the format specified by the respective RPCs.
5. The performance of SPS shall be assessed as per the protection performance indices specified in these Regulations. In case, the SPS fails to operate, the concerned User shall take corrective actions and submit a detailed report on the corrective actions taken to the concerned RPC within a fortnight.

- **Recording instruments**

1. All users shall keep the recording instruments (disturbance recorder and event logger) in proper working condition.
2. The disturbance recorders shall have time synchronization and a standard format for recording analogue and digital signals which shall be included in the guidelines issued by the respective RPCs.
3. The time synchronization of the disturbance recorders shall be corroborated with the PMU data or SCADA event loggers by the respective RLDC. Disturbance recorders which are non-compliant shall be listed out for discussion at RPC.

## **Annexure – 5: Third Party Protection System Checking & Validation Template for a Substation (IEGC 2023 Annexure – 1)**

### **1. Introduction:**

- a. The audit reports, along with action plan for rectification of deficiencies found, if any, shall be submitted to RPC or RLDC within a month of submission of report by auditor.
- b. The third-party protection system checking shall be carried at site by the designated agency. The agency shall furnish two reports:
  - i. Preliminary Report: This report shall be prepared on the site and shall be signed by all the parties present.
  - ii. Detailed Report: This report shall be furnished by agency within one month after carrying out detailed analysis.

### **2. Checklist:**

- a. The protection system checklist shall contain information as per this Regulation.
  - i. General Information (to be provided prior to the checking as well as to be included in final report):
    - Substation name
    - Name of Owner Utility
    - Voltage Level (s) or highest voltage level
    - Short circuit current rating of all equipment (for all voltage level) (v) Date of commissioning of the substation
    - Checking and validation date
    - Record of previous tripping's (in last one year) and details of protection operation
    - Previous Relay Test Reports
    - Overall single line diagram (SLD) (x) AC aux SLD
    - DC aux SLD
    - SAS architecture diagram
    - SPS scheme implemented (if any)



b. The preliminary report shall inter-alia contain the following:

**FORMAT OF PRELIMINARY REPORT**

S. No.	Issues	Remarks
<b>1</b>	<b>Recommendation of last protection checking and validation</b>	Status of works & pending issues if any
<b>2</b>	<b>Review of existing settings at substation</b>	Recommended Action
<b>3</b>	<b>Disturbance Recorder out/ available for last 6 trippings (Y/N)</b>	Recommended Action
<b>4</b>	<b>Chronic reason of tripping, if any</b>	Recommended Action
<b>5</b>	<b>Major non-conformity/deficiency observed</b>	Recommended Action

c. The **relay configuration check-list** for available power system elements at station:

- Transmission Line
- Bus Reactor/Line Reactor
- Inter-connecting Transformer
- Busbar Protection Relay
- AC auxiliary system
- DC auxiliary system
- Communication system
- Circuit Breaker Details
- Current Transformer details
- Capacitive Voltage Transformers Details
- Any other equipment/system relevant for protection system operation

d. The **minimum set of points on which checking & validation** shall be carried out is covered in this clause. The detailed list shall be prepared by checking and validation team in consultation with concerned entity, RLDC and RPC.

**i. Transmission Line Distance Protection/Differential Protection;**

- Name and Length of Line
- Whether series compensated or not
- Mode of communication used (PLCC/OPGW)
- Relay Make and Model for Main-I and Main-II

- List of all active protections & settings
- Carrier aided scheme if any
- Status of Power Swing/Out of Step/SOTF/Breaker Failure/Broken Conductor/STUB/Fault Locator/DR/VT fuse fail/Overvoltage Protection/Trip Circuit supervision/Auto-reclose/Load encroachment etc.
- Relay connected to Trip Coil-1 or 2 or both i. CT ratio and PT ratio
- Feed from DC supply-1 or 2
- Connected to dedicated CT core (mention name)
- Other requirements for protection checking and validation

**ii. Shunt Reactor & Inter-connecting Transformer (ICT) Protection;**

- Whether two groups of protections used (Group A and Group B)
- Do the groups have separate DC sources
- Relay Make and Model
- List of all active protections along with settings
- Status of Differential Protection/Restricted Earth Fault Protection/Back-up Directional Overcurrent/Backup Earth fault/ Breaker Failure
- Status of Oil Temperature Indicator/Winding-Temperature Indicator/Bucholz/Pressure Release Device etc.
- Relay connected to Trip Coil-1 or 2 or both
- CT ratio and PT ratio
- Feed from DC supply-1 or 2
- Connected to dedicated CT core (mention name)
- Other requirements for protection checking and validation

**iii. Busbar Protection Relay;**

- Busbar and redundant relay make and model
- Type of Busbar arrangement
- Zones
- Dedicated CT core for each busbar protection (Yes/No)
- Breaker Failure relay included (Yes/No), if additional then furnish make and model
- Trip issued to both Busbar protection in case of enabling
- Isolator indication and check relays
- Other requirements for protection checking and validation

**iv. AC auxiliary system;**

- Source of AC auxiliary system
- Supply changeover between sources (Auto/Manual)
- Diesel generator (DG) details
- Maintenance plan and supply changeover periodicity in DG
- Single Line Diagram
- Other requirements for protection checking and validation

**v. DC auxiliary system;**

- Type of Batteries (Make, vintage, model)
- Status of battery Charger
- Measured voltage (positive to earth and negative to earth)
- Availability of ground fault detectors
- Protection relays and trip circuits with independent DC sources
- Other requirements for protection checking and validation
- Communication system
  - Mode of communication for Main-1 and Main-2 protection
  - Mode of communication for data and speech communication
  - Status of PLCC channels
  - Time synchronization equipment details
  - 7OPGW on geographically diversified paths for Main-1 and main-2 relay
  - Other requirements for protection checking and validation

**vi. Circuit Breaker Details;**

- Details and Status
- Healthiness of Tripping Coil and Trip circuit supervision relay
- Single Pole/Multi pole operation
- Pole Discrepancy Relay available (Y/N)
- Monitoring Devices for checking the dielectric medium
- Other requirements for protection checking and validation
- Current Transformer (CT)/Capacitive Voltage Transformer (CVT) Details
  - CT/CVT ID name and voltage level
  - CT/CVT core connection details
  - Accuracy Class

- Whether Protection/Metering
- CT/CVT ratio available and ratio adopted
- Details of last checking and validation of CT/CVT healthiness
- Other requirements for protection checking and validation
- Other protections: Direction earth fault, negative sequence, over current, over voltage, over frequency, under voltage, under frequency, forward power, reverse power, out of step/power swing, HVDC protection etc.

### 3. Summary of checking:

The summary shall specifically mention minimum following points:

- a) The settings and scheme adopted are in line with agreed protection philosophy or any accepted guidelines (e.g. Ramakrishna guidelines or CBIP manual based).
- b) The deviations from the RPC protection philosophy, if any and reasons for taking the deviations shall be recorded.
- c) All the major general deficiency shall be listed in detail along with remedial recommendations.
- d) The relay settings to be adopted shall be validated with simulation based or EMTP studies and details shall be enclosed in report.
- e) The cases of protection maloperation shall be analysed from protection indices report furnished by concerned utility, the causes of failure along with corrective actions and recommendations based on the findings shall be noted in the report.

## Annexure – 6: Protection Philosophy/Protocol of Northern Region

The Protection Philosophy/Protocol of Northern Region is developed in compliance of IEGC 2023, Version 2.0 which was approved in 71<sup>st</sup> NRPC meeting held on 29.01.2024.

S.N.	Protection Setting/Protocol	Mandated Setting for transmission lines
1	<b>Protection Scheme</b>	<p>220KV and above: Independent Main-I and Main-II protection (of different make OR different type/different algorithm) of non-switched numerical type is to be provided with carrier aided scheme.</p> <p>132KV and below: One non-switched distance protection scheme and, directional over current and earth fault relays, should be provided as back up.</p>
2	<b>Distance Protection Zone-1</b>	<p>Reach: 80% of the protected line; 110% of the protected line (In case of radial lines) Time Setting: Instantaneous.</p>
3	<b>Distance Protection Zone-2</b>	<p>Reach: Single Circuit Line: 120% of length of principle line section. Double circuit line: 150% coverage of line to take care of under reaching due to mutual coupling effect.</p> <p>Time setting: i. 0.35 second <i>(considering LBB time of 200mSec, CB open time of 60ms, resetting time of 30ms and safety margin of 60ms)</i> ii. 0.5-0.6 second <i>(For a long line followed by a short line)</i></p>

S.N.	Protection Setting/Protocol	Mandated Setting for transmission lines
4	<b>Distance Protection Zone-3</b>	<p>Reach: Zone-3 should overreach the remote terminal of the longest adjacent line by an acceptable margin (typically 20% of highest impedance seen) for all fault conditions.</p> <p>Time Setting: 800-1000 msec</p> <p>If zone-3 reach transcends to other voltage level, time may be taken up to 1.5 sec.</p>
5	<b>Distance Protection Zone- 4</b>	<p>The Zone-4 reverse reach must adequately cover expected levels of apparent bus bar fault resistance.</p> <p>Time may be coordinated accordingly.</p> <p>Where Bus Bar protection is not available, time setting: 160 msec.</p>
6	<b>Lines with Series and other compensations in the vicinity of Substation</b>	<ul style="list-style-type: none"> <li>• Zone-1: FSC end: 60% of the protected line. Time: Instantaneous; Remoted end: 60% of the protected line with 100ms-time delay. POR Communication scheme logic is modified such that relay trips instantaneously in Zone-1 on carrier receive.</li> <li>• Zone-2: 120 % of uncompensated line impedance for single circuit line. For Double circuit line, settings may be decided on basis of dynamic study in view of zero sequence mutual coupling.</li> <li>• Phase locked voltage memory is used to cope with the voltage inversion. Alternatively, an intentional time delay may be applied to overcome directionality problems related to voltage inversion.</li> <li>• Over-voltage stage-I setting for series compensated double circuit lines may be kept higher at 113%.</li> </ul>

S.N.	Protection Setting/Protocol	Mandated Setting for transmission lines
7	<b>Power Swing Blocking</b>	<ul style="list-style-type: none"> <li>• Block tripping in all zones, all lines.</li> </ul> Out of Step tripping to be applied on all inter-regional tie lines. Deblock time delay = 2s
8	<b>Protection for broken conductor</b>	Negative Sequence current to Positive Sequence current ratio more than 0.2 (i.e. $I_2/I_1 \geq 0.2$ ) Alarm Time delay: 3-20 sec. Tripping may be considered for radial lines to protect single phasing of transformers.
9	<b>Switch on to fault (SOTF)</b>	Switch on to fault (SOTF) function to be provided in distance relay to take care of line energization on fault.
10	<b>VT fuse fail detection function</b>	VT fuse fail detection function shall be correctly set to block the distance function operation on VT fuse failure.
11	<b>Carrier Protection</b>	To be applied on all 220KV and above lines with the only exception of radial feeders.
12	<b>Back up Protection</b>	<ol style="list-style-type: none"> <li>1. On 220KV and above lines with 2 Main Protections:               <ul style="list-style-type: none"> <li>• Back up Earth Fault protections alone to be provided.</li> <li>• No Over current protection to be applied.</li> </ul> </li> <li>2. At 132KV and below lines with only one Main protection:               <ul style="list-style-type: none"> <li>• Back up protection by IDMT O/C and E/F to be applied.</li> </ul> </li> </ol>

S.N.	Protection Setting/Protocol	Mandated Setting for transmission lines
13	<b>Auto Reclosing with dead time.</b>	<p>AR shall be enabled for 220 KV and above lines for single pole trip and re-closing. Dead time = 1.0s. Reclaim time = 25.0s</p> <p>Auto-recloser shall be blocked for following:</p> <ul style="list-style-type: none"> <li>• Faults in cables</li> <li>• Breaker Fail Relay</li> <li>• Line Reactor Protections</li> <li>• O/V Protection</li> <li>• Received Direct Transfer trip signals</li> <li>• Busbar Protection</li> <li>• Zone 2/3 of Distance Protection</li> <li>• Circuit Breaker Problems.</li> </ul> <p>CB Pole discrepancy relay time:1.5 sec; for tie breaker: 2.5 sec</p>
14	<b>Busbar protection</b>	To be applied on all 220KV and above sub stations with the only exception of 220KV radial fed bus bars.
15	<b>Local Breaker Backup (LBB)</b>	<p>For 220 KV and above level substations as well as generating stations switchyards, LBB shall be provided for each circuit breaker.</p> <p>LBB Current sensor I &gt; 20% In LBB time delay = 200ms</p> <p>In case of variation in CT ratio, setting may be done accordingly.</p>
16	<b>Line Differential</b>	<p>For cables and composite lines, line differential protection with built in distance back up shall be applied as Main-I protection and distance relay as Main-II protection.</p> <p>For very short line (less than 10 km), line differential protection with distance protection as</p>



S.N.	Protection Setting/Protocol	Mandated Setting for transmission lines
		<p>backup (built- in Main relay or standalone) shall be provided mandatorily as Main-I and Main-II.</p> <p>Differential protection may be done using dark fiber (preferably), or using bandwidth.</p>
17	Over Voltage Protection	<p>FOR 765KV LINES/CABLE:  Low set stage (Stage-I): 106% - 109% (typically 108%) with a time delay of 5 seconds.  High set stage (Stage-II): 140% - 150% with a time delay of 100 milliseconds.</p> <p>400KV LINES/CABLE:  Low set stage (Stage-I): 110% - 112% (typically 110%) with a time delay of 5 seconds.  High set stage (Stage-II): 140% - 150% with a time delay of 100 milliseconds.</p> <p>FOR 220KV LINES:  No over-voltage protection shall be used.</p> <p>FOR 220KV CABLE:  Low set stage (Stage-I): 110% - 112% (typically 110%) with a time delay of 5 seconds.  High set stage (Stage-II): 140% - 150% with a time delay of 100 milliseconds.</p> <p>Drop-off to pick-up ratio of overvoltage relay:  better than 97%</p> <p>Grading: Voltage as well as time grading may be done for multi circuit lines/cable.</p>

S.N.	Protection Setting/Protocol	Mandated Setting for transmission lines
18	<b>Resistive reach setting to prevent load point encroachment</b>	<p>Following criteria may be considered for deciding load point encroachment:</p> <ul style="list-style-type: none"> <li>• Maximum load current (<math>I_{max}</math>) may be considered as 1.5 times the thermal rating of the line or 1.5 times the associated bay equipment current rating (the minimum of the bay equipment individual rating) whichever is lower. (Caution: The rating considered is approximately 15minutes rating of the transmission facility).</li> <li>• Minimum voltage (<math>V_{min}</math>) to be considered as 0.85pu (85%).</li> </ul>
19	<b>Direct Inter-trip</b>	<p>To be sent on operation of following:</p> <ol style="list-style-type: none"> <li>i. Overvoltage Protection</li> <li>ii. LBB Protection</li> <li>iii. Busbar Protection</li> <li>iv. Reactor Protection</li> <li>v. Manual Trip (400KV and above)</li> <li>vi. Cable Fault (in composite lines)</li> </ol>
20	<b>Permissive Inter-trip</b>	To be sent on operation of Distance Protection

## Annexure – 7: Work Order & Corrigendum



पावर ट्रांसमिशन कारपोरेशन ऑफ उत्तराखण्ड लि0  
(उत्तराखण्ड सरकार का उपक्रम)  
अधीक्षण अभियन्ता (परीक्षण एवं परिचालन एवं स्काडा) कार्यालय  
कुमांयु मण्डल हल्द्वानी  
मोबाइल नं0 9412089275, ईमेल dp\_singh@ptcul.org

No. 376 /SE (T&C)/PTCUL/ (H)/

Date:29.09.2023

Subject:- Order for Protection Audit of 02 Nos 400 kV and 08 Nos 220KV sub-stations in PTCUL.

Joint Advisor

Central Board of Irrigation and Power

Malcha Marg Chanakyapuri,

New Delhi-110021

Email: mrchauhan@cbip.org.

Dear Sir,

In reference to your offer submitted vide Ref No: P-1/CBIP/PTCUL/PTCUL/Audit/2023 dated: 11.09.2023 through email against Email enquiry dated 05.09.2023, an order is hereby placed in favour of your firm for the work of "Protection Audit of 02 Nos 400kV and 08 Nos 220 kV substations of PTCUL" The detail of material, price schedule and terms & conditions is here as under:-

Sr.No	Description	Unit	Qty	Amount	Total Amount
1	Protection Audit to be carried out for the following 10 nos of the 400/220kV substations of PTCUL :- 1. 400kV S/s Rishikesh 2. 400 kV S/s Kashipur 3. 220kV S/s Chamba 4. 220kV S/s Rishikesh 5. 220kV S/s Roorkee 6. 220kV S/s Haridwar (SIDCUL) 7. 220kV S/s Jhajra. 8. 220 kV S/s Pantnagar. 9. 220 kV S/s Haldwani. 10. 220kV S/s Mahuakheraganj.	Job	1	36,25,000	36,25,000
TOTAL					36,25,000

Total value of order is Rs.36,25,000 (Rupees Thirty Six Lakh Twenty Five Thousand only ) Plus GST Extra.

End: 1. Terms & Conditions.

Please acknowledge the receipt and acceptance of order.

(D.P Singh)

Superintending Engineer (T&C), Haldwani

No.376 /SE (T&C)/PTCUL/ (H)/

Date:29.09.2023

Copy forwarded to the following for information and necessary action:-

1. Director (Operation), PTCUL, Dehradun.
2. Superintending Engineer (A) MD, PTCUL, Dehradun.
3. Chief Engineer, T&C PTCUL, 132kV Substation Campus, Kathgodam Nainital.
4. Executive Engineer, T&C Division, Kashipur.
5. Director (Energy), Central Board of Irrigation and Power Malcha Marg Chanakyapuri, New Delhi-110021 Email: [sanjeev@cbip.org](mailto:sanjeev@cbip.org)

(D.P Singh)

Superintending Engineer (T&C), Haldwani

मुख्यालय एवंपंजीकृत कार्यालय:-विद्युतमवन, नजदीक-आई0एस0बी0टी0 क्रासिंग, सहारनपुररोड, माजरा, देहरादून-248002  
कारपोरेटआईडी नं0: U40101UR2004GOI028675 दूरभाष नं0 0135-2646000 फॅक्स नं0 0135-2643460 वेबसाइट [www.ptcul.org](http://www.ptcul.org)



पावर ट्रांसमिशन कारपोरेशन ऑफ उत्तराखण्ड लि0  
(उत्तराखण्ड सरकार का उपक्रम)  
अधीक्षण अभियन्ता (परीक्षण एवं परिचालन एवं स्काडा) कार्यालय  
कुमायु मण्डल हल्द्वानी  
मोबाइल नं0 9412089275, ईमेल dp\_singh@ptcul.org

Terms & Conditions:-

1	Scope	<p>: The detailed Scope work is as under:</p> <ol style="list-style-type: none"><li>1. There must be a kick off meeting for discussion on project plan before start of the work in field and the detailed plan of performance shall be submitted by CBIP.</li><li>2. Requisite data shall be collected in standard format from PTCUL grid substations by authorized and experienced auditor.</li><li>3. The site surveys and audit of grid substations of PTCUL shall be done by authorized and experienced auditor.</li><li>4. Review of the implemented protection schemes/philosophy for 400/220 kV substations which includes protection of transmission lines,interconnecting transformers, line/busreactors, bus bar, bus couplers etc.as per latest guidelines of Ramakrishna committee/CBIP/NRPC/Intenational best practices.etc.</li><li>5. Review the adequacy of primary and backup protection settings for protected equipment and suggest corrective measures where evernon compliance with respect to Ramakrishna committee/ CBIP/NRPC is found during the protection audit.</li><li>6. Review of availability/healthiness of PLCC communication links used for protection systems.</li><li>7. Review the healthiness/adequacy of 220/110/50V DC system available at substations for protection application.</li><li>8. Review of availability/healthiness of GPS system and time synchronization facility used for protection.</li><li>9. Review of availability/healthiness of recording instruments like DRs /ELs for transmission lines protection.</li><li>10. Review of test reports for assessing the healthiness of circuit breakers, CT &amp; CVT based upon available test reports at sites.</li><li>11. Field inspection of protection device for obsolescence of technology, suitability and healthiness.</li><li>12. Directory of the protection system &amp; recommendation for replacement of obsolescence relays with compatible numerical relays will be provided.</li><li>13. Checking of availability of DGset/auxiliary DC supply at substations.</li><li>14. Site visits for onsite protection audit, review and inspection of substations will be performed.</li><li>15. Submission of the detailed report for the protection audit including the protection philosophy, reviewed settings and protection audit observations.</li><li>16. The performance of above protection equipment like relays, circuit breaker, CT, CVT, DC battery bank, synchro facility, communication facility used for protection will be also checked through physical inspection and provided test reports/documents. These protection equipments will be recommended for renovation and upgradation based on their performance accessed during protection audit and physical inspection.</li><li>17. Review the availability healthiness of<ul style="list-style-type: none"><li>• Event recorders/ loggers' operation history</li><li>• CT, CVT, CB</li><li>• DC power supply</li><li>• Auxiliary supply</li><li>• Communication links</li><li>• Time synchronization/ GPS</li></ul></li><li>18. Review of Testing and Maintenance records of all protective relays, Circuit Breakers CT, CVT etc. Review of protection philosophy.</li></ol>
---	-------	--

मुख्यालय एवंपंजीकृत कार्यालय:-विद्युतमवन, नजदीक-आई0एस0बी0टी0 क्रासिंग, सहारनपुररोड, माजरा, देहरादून-248002  
कारपोरेटआईडी नं0: U40101UR2004GOI028675 दूरभाष नं0 0135-2646000 फॅक्स नं0 0135-2643460 वेबसाइटwww.ptcul.org





पावर ट्रांसमिशन कारपोरेशन ऑफ उत्तराखण्ड लि०  
(उत्तराखण्ड सरकार का उपक्रम)  
अधीक्षण अभियन्ता (परीक्षण एवं परिचालन एवं स्काडा) कार्यालय  
कुमायु मण्डल हल्द्वानी  
मोबाइल नं० 9412089275, ईमेल dp\_singh@ptcul.org

			19. Anything which is left to be mentioned here but required for successful completion of the aforementioned subject work shall be done <b>Central Board of Irrigation and Power Malcha Marg Chanakyapuri, New Delhi-110021</b> 20. CBIP Delhi shall submit a report on detailed points in four sets of hard copy duly spiraled binding as well as soft copy shall be submitted. 21. The safety guidelines prevalent in PTCUL must be followed.
2	GST	:	GST shall be paid extra as per applicable Government rules.
3	Tax	:	Tax shall be deducted at source as per applicable Government rules. A certificate to this effect may be given to the Contractor if required.
4	Date of Start of work	:	Order shall be considered as having come in to force from the date of issue of order.
5	Supply Completion	:	NA
6	Work completion	:	The work should be completed within 24 months from the date of issue of order.
7	Engineer of the contract		Superintending Engineer (T&C), Haldwani is the "Engineer of the contract" who shall be placing the order for the work with the contractor and signing the contract agreement and who has been inherently vested with such powers by corporation in this behalf and shall act as Engineer for the purpose of the contract.
8	Engineer in-charge		Respective Executive Engineer (T&C) shall be "Engineer in charge" for the subject work.
9	Liquidity damages	:	If the contract is delayed beyond the stipulated period mentioned in the contract. The liquidity damages shall be levied @ 0.5 % per week and maximum up to 10% of contract value.
10	Dispute		All Dispute arising out of this case under the jurisdiction local court at Kashipur and Honable High Court, Nainital.
11	Payment terms	:	1. 25% Payment will be made within 30 days after finalization of Audit plan, subject to availability of funds from PTCUL HQ. 2. 35% Payment will be made within 30 days after submission of preliminary reports verified by Executive Engineer of respective division, subject to availability of funds from PTCUL HQ. 3. 40 % Payment will be made within 30 days after submission of final reports verified by Executive Engineer of respective division, subject to availability of funds from PTCUL HQ.
12	Payment unit		Test & Commissioning Division, Kashipur shall be the payment unit and all units where is to be work done shall record the measurement and duly passed bills along with measurement book shall be submitted to payment unit.
13	Warranty period	:	NA.
14	Billing Address	:	Executive Engineer Test & Commissioning Division, PTCUL 400 KV Substation Campus, Kashipur (Uttarakhand)-244713, GSTIN No. (05AAECM1785FC29)

All other term and condition of this order shall be governed by the General conditions of the contract prevalent in PTCUL.

(D.P Singh)

Superintending Engineer(T&C), Haldwani

मुख्यालय एवंपंजीकृत कार्यालय:-विद्युतमवन, नजदीक-आई०एस०बी०टी० क्रासिंग, सहारनपुररोड, गाजरा, देहरादून-248002  
कारपोरेटआईडी नं०: U40101UR2004GOI028675 दरमारा नं० 0135-2646000 फ़ैक्स नं० 0135-2643460 वेबसाइटwww.ptcul.org



पावर ट्रांसमिशन कारपोरेशन ऑफ उत्तराखण्ड लि०  
(उत्तराखण्ड सरकार का उपक्रम)  
अधीक्षण अभियन्ता (परीक्षण एवं परिचालन एवं स्काडा) कार्यालय  
कुमायु मण्डल हल्द्वानी  
मोबाइल नं० 9412089275, ईमेल dp\_singh@ptcul.org

No. 394 /SE (T&C)/PTCUL/ (H)/

Date:26.10.2023

Subject:- Corrigendum for the Order for the work of Protection Audit of 02 Nos 400 kV and 08 Nos 220KV sub-stations in

PTCUL

Joint Advisor

Central Board of Irrigation and Power

Malcha Marg Chanakyapuri,

New Delhi-110021

Email: mrchauhan@cbip.org.

Dear Sir,

In reference to above mentioned subject, please refer to kick off meeting held on dated 26.10.2023 for the work of Protection Audit of 02 Nos 400 kV and 08 Nos 220KV sub-stations in PTCUL against order no.376 dated 29.09.2023.

In this regard, kindly find enclosed herewith corrigendum of order no.376 dated 29.09.2023 (Annexure-1) with necessary amendments as discussed in afforementioned meeting.

This is for your kind information and necessary action.

Please acknowledge the receipt and acceptance of order.

(D.P Singh)

Superintending Engineer (T&C), Haldwani

Copy forwarded to the following for information and necessary action:-

1. Chief Engineer, T&C PTCUL, 132kV Substation Campus, Kathgodam Nainital..
2. Executive Engineer, T&C Division, Roorkee/Dehradun/Haldwani/Kashipur/Rishikesh with request to provide assistance and information to CBIP for the above work.
3. Director (Energy), Central Board of Irrigation and Power Malcha Marg Chanakyapuri, New Delhi-110021  
Email: [sanjeev@cbip.org](mailto:sanjeev@cbip.org)

मुख्यालय एवंपंजीकृत कार्यालय:-विद्युतमवन, नजदीक-आई०एस०बी०टी० क्रॉसिंग, सहारनपुररोड, माजरा, देहरादून-248002  
कारपोरेटआईडी नं०: U40101UR2004GOI028675 दूरभाष नं० 0135-2646000 फैंक्स नं० 0135-2643460 वेबसाइट [www.ptcul.org](http://www.ptcul.org)

Annexure -1 – Work order corrigendum

Scope: The detailed Scope work is as under:

S. No.	Clause of PO	Existing Clause					Modified Clause						
		Sr. No	Description	Unit	Qty	Amount	Total Amount	Sr. No	Description	Unit	Qty	Unit rate (Rs.)	Total Amount (Rs.)
1	Price Schedule	1	Protection Audit to be carried out for the following 10 nos. of the 400/220kV substations of PTCUL - 1. 400kV S/s Rishikesh 2. 400 KV S/s Kashipur 3. 220kV S/s Chamba 4. 220kV S/s Rishikesh 5. 220kV S/s Roorkee 6. 220kV S/s Haridwar (SIDCUL) 7. 220kV S/s Jhajra 8. 220 KV S/s Pantnagar 9. 220 KV S/s Haldwani 10. 220kV S/s Mahaukheragani.	Job	1	36,25,000	36,25,000	1	Protection Audit to be carried out for the following 10 nos of the 400/220kV substations of PTCUL - 1. 400kV S/s Rishikesh 2. 400 KV S/s Kashipur 3. 220kV S/s Chamba 4. 220kV S/s Rishikesh 5. 220kV S/s Roorkee 6. 220kV S/s Haridwar (SIDCUL) 7. 220kV S/s Jhajra 8. 220 KV S/s Pantnagar 9. 220 KV S/s Haldwani 10. 220kV S/s Mahaukheragani)	Each	10	3,62,500	36,25,000
		TOTAL					36,25,000	TOTAL					36,25,000
2	Terms and Conditions S. No. 1 – Scope	1.	There must be a kick off meeting for discussion on project plan before start of the work in field and the detailed plan of performance shall be submitted by CBIP.					1. There must be a kick off meeting for discussion on project plan before start of the work in field and the detailed plan of performance shall be submitted by CBIP.					
		2.	Requisite data shall be collected in standard format from PTCUL grid substations by authorized and experienced auditor.					2. Requisite data shall be collected in standard format from PTCUL grid substations by an experienced auditor.					
		3.	The site surveys and audit of grid substations of PTCUL shall be done by authorized and experienced auditor.					3. The site surveys and audit of grid substations of PTCUL shall be done by an experienced auditor.					
		4.	Review of the implemented protection schemes/ philosophy for 400/220 kV substations which includes protection of transmission lines, interconnecting lines, interconnecting transformers, line/bus reactors, bus bar, bus couplers etc with respect to					4. Review of the implemented protection schemes/philosophy for 400/220 kV substations which includes protection of transmission lines, interconnecting transformers, line/bus reactors, bus bar, bus couplers etc with respect to					









S. No.	Clause of PO	Existing Clause	Modified Clause
		couplers etc.as per latest guidelines of Ramakrishna committee/CBIP/NRPC/international best practices, etc.	tripping in last one year as per latest guidelines of Ramakrishna committee/CBIP/NRPC/international best practices, which includes review of the following:
5.	Review the adequacy of primary and backup protection settings for protected equipment and suggest corrective measures where everyone compliance with respect to Ramakrishna committee/ CBIP/NRPC is found during the protection audit.	Review the adequacy of primary and backup protection settings for protected equipment and suggest corrective measures where everyone compliance with respect to Ramakrishna committee/ CBIP/NRPC is found during the protection audit.	a) Adequacy of primary and backup protection settings for protected equipment and suggest corrective measures
6.	Review of availability/healthiness of PLCC communication links used for protection systems.	Review of availability/healthiness of PLCC communication links used for protection systems.	b) Availability/healthiness of PLCC communication links used for protection systems.
7.	Review the healthiness/adequacy of 220/110/50V DC system available at substations for protection application.	Review the healthiness/adequacy of 220/110/50V DC system available at substations for protection application.	c) Healthiness/adequacy of 220/110/50V DC system available at substations for protection application.
8.	Review of availability/healthiness of GPS system and time synchronization facility used for protection.	Review of availability/healthiness of GPS system and time synchronization facility used for protection.	d) Availability/healthiness of GPS system and time synchronization facility used for protection.
9.	Review of availability/healthiness of recording instruments like DRs /ELs for transmission lines protection.	Review of availability/healthiness of recording instruments like DRs /ELs for transmission lines protection.	e) Availability/healthiness of recording instruments like DRs /ELs for transmission lines protection.
10.	Review of test reports for assessing the healthiness of circuit breakers, CT & CVT based upon available test reports at sites.	Review of test reports for assessing the healthiness of circuit breakers, CT & CVT based upon available test reports at sites.	f) Test reports for assessing the healthiness of circuit breakers, CT & CVT based upon available test reports at sites.
11.	Field inspection of protection device for obsolescence of technology, suitability and healthiness.	Field inspection of protection device for obsolescence of technology, suitability and healthiness.	g) Field inspection of protection device for obsolescence of technology, suitability and healthiness.
12.	Directory of the protection system & recommendation for replacement of obsolescence relays with compatible numerical relays will be provided.	Directory of the protection system & recommendation for replacement of obsolescence relays with compatible numerical relays will be provided.	h) Prepare recommendation for replacement of obsolescence relays with compatible numerical relays will be provided.
13.	Checking of availability of DG Set/auxiliary DC supply at substations.	Checking of availability of DG Set/auxiliary DC supply at substations.	i) Checking of availability of DG Set / auxiliary DC supply at substations.
14.	Site visits for onsite protection audit, review and inspection of substations will be performed.	Site visits for onsite protection audit, review and inspection of substations will be performed.	5. Site visits for onsite protection audit, review and inspection of substations will be performed
15.	Submission of the detailed report for the protection audit including the protection philosophy, reviewed settings and protection audit observations.	Submission of the detailed report for the protection audit including the protection philosophy, reviewed settings and protection audit observations.	6. Submission of the detailed report for the protection audit including the protection philosophy, reviewed settings and protection audit observations.
16.	The performance of above protection equipment like relays, circuit breaker, CT, CVT, DC battery bank, synchro facility, communication facility used for protection will be also checked through physical inspection and provided test reports/documents. These protection equipment's will be recommended for renovation and upgradation based on their performance accessed during protection audit and physical inspection.	The performance of above protection equipment like relays, circuit breaker, CT, CVT, DC battery bank, synchro facility, communication facility used for protection will be also checked through physical inspection and provided test reports/documents. These protection equipment's will be recommended for renovation and upgradation based on their performance accessed during protection audit and physical inspection.	Deleted as it is covered in point 4 above.







S. No.	Clause of PO	Existing Clause	Modified Clause
		<p>17. Review the availability healthiness of</p> <ul style="list-style-type: none"> <li>• Event recorders/ loggers' operation history</li> <li>• CT, CVT, CB</li> <li>• DC power supply</li> <li>• Auxiliary supply</li> <li>• Communication links</li> <li>• Time synchronization/ GPS</li> </ul> <p>18. Review of Testing and Maintenance records of all protective relays, Circuit Breakers, CT, CVT etc. Review of protection philosophy.</p> <p>19. Anything which is left to be mentioned here but required for successful completion of the aforementioned subject work shall be done Central Board of Irrigation and Power Marg Chanakyapuri, New Delhi-110021</p> <p>20. CBIP Delhi shall submit a report on detailed points in four sets of hard copy duly spiraled binding as well as soft copy shall be submitted.</p> <p>21. The safety guidelines prevalent in PTCUL must be followed.</p>	<p>7. Anything which is left to be mentioned here but required for successful completion of the aforementioned subject work shall be done by Central Board of Irrigation and Power.</p> <p>8. CBIP Delhi shall submit a protection report on detailed points in four sets of hard copy duly spiraled binding and in soft copy as well.</p> <p>9. The safety guidelines prevalent in PTCUL must be followed.</p>
3	Terms and Conditions – S. No. 6 - Work Completion	<p>The work should be completed within 24 months from the date of issue of order</p>	<p>The work should be completed within 24 weeks from the date of issue of corrigendum.</p>
4	Terms and Conditions – S. No. 8 - Engineer-in-charge	<p>Respective Executive Engineer (T&amp;C) shall be "Engineer in charge" for the subject work.</p>	<p>The following Executive Engineers (T&amp;C) shall be "Engineer in charge" for the subject work:</p> <p>a) 400KV Rishikesh, 220KV Rishikesh, 220 KV Chamba – Mr. Harsh Verma (Ph. No.9412074038 &amp; Email: ee_tandc_sh@ptcul.org).</p> <p>b) 400KV Kashipur, 220KV Pantnagar, 220KV Haldwani &amp; 220KV Mahuakheragan] – Mr. Asim Baig (Ph. No. 9412087885 &amp; Email: ee_tandc_asp@ptcul.org).</p> <p>c) 220KV SIDCUL Haridwar, 220 kv Roorkee – Mr. Ashwini Kumar (Ph. No.7088117301 &amp; Email: ee_tandc_ake@ptcul.org).</p> <p>d) 220KV Jhajra – Mr. Ravindra Kumar (Ph. No. 9927744222 &amp; Email: ee_tandc_ddun@ptcul.org).</p>



S. No.	Clause of PO	Existing Clause	Modified Clause
5	Terms and Conditions - S. No. 11 - Payment Terms	<ol style="list-style-type: none"> <li>1. 25% Payment will be made within 30 days after finalization of Audit plan, subject to availability of funds from PTCUL HQ.</li> <li>2. 35% Payment will be made within 30 days after submission of preliminary reports verified by Executive Engineer of respective division, subject to availability of funds from PTCUL HQ.</li> <li>3. 40 % Payment will be made within 30 days after submission of final reports verified by Executive Engineer of respective division, subject to availability of funds from PTCUL HQ.</li> </ol>	<ol style="list-style-type: none"> <li>1. 25% Payment will be made within 30 days after finalization of Audit plan, subject to availability of funds from PTCUL HQ.</li> <li>2. 35% Payment will be made within 30 days after submission of preliminary reports <b>on prorata basis</b> verified by Executive Engineer of respective division, subject to availability of funds from PTCUL HQ.</li> <li>3. 40 % Payment will be made within 30 days after submission of final reports <b>on prorata basis</b> verified by Executive Engineer of respective division, subject to availability of funds from PTCUL HQ.</li> <li>4. The local travel, lodging &amp; boarding shall be arranged by PTCUL on free-of-cost basis for CBIP team visiting the substation</li> </ol>







## **Annexure – 8: Data Sheets**

# Contents

<b>Single Line Diagrams</b> .....	65
<i>Substation Single Line Diagram</i> .....	65
<i>SAS Architecture diagram</i> .....	66
<b>Transmission Lines</b> .....	68
<b>Bus-Bar Protection</b> .....	74
<b>AC Auxiliary System</b> .....	75
<b>DC Auxiliary System</b> .....	76
<b>Circuit Breakers</b> .....	77
<b>Current Transformer</b> .....	79
<b>Capacitive Voltage Transformer/Potential Transformer</b> .....	87
<b>Transformer Protection</b> .....	94
<b>Network Diagram of Uttarakhand</b> .....	97
<b>Power Map of Uttarakhand</b> .....	98

# Protection Audit of 220/132/33kV Rishikesh Substation

## Annexure - 8

### Data Sheets

## Single Line Diagrams

### Substation Single Line Diagram

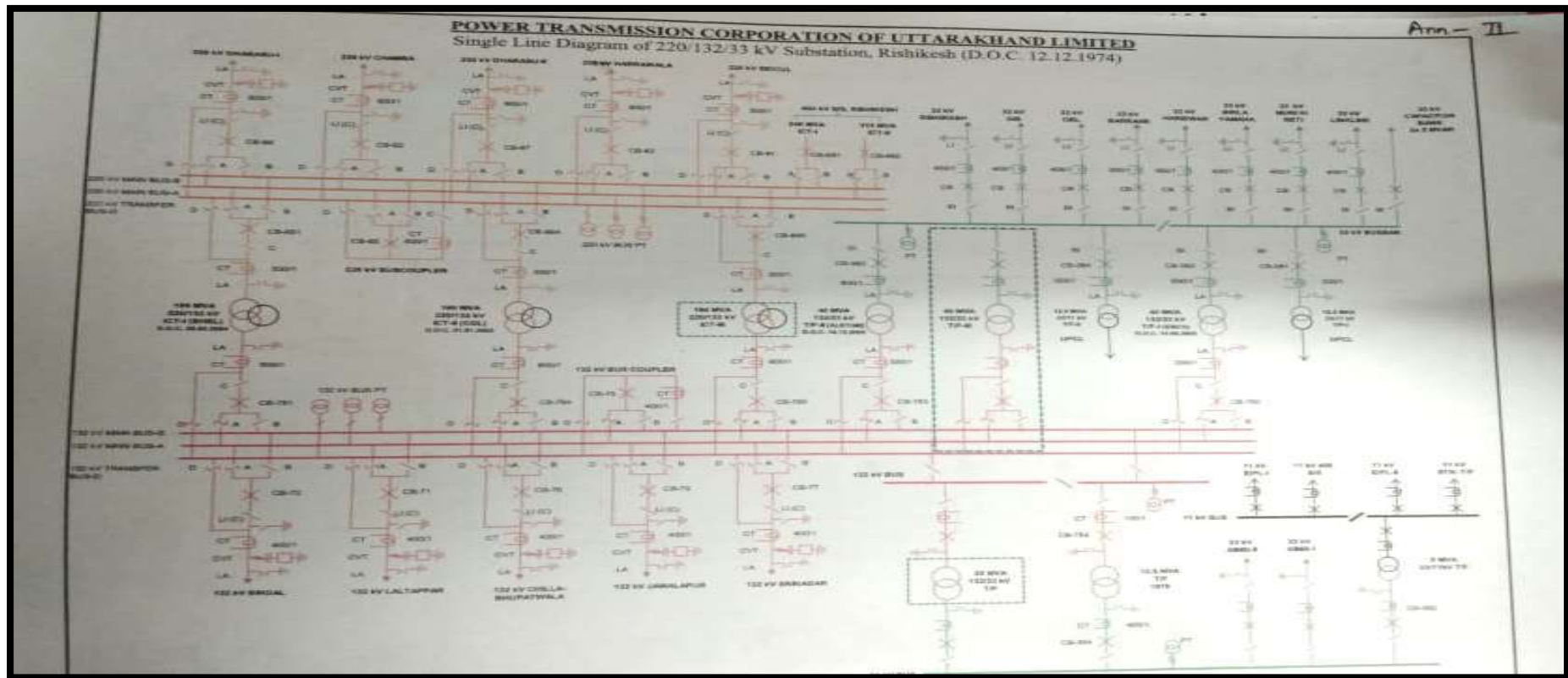

SAS Architecture diagram

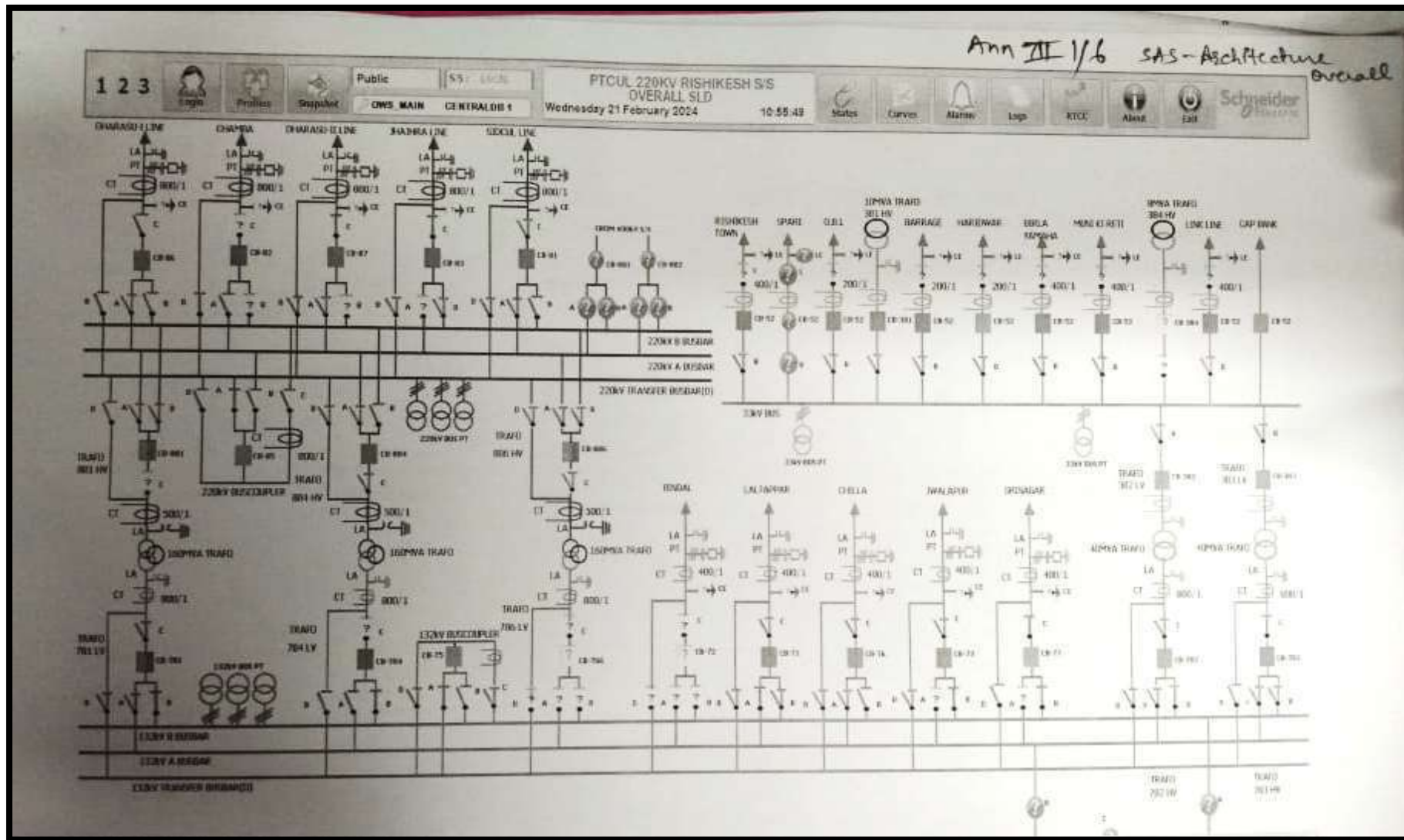



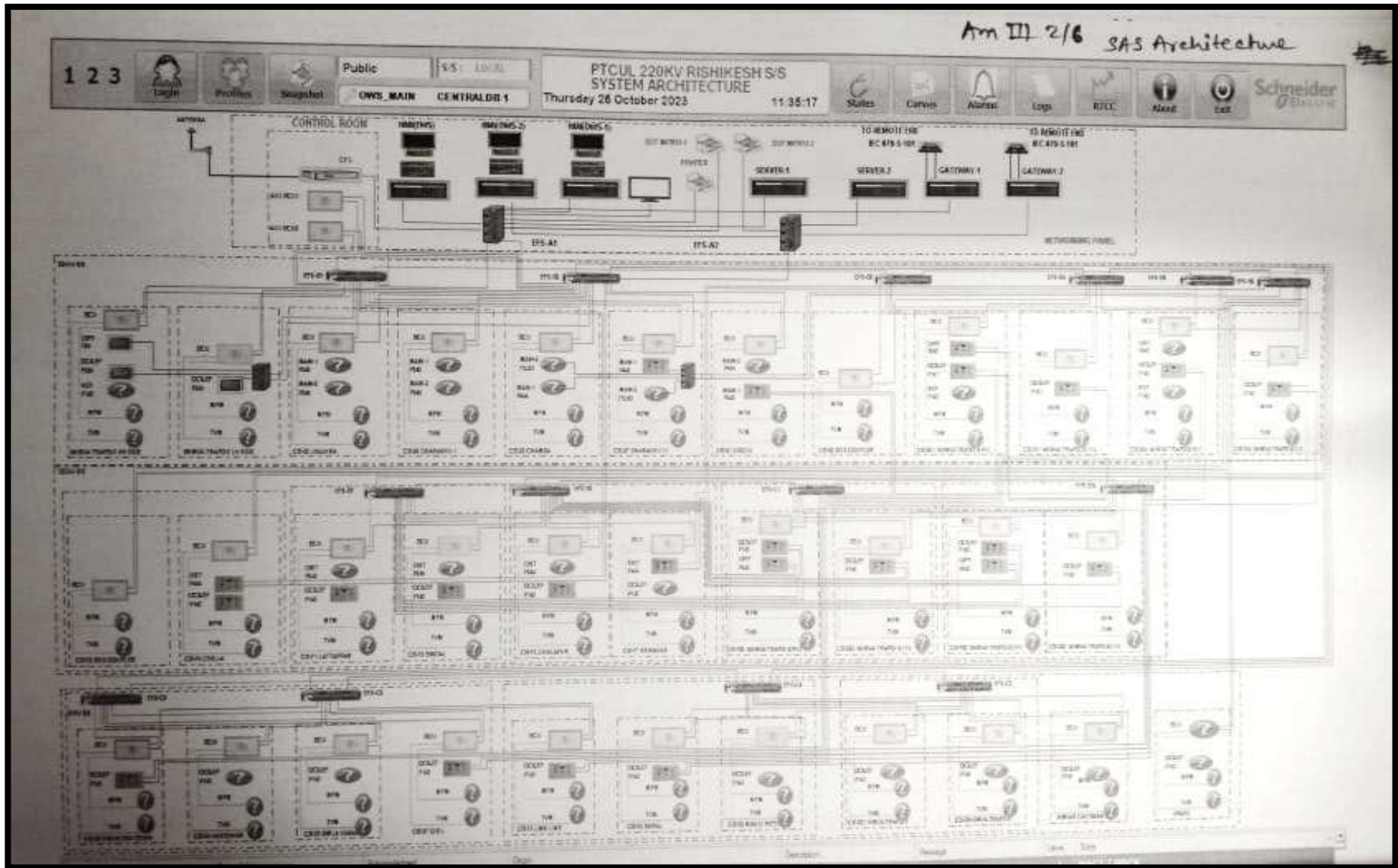

## Transmission Lines

220KV:

Particulars	Tr Line 1	Tr Line 2	Tr Line 3	Tr Line 4	Tr Line 5
<b>Name of Tr Line</b>	CB81 SIDCUL	CB82 Chamba	CB83 IIP	CB86 DharashuI	CB87 Dharashu II
<b>Length of Line</b>	23.97 km	40.00 km	31.00 km	79.50 km	80.40 km
<b>Series Compensated (Yes/No)</b>	No	No	No	No	No
<b>Connected to dedicated CT core (mention name)</b>	Core1: Dist. Prot Core2: Dir O/C & E/F	Core1: Dist. Prot Core2: Dir O/C & E/	Core1: Dist. Prot. Main I Core2: Dist. Prot. Main II	Core1: Dist. Prot Core2: Dir O/C & E/	Core1: Dist. Prot. Main I Core2: Dist. Prot. Main II
<b>CT Ratio</b>	800/1	800/1	800/1	800/1	800/1
<b>Connected to dedicated PT core (mention name)</b>	Core1: Dist. Prot Core2: Dir O/C & E/F	Core1: Dist. Prot Core2: Dir O/C & E/	Core1: Dist. Prot. Main I Core2: Dist. Prot. Main II	Core1: Dist. Prot Core2: Dir O/C & E/	Core1: Dist. Prot. Main I Core2: Dist. Prot. Main II
<b>PT Ratio</b>	220 KV/ 110V	220 KV/ 110V	220 KV/ 110V	220 KV/ 110V	220 KV/ 110V
<b>Relay connected to Trip Coil-1 or 2 or both</b>	Both	Both	Both	Both	Both
<b>Feed from DC supply-1 or 2</b>	Both	Both	Both	Both	Both
<b>i</b> Main-I Protection (Make and Model)	Micom P444	Micom P444	Siemens7SA52	Siemens7SA52	Micom P442



Particulars		Tr Line 1	Tr Line 2	Tr Line 3	Tr Line 4	Tr Line 5
	Functional (Yes/No)	Yes	Yes	Yes	Yes	Yes
	Date of testing	03-11-2023	01-11-2023	25-10-2023	04-11-2023	04-11-2023
<b>ii</b>	Main-II Protection (Make and Model)	Siemens7SJ62	Siemens7SJ62	Siemens7SA612	Siemens7SA612	Siemens7SJ62
	Functional (Yes/No)	Yes	Yes	Yes	Yes	Yes
	Date of testing	03-11-2023	01-11-2023	25-10-2023	04-11-2023	04-11-2023
<b>iii</b>	LBB Protection (Make and Model)	NA	NA	NA	NA	NA
	Functional (Yes/No)	NA	NA	NA	NA	NA
	Date of testing	NA	NA	NA	NA	NA
<b>iv</b>	PLCC/ Protection coupler (Make and Model)	NA	NA	NA	NA	NA
	Functional (Yes/No)	NA	NA	NA	NA	NA
<b>v</b>	DR (Make &Model) (Make and Model)	NA	NA	NA	NA	NA
	Functional (Yes/No)	NA	NA	NA	NA	NA
<b>vi</b>	Time Synch.Unit (Make and Model)	SANDS GPS	SANDS GPS	SANDS GPS	SANDS GPS	SANDS GPS
	Functional (Yes/No)	Yes	Yes	Yes	Yes	Yes
<b>Other Protections</b>						
<b>1</b>	Status of Power Swing	Enable	Enable	Enable	Enable	Enable
<b>2</b>	Out of Step	Enable	Enable	Enable	Enable	Enable
<b>3</b>	SOTF	Enable	Enable	Enable	Enable	Enable
<b>4</b>	Breaker Failure	NA	NA	NA	NA	NA
<b>5</b>	Broken Conductor	Alarm	Alarm	Alarm	Alarm	Alarm

Particulars		Tr Line 1	Tr Line 2	Tr Line 3	Tr Line 4	Tr Line 5
<b>6</b>	STUB	NA	NA	NA	NA	NA
<b>7</b>	Fault Locator	Enable	Enable	Enable	Enable	Enable
<b>8</b>	Disturbance Recorder	Enable	Enable	Enable	Enable	Enable
<b>9</b>	VT fuse fail	Alarm	Alarm	Alarm	Alarm	Alarm
<b>10</b>	Overvoltage Protection	NA	NA	NA	NA	NA
<b>11</b>	Trip Circuit supervision	Stand Alone Relay	Stand Alone Relay	Stand Alone Relay	Stand Alone Relay	Stand Alone Relay
<b>12</b>	Auto-reclose	Enable	Enable	Enable	Enable	Enable
<b>13</b>	Load encroachment	NA	NA	NA	NA	NA

**132KV:**

Particulars		Tr Line 1	Tr Line 2	Tr Line 3	Tr Line 4	Tr Line 5
<b>Name of Tr Line</b>		CB71 Laltapper	CB72 Bindal	CB 73 Jwalapur	CB 76 Bhopatwala	CB77 Srinagar
<b>Length of Line</b>		27.00 km	44.77km	22.97km	15.00km	66.40km
<b>Series Compensated (Yes/No)</b>		No	No	No	No	No
<b>Connected to dedicated CT core (mention name)</b>		Core1: Dist. Prot Core2: Dir O/C & E/	Core1: Dist. Prot Core2: Dir O/C & E/	Core1: Dist. Prot Core2: Dir O/C & E/	Core1: Dist. Prot Core2: Dir O/C & E/	Core1: Dist. Prot Core2: Dir O/C & E/
<b>CT Ratio</b>		400/1	400/1	400/1	400/1	400/1
<b>Connected to dedicated PT core (mention name)</b>		Core1: Dist. Prot Core2: Dir O/C & E/F	Core1: Dist. Prot Core2: Dir O/C & E/F	Core1: Dist. Prot Core2: Dir O/C & E/F	Core1: Dist. Prot Core2: Dir O/C & E/F	Core1: Dist. Prot Core2: Dir O/C & E/F
<b>PT Ratio</b>		132 KV/ 110V	132 KV/ 110V	132 KV/ 110V	132 KV/ 110V	132 KV/ 110V
<b>Relay connected to Trip Coil-1 or 2 or both</b>		Both	Both	Both	Both	Both
<b>Feed from DC supply-1 or 2</b>		Both	Both	Both	Both	Both
<b>i</b>	Main-I Protection (Make and Model)	ABB REL511	ABB REL511	ABB REL511	Micom P444	Siemens7SA52
	Functional (Yes/No)	Yes	Yes	Yes	Yes	Yes

Particulars		Tr Line 1	Tr Line 2	Tr Line 3	Tr Line 4	Tr Line 5
	Date of testing	26-10-2023	26-10-2023	28-10-2023	28-10-2023	02-11-2023
ii	Main-II Protection (Make and Model)	SchneiderP143	SchneiderP143	SchneiderP143	SchneiderP143	Siemens7SJ62
	Functional (Yes/No)	Yes	Yes	Yes	Yes	Yes
	Date of testing	26-10-2023	26-10-2023	28-10-2023	28-10-2023	02-11-2023
iii	LBB Protection (Make and Model)	Not Available	Not Available	Not Available	Not Available	Not Available
	Functional (Yes/No)	NA	NA	NA	NA	NA
	Date of testing	NA	NA	NA	NA	NA
iv	PLCC/ Protection coupler (Make and Model)	NA	NA	NA	NA	NA
	Functional (Yes/No)	NA	NA	NA	NA	NA
v	DR (Make &Model) (Make and Model)	NA	NA	NA	NA	NA
	Functional (Yes/No)	NA	NA	NA	NA	NA
vi	Time Synch.Unit (Make and Model)	SANDS GPS	SANDS GPS	SANDS GPS	SANDS GPS	SANDS GPS
	Functional (Yes/No)	NA	NA	NA	NA	NA
<b>Other Protections</b>						
1	Status of Power Swing	Enable	Enable	Enable	Enable	Enable
2	Out of Step	Enable	Enable	Enable	Enable	Enable
3	SOTF	Enable	Enable	Enable	Enable	Enable
4	Breaker Failure	NA	NA	NA	NA	NA
5	Broken Conductor	Alarm	Alarm	Alarm	Alarm	Alarm
6	STUB	NA	NA	NA	NA	NA

Particulars		Tr Line 1	Tr Line 2	Tr Line 3	Tr Line 4	Tr Line 5
7	Fault Locator	Enable	Enable	Enable	Enable	Enable
8	Disturbance Recorder	Enable	Enable	Enable	Enable	Enable
9	VT fuse fail	Alarm	Alarm	Alarm	Alarm	Alarm
10	Overvoltage Protection	NA	NA	NA	NA	NA
11	Trip Circuit supervision	Stand-alone relay	Stand-alone relay	Stand-alone relay	Stand-alone relay	Stand-alone relay
12	Auto-reclose	NA	NA	NA	NA	NA
13	Load encroachment	NA	NA	NA	NA	NA

## Bus-Bar Protection

220kV

Sl. No.	Particulars	Observations
a	Busbar and redundant relay make and model	220 KV Bus Bar Electrostatic Asea make Very old & not working condition
b	Type of Busbar arrangement	NA
c	Zones	NA
d	Dedicated CT core for each busbar protection	NA
e	Breaker Failure relay included, if additional then furnish make and model	NA
f	Trip issued to both Busbar protection in case of enabling	NA
g	Isolator indication and check relays	NA
h	Other requirements for protection checking and validation	NA

132KV: NA

## AC Auxiliary System

Sl. No.	Particulars	Observations
a	Source of AC auxiliary system	01 number 630 KVA (33/0.4KV) & 01 number 250 KVA (33/0.4 KV)
b	Supply changeover between sources (Auto/Manual)	Manual
c	Diesel generator (DG) details	NA
d	Maintenance plan and supply changeover periodicity in DG	NA
e	Single Line Diagram	Copy attached
f	Other requirements for protection checking and validation	NA

## DC Auxiliary System

Sl. No.	Particulars	Observations			
		110 V DC - I	110 V DC - II	48 V DC-I	48 V DC-II
a	<b>Make</b>	Exide VRLA	HBL Lead acid	Exide Led acid	Amarraja VRLA
b	<b>Model/Rating</b>	OPZS 500 AH	300 Ah	300 Ah	300 Ah
c	<b>Vintage</b>	NA	NA	NA	NA
d	<b>Measured voltage</b>				
	<b>i. Positive to Earth</b>	+60V	+60V	NA	NA
	<b>ii. Negative to Earth</b>	-60V	-60V	48V	48V
e	<b>No. of Cells Per Bank</b>	55 Cell	55 Cell	24 Cell	24 Cell
f	<b>Availability of Battery Charger</b>	Mahamai Eng.	Mahamai Eng.	Uptron Power	JSK Power



## Circuit Breakers

Sl. No.	Particulars	Make and Model	No. of trip/close coil	Trip Coil Supervision relay and healthiness of coils	LBB Setting Stage 1	LBB Setting Stage 2	Remarks (If any)
<b>A</b>	<b>220kV System</b>						
1	C.B. 81 SIDCUL	CGL 200-SFM-40AA	02/01	Healthy	NA	NA	NA
2	C.B. 82 Chamba	CGL 200-SFM-40S	02/01	Healthy	NA	NA	NA
3	C.B. 83 IIP	CGL 200-SFM-50AA	02/01	Healthy	NA	NA	NA
4	CB 86 Dharashu-I	CGL 200-SFM-40S	02/01	Healthy	NA	NA	NA
5	CB 87 Dharashu II	CGL 200-SFM-40S	02/01	Healthy	NA	NA	NA
6	CB 85 Buscoupler	CGL 200-SFM-40S	02/01	Healthy	NA	NA	NA
7	CB 881 160 MVA T/F-1	CGL 200-SFM-40S	02/01	Healthy	NA	NA	NA
8	C.B. 884 160 MVA T/F-II	CGL 200-SFM-40S	02/01	Healthy	NA	NA	NA
<b>B</b>	<b>132kV System</b>						
1	C.B. 71 132KV Rksh-Laltapper	ABB LTB145	02/01	Healthy	NA	NA	NA
2	C.B. 72 132KV Rksh-Bindal	CGL 120 SFM-32B	02/01	Healthy	NA	NA	NA
3	C.B. 73 132KV Rksh-Jwalapur	CGL 120 SFM-32B	02/01	Healthy	NA	NA	NA
4	C.B. 76 132KV Rksh-Bhopatwala	CGL 120 SFM-32B	02/01	Healthy	NA	NA	NA
5	C.B. 77 132 KV Rksh-Srinagar	ABB LTB	02/01	Healthy	NA	NA	NA
6	C.B. 75 132 KV Bus-Coupler	CGL 120 SFM-32B	02/01	Healthy	NA	NA	NA

<b>Sl. No.</b>	<b>Particulars</b>	<b>Make and Model</b>	<b>No. of trip/close coil</b>	<b>Trip Coil Supervision relay and healthiness of coils</b>	<b>LBB Setting Stage 1</b>	<b>LBB Setting Stage 2</b>	<b>Remarks (If any)</b>
<b>7</b>	C.B. 781 132KV 160 MVA T/F-I	NA	02/01	Healthy	NA	NA	NA
<b>8</b>	C.B. 782 132KV 40MVA T/F-1	CGL	02/01	Healthy	NA	NA	NA
<b>9</b>	C.B. 783 132 KV 40MVA T/F-2	CGL	02/01	Healthy	NA	NA	NA
<b>10</b>	CB784 132KV 160 MVA T/F-II	NA	02/01	Healthy	NA	NA	NA

## Current Transformer

<b>a</b>	<b>Location of CT</b>	<b>220 KV SIDCUL C.B. 81</b>				
<b>b</b>	Date of CT ratio Test Testing					
		Core I	Core II	Core III	Core IV	Core V
<b>c</b>	Accuracy Class	PS	PS	PS	PS	0.2
<b>d</b>	Purpose	Main I Prot.	Main II Prot.	Bus Bar	Bus Bar	Metering
<b>e</b>	Test Results					
<b>i</b>	Ratio Adopted	800/1	800/1	1600/800/1	1600/800/1	800/1
<b>ii</b>	Ratio measured	NA	NA	NA	NA	NA

<b>a</b>	<b>Location of CT</b>	<b>220 KV Chamba C.B. 82</b>				
<b>b</b>	Date of CT ratio Test Testing					
		Core I	Core II	Core III	Core IV	Core V
<b>c</b>	Accuracy Class	PS	PS	0.2	PS	PS
<b>d</b>	Purpose	Main I Prot.	Main II Prot.	Metering	Bus bar	Bus Bar
<b>e</b>	Test Results					
<b>i</b>	Ratio Adopted	800/1	800/1	800/1	1600/800/1	1600/800/1
<b>ii</b>	Ratio measured	NA	NA	NA	NA	NA

<b>a</b>	<b>Location of CT</b>	<b>220 KV IIP C.B. 83</b>				
<b>b</b>	Date of CT ratio Test Testing					
		Core I	Core II	Core III	Core IV	Core V
<b>c</b>	Accuracy Class	PS	PS	0.2	PS	PS
<b>d</b>	Purpose	Main I Prot.	Main II Prot.	Metering	Bus bar	Bus Bar
<b>e</b>	Test Results					
<b>i</b>	Ratio Adopted	800/1	800/1	800/1	1600/800/1	1600/800/1
<b>ii</b>	Ratio measured	NA	NA	NA	NA	NA

<b>a</b>	<b>Location of CT</b>	<b>220 KV Dharashu I C.B. 86</b>				
<b>b</b>	Date of CT ratio Test Testing					
		Core I	Core II	Core III	Core IV	Core V
<b>c</b>	Accuracy Class	PS	PS	0.2	PS	PS
<b>d</b>	Purpose	Main I Prot.	Main II Prot.	Metering	Bus bar	Bus Bar
<b>e</b>	Test Results					
<b>i</b>	Ratio Adopted	800/1	800/1	800/1	1600/800/1	1600/800/1
<b>ii</b>	Ratio measured	NA	NA	NA	NA	NA

<b>a</b>	<b>Location of CT</b>	<b>220 KV Dharashu II C.B. 87</b>				
<b>b</b>	Date of CT ratio Test Testing					
		Core I	Core II	Core III	Core IV	Core V
<b>c</b>	Accuracy Class	PS	PS	0.2	PS	PS
<b>d</b>	Purpose	Main I Prot.	Main II Prot.	Metering	Bus bar	Bus Bar
<b>e</b>	Test Results					
<b>i</b>	Ratio Adopted	800/1	800/1	800/1	1600/800/1	1600/800/1
<b>ii</b>	Ratio measured	NA	NA	NA	NA	NA

<b>a</b>	<b>Location of CT</b>	<b>220 KV CB 881 (160 MVA T/F-1)</b>				
<b>b</b>	Date of CT ratio Test Testing					
		Core I	Core II	Core III	Core IV	Core V
<b>c</b>	Accuracy Class	PS	PS	PS	PS	0.5
<b>d</b>	Purpose	Main I Prot.	Main II Prot.	Bus bar	Bus Bar	Metering
<b>e</b>	Test Results					
<b>i</b>	Ratio Adopted	500/1	500/1	1600/800/1	1600/800/1	500/1
<b>ii</b>	Ratio measured	NA	NA	NA	NA	NA

<b>a</b>	<b>Location of CT</b>	<b>220 KV CB 884 (160 MVA T/F-2)</b>				
<b>b</b>	Date of CT ratio Test Testing					
		Core I	Core II	Core III	Core IV	Core V
<b>c</b>	Accuracy Class	PS	PS	PS	PS	0.5
<b>d</b>	Purpose	Main I Prot.	Main II Prot.	Bus bar	Bus Bar	Metering
<b>e</b>	Test Results					
<b>i</b>	Ratio Adopted	500/1	500/1	1600/800/1	1600/800/1	500/1
<b>ii</b>	Ratio measured	NA	NA	NA	NA	NA

<b>a</b>	<b>Location of CT</b>	<b>132 KV C.B. 71 Rishikesh-Majra</b>				
<b>b</b>	Date of CT ratio Test Testing					
		Core I	Core II	Core III	Core IV	Core V
<b>c</b>	Accuracy Class	PS	PS	0.2	PS	PS
<b>d</b>	Purpose	Main I Prot.	Main II Prot.	Metering	Not used	Not used
<b>e</b>	Test Results					
<b>i</b>	Ratio Adopted	400/1	400/1	400/1	400/1	400/1
<b>ii</b>	Ratio measured	NA	NA	NA	NA	NA

<b>a</b>	<b>Location of CT</b>	<b>132 KV C.B. 72 Rishikesh-Bindal</b>				
<b>b</b>	Date of CT ratio Test Testing					
		Core I	Core II	Core III	Core IV	Core V
<b>c</b>	Accuracy Class	PS	PS	0.2	PS	PS
<b>d</b>	Purpose	Main I Prot.	Main II Prot.	Metering	Not used	Not used
<b>e</b>	Test Results					
<b>i</b>	Ratio Adopted	400/1	400/1	400/1	400/1	400/1
<b>ii</b>	Ratio measured	NA	NA	NA	NA	NA

<b>a</b>	<b>Location of CT</b>	<b>132 KV C.B. 73 Rishikesh-Jwalapur</b>				
<b>b</b>	Date of CT ratio Test Testing					
		Core I	Core II	Core III	Core IV	Core V
<b>c</b>	Accuracy Class	PS	PS	0.2	PS	PS
<b>d</b>	Purpose	Main I Prot.	Main II Prot.	Metering	Not used	Not used
<b>e</b>	Test Results					
<b>i</b>	Ratio Adopted	800/1	800/1	400/1	1600/800/1	1600/800/1
<b>ii</b>	Ratio measured	NA	NA	NA	NA	NA

<b>a</b>	<b>Location of CT</b>	<b>132 KV C.B. 76 Rishikesh-Bhopatwala</b>				
<b>b</b>	Date of CT ratio Test Testing					
		Core I	Core II	Core III	Core IV	Core V
<b>c</b>	Accuracy Class	PS	PS	0.2	PS	PS
<b>d</b>	Purpose	Main I Prot.	Main II Prot.	Metering	Not used	Not used
<b>e</b>	Test Results					
<b>i</b>	Ratio Adopted	800/1	800/1	400/1	1600/800/1	1600/800/1
<b>ii</b>	Ratio measured	NA	NA	NA	NA	NA

<b>a</b>	<b>Location of CT</b>	<b>132 KV C.B. 77 Rishikesh-Srinagar</b>				
<b>b</b>	Date of CT ratio Test Testing					
		Core I	Core II	Core III	Core IV	Core V
<b>c</b>	Accuracy Class	PS	PS	0.2	PS	PS
<b>d</b>	Purpose	Main I Prot.	Main II Prot.	Metering	Not used	Not used
<b>e</b>	Test Results					
<b>i</b>	Ratio Adopted	400/1	400/1	400/1	400/1	400/1
<b>ii</b>	Ratio measured	NA	NA	NA	NA	NA



<b>a</b>	<b>Location of CT</b>	<b>CB 781 160 MVA T/F-1 L.V.</b>				
<b>b</b>	Date of CT ratio Test Testing					
		Core I	Core II	Core III	Core IV	Core V
<b>c</b>	Accuracy Class	PS	PS	0.2	PS	PS
<b>d</b>	Purpose	Main I Prot.	O/C & E/F	Metering	Not used	Not used
<b>e</b>	Test Results					
<b>i</b>	Ratio Adopted	800/1	800/1	800/1	800/1	800/1
<b>ii</b>	Ratio measured	NA	NA	NA	NA	NA

<b>a</b>	<b>Location of CT</b>	<b>C.B. 784 160 MVA T/F-II L.V.</b>				
<b>b</b>	Date of CT ratio Test Testing					
		Core I	Core II	Core III	Core IV	Core V
<b>c</b>	Accuracy Class	PS	PS	0.2	PS	PS
<b>d</b>	Purpose	Main I Prot.	O/C & E/F	Metering	Not used	Not used
<b>e</b>	Test Results					
<b>i</b>	Ratio Adopted	800/1	800/1	800/1	800/1	800/1
<b>ii</b>	Ratio measured	NA	NA	NA	NA	NA

<b>a</b>	<b>Location of CT</b>	<b>C.B. 782 40 MVA T/F-I</b>				
<b>b</b>	Date of CT ratio Test Testing					
		Core I	Core II	Core III	Core IV	Core V
<b>c</b>	Accuracy Class	PS	PS	0.2	PS	PS
<b>d</b>	Purpose	Main I Prot.	O/C & E/F.	Metering	Not used	Not used
<b>e</b>	Test Results					
<b>i</b>	Ratio Adopted	800/1	800/1	400/1	1600/800/1	1600/800/1
<b>ii</b>	Ratio measured	NA	NA	NA	NA	NA

<b>a</b>	<b>Location of CT</b>	<b>C.B. 783 40 MVA T/F-II</b>				
<b>b</b>	Date of CT ratio Test Testing					
		Core I	Core II	Core III	Core IV	Core V
<b>c</b>	Accuracy Class	PS	PS	0.2	PS	PS
<b>d</b>	Purpose	Main I Prot.	O/C & E/F	Metering	Not used	Not used
<b>e</b>	Test Results					
<b>i</b>	Ratio Adopted	800/1	800/1	400/1	1600/800/1	1600/800/1

## Capacitive Voltage Transformer/Potential Transformer

<b>a</b>	<b>Location of CVT/PT</b>	<b>C.B. 81</b>		
<b>b</b>	Date of CT/PT ratio Test Testing			
		Core I	Core II	Core III
<b>c</b>	Accuracy Class	PS	PS	0.2
<b>d</b>	Purpose	Main I	Main II	Metering
<b>e</b>	Test Results			
<b>i</b>	Ratio Adopted	220 KV/110 V	220 KV/110 V	220 KV/110 V
<b>ii</b>	Ratio measured	NA	NA	NA

<b>a</b>	<b>Location of CVT/PT</b>	<b>C.B. 82</b>		
<b>b</b>	Date of CT/PT ratio Test Testing			
		Core I	Core II	Core III
<b>c</b>	Accuracy Class	PS	PS	0.2
<b>d</b>	Purpose	Main I	Main II	Metering
<b>e</b>	Test Results			
<b>I</b>	Ratio Adopted	220 KV/110 V	220 KV/110 V	220 KV/110 V
<b>ii</b>	Ratio measured	NA	NA	NA

<b>a</b>	<b>Location of CVT/PT</b>	<b>C.B. 83</b>		
<b>b</b>	Date of CT/PT ratio Test Testing			
		Core I	Core II	Core III
<b>c</b>	Accuracy Class	PS	PS	0.2
<b>d</b>	Purpose	Main I	Main II	Metering
<b>e</b>	Test Results			
<b>i</b>	Ratio Adopted	220 KV/110 V	220 KV/110 V	220 KV/110 V
<b>ii</b>	Ratio measured	NA	NA	NA

<b>a</b>	<b>Location of CVT/PT</b>	<b>C.B. 86</b>		
<b>b</b>	Date of CT/PT ratio Test Testing			
		Core I	Core II	Core III
<b>c</b>	Accuracy Class	PS	PS	0.2
<b>d</b>	Purpose	Main I	Main II	Metering
<b>e</b>	Test Results			
<b>i</b>	Ratio Adopted	220 KV/110 V	220 KV/110 V	220 KV/110 V
<b>ii</b>	Ratio measured	NA	NA	NA

<b>a</b>	<b>Location of CVT/PT</b>	<b>C.B. 87</b>		
<b>b</b>	Date of CT/PT ratio Test Testing			
		Core I	Core II	Core III
<b>c</b>	Accuracy Class	PS	PS	0.2
<b>d</b>	Purpose	Main I	Main II	Metering
<b>e</b>	Test Results			
<b>i</b>	Ratio Adopted	220 KV/110 V	220 KV/110 V	220 KV/110 V
<b>ii</b>	Ratio measured	NA	NA	NA

<b>a</b>	<b>Location of CVT/PT</b>	<b>220 KV Bus I CVT</b>		
<b>b</b>	Date of CT/PT ratio Test Testing			
		Core I	Core II	Core III
<b>c</b>	Accuracy Class	PS	PS	0.2
<b>d</b>	Purpose	NA	NA	Metering
<b>e</b>	Test Results			
<b>i</b>	Ratio Adopted	220 KV/110 V	220 KV/110 V	220 KV/110 V
<b>ii</b>	Ratio measured	NA	NA	NA

<b>a</b>	<b>Location of CVT/PT</b>	<b>220 KV Bus II CVT</b>		
<b>b</b>	Date of CT/PT ratio Test Testing			
		Core I	Core II	Core III
<b>c</b>	Accuracy Class	PS	PS	0.2
<b>d</b>	Purpose	NA	NA	Metering
<b>e</b>	Test Results			
<b>i</b>	Ratio Adopted	220 KV/110 V	220 KV/110 V	220 KV/110 V
<b>ii</b>	Ratio measured	NA	NA	NA

<b>a</b>	<b>Location of CVT/PT</b>	<b>C.B. 71 Rishikesh-Laltapper</b>		
<b>b</b>	Date of CT/PT ratio Test Testing			
		Core I	Core II	Core III
<b>c</b>	Accuracy Class	PS	PS	0.2
<b>d</b>	Purpose	Main I	O/C &E/F	Metering
<b>e</b>	Test Results			
<b>i</b>	Ratio Adopted	132 KV/110 V	132 KV/110 V	132 KV/110 V
<b>ii</b>	Ratio measured	NA	NA	NA

<b>a</b>	<b>Location of CVT/PT</b>	<b>C.B. 72 Rishikesh-Bindal</b>		
<b>b</b>	Date of CT/PT ratio Test Testing			
		Core I	Core II	Core III
<b>c</b>	Accuracy Class	PS	PS	0.2
<b>d</b>	Purpose	Main I	O/C &E/F	Metering
<b>e</b>	Test Results			
<b>i</b>	Ratio Adopted	132 KV/110 V	132 KV/110 V	132 KV/110 V
<b>ii</b>	Ratio measured	NA	NA	NA

<b>a</b>	<b>Location of CVT/PT</b>	<b>C.B. 73 Rishikesh-Jwalapur</b>		
<b>b</b>	Date of CT/PT ratio Test Testing			
		Core I	Core II	Core III
<b>c</b>	Accuracy Class	PS	PS	0.2
<b>d</b>	Purpose	Main I	O/C &E/F	Metering
<b>e</b>	Test Results			
<b>i</b>	Ratio Adopted	132 KV/110 V	132 KV/110 V	132 KV/110 V
<b>ii</b>	Ratio measured	NA	NA	NA

<b>a</b>	<b>Location of CVT/PT</b>	<b>C.B. 76 Rishikesh-Bhopatwala</b>		
<b>b</b>	Date of CT/PT ratio Test Testing			
		Core I	Core II	Core III
<b>c</b>	Accuracy Class	PS	PS	0.2
<b>d</b>	Purpose	Main I	O/C &E/F	Metering
<b>e</b>	Test Results			
<b>i</b>	Ratio Adopted	132 KV/110 V	132 KV/110 V	132 KV/110 V
<b>ii</b>	Ratio measured	NA	NA	NA

<b>a</b>	<b>Location of CVT/PT</b>	<b>C.B. 77 Rishikesh-Srinagar</b>		
<b>b</b>	Date of CT/PT ratio Test Testing			
		Core I	Core II	Core III
<b>c</b>	Accuracy Class	PS	PS	0.2
<b>d</b>	Purpose	Main I	O/C &E/F	Metering
<b>e</b>	Test Results			
<b>i</b>	Ratio Adopted	132 KV/110 V	132 KV/110 V	132 KV/110 V
<b>ii</b>	Ratio measured	NA	NA	NA



<b>a</b>	<b>Location of CVT/PT</b>	<b>132 KV Bus CVT</b>		
<b>b</b>	Date of CT/PT ratio Test Testing			
		Core I	Core II	Core III
<b>c</b>	Accuracy Class	PS	PS	0.2
<b>d</b>	Purpose	NA	NA	Metering
<b>e</b>	Test Results			
<b>i</b>	Ratio Adopted	132 KV/110 V	132 KV/110 V	132 KV/110 V
<b>ii</b>	Ratio measured	NA	NA	NA

## Transformer Protection

Particulars	TF-1	TF-2	TF-3	TF-4
<b>Name of ICT</b>	160 MVA 220/132KV	160 MVA 220/132KV	40 MVA 132/33KV	40 MVA 132/33 KV
<b>Make</b>	BHEL	CGL	ALSTOM	EMCO
<b>Connected to dedicated CT core (HV Bay)</b>				
<b>Core-1</b>	Diff. Prot.	Diff. Prot.	Diff. Prot.	Diff. Prot.
<b>Core-2</b>	O/C &E/F	O/C &E/F	O/C &E/F	O/C &E/F
<b>Core-3</b>	Bus bar	Bus bar	Metering	Metering
<b>Core-4</b>	Bus bar	Bus bar	Not used	Not used
<b>Core-5</b>	Metering	Metering	Not used	Not used
<b>CT ratio</b>	500/800/1	500/800/1	1600/800/1 800/400/1 Met	1600/800/1 800/400/1 Met
<b>Connected to dedicated Bus CVT core (HV Bay)</b>				
<b>Core-1</b>	PS	PS	PS	PS
<b>Core-2</b>	PS	PS	PS	PS
<b>Core-3</b>	0.2	0.2	0.2	0.2
<b>CVT ratio</b>	220KV/110V	220KV/110V	132KV/110V	132KV/110V
<b>Relay connected to Trip Coil-1 or 2 or both (HV)</b>	Both	Both	Both	Both

Particulars	TF-1	TF-2	TF-3	TF-4
<b>Feed from DC supply-1 or 2(LV)</b>	Both	Both	Both	Both
<b>Connected to dedicated CT core (LV Bay)</b>				
<b>Core-1</b>	Diff. Prot.	Diff. Prot.	Diff. Prot.	Diff. Prot.
<b>Core-2</b>	O/C & E/F	O/C & E/F	O/C & E/F	O/C & E/F
<b>Core-3</b>	Metering	Metering	Metering	Metering
<b>Core-4</b>	Bus Bar	Bus Bar	Not used	Not used
<b>Core-5</b>	Bus Bar	Bus Bar	Not used	Not used
<b>CT ratio</b>	1600/800/1	1600/800/1	1600/800/1	1600/800/1
<b>Connected to dedicated Bus CVT core (LV Bay)</b>				
<b>Core-1</b>	PS	PS	PS	PS
<b>Core-2</b>	PS	PS	PS	PS
<b>Core-3</b>	0.2	0.2	0.2	0.2
<b>CVT ratio</b>	220KV/110V	220KV/110V	132KV/110V	132KV/110V
<b>Relay connected to Trip Coil-1 or 2 or both (HV)</b>	Both	Both	Both	Both
<b>Feed from DC supply-1 or 2(LV)</b>	Both	Both	Both	Both
<b>LA Rating/ HV Side</b>	NA	NA	NA	NA
<b>LA Rating/ LV Side</b>	NA	NA	NA	NA

Particulars		TF-1	TF-2	TF-3	TF-4
<b>Date of last testing of Protection</b>		02-11-2023	27-10-2023	02-11-2023	02-11-2023
<b>Group A Protection</b>					
1	Differential Protection (Make & Model)	Micom P633	Gee Multilin T-60	Schneider P643	Schneider P643
2	PRV	OK	OK	OK	OK
3	WTI Indication working	OK	OK	OK	OK
4	Back-up Over Current Protection HV (Make & Model)	Micom P141	Schneider P143	Schneider P143	Schneider P143
5	Over Flux Protection (Make & Model) HV	Feature used in Differential Relay	Feature used in Differential Relay	Feature used in Differential Relay	Feature used in Differential Relay
<b>Group B Protection</b>					
1	REF Protection (Make & Model)	E.E. CAG14AF12A	E.E. CAG14AF12A	NA	NA
2	Bucholtz	OK	OK	OK	OK
3	Back-up Over Current Protection LV (Make & Model)	Micom P141	Schneider P143	Schneider P143	Schneider P143
4	Over Flux Protection (Make & Model) LV	NA	NA	NA	NA
5	OTI Indication working	Ok	Ok	Ok	Ok

# Network Diagram of Uttarakhand

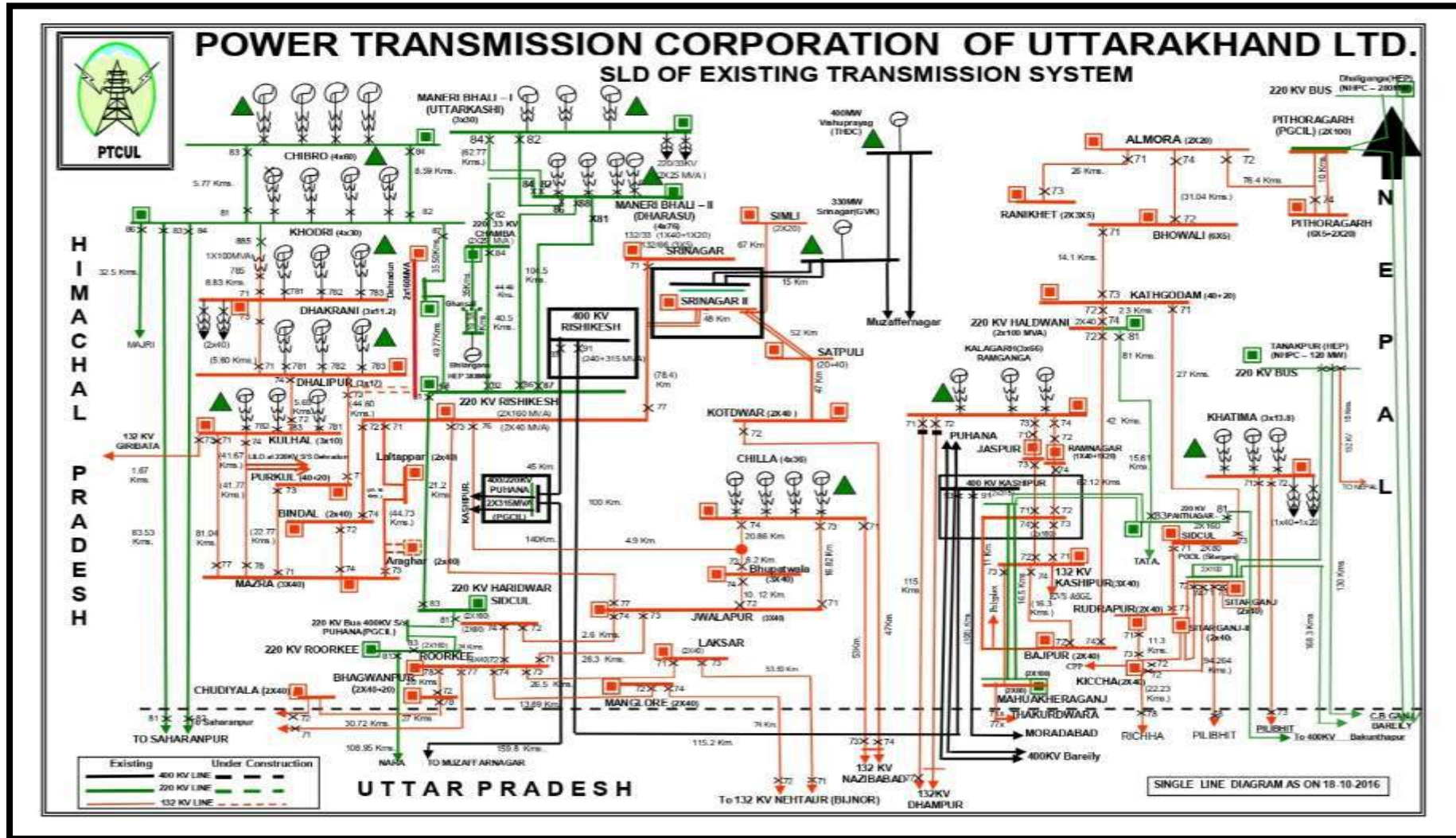

## Power Map of Uttarakhand

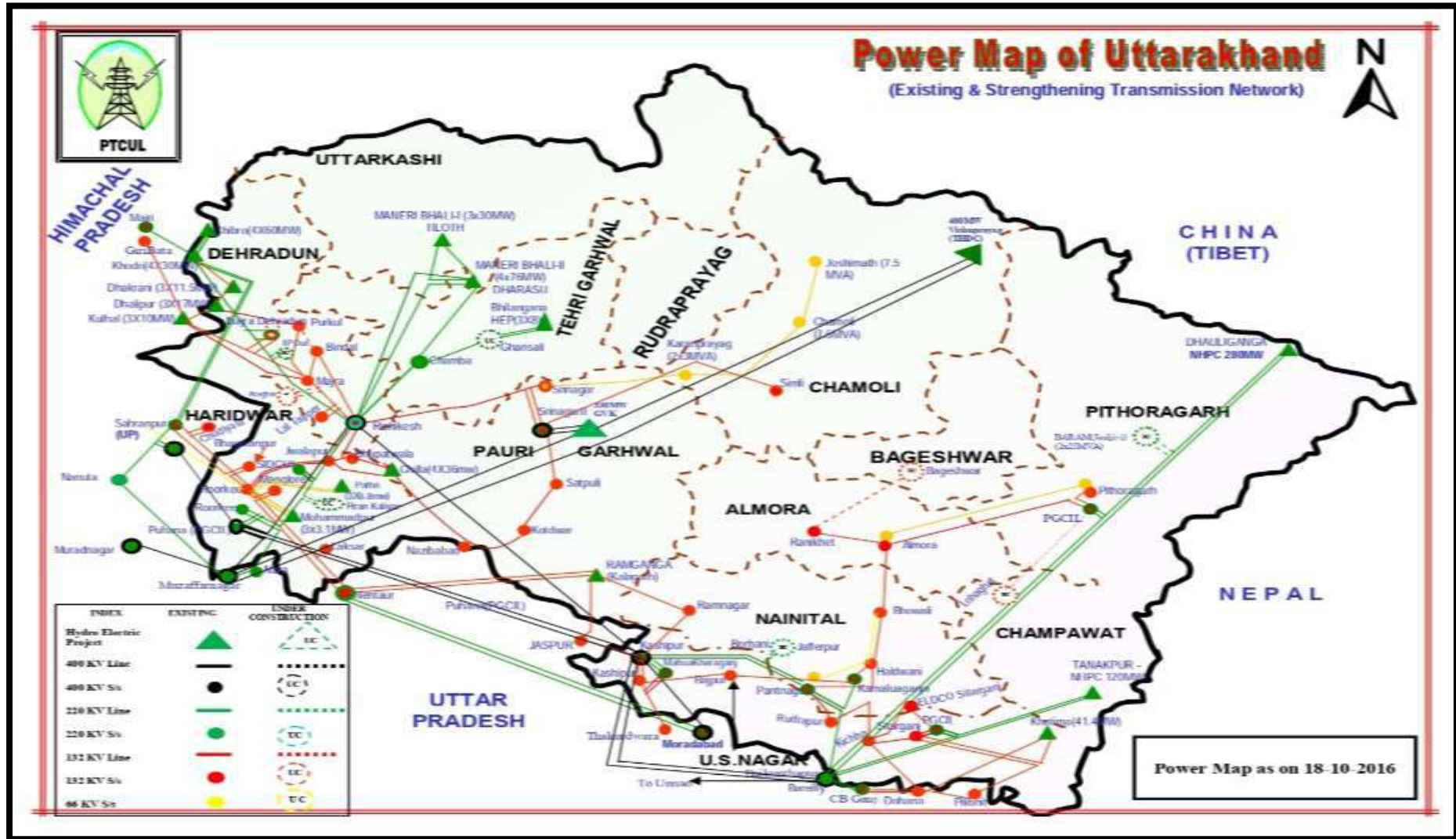





# **Power Transmission Corporation of Uttarakhand Limited**

(A Govt. of Uttarakhand Undertaking)

Corporate ID No.: U40101UR2004SGC028675

## **FINAL REPORT**

### **Protection Audit**

#### **220/33KV Chamba Substation**

**Submitted**

**By**



**CENTRAL BOARD OF IRRIGATION & POWER**

**NEW DELHI**



# केन्द्रीय सिंचाई व शक्ति मंडल CENTRAL BOARD OF IRRIGATION AND POWER

25<sup>th</sup> June 2024

Order No.: 376/SE (T&C)/PTCUL/(H). dated: 29.09.2023

## Protection Audit Report

FINAL PROTECTION AUDIT REPORT OF 220/33 KV CHAMBA SUBSTATION UNDER POWER TRANSMISSION CORPORATION OF UTTARAKHAND LIMITED (PTCUL), UTTARAKHAND.

Submitted  
To



**Power Transmission Corporation of Uttarakhand Limited**

(A Govt. of Uttarakhand Undertaking)

Corporate ID No.: U40101UR2004SGC028675



# Contents

<b>Disclaimer</b> .....	6
<b>1.0. Executive Summary</b> .....	7
<b>2.0. Introduction</b> .....	10
2.1. <i>Background</i> .....	10
2.2. <i>Scope of Work</i> .....	10
2.3. <i>Audit Rationale</i> .....	11
2.4. <i>Audit Process</i> .....	12
2.5. <i>About Power Transmission Corporation of Uttarakhand (PTCUL)</i> .....	14
2.6. <i>About Central Board of Irrigation &amp; Power (CBIP)</i> .....	15
<b>3.0. Preliminary Audit of 220/33 kV Chamba Substation</b> .....	16
3.1. <i>General Information about Sub-station</i> .....	16
3.2. <i>Audit Team</i> .....	16
3.3. <i>Recommendation of last protection checking and validation</i> .....	17
3.4. <i>Review of existing settings at substation</i> .....	17
3.5. <i>Disturbance Recorder availability for the last 6 tripping's</i> .....	17
3.6. <i>Chronic reason of tripping, if any</i> .....	17
3.7. <i>Major non-conformity/deficiency observed</i> .....	18
<b>4.0. List of Trippings</b> .....	19
<b>5.0. Observations and Recommendations</b> .....	26
5.1. <i>Reporting of all the Tripping with DR/EL</i> .....	26
5.2. <i>Development of centralized database of relay settings</i> .....	26
5.3. <i>Review of test results of relay and equipment</i> .....	27
5.4. <i>Availability of Testing Kits</i> .....	27
5.5. <i>Up-dation of PTCUL Protection Philosophy</i> .....	27
5.6. <i>Simulation based study of protection system</i> .....	28
5.7. <i>Capacity Building of protection team</i> .....	28
5.8. <i>Updated Fault Level/ Short Circuit Level and Network information</i> .....	28
5.9. <i>General Protection related observations</i> .....	28
5.10. <i>O&amp;M Manual</i> .....	28
<b>6.0. Station Specific Observation and Recommendations</b> .....	29
6.1. <i>Protection related observations and recommendations</i> .....	29
6.2. <i>Equipment related observations and recommendations</i> .....	29
6.3. <i>Auxiliary Equipment related observations and recommendations</i> .....	30
<b>Annexure – 1: Suggested List of Testing Instruments</b> .....	31
<b>Annexure – 2: Suggested List of Substation Equipments</b> .....	32

**Annexure – 3: Suggested List of Maintenance Equipments.....33**  
**Annexure – 4: Protection Code (IEGC 2023 Chapter 4).....34**  
**Annexure – 5: Third Party Protection System Checking & Validation Template for a  
Substation (IEGC 2023 Annexure – 1).....39**  
**Annexure – 6: Protection Philosophy/Protocol of Northern Region .....44**  
**Annexure – 7: Work Order & Corrigendum.....50**  
**Annexure – 8: Data Sheets .....58**

## ACRONYMS

<b>A</b>	Ampere
<b>AC</b>	Alternating Current
<b>AMP</b>	Annual Maintenance Plan
<b>CBIP</b>	Central Board of Irrigation and Power
<b>CT</b>	Current Transformer
<b>CVT</b>	Capacitive Voltage Transformer
<b>DC</b>	Direct Current
<b>DG</b>	Diesel Generator
<b>DPR</b>	Detailed Project Report
<b>DR</b>	Disturbance Recorder
<b>EL</b>	Event Logger
<b>EMTP</b>	Electromagnetic Transient Program
<b>GPS</b>	Global Positioning System
<b>ICT</b>	Inter Connecting Transformer
<b>IEGC</b>	Indian Electricity Grid Code
<b>KA</b>	Kilo Ampere
<b>KV</b>	Kilo Volt
<b>LBB</b>	Local Breaker Backup
<b>LEFT</b>	Earth Fault
<b>MVA</b>	Mega Volt Ampere
<b>NA</b>	Not Available
<b>NRPC</b>	Northern Regional Power Committee
<b>O&amp;M</b>	Operation & Maintenance
<b>OCC</b>	Operation Coordination Sub Committee
<b>PLCC</b>	Power Line Carrier Communication
<b>PSC</b>	Power System Sub Committee
<b>PSDF</b>	Power System Development Fund
<b>PT</b>	Potential Transformer
<b>PTCUL</b>	Power Transmission Corporation of Uttarakhand Limited.
<b>RLDC</b>	Regional Load Dispatch Centre
<b>RPC</b>	Regional Power Committee
<b>SAS</b>	Substation Automation System

<b>SLD</b>	Single Line Diagram
<b>SLDC</b>	State Load Dispatch Centre
<b>SOTF</b>	Switch On-To Fault
<b>SPS</b>	Special Protection Scheme
<b>UJVNL</b>	Uttarakhand Jal Vidyut Nigam Ltd
<b>UPCL</b>	Uttarakhand Power Corporation Ltd
<b>WTI</b>	Winding Temperature Indicator

## Disclaimer

The protection audit has been carried out based on the guidelines provided under various documents mentioned in the report. For the purpose of audit, the auditor(s) have relied upon the data made available by the client and information & clarifications made available, in the written or verbal form, by the officials of clients during site visit and later.

The report is not for public distribution and has been furnished solely for information and must not be reproduced or redistributed to others, except those concerned. No one can use the report as a base for any claim, demand or cause of action and, also no one is responsible for any loss incurred based upon the content of this report.

While every effort is made to ensure the accuracy and completeness of information contained, CBIP takes no responsibility and assumes no liability for any error/ omission or accuracy of the information. Recipients of this material should rely on their own judgments and conclusions from relevant sources before taking any decision.

## 1.0. Executive Summary

PTCUL awarded the work of Third-Party Protection Audit of 2 nos. 400kV and 8 nos. 220kV substations of PTCUL (“Utility”) to CBIP. CBIP planned the audit as per Audit process provided under Protection Code within Indian Electricity Grid Code 2023. In addition, the guidelines of Ramakrishna Committee for checking and validation and NRPC guidelines for Third Party Audit were also adhered too. The CBIP manual on protection (manual no 247-Revised), NRPC protection philosophy were also referred too.

As a part of audit process, utility was asked to provide set of information before start of audit. Team from CBIP consisting of Mr. Vijay Barthwal, Mr. M.R. Chauhan, Mr. Shivam Gupta & Mr. Avichal Pandey visited 220/33KV Chamba Substation during 20<sup>th</sup> – 21<sup>st</sup> February 2024 and preliminary audit report was submitted on the spot. The representatives of utility were present during this process. Some more information was sought from the Utility.

Based on the data made available by Utility, draft of final report was submitted to Utility and after discussions, report was finalized. The details of audit process, data made available by Utility, observations from preliminary report and detailed observations and recommendations are provided in this report. Key observations and recommendations are summarized below.

### **General Observations and Recommendations for Organization Level implementation**

01. It is recommended that each substation to have a central repository for tripping reports, along with Time Synchronized DR/EL reports and analysis. A dedicated PC can be provided at each substation for the purpose.
02. The protection philosophy adopted by Utility, in general, is in alignment with protection philosophy adopted by NRPC. As the NRPC has recently updated the protection philosophy, PTCUL in consultation with SLDC may update protection philosophy for network not covered by NRPC too, if needed, and implement the same.
03. It is recommended that latest recommended relay settings, as per the NRPC protocol for 220KV & above Substations, along with setting calculations & parameters used for all the relays, be kept at each substation. This will help in proper fault analysis and ascertaining relay healthiness. Similarly, Relay settings for sub-stations below 220KV, based on any such protocol by SLDC, along with setting calculations and line parameters also needs to be maintained.
04. It is recommended that the detailed reports of test results for the relays and switchyard equipments be maintained at sub-station level.

05. Based on “Draft O&M Manual” of PTCUL and discussions with their officials, a list of testing equipment is suggested and enclosed at Point 5.4. It is recommended that the necessary testing equipment at substation/Sub-division/Division be arranged for regular testing of equipment at substations.
06. Simulation based studies or EMTP Studies should be carried out by the Utility, as per the requirement of IEGC.
07. For the protection system and SAS, PTCUL may undertake capacity building exercise for the officials involved in these activities.
08. It is recommended that the updated network information and short circuit level should be periodically reviewed and maintained at central level for revising the setting as per requirement.
09. It is suggested that utility may carry out exhaustive safety and technical audit of sub-stations apart from protection audit, either internally or thru’ third party for implementing the best practices in the sub-station. In addition, the existing draft O&M manual also be updated to take care of latest developments.

#### **Observations and Recommendations for 220/33KV Chamba Substation**

1. The protection audit of sub-station is carried out for first time.
2. It is suggested that possibility of 220KV Bus-bar protection be examined by PTCUL.
3. The station is directly connected to 24 MW BHP and 304 MW Dhrashu Hydro Plant at 220KV level and distributed solar plant on 33KV side. It is recommended that whenever new solar plant is added on 33KV side of UPCL system, relay settings be co-ordinated with UPCL.
4. Some analogue and digital signal are not appearing in the SAS. It is recommended that SAS system be updated.
5. The slave display clock in the control room be rectified.
6. The SAS GUI time is not synchronised and displays time different from GPS. It is suggested to take necessary remedial measures for the same.
7. The sub-station is very old and availability of land is a constraint. The operation of transformer thru Auxiliary bus and switching thru TBC creates operation and maintenance constraints. It is suggested that PTCUL get the studies carried out for connecting both transformer on separate auxiliary buses and thru TBC for the purpose of reliability and ease of maintenance.
8. Some of the switchyard equipments need replacement due to obsolesce. It is recommended to expedite the same after due testing and study/recommendations.
9. Second station transformer for auxiliary supply is being planned. It is recommended to expedite the installation of 2<sup>nd</sup> auxiliary source.

10. The 110V DC system is designed for single source. 2 nos. of 110V DC systems are provided. IT is suggested that PTCUL examines the possibility of dual source DC supply to protection system.
11. Single 48V DC system is provided and chargers are not operating satisfactorily. It is recommended to take corrective actions in this regard.



## 2.0. Introduction

### 2.1. Background

The work has been awarded to the Central Board of Irrigation & Power (CBIP) vide Work Order Number: 376/SE (T&C)/PTCUL/(H), dated: 29.09.2023 for Protection Audit of 02 Nos. 400 kV and 08 Nos. 220 kV Sub-Stations at Uttarakhand, for Power Transmission Corporation of Uttarakhand Limited (PTCUL) in reference to the offer submitted by CBIP to PTCUL vide ref. no. P-1/CBIP/PTCUL/Audit/2023, dated: 11.09.2023. A Kick-Off Meeting was held between PTCUL and CBIP at the office of SE (T&C), PTCUL, Kathgodam, Haldwani on 26<sup>th</sup> October 2023. Detailed discussions were held regarding process and methodology of Execution and Submission of reports of Protection Audit. As per the above-mentioned meeting, a corrigendum was released by PTCUL vide ref. no. 394/SE (T&C)/PTCUL/(H), dated: 26.10.2023.

**As per the given order, the protection audit of following sub-stations is to be carried out:**

1. *400kV Rishikesh*
2. *400kV Kashipur*
3. *220kV Chamba*
4. *220kV Rishikesh*
5. *220kV Roorkee*
6. *220kV Haridwar (SIDCUL)*
7. *220kV Jhajra*
8. *220kV Pantnagar*
9. *220kV Haldwani*
10. *220kV Mahuakheraganj*

### 2.2. Scope of Work

Review of the implemented protection schemes/philosophy for 400/220 kV substations which includes protection of transmission lines, interconnecting transformers, line/bus reactors, bus bar, bus couplers etc. with respect to tripping in last one year as per latest guidelines of Ramakrishna committee/ CBIP/NRPC/International best practices, which includes review of the following:

- a. *Adequacy of primary and backup protection settings for protected equipment and suggest corrective measures.*
- b. *Availability/healthiness of PLCC communication links used for protection systems.*
- c. *Healthiness/adequacy of 220/110/50V DC system available at substations for protection application.*
- d. *Availability/healthiness of GPS system and time synchronization facility used for protection.*
- e. *Availability/healthiness of recording instruments like DRs /ELs for transmission lines protection.*
- f. *Test reports for assessing the healthiness of circuit breakers, CT & CVT based upon available test reports at sites.*
- g. *Field inspection of protection device for obsolescence of technology, suitability and healthiness.*
- h. *Prepare recommendation for replacement of obsolescence relays with compatible numerical relays will be provided.*
- i. *Checking of availability of DG Set / auxiliary DC supply at substations.*

### **2.3. Audit Rationale**

- a. PTCUL (Utility) has submitted a DPR for Replacement of certain equipments under PSDF scheme to Grid-India. Grid-India has asked PTCUL to carry out protection audit of certain substations.
- b. In addition, as per CERC IEGC 2023 Chapter-04 (Protection Code) Para - 15 (2) “All users shall also conduct third party protection audit of each substation at 220KV and above (132KV and above in NER) once in 5 years or earlier as advised by the respective RPC”.
- c. As per Para – 15 (4) of said Code, “The third-party protection audit report shall contain information sought in the format enclosed as Annexure–1. The protection audit reports, along with action plan for rectification of deficiencies detected, if any, shall be submitted to the respective RPC and RLDC or SLDC, as the case may be, within a month of submission of third-party audit report. The necessary compliance to such protection audit report shall be followed up regularly in the respective RPC”.
- d. Subsequently NRPC issued protection philosophy for Northern region developed in compliance of IEGC 2023, Version 2.0 which was approved in 71<sup>st</sup> NRPC meeting held on 29.01.2024. Accordingly, protection audit of 220KV and above Substations is being carried out by CBIP, as per IEGC-2023 Annexure-1.

## 2.4. *Audit Process*

- PTCUL shall provide the following documents:
  - a. The Network Diagram, covering the relevant assets
  - b. Latest relay settings adopted and calculations for respective sub-stations and transmission lines.
  - c. Annual maintenance plan (AMP), including the schedule and activities covered under AMP
  - d. Any specific issues covered under OCC and/or PSC of NRPC for relevant assets.
- For each sub-station, check-list shall be provided by PTCUL. During field visit, the information shall be verified.
- The minimum set of points on which checking and validation shall be carried out is provided as per annexure - 4 for the following available power system elements at station, as per attached formats:

<b>Sl. No.</b>	<b>Elements</b>
<b>1</b>	Transmission Line
<b>2</b>	Bus Reactor/Line Reactor
<b>3</b>	Inter-connecting Transformer
<b>4</b>	Busbar
<b>5</b>	AC auxiliary system
<b>6</b>	DC auxiliary system
<b>7</b>	Communication system
<b>8</b>	Circuit Breaker Details
<b>9</b>	Current Transformer Details
<b>10</b>	Capacitive Voltage Transformers Details
<b>11</b>	Any other equipment/system relevant for protection system operation

- During field visit, no testing of equipment and relay shall be carried out. The visual inspection, operational log shall be considered for audit purpose, apart from the documents provided by PTCUL.

- A calibrated multi-meter shall be provided at sub-station for checking AC and DC voltages and currents online, wherever feasible, without impacting the sub-station operations.
- The preliminary report shall be prepared on the site and shall be signed by all the parties present, as given below:

S. No.	Issues	Remarks
1	Recommendation of last protection checking and validation	Status of works and pending issues if any
2	Review of existing settings at substation	Recommended Action
3	Disturbance Recorder out/ available for last 6 tripping's (Y/N)	Recommended Action
4	Chronic reason of tripping, if any	Recommended Action
5	Major non-conformity/deficiency observed	Recommended Action

- **The Final summary shall specifically mention minimum following points:**
  - The settings and scheme adopted are in line with agreed protection philosophy or any accepted guidelines (e.g., Ramakrishna guidelines or CBIP manual based).
  - The deviations from the RPC protection philosophy, if any and reasons for taking the deviations shall be recorded.
  - All the major general deficiency shall be listed in detail along with remedial recommendations.
  - The cases of protection maloperation (last 1 year) shall be analysed from tripping reports and the causes of failure along with corrective actions and recommendations based on the findings.

## ***2.5. About Power Transmission Corporation of Uttarakhand (PTCUL)***

The State of Uttarakhand's power transmission utility, PTCUL, was formerly known as Uttaranchal. According to the Uttar Pradesh State Reorganization Act 2000, this 27<sup>th</sup> state of the republic of India was formed on November 9, 2000, by dividing the Himalayan and surrounding North-Western districts of Uttar Pradesh.

The State of Uttaranchal in exercise of the power granted to it under section 63(4) of the State Re-Organization Act, 2000, formed two separate companies in power sector:

- Uttaranchal Jal Vidyut Nigam Ltd. (UJVNL) – For generation of Hydro-Electricity in the State.
- Uttaranchal Power Corporation Ltd. (UPCL) – For Transmission and Distribution of Electricity in the state.

Enactment of the Electricity Act 2003, a distinct watershed in the Indian Power Sector, made it mandatory for all the States to restructure their SEBs. As per the provisions of Electricity Act 2003, the State Government separated power transmission business from UPCL which was left only with distribution of electricity.

In order to manage Power Transmission Operations, a new company called Power Transmission Corporation of Uttaranchal Ltd. was established. On 27<sup>th</sup> May, 2004, the firm was formed as a Government Company in accordance with section 617 of the Companies Act, 1956. It began operating from 1<sup>st</sup> June, 2004.

The company's corporate and registered office is located in Vidyut Bhawan, Saharanpur Road, Majra, Dehradun, next to the ISBT Crossing.

## **2.6. *About Central Board of Irrigation & Power (CBIP)***

The Government of India established the Central Board of Irrigation and Power in 1927, making it a Premier Institution. For the past 93 years, CBIP has provided committed services to the nation's professional associations, engineers, and individuals involved in the power, water resources, and renewable energy sectors. While serving the country equally and to great honour, CBIP has developed into an esteemed institution of international significance. CBIP is Indian chapter for 10 international organizations related to Power & Water resources sectors.

CBIP is involved in executing various activities such as, International Conferences, Technical Documents Publications, Training Activities, Research & Development, Consultancy Services including Technical, Protection & Safety Audits.

### 3.0. Preliminary Audit of 220/33 kV Chamba Substation

#### 3.1. General Information about Sub-station

Sl. No.	Particulars	Details
1	Substation Name	220/33 kV Chamba Substation
2	Name of Owner Utility	Power Transmission Corporation of Uttarakhand Limited (PTCUL)
3	Voltage Level (s) or highest voltage level	220/33 kV
4	Short circuit current rating of all equipment (for all voltage level)	220 kV = 40 kA/sec, 33 kV = 25 kA/sec
5	Date of commissioning of the substation	23 <sup>rd</sup> September 1980
6	Checking and validation date	20 <sup>th</sup> – 21 <sup>st</sup> February 2024

#### 3.2. Audit Team

**Audit Team (CBIP):**

- Mr. Vijay Barthwal
- Mr. M.R. Chauhan
- Mr. Shivam Gupta
- Mr. Avichal Pandey

**PTCUL Representative:**

- Er. Harsh Verma, Executive Engineer (T&C)
- Er. L.P Purohit, Executive Engineer (O&M)
- Er. Pankaj Kailkura, Assistant Engineer (T&C)
- Er. Vinod Purohit, Assistant Engineer (O&M)

### ***3.3. Recommendation of last protection checking and validation***

The Protection Audit of 220/33kV is done for the first time.

### ***3.4. Review of existing settings at substation***

- a. Utility has provided relay settings adopted for various feeders and transformers.
- b. The record of different relay setting calculations is not available at the substation level.
- c. All relays are numeric, therefore, as per internal protocol of utility relays are tested only at the time of commissioning/change in setting. Copy of test reports not available at substation level.

### ***3.5. Disturbance Recorder availability for the last 6 tripping's***

- a. No separate DR/ EL is provided. The DR and EL data are taken from individual numerical relays and SAS.
- b. The inputs from DR reports from numerical relays are available in the server and can be downloaded using LAN cable.
- c. For each tripping data is sent to head office for records.
- d. The Utility has shown data for last 6 trippings.

### ***3.6. Chronic reason of tripping, if any***

- e. Based on list of tripping submitted by utility for last 7 months (April 2023 to October 2023), it is noticed that multiple tripping of 25 MVA transformer either alone or along with 50 MVA transformer have been noticed on HV/LV O/C +C/F protection, due to the fault in 33 kV feeders/Bus bars. The relay settings of Transformers, Feeders were reused and coordinated. Now no trippings were observed from November 2023 onwards.
- f. The tripping timings of CBs was got tested from the third party. In case the 33 kV breakers operation time is high the necessary remedial measures may be planned.



### ***3.7. Major non-conformity/deficiency observed***

- a. The SAS is working partially, some analog and digital signal are not appearing. SAS System requires updation and upgradation.
- b. All the relays and SAS are time synchronised. However, the GUI for SAS is taking time display from Windows OS of individual PC therefore regular time updation of Windows OS server need to be done.
- c. The display clock in the control room, which is slave of the GPS system is defective and showing time error of more than half hour.
- d. No Bus bar protection has been provided.
- e. 220 kV switchyard is provided with one Main Bus and one Transfer Bus. Both the transformers are connected to one 220 kV Auxiliary Bus. This Auxiliary Bus can be connected to either Main Bus or Transfer Bus through isolator. Therefore, if there is any fault in Auxiliary Bus. Both the transformers would bear idle. Also the TBC breaker cannot feed individual transformers.
- f. Two 220 kV Circuit breakers (Dharashu and Rishikesh) are having pneumatic control and facing operational problems. Utility has done detail testing of all 220 Circuit Breakers through third party and reports are pending. Based on the report suitable action for replacement of Circuit Breakers may be taken.
- g. 24 MW BHP and 304 MW Dhrashu Hydro Plant at 220 kV level. In addition, multiple distributed solar plant of more than 10 MW capacity are connected at different feeders of 33 kV site.
- h. Currently auxiliary supply is provided by 250 kVA station Transformer and 15 kVA DG set is provided as back up. In order to provide reliability, the station Transformer can be fed from two sections of 33 kV Bus bar. Utility is planning to install second Station Transformer.
- i. There are two Nos of 110 V DC auxiliary supply is provided and no earth fault is noticed.
- j. Only one 48V DC system is provided along with two set of chargers but both chargers are not working satisfactorily.
- k. The whole system is designed for single DC source; therefore, DC supply to different Relays /Buses/SAS is distributed among both DCDBS on single source basis.

## 4.0. List of Trippings

Name of Feeder/TF	CB No.	Type of Relay /	Date Time of Tripping	Date & Time of closing	flags observed	Other end flag	affected generation/	Tripping Analysis / Action taken report	Category Code	Action Taken
25 MVA T/F (220/33 KV)	882/382	Argus	30-03-2023 18:30 hrs	30-03-2023 18:53 hrs	C.P. : H.V. & L.V. O/C & E/F Prot. Operated R.P.: H.C O/C & E/F Prot. Optd. Ia=6.13xIn Ib= 5.68xIn Ic= 0.31xIn Ie= 5.15xIn Tripping relay 86	NA	Nil	33KV Thatur feeder "R phase" C.T. Blast on feeder fault thatur feeder triped on O/C & E/F prot.	SICT	33 KV Thatur feeder R phase C.T. Replacemnt & Testing work in progress
50 MVA T/F (220/33 KV)	881/381	Micom P143	30-03-2023 18:30 hrs	30-03-2023 18:51 hrs	C.P : L.V. O/C & E/F prot. Optd. R.P.: Active group 1, start phase ABN, trip phase AN , O/C trip ,E/F trip Ia=5.43 Kamp Ib=313 A Ic= 130 A In=5.62 Kamp	NA	Nil	33KV Thatur feeder "R phase" C.T. Blast on feeder fault thatur feeder triped on O/C & E/F prot.	SICT	33 KV Thatur feeder R phase C.T. Replacemnt & Testing work in progress
25 MVA T/F (220/33 KV)	882/382	Argus	19-04-2023 20:51 hrs	19-04-2023 21:15 hrs	C.P. : H.V. /L.V. O/C & E/F prot. Operated R.P. :O/C & E/f protection operated, tripping relay 86	NA	Nil	Transformer trip with heavy jerk tripping on 33 KV NTT-2 feeder	LEFT	NA
50 MVA T/F (220/33 KV)	881/381	Argus	21-04-2023 03:56 hrs	21-04-2023 04:24 hrs	C.P.: O/C E/F protection operated R.P.: H.V./L.V. Over current & earth fault protection operated, tripping relay 86	Nil	nil	Tranformer trip with heavy zerk tripping on NTT2 feeder	LEFT	33 KV NTT2 feeder C.B. Take time to clear fault, feeder tripping circuit time & C.B. Operat ion's check
25 MVA	882/382	Micom	21-04-2023	21-04-2023 04:23 hrs	C.P. : L.V. O/C & E/F prot.optd.	Nil	nil	Tranformer trip with	LEFT	NA

Name of Feeder/TF	CB No.	Type of Relay /	Date Time of Tripping	Date & Time of closing	flags observed	Other end flag	affected generation/	Tripping Analysis / Action taken report	Category Code	Action Taken
T/F (220/33 KV)			03:56 hrs		R.P.: Active group 1, stat phase A,B, trip phase ABC , O/C Trip, E/F trip Ia=5.08 Ka Ib=5.04Ka Ic=96 A			heavy zerk tripping on NTT2 feeder		
50 MVA 220/33 kv T/F	881/381	Microm	03.05.23 15:38 hrs	03.05.23 16:11 hrs	C.P.: L.V. O/C & E/F Protection operated R.P.: Active group 1, start phase BC , Trip phase ABC, O/C start, O/C I>> Trip, Ia=216A Ib=5.77kA Ic=5.54 Kamp	nil	nil	Due to blast in UPCL Metering cubical at 33 kv switch yard while given try to 33 kv B.P. I feeder	NA	NA
25 MVA 220/33 kv T/F	881/381	Easun	03.05.23 15:38 hrs	03.05.23 16:10 hrs	C.P.:H.V./L.V. O/C Protection operated R.P.: Ia=1.90*In Ib=6.22*In Ic=5.90*In	nil	nil		NA	NA
220 KV RKSH-Dharashu-1	82	Siemens 7SA 612	23-05-2023 17:33 hrs	23-05-2023 17:57 hrs	C.P. : Main1 .Main 2 prot. Operated R.P. : Dis pick up L2,L3, definite trip, zone -1 trip , IL1-0.23 Ka IL2=3.72Ka IL3=3.74 ka Distanse=11.00 km tripping relay 86	Dis pick up L2,L3, fault location=2 6.50 km	NA	Transient Line Fault	Phase-Earth fault	Line patrolling required inform to concern line person
220 KV BHP-Ghuttu	81	Microm & GEE	23-05-2023 17:35 hrs	23-05-2023 18:19 hrs	start phae B-N, trip phase ABC, distanse trip zone-2, fault location=46.59km Ia=275 A Ib=158 A Ic=2.49 ka Van=134 Kv Vbn=133.9Kv Vcn=40.28kv	27 MW 17:30 hrs BHP P/H generation affected	Bad Weather heavy storm & rain	Phase-Earth fault	Line patrolling required inform to concern line person	NA
220 KV B.H.P. Ghutu line	81	Microm & GEE	29-05-2023 15:10 hrs	29-05-2023 15:29 hrs	Active group-1, start phase A-N, trip phase ABC, Ia=2.91 Kap Ib=10 A Ic=5 A tripping relay 86	active group 1, start phase A-N ,trip phase ABC, distanse trip zone-1 , fault	27.3 MW BHP P/H generation affected	NA	NA	NA

Name of Feeder/TF	CB No.	Type of Relay /	Date Time of Tripping	Date & Time of closing	flags observed	Other end flag	affected generation/	Tripping Analysis / Action taken report	Category Code	Action Taken
						location= 18.6 km Ia= 260 Amp tripping relay 86				
220 kv Dharashu	81	MIC OM	08-06-2023 14:23 hrs	S/D	Active group 1, start phase B-N distance trip zone 1 IA = 19A, IB = 1.39KA, IC = 21 A Van = 123kv , Vbn = 109kv , Icn = 129.6 kv Fault Location= 37.96 Km Tripping relay 86	Dir. o/c & E/F prot. optd up	24 mw bhp p/h	Transient Line Fault	LEFT	line petroli ng by concer n line person
220 kv Dharashu	81	MIC OM	08-06-2023 14:36 hrs	08-06-2023 18:10 hrs	,active grpoup 1, start phase B-N SOTF trip , IA= 18A, IB= 1.25KA , IC=21A , Van = 122.6kv Vbn = 112kv, Vcn = 129kv Tripping relay 86	NA	NA			
220 kv Dharashu	82	Sie mens	13-06-2023 10:41 hrs	13-06-2023 14:24 hrs	O/C pick up L1-E, Dir. E/F pick up , E/F trip , fault loop L1-E, IL1= 2.26 Ka, IL2= 0.01 Ka IL3=0.01Ka Fault Location= 37.9 Km Tripping relay 863A, 863B	Dir. E/F Prot. Operated	NA	L.A burst Dharasu end	LEFT	L. A chang e by concer n person
25 MVA T/F 220/33 KV	882/382	Arg us	08-09-2023 02:10 hrs	08-09-2023 02:36 hrs	C.P. : H.V. /L.V. O/C & E/F prot. Operated R.P. : O/C prot. Operated IA=6.15xIn IB=6.17xIn IC= 6.03xIn Ie= 0.22 x In tripping relay 86, inter trip relay 86 operated	NA	load at 0.2: 00 hrs 12.8 amp	33 KV B.P.1 feeder UPCL metering cubical 33 KV P.T. Blast at 33 KV Switch yard T/F trip along with 33 KV B.P. I feeder	LEFT	33 KV B.P. Feeder under shut down for testing & cubical replacem ent work by UPCL
220 KV Dharashu	82	Sie mens	19-09-2022 14:27 hrs	19-09-2022 19:19 hrs	O/C pick up L3-E, Dir. E/F pick up, E/F trip , fault loop L3-E,	Dir. E/F Prot. Operated		Due to land slide tree comes in	phase-Earth fault	Fault remov e by concer

Name of Feeder/TF	CB No.	Type of Relay /	Date Time of Tripping	Date & Time of closing	flags observed	Other end flag	affected generation/	Tripping Analysis / Action taken report	Category Code	Action Taken
					IL1= 0.01 Ka IL2= 0.01Ka IL3=0.90Ka fault Loc= 41.40 km tripping relay 863			Line Range create fault		n Line person s
50 MVA T/F 220/33KV C.B. 381 (33KV)	881/381	Micom P143	08-09-2023 02:10 hrs	08-09-2023 02:38 hrs	C.P. : L.V. O/C & E/F prot. Operated R.P.: Active group 1, start phase ABC, tripped phase BC , I>> trip , Ia=372A Ib=5.72Ka Ic=5.38Ka In=8A	NA	load at 0.2:00 hrs 25.4 amp	33 KV B.P.1 feeder UPCL metering cubical 33 KV P.T. Blast at 33 KV Switch yard T/F trip along with 33 KV B.P. I feeder	LEFT	33 KV B.P. Feeder under shut down for testing & cubical replacement work by UPCL
25 MVA T/F 220/33 KV C.B.882 /382	882/382	Argus	10-09-2023 14:18 hrs	10-09-2023 14:31 hrs	C.P. : H.V /L.V O/C & E/F protection operated R.P.: O/C & E/F Protection operated IA= 5.99 x In IB= 6.05 x In IC=5.97 x In Ie= 1.22 x In tripping relay 86 , inter trip relay 86	NA	NA			
25 MVA T/F 220/33 KV	882/382	Argus	11-09-2023 13:26 hrs	11-09-2023 13:40 hrs	C.P.: H.V /L.V O/C & E/F protection operated R.P.: O/C & E/F Protection operated IA= 5.70 x In IB= 6.04 x In IC=5.37 x In Ie= 0.99 x In tripping relay 86 , inter trip relay 86	NA	NA	33 KV B.P. II UPCL metering cubical blast at 33 switch yard at 220 KV S/S transformer trip along with B.P. II feeder	LEFT	metering cubical replacement work by UPCL
220 KV Dharashu	82	Siemens	19-09-2022 14:27 hrs	19-09-2022 19:19 hrs	O/C pick up L3-E, Dir. E/F pick up , E/F trip , fault loop L3-E, IL1= 0.01 Ka IL2= 0.01Ka IL3=0.90Ka fault Loc= 41.40 km tripping relay 863	Dir. E/F Prot. Operated	NA	Due to land slide tree comes in Line Range create fault	phase-Earth fault	Fault remove by concern Line persons
50 MVA T/F	881/381	Micom P143	11-09-2023 13:26 hrs	11-09-2023 13:40 hrs	C.P.: L.V E/F protection operated R.P.: O/C & E/F	NA	NA	NA	LEFT	NA

Name of Feeder/TF	CB No.	Type of Relay /	Date Time of Tripping	Date & Time of closing	flags observed	Other end flag	affected generation/	Tripping Analysis / Action taken report	Category Code	Action Taken
220/33 KV					Protection operated IA= 4.8ka, IB= 1.715ka, IC=6.19ka Ie= 4.217ka tripping relay 86 , inter trip relay 86					
220 KV BHP Ghutu	81	Micom P44 2 GEE Multilin	15-09-2023 04:53 hrs	15-09-2023 05:14 hrs	C.P.: DPT R.P.: Active group-1 , distanse trip, Ia-3.3 Ka Ib= 317 A Ic= 208 A Van=70.26 KV Vbn=136 KV Vcn=132 KV tripping relay 86	NA	NA	Transient line fault bed weather rain & lightning		line patrolling required inform to concern line persons
25 MVA T/F 220/33 KV C.B.882 /382	Argus		15-10-2023 20:45 hrs	15-10-2023 21:17 hrs	C.P. : H.V O/C protection operated LV. O/C protection operated R.P:- Ia-862.9A, Ib-14.31A, Ic- 25.32A Fault duration -281.0 ms, C.B operate time -45.0ms, Relay trip time - 321.0ms, Vac- 215.5KV. Vbc- 230.3KV, Vca- 209.7KV, In- 1450A, Van- 107.2KV, Vbn- 136.6KV, Vcn- 134.5 KV. A= 5.70 x In IB= 6.04 x In . IC=5.37 x In Ie= 0.99 x In tripping relay 86 , inter trip relay 86	NA	NA	Due to Monkey came in range of 33 KV Bus side.	NA	NA
50 MVA T/F 220/33 KV C.B.381	Micom P143		15-10-2023 20:45 hrs	15-10-2023 21:21 hrs	C.P.: HV. DIR O/C & E/F Protection Operated, DIR O/C & E/F Protection Operated R.P. Ia-8.67xIn, Ib-0.43xIn, Ic- 0.43xIn, E/F Ie- 5.75xIn	NA	NA	Due to Monkey came in range of 33 KV Bus side.	NA	NA

Name of Feeder/TF	CB No.	Type of Relay /	Date Time of Tripping	Date & Time of closing	flags observed	Other end flag	affected generation/	Tripping Analysis / Action taken report	Category Code	Action Taken
C.B. 882/382	Argus		17-10-2023 16:23 hrs	17-10-2023 16:10 hrs	C.P. : O/C & E/F Prot. Operated R.P. : I>>trip , Ia= 5.80 x In Ib=5.95xIn Ic= 5.80xIn , Ie= 1.68 x In Tripping relay 86 , Inter trip relay 86IT		NA			
82 Dharashu (38.00 km )	Siemens siprotec 7SA612 7SA52		27-04-2024 19:16 hrs	27-04-2024 23:40 hrs	C.P. : main 1 , main 2 prot. Operated R.P. : Gen trip , R phase Pick up , zone-1 trip, fault location=0.50 km IL1=4.00 Ka IL2=0.21 Ka IL3=0.31 Ka tripping relay 86	Dis. Pick up L1-e, Dis trip 3p on, Def. Trip one , zone-2 trip , fault location=3 8.00km	NA	NA	NA	NA
50 MVA T/F (220/33 KV ) 881/381	Schneider P143		16-05-2024 12:52 hrs	16-05-2024 13:16 hrs	C.P. : O/C & E/F Prot. Operated <u>H.V. Relay :</u> active group-1, start phase C-N , trip phase ABC, O/C I>>trip, E/F In>> trip, IA=63A IB=35A IC=889A IN=940 A <u>L.V. Relay :</u> active group-1, start phase C-N , trip phase ABC, O/C I>>trip, E/F In>> trip, Ia=484 A Ib=229 A IC=5.93KA IN=6.41 KA	NA	NA	NA	NA	NA
82 220KV Chamba - Dharashu Line	Siemens 7SA52 & Siemens 7SA612		20-05-2024 16:51 hrs	20-05-2024 17:11 hrs	O/C pick up on, O/C trip I>1, IL1=0.32 Ka IL2=0.30 Ka IL3=1.15 Ka tripping relay 86	No tripping at Dharshu P/H	Line trip on B phase O/C cascading effect of Chamba	NA	NA	Reviewing Chamba-Dharashu line settings

Name of Feeder/TF	CB No.	Type of Relay /	Date Time of Tripping	Date & Time of closing	flags observed	Other end flag	affected generation/	Tripping Analysis / Action taken report	Category Code	Action Taken
							- BHP line high resis tance fault			



## 5.0. Observations and Recommendations

### 5.1. Reporting of all the Tripping with DR/EL

- a. For the interstate lines, as per IEGC clause 37.2(c) and clause 15.3 of CEA grid standard, all the DR/EL reports shall be uploaded on Web Based Tripping Monitoring System “http://103.7.128.184/Account/Login.aspx” within 24 hours of the events. These are being submitted by sub-station to NRLDC portal, however the record of the same is not kept at substation level.

Status of submission of FIR/DR/EL/Tripping Report on NR Tripping Portal																					
Time Period: 1st January 2024 - 31st January 2024																					
S.No.	Utility	Total No. of tripping	First Information Report (Not Received)		Disturbance Recorder (Not Received)		Disturbance Recorder (NA) as informed by utility		Event Logger (Not Received)		Event Logger (NA) as informed by utility		Event Logger (Not Received)		Tripping Report (Not Received)		Tripping Report (NA) as informed by utility		Tripping Report (Not Received)	Remark	
			Value	%	Value	%	Value	%	Value	%	Value	%	Value	%							
36	SLDC-PS	29	2	7	13	6	57	13	5	54	15	0	55								
37	SLDC-RS	130	12	9	23	11	19	23	9	19	28	0	30								DR, EL & Tripping report need to be submitted
38	SLDC-UK	6	0	0	0	4	0	0	4	0	1	3	33								
39	SLDC-UP	80	10	13	11	9	15	12	33	17	11	1	14								
40	STERILITE	1	0	0	0	0	0	0	0	0	0	1	0								Details received
41	TANAKPUR-NH	4	1	25	1	0	25	1	0	25	1	0	25								DR, EL & Tripping report need to be submitted
42	LINCHAHAR-NT	1	0	0	0	0	0	0	1	0	0	0	0								Details received
Total in NR Region		520	147	28	168	69	37	171	70	38	185	17	37								

*As per the IEGC provision under clause 37.2 (c), detailed tripping report along with DR & EL has to be furnished within 24 hrs of the occurrence of the event*

Ref: NRPC 216 OCC Agenda (Annexure B.VIII)

- b. For the tripping of intra-state lines, the brief tripping reports are submitted to Divisional office. The DR/EL reports are downloaded by respective officials and forwarded, as per need basis. The record of these DR/EL is not kept at sub-stations
- c. It is recommended that each sub-station to have a central repository of such tripping reports, along with DR/EL reports and analysis. A dedicated PC can be kept for this.

### 5.2. Development of centralized database of relay settings

- a. In 48th TCC & 70th NRPC Meeting (held on 17-18 Nov 2023), NRPC Committee has approved for development of a portal through PSDF for Centralized database containing details of relay settings for grid elements connected to 220 kV and above. Portal shall have other features including protection setting calculation tool. A nodal officer shall be providing this data at central portal.
- b. The relay settings for below 220kV are to be calculated by SLDC and/or central level. The relays are tested by sub-station officials as per need basis, but the record of recommended

settings/ calculation is not kept at sub-station level. This makes it difficult to validate the settings and test results, in case of relay testing.

- c. It is recommended that latest recommended relay settings, as decided by RLDC for 220kV & above and by SLDC below 220kV along with setting calculations & parameters used for all the relays be kept at sub-station level. This will help in proper fault analysis and ascertaining relay healthiness.

### **5.3. *Review of test results of relay and equipment***

- a. Testing of most of the equipment is carried out, as per availability of shut-down and testing equipment. After testing, the test records are summarily recorded in testing register, with remarks as “tested. OK”.
- b. For the numeric relay testing, the testing is carried out by supplier at the time of installation and subsequently as per need basis, including at the time of change in settings.
- c. A draft O&M manual is available at PTCUL web-site, which includes various tests and their frequency, along with results. This manual is based on CERC/SERC regulations of 2004-2008. It is recommended that this manual may be updated and implemented and record of test values may be kept for future reference.

### **5.4. *Availability of Testing Kits***

- a. The availability of testing equipment is limited at each substation. For comprehensive testing of equipment, as per above para, sufficient testing kits at each substation/Sub-division/Division level are required.
- b. Based on the O&M manual, it is recommended that sufficient quantity of testing instruments be made available at sites for regular testing of equipment. A suggested list of Testing Equipment is attached at Annexure – 1.

### **5.5. *Up-dation of PTCUL Protection Philosophy***

The protection philosophy adopted by Utility, in general, is in alignment with protection philosophy adopted by NRPC. As the NRPC has recently updated the protection philosophy, PTCUL in consultation with SLDC may update protection philosophy for network not covered by NRPC, if needed, and implement the same.

### **5.6. *Simulation based study of protection system***

As per IEGC, protection code, during audit the relay settings to be adopted shall be validated with simulation based or EMTP studies and details shall be enclosed in report. The current scope of audit was excluding these studies, therefore, Simulation based or EMTP Studies should be carried out by the Utility, as per the requirement of Grid Code.

### **5.7. *Capacity Building of protection team***

During the discussions with officials at site, it was observed that the teams responsible for the protection system and SAS, needs to be updated on current trends on protection system, communication schemes and Sub-station automation. Utility may undertake capacity building exercise for the officials involved in these activities.

### **5.8. *Updated Fault Level/ Short Circuit Level and Network information***

The fault level/ short circuit level for each substation is being calculated at central level. Such studies are carried out, as and when new elements are added in the network. This has impact on relay settings parameters and equipment ratings. It is recommended that the updated network information and short circuit level be maintained at central level for revising the setting as per requirement.

### **5.9. *General Protection related observations***

The study of Fire protection system/ Nitrogen Injection Fire Protection System, Lightning Protection system, Earthing Mat/ Earthing Protection are not covered under protection audit. Utility may get a comprehensive technical and safety audit carried out internally or thru third party and corrective action for any discrepancy be taken up accordingly.

### **5.10. *O&M Manual***

The Utility has a draft O&M manual uploaded on its website, which is being referred by working level officials as a guideline for regular O&M and testing functions. This manual needs to be updated to incorporate recent developments and approved for regular use in all sub-stations to bring uniformity in O&M and testing practices across the utility.

## 6.0. Station Specific Observation and Recommendations

### 6.1. Protection related observations and recommendations

- a. The station is directly connected to 24 MW BHP and 304 MW Dhrashu Hydro Plant at 220 kV level. In addition, PTCUL officials estimated that multiple distributed solar plant of more than 10 MW capacity are connected at different feeders of 33 kV site. Based on the tripping during April 2023 to October 2023, it is noticed that multiple tripping of 25 MVA transformer either alone or along with 50 MVA transformer have been noticed on HV/LV O/C +C/F protection, due to the fault on 33 kV feeders/Bus bars. PTCUL has revised and co-ordinated the relay settings of Transformers and no trippings were reported from November 2023 onwards. It is recommended that whenever new solar plant is added on 33kV side of UPCL system, relay settings be co-ordinated with UPCL.
- b. No Bus-bar protection is provided. It is suggested that PTCUL may examine possibility of providing Bus-bar protection at 220kV level.
- c. The SAS is working partially, some analogue and digital signal are not appearing. SAS System requires up-dation and upgradation.
- d. The display clock in the control room, which is slave of the GPS system is defective and showing time error of more than half hour. This needs to be rectified/ replaced.
- e. All the relays and SAS are time synchronised. However, the GUI for SAS is taking time display from Windows OS of individual PC therefore regular time up-dation of Windows OS server need to be done.

### 6.2. Equipment related observations and recommendations

- a. The sub-station is very old and availability of land is a constraint. 220KV switchyard is provided with one Main Bus and one Transfer Bus. Both the transformers are connected to one 220KV Auxiliary Bus. This Auxiliary Bus can be connected to either Main Bus or Transfer Bus through isolator. The TBC breaker cannot feed individual transformers. This creates problem in maintenance of single transformer. Also, in case of fault in in Auxiliary Bus, both the transformers, and in turn the whole sub-station, would become idle. PTCUL may get the studies carried out for connecting both transformer on separate auxiliary buses and thru TBC for the purpose of reliability and ease of maintenance.
- b. Two 220KV Circuit breakers (Dharashu and Rishikesh) are having pneumatic control and facing operational problems. PTCUL has done detail testing of all 220KV and 33KV Circuit Breakers through third party. The reports of some 33KV breakers have been received and

operation time is high. For 220KV breakers reports are pending. Based on the report suitable action for replacement of Circuit Breakers may be taken.

- c. PTCUL has submitted a list of switchyard equipments to be replaced under PSDF funding, as per Annexure - 2. In view of the need of modern sub-stations, where automation of substation is of paramount importance, these replacements are required. Based on the specifications and healthiness of existing equipments, the list may be reviewed by PTCUL.
- d. In addition, it is recommended that sufficient quantity of maintenance equipments be made available at sites. A suggested list of Maintenance Equipment is attached at Annexure – 3.

### **6.3. *Auxiliary Equipment related observations and recommendations***

- a. Currently auxiliary supply is provided by 250KVA station Transformer and 15KVA DG set is provided as back up. In order to provide reliability, the station Transformer can be fed from two sections of 33KV Bus bar. Utility is planning to install second Station Transformer.
- b. Only one 48V DC system is provided. Currently, no PLCC/ carrier aided tripping is provided, therefore, second 48V DC battery is not required. The existing bank is provided with two set of chargers but both chargers are not working satisfactorily. Necessary action for rectification needs to be taken.
- c. The whole system is designed for single DC source; therefore, 110V DC supply to different Relays /Buses/SAS is distributed among both DCDBS on single source basis. Possibility of dual source DC for protection be examined by PTCUL.

## Annexure – 1: Suggested List of Testing Instruments

CBIP suggests the following list of testing instruments based on the approved O&M manual

Sl. No.	Testing Instruments
1	DCRM for Circuit Breaker
2	DC Earth Fault Locator
3	SF6 Gas Density Monitor
4	SF6 Gas Leakage detector/ Imaging Camera
5	CB Analyser
6	Earth Resistance Tester
7	Portable Digital Selective Level Meter cum Level Generator
8	Selective Level Generator
9	LA Leakage Current Analyser
10	Digital Multi-meter
11	Tong Tester
12	Tan Delta Test Kit
13	Digital Leakage Clamp Meter
14	Phase Sequence Indicator
15	Megger (5 kV)
16	Digital Capacitance Meter
17	CT Polarity Tester
18	PT Test Set

## Annexure – 2: Suggested List of Substation Equipments

The suggested list of Substation Equipments keeping in mind the necessity for the modernization and upgradation of substations.

Sl. No.	Equipment	Unit	Quantity
<b>A</b>	<b>220 kV Equipment</b>		
<b>1</b>	245 kV Cicuit Breaker 3PH	Nos	3
<b>2</b>	245 kV. 1600A,40KA, (3 Phase) HDB Isolator with one E/s (Mettalic & Insulator)	Nos	3
<b>3</b>	245kV Current Transformer (150/75/1)	Nos	3
<b>4</b>	245kV Current Transformer (5 Core), Class 0.2 (1 ph) 800/400/1	Nos	3
<b>5</b>	245 kV CVT 1 Ph	Nos	3
<b>6</b>	216 kV Surge Arrestor 1Ph (Polymer)	Nos	3
<b>B</b>	<b>33 kV Equipment</b>		
<b>1</b>	33 kV Circuit Breaker	Nos	6
<b>2</b>	33 kV Isolator 3Ph with earth switch (800 Amp)	Nos	3
<b>3</b>	33 kV Isolator 3Ph without earth switch (800 Amp)	Nos	3
<b>4</b>	33 kV Current Transformer (3 Core), Class 0.2s (1ph) 800/400/1	Nos	3
<b>5</b>	33 kV Current Transformer (3 Core), Class 0.2s (1ph) 1000/500/1	Nos	3
<b>6</b>	33 kV Current Transformer (3 Core), Class 0.2s (1ph) 400/200/1	Nos	3
<b>7</b>	33 kV PT, 33 kV/110V,50 VA, Class-0.2s	Nos	3
<b>8</b>	33 kV Surge Arrestor 1 Ph (polymer)	Nos	9
<b>9</b>	Construction of 33 kV Jack Bus feeder	Set	1
<b>10</b>	CB Relay Panel with AR	Nos	1
<b>11</b>	Transformer Protection Panel (HV & LV Sides)	Nos	1

### Annexure – 3: Suggested List of Maintenance Equipments

Sl. No.	Equipment
1	Oil Filter Machine
2	SF6 Gas Handling Plant
3	SF6 Gas Density Monitor
4	Thermo-Vision Camera Lines and Sub-Station
5	Binocular Vision Camera
6	SF6 Gas Leakage Imaging Camera
7	LA Leakage Current Analyser
8	Online DGA
9	Oil BDV Kit
10	Hydraulic Crimping Tool for different Types of ACSR Conductor
11	Hydraulic Conductor Cutter
12	Fork Lift 5 Ton Capacity
13	Digital Leakage Clamp Meter

A mobile van with test kits can be kept for optimizing the resources at various substations



## Annexure – 4: Protection Code (IEGC 2023 Chapter 4)

- **General**

1. This chapter covers the protection protocol, protection settings and protection audit plan of electrical systems.
2. There shall be a uniform protection protocol for the users of the grid:
  - a) for proper co-ordination of protection system in order to protect the equipment/system from abnormal operating conditions, isolate the faulty equipment and avoid unintended operation of protection system;
  - b) to have a repository of protection system, settings and events at regional level;
  - c) specifying timelines for submission of data;
  - d) to ensure healthiness of recording equipment including triggering criteria and time synchronization; and
  - e) to provide for periodic audit of protection system.

- **Protection protocol**

1. All users connected to the integrated grid shall provide and maintain effective protection system having reliability, selectivity, speed and sensitivity to isolate faulty section and protect element(s) as per the CEA Technical Standards for Construction, the CEA Technical Standards for Connectivity, the CEA (Grid Standards) Regulations, 2010, the CEA Technical Standards for Communication and any other applicable CEA Standards specified from time to time.
2. Back-up protection system shall be provided to protect an element in the event of failure of the primary protection system.
3. RPC shall develop the protection protocol and revise the same, after review from time to time, in consultation with the stakeholders in the concerned region, and in doing so shall be guided by the principle that minimum electrical protection functions for equipment connected with the grid shall be provided as per the CEA Technical Standards for Construction, the CEA Technical Standards for Connectivity, the CEA Technical Standards for Communication, the CEA (Grid Standards) Regulations, 2010, the CEA (Measures relating to Safety and Electric Supply) Regulations, 2010, and any other CEA standards specified from time to time.

4. The protection protocol in a particular system may vary depending upon operational experience. Changes in protection protocol, as and when required, shall be carried out after deliberation and approval of the concerned RPC.
5. Violation of the protection protocol of the region shall be brought to the notice of concerned RPC by the concerned RLDC or SLDC, as the case may be.

- **Protection settings**

1. RPCs shall undertake review of the protection settings, assess the requirement of revisions in protection settings and revise protection settings in consultation with the stakeholders of the respective region, from time to time and at least once in a year. The necessary studies in this regard shall be carried out by the respective RPCs. The data including base case (peak and off-peak cases) files for carrying out studies shall be provided by RLDC and CTU to the RPCs:
2. All users connected to the grid shall:
  - a) furnish the protection settings implemented for each element to respective RPC in a format as prescribed by the concerned RPC;
  - b) obtain approval of the concerned RPC for,
    - i. any revision in settings, and,
    - ii. implementation of new protection system;
  - c) intimate to the concerned RPC about the changes implemented in protection system or protection settings within a fortnight of such changes;
  - d) ensure correct and appropriate settings of protection as specified by the concerned RPC.
  - e) ensure proper coordinated protection settings.
3. RPCs shall:
  - a) maintain a centralized database and update the same on periodic basis in respect of their respective region containing details of relay settings for grid elements connected to 220KV and above (132KV and above in NER). RLDCs shall also maintain such database.
  - b) carry out detailed system studies, once a year, for protection settings and advise modifications / changes, if any, to the CTU and to all users and STUs of their respective regions. The data required to carry out such studies shall be provided by RLDCs and CTU.

- c) provide the database access to CTU and NLDC and to all users, RLDC, SLDCs, and STUs of the respective regions. The database shall have different access rights for different users.
4. The changes in the network and protection settings of grid elements connected to 220KV and above (132KV and above in NER) shall be informed to RPCs by CTU and STUs, as the case may be.

The elements of network below 66KV and radial in nature which do not impact the National Grid may be excluded as finalized by the respective RPC.

- **Protection audit plan**

1. All users shall conduct internal audit of their protection systems annually, and any shortcomings identified shall be rectified and informed to their respective RPC. The audit report along with action plan for rectification of deficiencies detected, if any, shall be shared with respective RPC for users connected at 220KV and above (132KV and above in NER).
2. All users shall also conduct third party protection audit of each substation at 220KV and above (132KV and above in NER) once in five years or earlier as advised by the respective RPC.
3. After analysis of any event, each RPC shall identify a list of substations / and generating stations where third-party protection audit is required to be carried out and accordingly advise the respective users to complete third party audit within three months.
4. The third-party protection audit report shall contain information sought in the format enclosed as Annexure–1. The protection audit reports, along with action plan for rectification of deficiencies detected, if any, shall be submitted to the respective RPC and RLDC or SLDC, as the case may be, within a month of submission of third-party audit report. The necessary compliance to such protection audit report shall be followed up regularly in the respective RPC.
5. Annual audit plan for the next financial year shall be submitted by the users to their respective RPC by 31<sup>st</sup> October. The users shall adhere to the annual audit plan and report compliance of the same to their respective RPC.
6. Users shall submit the following protection performance indices of previous month to their respective RPC and RLDC on monthly basis for 220KV and above (132KV and above in NER) system, which shall be reviewed by the RPC:
  - a. The Dependability Index defined as

$$D = \frac{Nc}{Nc+Nf}$$

where,

$N_C$  is the number of correct operations at internal power system faults and

$N_f$  is the number of failures to operate at internal power system faults.

- b. The Security Index defined as

$$S = \frac{Nc}{Nc+Nu}$$

where,

$N_C$  is the number of correct operations at internal power system faults

$N_U$  is the number of unwanted operations.

- c. The Reliability Index defined as

$$R = \frac{Nc}{Nc+Ni}$$

where,

$N_C$  is the number of correct operations at internal power system faults

$N_i$  is the number of incorrect operations and is the sum of  $N_f$  and  $N_u$

7. Each user shall also submit the reasons for performance indices less than unity of individual element wise protection system to the respective RPC and action plan for corrective measures. The action plan will be followed up regularly in the respective RPC.
8. In case any user fails to comply with the protection protocol specified by the RPC or fails to undertake remedial action identified by the RPC within the specified timelines, the concerned RPC may approach the Commission with all relevant details for suitable directions.

- **System Protection Scheme (SPS)**

1. SPS for identified system shall have redundancies in measurement of input signals and communication paths involved up to the last mile to ensure security and dependability.
2. For the operational SPS, RLDC or NLDC, as the case may be, in consultation with the concerned RPC(s) shall perform regular load flow and dynamic studies and mock testing for reviewing SPS parameters & functions, at least once in a year.
3. RLDC or NLDC shall share the report of such studies and mock testing including any short comings to respective RPC(s). The data for such studies shall be provided by CTU to the concerned RPC, RLDC and NLDC.
4. The users and SLDCs shall report about the operation of SPS immediately and detailed report shall be submitted within three days of operation to the concerned RPC and RLDC in the format specified by the respective RPCs.
5. The performance of SPS shall be assessed as per the protection performance indices specified in these Regulations. In case, the SPS fails to operate, the concerned User shall take corrective actions and submit a detailed report on the corrective actions taken to the concerned RPC within a fortnight.

- **Recording instruments**

1. All users shall keep the recording instruments (disturbance recorder and event logger) in proper working condition.
2. The disturbance recorders shall have time synchronization and a standard format for recording analogue and digital signals which shall be included in the guidelines issued by the respective RPCs.
3. The time synchronization of the disturbance recorders shall be corroborated with the PMU data or SCADA event loggers by the respective RLDC. Disturbance recorders which are non-compliant shall be listed out for discussion at RPC.

## **Annexure – 5: Third Party Protection System Checking & Validation Template for a Substation (IEGC 2023 Annexure – 1)**

### **1. Introduction:**

- a. The audit reports, along with action plan for rectification of deficiencies found, if any, shall be submitted to RPC or RLDC within a month of submission of report by auditor.
- b. The third-party protection system checking shall be carried at site by the designated agency. The agency shall furnish two reports:
  - i. Preliminary Report: This report shall be prepared on the site and shall be signed by all the parties present.
  - ii. Detailed Report: This report shall be furnished by agency within one month after carrying out detailed analysis.

### **2. Checklist:**

- a. The protection system checklist shall contain information as per this Regulation.
  - i. General Information (to be provided prior to the checking as well as to be included in final report):
    - Substation name
    - Name of Owner Utility
    - Voltage Level (s) or highest voltage level
    - Short circuit current rating of all equipment (for all voltage level) (v) Date of commissioning of the substation
    - Checking and validation date
    - Record of previous tripping's (in last one year) and details of protection operation
    - Previous Relay Test Reports
    - Overall single line diagram (SLD) (x) AC aux SLD
    - DC aux SLD
    - SAS architecture diagram
    - SPS scheme implemented (if any)

b. The preliminary report shall inter-alia contain the following:

**FORMAT OF PRELIMINARY REPORT**

S. No.	Issues	Remarks
<b>1</b>	Recommendation of last protection checking and validation	Status of works & pending issues if any
<b>2</b>	Review of existing settings at substation	Recommended Action
<b>3</b>	Disturbance Recorder out/ available for last 6 trippings (Y/N)	Recommended Action
<b>4</b>	Chronic reason of tripping, if any	Recommended Action
<b>5</b>	Major non-conformity/deficiency observed	Recommended Action

c. The **relay configuration check-list** for available power system elements at station:

- Transmission Line
- Bus Reactor/Line Reactor
- Inter-connecting Transformer
- Busbar Protection Relay
- AC auxiliary system
- DC auxiliary system
- Communication system
- Circuit Breaker Details
- Current Transformer details
- Capacitive Voltage Transformers Details
- Any other equipment/system relevant for protection system operation

d. The **minimum set of points on which checking & validation** shall be carried out is covered in this clause. The detailed list shall be prepared by checking and validation team in consultation with concerned entity, RLDC and RPC.

**i. Transmission Line Distance Protection/Differential Protection;**

- Name and Length of Line
- Whether series compensated or not
- Mode of communication used (PLCC/OPGW)

- Relay Make and Model for Main-I and Main-II
- List of all active protections & settings
- Carrier aided scheme if any
- Status of Power Swing/Out of Step/SOTF/Breaker Failure/Broken Conductor/STUB/Fault Locator/DR/VT fuse fail/Overvoltage Protection/Trip Circuit supervision/Auto-reclose/Load encroachment etc.
- Relay connected to Trip Coil-1 or 2 or both i. CT ratio and PT ratio
- Feed from DC supply-1 or 2
- Connected to dedicated CT core (mention name)
- Other requirements for protection checking and validation

**ii. Shunt Reactor & Inter-connecting Transformer (ICT) Protection;**

- Whether two groups of protections used (Group A and Group B)
- Do the groups have separate DC sources
- Relay Make and Model
- List of all active protections along with settings
- Status of Differential Protection/Restricted Earth Fault Protection/Back-up Directional Overcurrent/Backup Earth fault/ Breaker Failure
- Status of Oil Temperature Indicator/Winding-Temperature Indicator/Bucholz/Pressure Release Device etc.
- Relay connected to Trip Coil-1 or 2 or both
- CT ratio and PT ratio
- Feed from DC supply-1 or 2
- Connected to dedicated CT core (mention name)
- Other requirements for protection checking and validation

**iii. Busbar Protection Relay;**

- Busbar and redundant relay make and model
- Type of Busbar arrangement
- Zones
- Dedicated CT core for each busbar protection (Yes/No)
- Breaker Failure relay included (Yes/No), if additional then furnish make and model
- Trip issued to both Busbar protection in case of enabling
- Isolator indication and check relays



- Other requirements for protection checking and validation

**iv. AC auxiliary system;**

- Source of AC auxiliary system
- Supply changeover between sources (Auto/Manual)
- Diesel generator (DG) details
- Maintenance plan and supply changeover periodicity in DG
- Single Line Diagram
- Other requirements for protection checking and validation

**v. DC auxiliary system;**

- Type of Batteries (Make, vintage, model)
- Status of battery Charger
- Measured voltage (positive to earth and negative to earth)
- Availability of ground fault detectors
- Protection relays and trip circuits with independent DC sources
- Other requirements for protection checking and validation
- Communication system
  - Mode of communication for Main-1 and Main-2 protection
  - Mode of communication for data and speech communication
  - Status of PLCC channels
  - Time synchronization equipment details
  - 7OPGW on geographically diversified paths for Main-1 and main-2 relay
  - Other requirements for protection checking and validation

**vi. Circuit Breaker Details;**

- Details and Status
- Healthiness of Tripping Coil and Trip circuit supervision relay
- Single Pole/Multi pole operation
- Pole Discrepancy Relay available (Y/N)
- Monitoring Devices for checking the dielectric medium
- Other requirements for protection checking and validation
- Current Transformer (CT)/Capacitive Voltage Transformer (CVT) Details
  - CT/CVT ID name and voltage level

- CT/CVT core connection details
- Accuracy Class
- Whether Protection/Metering
- CT/CVT ratio available and ratio adopted
- Details of last checking and validation of CT/CVT healthiness
- Other requirements for protection checking and validation
- Other protections: Direction earth fault, negative sequence, over current, over voltage, over frequency, under voltage, under frequency, forward power, reverse power, out of step/power swing, HVDC protection etc.

### 3. Summary of checking:

The summary shall specifically mention minimum following points:

- a) The settings and scheme adopted are in line with agreed protection philosophy or any accepted guidelines (e.g. Ramakrishna guidelines or CBIP manual based).
- b) The deviations from the RPC protection philosophy, if any and reasons for taking the deviations shall be recorded.
- c) All the major general deficiency shall be listed in detail along with remedial recommendations.
- d) The relay settings to be adopted shall be validated with simulation based or EMTP studies and details shall be enclosed in report.
- e) The cases of protection maloperation shall be analysed from protection indices report furnished by concerned utility, the causes of failure along with corrective actions and recommendations based on the findings shall be noted in the report.

## Annexure – 6: Protection Philosophy/Protocol of Northern Region

The Protection Philosophy/Protocol of Northern Region is developed in compliance of IEGC 2023, Version 2.0 which was approved in 71<sup>st</sup> NRPC meeting held on 29.01.2024.

S.N.	Protection Setting/Protocol	Mandated Setting for transmission lines
1	<b>Protection Scheme</b>	<p>220KV and above: Independent Main-I and Main-II protection (of different make OR different type/different algorithm) of non-switched numerical type is to be provided with carrier aided scheme.</p> <p>132KV and below: One non-switched distance protection scheme and, directional over current and earth fault relays, should be provided as back up.</p>
2	<b>Distance Protection Zone-1</b>	<p>Reach: 80% of the protected line; 110% of the protected line (In case of radial lines) Time Setting: Instantaneous.</p>
3	<b>Distance Protection Zone-2</b>	<p>Reach: Single Circuit Line: 120% of length of principle line section. Double circuit line: 150% coverage of line to take care of under reaching due to mutual coupling effect.</p> <p>Time setting: i. 0.35 second <i>(considering LBB time of 200mSec, CB open time of 60ms, resetting time of 30ms and safety margin of 60ms)</i> ii. 0.5-0.6 second <i>(For a long line followed by a short line)</i></p>

S.N.	Protection Setting/Protocol	Mandated Setting for transmission lines
4	<b>Distance Protection Zone-3</b>	Reach: Zone-3 should overreach the remote terminal of the longest adjacent line by an acceptable margin (typically 20% of highest impedance seen) for all fault conditions. Time Setting: 800-1000 msec If zone-3 reach transcends to other voltage level, time may be taken up to 1.5 sec.
5	<b>Distance Protection Zone- 4</b>	The Zone-4 reverse reach must adequately cover expected levels of apparent bus bar fault resistance. Time may be coordinated accordingly. Where Bus Bar protection is not available, time setting: 160 msec.
6	<b>Lines with Series and other compensations in the vicinity of Substation</b>	<ul style="list-style-type: none"> <li>• Zone-1: FSC end: 60% of the protected line. Time: Instantaneous; Remoted end: 60% of the protected line with 100ms-time delay. POR Communication scheme logic is modified such that relay trips instantaneously in Zone-1 on carrier receive.</li> <li>• Zone-2: 120 % of uncompensated line impedance for single circuit line. For Double circuit line, settings may be decided on basis of dynamic study in view of zero sequence mutual coupling.</li> <li>• Phase locked voltage memory is used to cope with the voltage inversion. Alternatively, an intentional time delay may be applied to overcome directionality problems related to voltage inversion.</li> <li>• Over-voltage stage-I setting for series compensated double circuit lines may be kept</li> </ul>

S.N.	Protection Setting/Protocol	Mandated Setting for transmission lines
		higher at 113%.
7	<b>Power Swing Blocking</b>	<ul style="list-style-type: none"> <li>Block tripping in all zones, all lines.</li> </ul> Out of Step tripping to be applied on all inter-regional tie lines. Deblock time delay = 2s
8	<b>Protection for broken conductor</b>	Negative Sequence current to Positive Sequence current ratio more than 0.2 (i.e. $I_2/I_1 \geq 0.2$ ) Alarm Time delay: 3-20 sec. Tripping may be considered for radial lines to protect single phasing of transformers.
9	<b>Switch on to fault (SOTF)</b>	Switch on to fault (SOTF) function to be provided in distance relay to take care of line energization on fault.
10	<b>VT fuse fail detection function</b>	VT fuse fail detection function shall be correctly set to block the distance function operation on VT fuse failure.
11	<b>Carrier Protection</b>	To be applied on all 220KV and above lines with the only exception of radial feeders.
12	<b>Back up Protection</b>	<ol style="list-style-type: none"> <li>On 220KV and above lines with 2 Main Protections:               <ul style="list-style-type: none"> <li>Back up Earth Fault protections alone to be provided.</li> <li>No Over current protection to be applied.</li> </ul> </li> <li>At 132KV and below lines with only one Main protection:               <ul style="list-style-type: none"> <li>Back up protection by IDMT O/C and E/F to be applied.</li> </ul> </li> </ol>

S.N.	Protection Setting/Protocol	Mandated Setting for transmission lines
13	<b>Auto Reclosing with dead time.</b>	<p>AR shall be enabled for 220KV and above lines for single pole trip and re-closing. Dead time = 1.0s. Reclaim time = 25.0s</p> <p>Auto-recloser shall be blocked for following:</p> <ul style="list-style-type: none"> <li>• Faults in cables</li> <li>• Breaker Fail Relay</li> <li>• Line Reactor Protections</li> <li>• O/V Protection</li> <li>• Received Direct Transfer trip signals</li> <li>• Busbar Protection</li> <li>• Zone 2/3 of Distance Protection</li> <li>• Circuit Breaker Problems.</li> </ul> <p>CB Pole discrepancy relay time:1.5 sec; for tie breaker: 2.5 sec</p>
14	<b>Busbar protection</b>	To be applied on all 220KV and above sub stations with the only exception of 220KV radial fed bus bars.
15	<b>Local Breaker Backup (LBB)</b>	<p>For 220KV and above level substations as well as generating stations switchyards, LBB shall be provided for each circuit breaker.</p> <p>LBB Current sensor <math>I &gt; 20\%</math> In LBB time delay = 200ms</p> <p>In case of variation in CT ratio, setting may be done accordingly.</p>
16	<b>Line Differential</b>	<p>For cables and composite lines, line differential protection with built in distance back up shall be applied as Main-I protection and distance relay as Main-II protection.</p> <p>For very short line (less than 10 km), line differential protection with distance protection as</p>

S.N.	Protection Setting/Protocol	Mandated Setting for transmission lines
		<p>backup (built- in Main relay or standalone) shall be provided mandatorily as Main-I and Main-II.</p> <p>Differential protection may be done using dark fiber (preferably), or using bandwidth.</p>
17	Over Voltage Protection	<p>FOR 765KV LINES/CABLE:</p> <p>Low set stage (Stage-I): 106% - 109% (typically 108%) with a time delay of 5 seconds.</p> <p>High set stage (Stage-II): 140% - 150% with a time delay of 100 milliseconds.</p> <p>400KV LINES/CABLE:</p> <p>Low set stage (Stage-I): 110% - 112% (typically 110%) with a time delay of 5 seconds.</p> <p>High set stage (Stage-II): 140% - 150% with a time delay of 100 milliseconds.</p> <p>FOR 220KV LINES:</p> <p>No over-voltage protection shall be used.</p> <p>FOR 220KV CABLE:</p> <p>Low set stage (Stage-I): 110% - 112% (typically 110%) with a time delay of 5 seconds.</p> <p>High set stage (Stage-II): 140% - 150% with a time delay of 100 milliseconds.</p> <p>Drop-off to pick-up ratio of overvoltage relay: better than 97%</p> <p>Grading: Voltage as well as time grading may be</p>

S.N.	Protection Setting/Protocol	Mandated Setting for transmission lines
		done for multi circuit lines/cable.
18	<b>Resistive reach setting to prevent load point encroachment</b>	<p>Following criteria may be considered for deciding load point encroachment:</p> <ul style="list-style-type: none"> <li>• Maximum load current (Imax) may be considered as 1.5 times the thermal rating of the line or 1.5 times the associated bay equipment current rating (the minimum of the bay equipment individual rating) whichever is lower. (Caution: The rating considered is approximately 15minutes rating of the transmission facility).</li> <li>• Minimum voltage (V min) to be considered as 0.85pu (85%).</li> </ul>
19	<b>Direct Inter-trip</b>	<p>To be sent on operation of following:</p> <ol style="list-style-type: none"> <li>i. Overvoltage Protection</li> <li>ii. LBB Protection</li> <li>iii. Busbar Protection</li> <li>iv. Reactor Protection</li> <li>v. Manual Trip (400KV and above)</li> <li>vi. Cable Fault (in composite lines)</li> </ol>
20	<b>Permissive Inter-trip</b>	To be sent on operation of Distance Protection



## Annexure – 7: Work Order & Corrigendum



पावर ट्रांसमिशन कारपोरेशन ऑफ उत्तराखण्ड लि०  
(उत्तराखण्ड सरकार का उपक्रम)  
अधीक्षण अभियन्ता (परीक्षण एवं परिचालन एवं स्काडा) कार्यालय  
कुमायु मण्डल हल्द्वानी  
मोबाइल नं० 9412089275, ईमेल dp\_singh@ptcul.org

No. 376 /SE (T&C)/PTCUL/ (H)/

Date:29.09.2023

Subject:- Order for Protection Audit of 02 Nos 400 kV and 08 Nos 220KV sub-stations in PTCUL.

Joint Advisor

Central Board of Irrigation and Power

Malcha Marg Chanakyapuri,

New Delhi-110021

Email: mrchauhan@cbip.org.

Dear Sir,

In reference to your offer submitted vide Ref No: P-1/CBIP/PTCUL/PTCUL/Audit/2023 dated: 11.09.2023 through email against Email enquiry dated 05.09.2023, an order is hereby placed in favour of your firm for the work of "Protection Audit of 02 Nos 400kV and 08 Nos 220 kV substations of PTCUL". The detail of material, price schedule and terms & conditions is here as under:-

Sr.No	Description	Unit	Qty	Amount	Total Amount
1	Protection Audit to be carried out for the following 10 nos of the 400/220kV substations of PTCUL :- 1. 400kV S/s Rishikesh 2. 400 kV S/s Kashipur 3. 220kV S/s Chamba 4. 220kV S/s Rishikesh 5. 220kV S/s Roorkee 6. 220kV S/s Haridwar (SIDCUL) 7. 220kV S/s Jhajra. 8. 220 kV S/s Pantnagar. 9. 220 kV S/s Haldwani. 10. 220kV S/s Mahuakheraganj.	Job	1	36,25,000	36,25,000
	TOTAL				36,25,000

Total value of order is Rs.36,25,000 (Rupees Thirty Six Lakh Twenty Five Thousand only ) Plus GST Extra.

End: 1. Terms & Conditions.

Please acknowledge the receipt and acceptance of order.

(D.P Singh)

Superintending Engineer (T&C), Haldwani

No.376 /SE (T&C)/PTCUL/ (H)/

Date:29.09.2023

Copy forwarded to the following for information and necessary action:-

1. Director (Operation), PTCUL, Dehradun.
2. Superintending Engineer (A) MD, PTCUL, Dehradun.
3. Chief Engineer, T&C PTCUL, 132kV Substation Campus, Kathgodam Nainital.
4. Executive Engineer, T&C Division, Kashipur.
5. Director (Energy), Central Board of Irrigation and Power Malcha Marg Chanakyapuri, New Delhi-110021 Email: [sanjeev@cbip.org](mailto:sanjeev@cbip.org)

(D.P Singh)

Superintending Engineer (T&C), Haldwani

मुख्यालय एवंपंजीकृत कार्यालय:-विद्युतमवन, नजदीक-आई०एस०बी०टी० क्रॉसिंग, सहारनपुररोड, माजरा, देहरादून-248002  
कारपोरेटआईडी नं०: U40101UR2004GOI028675 दूरभाष नं० 0135-2646000 फैक्स नं० 0135-2643460 वेबसाइट [www.ptcul.org](http://www.ptcul.org)



पावर ट्रॉसमिशन कारपोरेशन ऑफ उत्तराखण्ड लि०  
(उत्तराखण्ड सरकार का उपक्रम)  
अधीक्षण अभियन्ता (परीक्षण एवं परिचालन एवं स्काडा) कार्यालय  
कुमायु मण्डल हल्द्वानी  
मोबाइल नं० 9412089275, ईमेल dp\_singh@ptcul.org

Terms & Conditions:-

1	Scope	<p>: The detailed Scope work is as under:</p> <ol style="list-style-type: none"><li>1. There must be a kick off meeting for discussion on project plan before start of the work in field and the detailed plan of performance shall be submitted by CBIP.</li><li>2. Requisite data shall be collected in standard format from PTCUL grid substations by authorized and experienced auditor.</li><li>3. The site surveys and audit of grid substations of PTCUL shall be done by authorized and experienced auditor.</li><li>4. Review of the implemented protection schemes/philosophy for 400/220 kV substations which includes protection of transmission lines,interconnecting transformers, line/busreactors, bus bar, bus couplers etc.as per latest guidelines of Ramakrishna committee/CBIP/NRPC/Intenational best practices,etc.</li><li>5. Review the adequacy of primary and backup protection settings for protected equipment and suggest corrective measures where evernon compliance with respect to Ramakrishna committee/ CBIP/NRPC is found during the protection audit.</li><li>6. Review of availability/healthiness of PLCC communication links used for protection systems.</li><li>7. Review the healthiness/adequacy of 220/110/50V DC system available at substations for protection application.</li><li>8. Review of availability/healthiness of GPS system and time synchronization facility used for protection.</li><li>9. Review of availability/healthiness of recording instruments like DRs /ELs for transmission lines protection.</li><li>10. Review of test reports for assessing the healthiness of circuit breakers, CT &amp; CVT based upon available test reports at sites.</li><li>11. Field inspection of protection device for obsolescence of technology, suitability and healthiness.</li><li>12. Directory of the protection system &amp; recommendation for replacement of obsolescence relays with compatible numerical relays will be provided.</li><li>13. Checking of availability of DGset/auxiliary DC supply at substations.</li><li>14. Site visits for onsite protection audit, review and inspection of substations will be performed.</li><li>15. Submission of the detailed report for the protection audit including the protection philosophy, reviewed settings and protection audit observations.</li><li>16. The performance of above protection equipment like relays, circuit breaker, CT, CVT, DC battery bank, synchro facility, communication facility used for protection will be also checked through physical inspection and provided test reports/documents. These protection equipments will be recommended for renovation and upgradation based on their performance accessed during protection audit and physical inspection.</li><li>17. Review the availability healthiness of<ul style="list-style-type: none"><li>• Event recorders/ loggers' operation history</li><li>• CT, CVT, CB</li><li>• DC power supply</li><li>• Auxiliary supply</li><li>• Communication links</li><li>• Time synchronization/ GPS</li></ul></li><li>18. Review of Testing and Maintenance records of all protective relays, Circuit Breakers CT, CVT etc. Review of protection philosophy.</li></ol>
---	-------	--

मुख्यालय एवंपजीकृत कार्यालय:-विद्युतमवन, नजदीक-आई०एस०बी०टी० क्रासिंग, सहारनपुररोड, माजरा, देहरादून-248002  
कारपोरेटआईडी नं०: U40101UR2004GOI028675 दूरभाष नं० 0135-2646000 फ़ैक्स नं० 0135-2643460 वेबसाइटwww.ptcul.org



**पावर ट्रांसमिशन कारपोरेशन ऑफ उत्तराखण्ड लि०**  
(उत्तराखण्ड सरकार का उपक्रम)  
**अधीक्षण अभियन्ता (परीक्षण एवं परिचालन एवं स्काडा) कार्यालय**  
**कुमायु मण्डल हल्द्वानी**  
मोबाइल नं० 9412089275, ईमेल dp\_singh@ptcul.org

			19. Anything which is left to be mentioned here but required for successful completion of the aforementioned subject work shall be done <b>Central Board of Irrigation and Power Malcha Marg Chanakyapuri, New Delhi-110021</b> 20. CBIP Delhi shall submit a report on detailed points in four sets of hard copy duly spiraled binding as well as soft copy shall be submitted. 21. The safety guidelines prevalent in PTCUL must be followed.
2	GST	:	GST shall be paid extra as per applicable Government rules.
3	Tax	:	Tax shall be deducted at source as per applicable Government rules. A certificate to this effect may be given to the Contractor if required.
4	Date of Start of work	:	Order shall be considered as having come in to force from the date of issue of order.
5	Supply Completion	:	NA
6	Work completion	:	The work should be completed within 24 months from the date of issue of order.
7	Engineer of the contract	:	Superintending Engineer (T&C), Haldwani is the "Engineer of the contract" who shall be placing the order for the work with the contractor and signing the contract agreement and who has been inherently vested with such powers by corporation in this behalf and shall act as Engineer for the purpose of the contract.
8	Engineer in-charge	:	<b>Respective Executive Engineer (T&amp;C) shall be "Engineer in charge"</b> for the subject work.
9	Liquidity damages	:	If the contract is delayed beyond the stipulated period mentioned in the contract. The liquidity damages shall be levied @ 0.5 % per week and maximum up to 10% of contract value.
10	Dispute	:	All Dispute arising out of this case under the jurisdiction local court at Kashipur and Honable High Court, Nainital.
11	Payment terms	:	1. 25% Payment will be made within 30 days after finalization of Audit plan, subject to availability of funds from PTCUL HQ. 2. 35% Payment will be made within 30 days after submission of preliminary reports verified by Executive Engineer of respective division, subject to availability of funds from PTCUL HQ. 3. 40 % Payment will be made within 30 days after submission of final reports verified by Executive Engineer of respective division, subject to availability of funds from PTCUL HQ.
12	Payment unit	:	Test & Commissioning Division, Kashipur shall be the payment unit and all units where is to be work done shall record the measurement and duly passed bills along with measurement book shall be submitted to payment unit.
13	Warranty period	:	NA.
14	Billing Address	:	Executive Engineer Test & Commissioning Division, PTCUL 400 KV Substation Campus, Kashipur (Uttarakhand)-244713, GSTIN No. (05AAECM1785FC29)

All other term and condition of this order shall be governed by the General conditions of the contract prevalent in PTCUL.

  
(D.P Singh)

Superintending Engineer(T&C), Haldwani

मुख्यालय एवंपंजीकृत कार्यालय:-विद्युतमवन, नजदीक-आई०एस०बी०टी० क्रासिंग, सहारनपुररोड, गाजरा, देहरादून-248002  
कारपोरेटआईडी नं०: U40101UR2004GOI028675 दूरभाष नं० 0135-2646000 फैक्स नं० 0135-2643460 वेबसाइट [www.ptcul.org](http://www.ptcul.org)





पावर ट्रॉसमिशन कारपोरेशन ऑफ उत्तराखण्ड लि०  
(उत्तराखण्ड सरकार का उपक्रम)  
अधीक्षण अभियन्ता (परीक्षण एवं परिचालन एवं स्काडा) कार्यालय  
कुमायु मण्डल हल्द्वानी  
मोबाइल नं० 9412089275, ईमेल dp\_singh@ptcul.org

No. 394 /SE (T&C)/PTCUL/ (H)/

Date:26.10.2023

Subject:- Corrigendum for the Order for the work of Protection Audit of 02 Nos 400 kV and 08 Nos 220KV sub-stations in PTCUL

Joint Advisor

Central Board of Irrigation and Power

Malcha Marg Chanakyapuri,

New Delhi-110021

Email: mrchauhan@cbip.org.

Dear Sir,

In reference to above mentioned subject, please refer to kick off meeting held on dated 26.10.2023 for the work of Protection Audit of 02 Nos 400 kV and 08 Nos 220KV sub-stations in PTCUL against order no.376 dated 29.09.2023.

In this regard, kindly find enclosed herewith corrigendum of order no.376 dated 29.09.2023 (Annexure-1) with necessary amendments as discussed in afforementioned meeting.

This is for your kind information and necessary action.

Please acknowledge the receipt and acceptance of order.

(D.P Singh)

Superintending Engineer (T&C), Haldwani

Copy forwarded to the following for information and necessary action:-

1. Chief Engineer, T&C PTCUL, 132kV Substation Campus, Kathgodam Nainital..
2. Executive Engineer, T&C Division, Roorkee/Dehradun/Haldwani/Kashipur/Rishikesh with request to provide assistance and information to CBIP for the above work.
3. Director (Energy), Central Board of Irrigation and Power Malcha Marg Chanakyapuri, New Delhi-110021  
Email: [sanjeev@cbip.org](mailto:sanjeev@cbip.org)

मुख्यालय एवं पंजीकृत कार्यालय:- विद्युतमवन, नजदीक-आई०एस०बी०टी० क्रॉसिंग, सहारनपुररोड़, माजरा, देहरादून-248002  
कारपोरेटआईडी नं०: U40101UR2004GOI028675 दूरभाष नं० 0135-2646000 फॅक्स नं० 0135-2643460 वेबसाइट [www.ptcul.org](http://www.ptcul.org)

Annexure -1 – Work order corrigendum

Scope: The detailed Scope work is as under:

S. No.	Clause of PO	Existing Clause					Modified Clause						
		Sr. No	Description	Unit	Qty	Amount	Total Amount	Sr. No	Description	Unit	Qty	Unit rate (Rs.)	Total Amount (Rs.)
1	Price Schedule	1	Protection Audit to be carried out for the following 10 nos. of the 400/220kV substations of PTCUL:- 1. 400kV S/s Rishikesh 2. 400 kV S/s Kashipur 3. 220kV S/s Chamba 4. 220kV S/s Rishikesh 5. 220kV S/s Roorkee 6. 220kV S/s Haridwar (SIDCUL) 7. 220kV S/s Jhajra 8. 220 kV S/s Pantnagar. 9. 220 kV S/s Haldwani. 10. 220kV S/s Mahuaikheraganj.	Job	1	36,25,000	36,25,000	1	Protection Audit to be carried out for the following 10 nos of the 400/220kV substations of PTCUL:- 1. 400kV S/s Rishikesh 2. 400 kV S/s Kashipur 3. 220kV S/s Chamba 4. 220kV S/s Rishikesh 5. 220kV S/s Roorkee 6. 220kV S/s Haridwar (SIDCUL) 7. 220kV S/s Jhajra 8. 220 kV S/s Pantnagar 9. 220 kV S/s Haldwani 10. 220kV S/s Mahuaikheraganj)	Each	10	3,62,500	36,25,000
		TOTAL					36,25,000	TOTAL					36,25,000
2	Terms and Conditions S. No. 1 – Scope	1.	There must be a kick off meeting for discussion on project plan before start of the work in field and the detailed plan of performance shall be submitted by CBIP.					1. There must be a kick off meeting for discussion on project plan before start of the work in field and the detailed plan of performance shall be submitted by CBIP.					
		2.	Requisite data shall be collected in standard format from PTCUL grid substations by authorized and experienced auditor.					2. Requisite data shall be collected in standard format from PTCUL grid substations by an experienced auditor.					
		3.	The site surveys and audit of grid substations of PTCUL shall be done by authorized and experienced auditor.					3. The site surveys and audit of grid substations of PTCUL shall be done by an experienced auditor.					
		4.	Review of the implemented protection schemes/ philosophy for 400/220 kV substations which includes protection of transmission lines, interconnecting transformers, line/bus reactors, bus bar, bus					4. Review of the implemented protection schemes/philosophy for 400/220 kV substations which includes protection of transmission lines, interconnecting transformers, line/bus reactors, bus bar, bus couplers etc with respect to					





5. Clause of PO	Existing Clause	Modified Clause
No.	<p>couplers etc.as per latest guidelines of Ramakrishna committee/ CBP/NRPC/international best practices.etc.</p> <p>5. Review the adequacy of primary and backup protection settings for protected equipment and suggest corrective measures where everyone compliance with respect to Ramakrishna committee/ CBP/NRPC is found during the protection audit.</p> <p>6. Review of availability/healthiness of PLCC communication links used for protection systems.</p> <p>7. Review the healthiness/adequacy of 220/110/50V DC system available at substations for protection application.</p> <p>8. Review of availability/healthiness of GPS system and time synchronization facility used for protection.</p> <p>9. Review of availability/healthiness of recording instruments like DIRs /ELs for transmission lines protection.</p> <p>10. Review of test reports for assessing the healthiness of circuit breakers, CT &amp; CVT based upon available test reports at sites.</p> <p>11. Field inspection of protection device for obsolescence of technology, suitability and healthiness.</p> <p>12. Directory of the protection system &amp; recommendation for replacement of obsolescence relays with compatible numerical relays will be provided.</p> <p>13. Checking of availability of DG Set/auxiliary DC supply at substations.</p> <p>14. Site visits for onsite protection audit, review and inspection of substations will be performed.</p> <p>15. Submission of the detailed report for the protection audit including the protection philosophy, reviewed settings and protection audit observations.</p> <p>16. The performance of above protection equipment like relays, circuit breaker, CT, CVT, DC battery bank, synchro facility, communication facility used for protection will be also checked through physical inspection and provided test reports/documents. These protection equipment's will be recommended for renovation and upgradation based on their performance accessed during protection audit and physical inspection.</p>	<p>tripping in last one year as per latest guidelines of Ramakrishna committee/ CBP/NRPC/international best practices, which includes review of the following:</p> <p>a) Adequacy of primary and backup protection settings for protected equipment and suggest corrective measures</p> <p>b) Availability/healthiness of PLCC communication links used for protection systems.</p> <p>c) Healthiness/adequacy of 220/110/50V DC system available at substations for protection application.</p> <p>d) Availability/healthiness of GPS system and time synchronization facility used for protection.</p> <p>e) Availability/healthiness of recording instruments like DIRs /ELs for transmission lines protection.</p> <p>f) Test reports for assessing the healthiness of circuit breakers, CT &amp; CVT based upon available test reports at sites.</p> <p>g) Field inspection of protection device for obsolescence of technology, suitability and healthiness.</p> <p>h) Prepare recommendation for replacement of obsolescence relays with compatible numerical relays will be provided.</p> <p>i) Checking of availability of DG Set / auxiliary DC supply at substations.</p> <p>5. Site visits for onsite protection audit, review and inspection of substations will be performed</p> <p>6. Submission of the detailed report for the protection audit including the protection philosophy, reviewed settings and protection audit observations.</p>
		<p>Deleted as it is covered in point 4 above.</p>







3



S. No.	Clause of PO	Existing Clause	Modified Clause
		<p>17. Review the availability healthiness of</p> <ul style="list-style-type: none"> <li>• Event recorders/ loggers' operation history</li> <li>• CT, CVT, CB</li> <li>• DC power supply</li> <li>• Auxiliary supply</li> <li>• Communication links</li> <li>• Time-synchronization/ GPS</li> </ul> <p>18. Review of Testing and Maintenance records of all protective relays, Circuit Breakers, CT, CVT etc. Review of protection philosophy.</p> <p>19. Anything which is left to be mentioned here but required for successful completion of the aforementioned subject work shall be done Central Board of Irrigation and Power Malcha Marg Chanakyapuri, New Delhi-110021</p> <p>20. CBIP Delhi shall submit a report on detailed points in four sets of hard copy duly spiraled binding as well as soft copy shall be submitted.</p> <p>21. The safety guidelines prevalent in PTCUL must be followed.</p>	<p>7. Anything which is left to be mentioned here but required for successful completion of the aforementioned subject work shall be done by Central Board of Irrigation and Power.</p> <p>8. CBIP Delhi shall submit a protection report on detailed points in four sets of hard copy duly spiraled binding and in soft copy as well.</p> <p>9. The safety guidelines prevalent in PTCUL must be followed.</p>
3	Terms and Conditions - S. No. 6 - Work Completion	The work should be completed within 24 months from the date of issue of order	The work should be completed within 24 weeks from the date of issue of corrigendum.
4	Terms and Conditions - S. No. 8 - Engineer-in-charge	Respective Executive Engineer (T&C) shall be "Engineer in charge" for the subject work.	<p>The following Executive Engineers (T&amp;C) shall be "Engineer in charge" for the subject work:</p> <p>a) 400KV Rishikesh, 220KV Rishikesh, 220 kV Chamba - Mr. Harsh Verma (Ph. No.9412074038 &amp; Email: ee_tandc_rsh@ptcul.org).</p> <p>b) 400KV Kashipur, 220KV Pantnagar, 220KV Haldwani &amp; 220KV Mahaukheraganj - Mr. Asim Baig (Ph. No. 9412087885 &amp; Email: ee_tandc_ksp@ptcul.org).</p> <p>c) 220KV SIDCUL Haridwar, 220 KV Roorkee - Mr. Ashwini Kumar (Ph. No.7088117301 &amp; Email: ee_tandc_ks@ptcul.org).</p> <p>d) 220KV Jhajra - Mr. Ravindra Kumar (Ph. No. 9927744222 &amp; Email: ee_tandc_ddun@ptcul.org).</p>





S. No.	Clause of PO	Existing Clause	Modified Clause
5	Terms and Conditions - 5. No. 11 - Payment Terms	<ol style="list-style-type: none"> <li>1. 25% Payment will be made within 30 days after finalization of Audit plan, subject to availability of funds from PTCUL HQ.</li> <li>2. 35% Payment will be made within 30 days after submission of preliminary reports verified by Executive Engineer of respective division, subject to availability of funds from PTCUL HQ.</li> <li>3. 40 % Payment will be made within 30 days after submission of final reports verified by Executive Engineer of respective division, subject to availability of funds from PTCUL HQ.</li> </ol>	<ol style="list-style-type: none"> <li>1. 25% Payment will be made within 30 days after finalization of Audit plan, subject to availability of funds from PTCUL HQ.</li> <li>2. 35% Payment will be made within 30 days after submission of preliminary reports <b>on prorata basis</b> verified by Executive Engineer of respective division, subject to availability of funds from PTCUL HQ.</li> <li>3. 40 % Payment will be made within 30 days after submission of final reports <b>on prorata basis</b> verified by Executive Engineer of respective division, subject to availability of funds from PTCUL HQ.</li> <li>4. The local travel, lodging &amp; boarding shall be arranged by PTCUL on free-of-cost basis for CBIP team visiting the substation</li> </ol>





## **Annexure – 8: Data Sheets**

# Contents

<b>Single Line Diagrams</b> .....	60
<i>Substation Single Line Diagram</i> .....	60
<i>AC Auxiliary System</i> .....	61
<i>DC Auxiliary System</i> .....	62
<b>Transmission Lines</b> .....	64
<b>Bus-Bar Protection</b> .....	67
<b>AC Auxiliary System</b> .....	68
<b>DC Auxiliary System</b> .....	69
<b>Circuit Breakers</b> .....	70
<b>Current Transformer</b> .....	71
<b>Capacitive Voltage Transformer/Potential Transformer</b> .....	74
<b>Disturbance Recorder (DR) &amp; Event Logger (EL)</b> .....	76
<b>Communication System</b> .....	77
<b>Transformer Protection</b> .....	78
<b>Network Diagram of Uttarakhand</b> .....	81
<b>Power Map of Uttarakhand</b> .....	82

# Protection Audit of 220/33KV Chamba Substation

## Annexure - 8

### Data Sheets

## Single Line Diagrams

### Substation Single Line Diagram

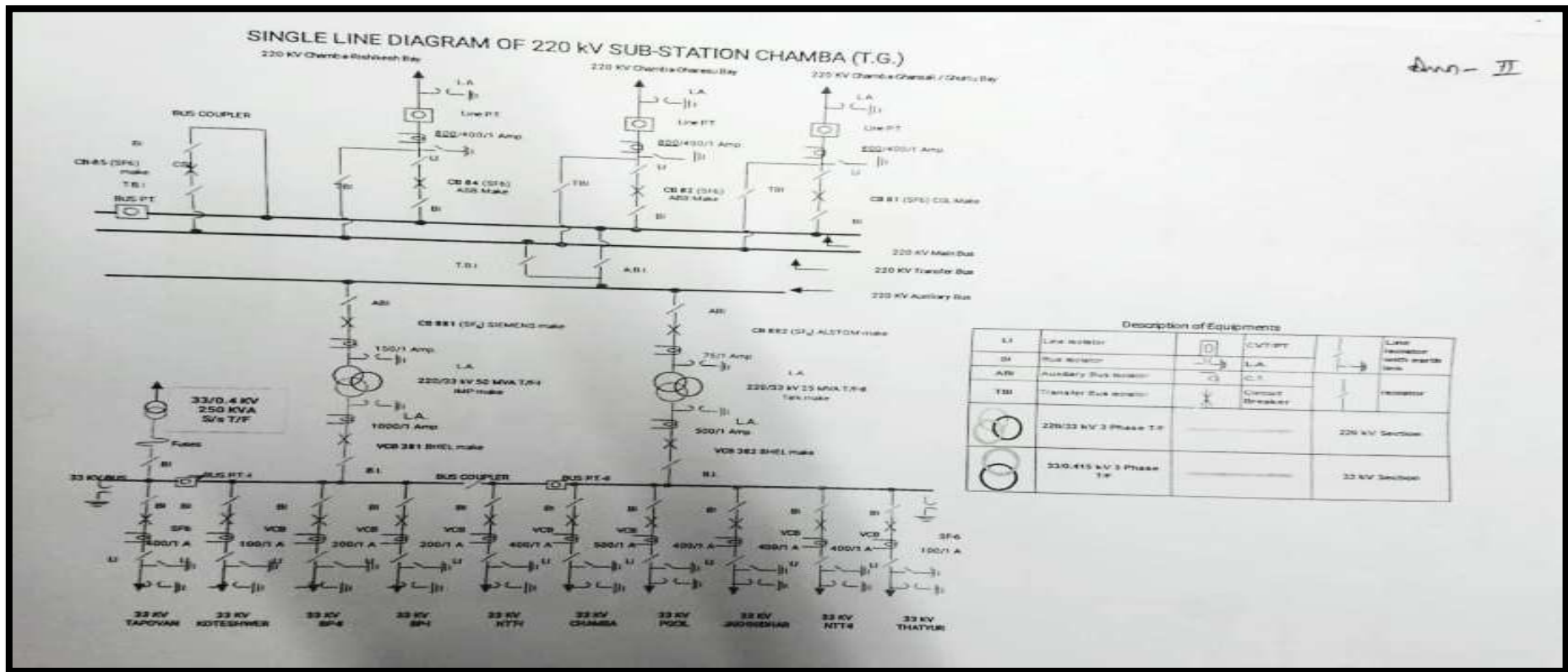

AC Auxiliary System

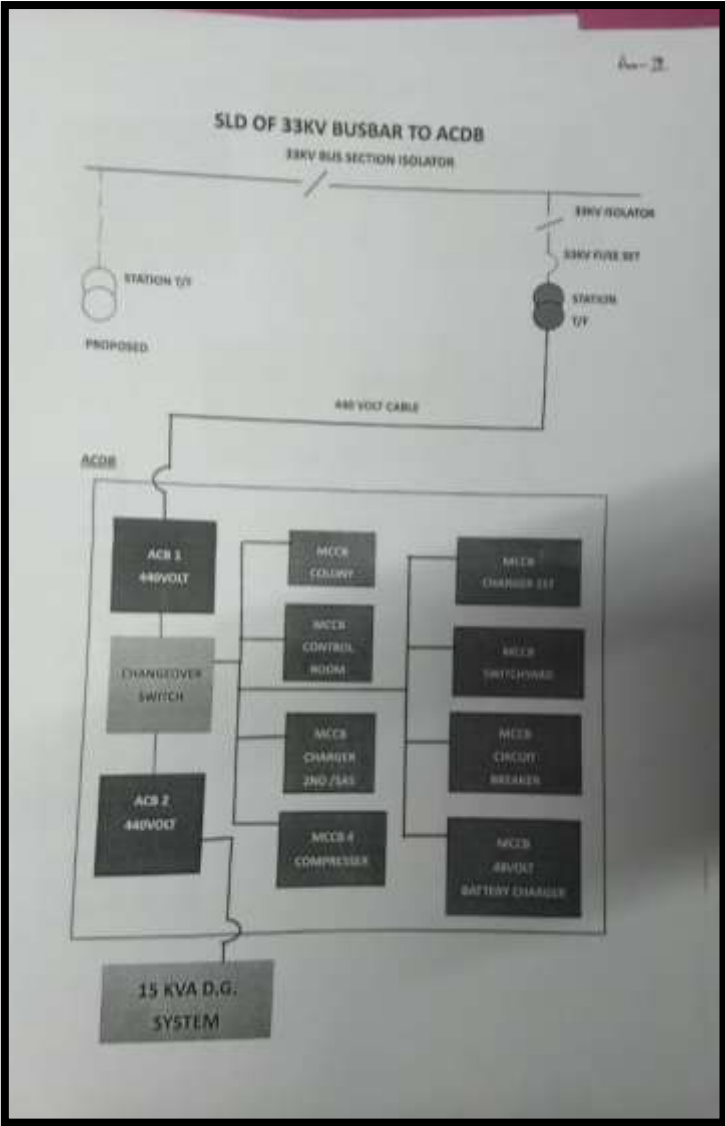

*DC Auxiliary System*

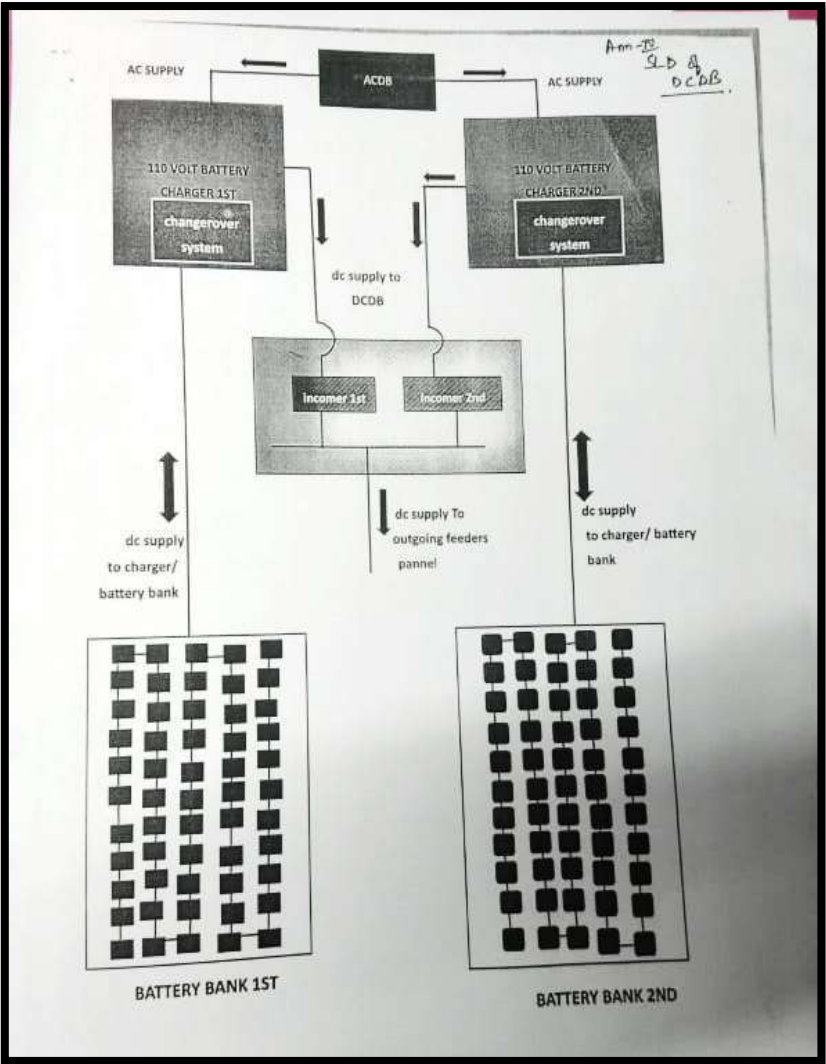

SAS Architecture diagram

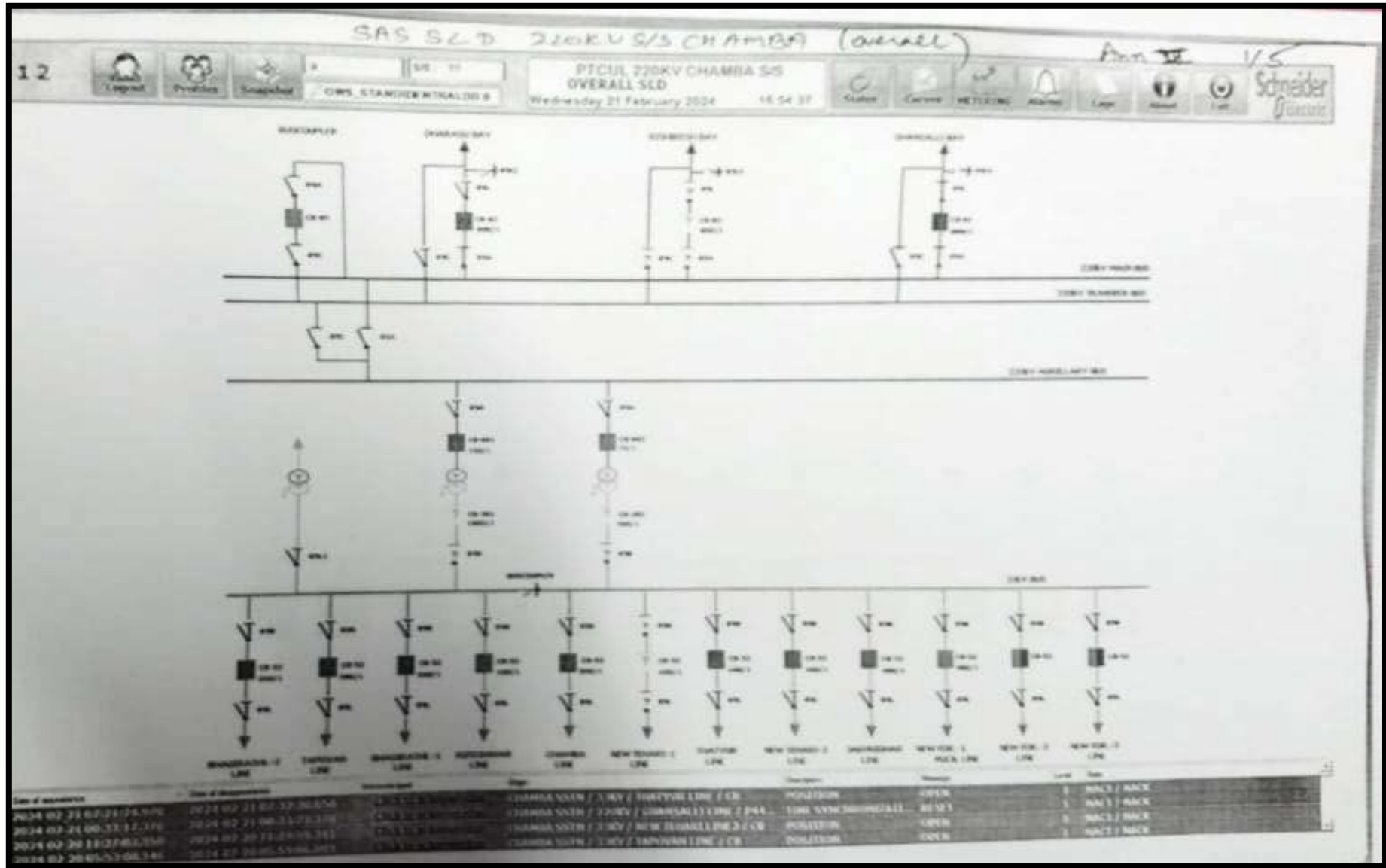

## Transmission Lines

220kV:

Particulars		Tr Line 1	Tr Line 2	Tr Line 3
Name of Tr Line		BHP	Dharashu	Rishikesh
Length of Line		55.00 km	37.90 km	40.00km
Series Compensated (Yes/No)		No	No	No
Connected to dedicated CT core (mention name)		Core1 –main 1 Core-2 main II	Core1 –main 1 Core- 2 main II	Core1 –main 1 Core-2 Backup Dir. O/C & E/F
CT Ratio		800/1	800/1	800/1
Connected to dedicated PT core (mention name)		Core1-Main1 Core2-Main 2	Core1-Main1 Core2- Main 2	Core1-Main1 Core2-Backup
PT Ratio		220 KV /110V	220 KV /110V	220 KV /110V
Relay connected to Trip Coil-1 or 2 or both		Both	Both	Both
Feed from DC supply-1 or 2		Both	Both	Both
i	Main-I Protection (Make and Model)	Gee Multilin D-60	Siemens 7SA52	Micom P44
	Functional (Yes/No)	Yes	Yes	Yes
	Date of testing	08/02/2023	19/10/2023	30/10/2023

Particulars		Tr Line 1	Tr Line 2	Tr Line 3
ii	Main-II Protection (Make and Model)	Micom P442	Siemens 7SA612	Siemens 7SJ62
	Functional (Yes/No)	Yes	Yes	Yes
	Date of testing	08/02/2023	19/10/2023	30/10/2023
iii	LBB Protection (Make and Model)	Not available	Not available	Not available
	Functional (Yes/No)	No	No	No
	Date of testing	NA	NA	NA
iv	PLCC/ Protection coupler (Make and Model)	NA	NA	NA
	Functional (Yes/No)	No		
v	DR (Make &Model) (Make and Model)	NA	NA	NA
	Functional (Yes/No)	No	No	No
vi	Time Synch.Unit (Make and Model)	SANDS	SANDS	SANDS
	Functional (Yes/No)	Yes	Yes	Yes
	Other Protections			
1	Status of Power Swing	Enable	Enable	Enable
2	Out of Step	Enable	Enable	Enable
3	SOTF	Enable	Enable	Enable
4	Breaker Failure	NA	NA	NA



Particulars		Tr Line 1	Tr Line 2	Tr Line 3
5	Broken Conductor	Alarm	Alarm	Alarm
6	STUB	NA	NA	NA
7	Fault Locator	Enable	Enable	Enable
8	Disturbance Recorder	Enable	Enable	Enable
9	VT fuse fail	Enable	Enable	Enable
10	Overvoltage Protection	NA	NA	NA
11	Trip Circuit supervision	Enable stand alone relay	Enable stand alone relay	Enable stand alone relay
12	Auto-reclose	Enable	Enable	Enable
13	Load encroachment	NA	NA	NA

## Bus-Bar Protection

220kV

Sl. No.	Particulars	Observations
a	Busbar and redundant relay make and model	Bus bar Scheme is not available at 220 KV S/S Chamba
b	Type of Busbar arrangement	NA
c	Zones	NA
d	Dedicated CT core for each busbar protection	NA
e	Breaker Failure relay included, if additional then furnish make and model	NA
f	Trip issued to both Busbar protection in case of enabling	NA
g	Isolator indication and check relays	NA
h	Other requirements for protection checking and validation	NA

## AC Auxiliary System

Sl. No.	Particulars	Observations
a	Source of AC auxiliary system	250 KVA Station transformer ( 33/0.4 KV )
b	Supply changeover between sources (Auto/Manual)	Maual
c	Diesel generator (DG) details	15 KVA (14.3HP) Gentek Power ( Sonalika)
d	Maintenance plan and supply changeover periodicity in DG	DG set manually operated & checked once in a month
e	Single Line Diagram	To be attached
f	Other requirements for protection checking and validation	NA

## DC Auxiliary System

Sl. No.	Particulars	Observations			
		110 V DC - I	110 DC - II	48 V DC-I	48 V DC-II
a	Make	Exide (UPST)	Exide	Exide	Not available
b	Model/Rating	VRLA 300AH	Lead Acid 300AH	VRLA 300AH	NA
c	Vintage	NA	NA	NA	NA
d	Measured voltage				
	i. Positive to Earth	+60V	+60V	NA	NA
	ii. Negative to Earth	-60V	-60V	48V	NA
e	No. of Cells Per Bank	55	55	24	NA
f	Availability of Battery Charger	Statcon make float:30A Boost:60A	Statcon make float:21A Boost:40A	HIRECT Make	Amar Raja Make

## Circuit Breakers

		Make and Model	No. of trip/close coil	Trip Coil Supervision relay and healthiness of coils	LBB Setting Stage 1	LBB Setting Stage 2	Remarks (If any)
<b>A</b>	<b>220kV System</b>						
<b>1</b>	C.B. 81 BHP	CGL 200SFM-40S	02 Trip/01 Close coil	Healthy	NA	NA	NA
<b>2</b>	C.B. 82 Dharashu	ABB, ELF SL4-1	02 Trip/01 Close coil	Healthy	NA	NA	NA
<b>3</b>	C.B. 84 Rishikesh	ABB, ELF SL4-1	02 Trip/01 Close coil	Healthy	NA	NA	NA
<b>4</b>	C.B. 85 Bus Coupler	CGL 200SFM-40S	02 Trip/01 Close coil	Healthy	NA	NA	NA
<b>5</b>	50 MVA 220/33KV T/F	Siemens 3AP/F1	02 Trip/01 Close coil	Healthy	NA	NA	NA
<b>6</b>	25 MVA 220/33 KV T/F	Alstom GL314	02 Trip/01 Close coil	Healthy	NA	NA	NA

## Current Transformer

<b>a</b>	<b>Location of CT</b>	<b>220 KV Chamba-BHP C.B. 81</b>				
<b>b</b>	Date of CT ratio Test Testing					
		Core I	Core II	Core III	Core IV	Core V
<b>c</b>	Accuracy Class	P.S.	P.S.	0.2	P.S.	P.S.
<b>d</b>	Purpose	Main 1 prot.	Main II prot.	Metering	Not in use	Not in use
<b>e</b>	Test Results					
<b>i</b>	Ratio Adopted	800/1	800/1	800/1	NA	NA
<b>ii</b>	Ratio measured	NA	NA	NA	NA	NA

<b>a</b>	<b>Location of CT</b>	<b>220 KV Chamba-Dharashu C.B. 82</b>				
<b>b</b>	Date of CT ratio Test Testing					
		Core I	Core II	Core III	Core IV	Core V
<b>c</b>	Accuracy Class	P.S.	P.S.	P.S.	P.S.	0.2
<b>d</b>	Purpose	Main 1 prot.	Main II prot.	Not in use	Not in use	Metering
<b>e</b>	Test Results					
<b>i</b>	Ratio Adopted	800/1	800/1	NA	NA	800/1
<b>ii</b>	Ratio measured	NA	NA	NA	NA	NA

<b>a</b>	<b>Location of CT</b>	<b>220 KV Chamba-Rishikesh C.B. 84</b>				
<b>b</b>	Date of CT ratio Test Testing					
		Core I	Core II	Core III	Core IV	Core V
<b>c</b>	Accuracy Class	P.S.	P.S.	P.S.	P.S.	0.2
<b>d</b>	Purpose	Main 1 prot.	Main II prot.	Not in use	Not in use	Metering
<b>e</b>	Test Results					
<b>i</b>	Ratio Adopted	800/1	800/1	NA	NA	800/1
<b>ii</b>	Ratio measured	NA	NA	NA	NA	NA

<b>a</b>	<b>Location of CT</b>	<b>220 KV (50 MVA T/F H.V.) C.B.881</b>				
<b>b</b>	Date of CT ratio Test Testing					
		Core I	Core II	Core III	Core IV	Core V
<b>c</b>	Accuracy Class	PS	PS	0.2	PS	PS
<b>d</b>	Purpose	Diff. Prot.	Backup O/C & E/F	0.2	Not in use	Not in used
<b>e</b>	Test Results					
<b>i</b>	Ratio Adopted	150/1	150/1	150/1	NA	NA
<b>ii</b>	Ratio measured	NA	NA	NA	NA	NA

<b>a</b>	<b>Location of CT</b>	<b>220 KV (25 MVA T/F ) C.B. 882</b>				
<b>b</b>	Date of CT ratio Test Testing					
		Core I	Core II	Core III	Core IV	Core V
<b>c</b>	Accuracy Class	PS	PS	0.2	PS	PS
<b>d</b>	Purpose	Diff. Prot.	Backup O/C & E/F	0.2	Not in use	Not in used
<b>e</b>	Test Results					
<b>i</b>	Ratio Adopted	75/1	75/1	75/1	NA	NA
<b>ii</b>	Ratio measured	NA	NA	NA	NA	NA



## Capacitive Voltage Transformer/Potential Transformer

<b>a</b>	<b>Location of CVT/PT</b>	<b>C.B. 81 Chamba-BHP</b>		
<b>b</b>	Date of CT/PT ratio Test Testing			
		Core I	Core II	Core III
<b>c</b>	Accuracy Class	3P	3P	0.2
<b>d</b>	Purpose	Main 1 Prot.	Main II Prot.	Metering
<b>e</b>	Test Results			
<b>i</b>	Ratio Adopted	220 KV/110V	220 KV/110V	220 KV/110V
<b>ii</b>	Ratio measured	NA	NA	NA

<b>a</b>	<b>Location of CVT/PT</b>	<b>C.B. 82 Chamba-Dharashu</b>		
<b>b</b>	Date of CT/PT ratio Test Testing			
		Core I	Core II	Core III
<b>c</b>	Accuracy Class	3P	3P	0.2
<b>d</b>	Purpose	Main 1 Prot.	Main II Prot.	Metering
<b>e</b>	Test Results			
<b>i</b>	Ratio Adopted	220 KV/110V	220 KV/110V	220 KV/110V
<b>ii</b>	Ratio measured	NA	NA	NA

<b>a</b>	<b>Location of CVT/PT</b>	<b>C.B. 84 Chamba-Rishikesh</b>		
<b>b</b>	Date of CT/PT ratio Test Testing			
		Core I	Core II	Core III
<b>c</b>	Accuracy Class	3P	3P	0.2
<b>d</b>	Purpose	Main 1 Prot.	Main II Prot.	Metering
<b>e</b>	Test Results			
<b>i</b>	Ratio Adopted	220 KV/110V	220 KV/110V	220 KV/110V
<b>ii</b>	Ratio measured	NA	NA	NA

<b>a</b>	<b>Location of CVT/PT</b>	<b>220 KV Bus CVT</b>		
<b>b</b>	Date of CT/PT ratio Test Testing			
		Core I	Core II	Core III
<b>c</b>	Accuracy Class	3P	3P	0.2
<b>d</b>	Purpose	HV O/C & E/F prot..	NA	Metering
<b>e</b>	Test Results			
<b>i</b>	Ratio Adopted	220 KV/110V	NA	220 KV/110V
<b>ii</b>	Ratio measured	NA	NA	NA

## Disturbance Recorder (DR) & Event Logger (EL)

Sl. No.	Particulars	220kV
1	a) Is the Disturbance recorder and Fault locator provided on all line feeders?	Yes
	b) Whether standalone or built in Main relay	Built In
	c) Whether DR is having automatic fault record download facility to a central PC	SAS engineering Workstation PC
	d) Whether Central PC for DR, EL are powered by Inverter (fed from station DC)	UPS
2	Whether substation is having Event logger facility	Yes
	If Yes (standalone or built-in-SAS)	Built In
3	Whether GPS based time synchronizing equipment is provided at the substation for time synchronizing of Main relays / DR/ Event logger / SAS/ PMU / Line Current Differential Relays	Yes (SAS GPS)

## Communication System

Sl. No.	Name of Line Feeder	PLCC/OPGW /none	If PLCC for protection(y/n )	Coupling type & no. Of channel	If opgw for protection( y/n)	Geographicall y distributed for main-1 & main-2 dedicated/mul tiplexed
1	220 KV Chamba- BHP Line ( C.B. 81)	PLCC	Yes	Ph-Ph	No	Not Dedicated
2	220 KV Chamba-Dharshu Line (C.B.82)	PLCC	No	Ph-Ph	no	NA
3	220 KV Chamba- Rishikesh Line (C.B.84)	PLCC	No	Ph-Ph	no	NA

## Transformer Protection

Particulars	TF-1	TF-2
<b>Name of ICT</b>	220/33KV 50 MVA T/F	220/33 KV 25MVA T/F
<b>Make</b>		
<b>Connected to dedicated CT core (HV Bay)</b>		
<b>Core-1</b>	Differential Prot.	Differential Prot.
<b>Core-2</b>	O/C & E/F Prot.	O/C & E/F Prot.
<b>Core-3</b>	Metering	Metering
<b>Core-4</b>	Not in use	Not in use
<b>Core-5</b>	Not in use	Not in use
<b>CT ratio</b>	150/1	75/1
<b>Connected to dedicated Bus CVT core (HV Bay)</b>		
<b>Core-1</b>	HV O/C & E/F	HV O/C & E/F
<b>Core-2</b>	NA	NA
<b>Core-3</b>	Metering	Metering
<b>CVT ratio</b>	220 KV/110V	220 KV/110V
<b>Relay connected to Trip Coil-1 or 2 or both (HV)</b>	Both	Both
<b>Feed from DC supply-1 or 2(LV)</b>	DC Supply-1	DC Supply-1
<b>Connected to dedicated CT core (LV Bay)33 KV</b>		
<b>Core-1</b>	Differential Prot.	Differential Prot.
<b>Core-2</b>	O/C & E/F Prot.	O/C & E/F Prot.

Particulars		TF-1	TF-2
Core-3		Metering	Metering
Core-4		Not in use	Not in use
Core-5		Not in use	Not in use
CT ratio		1000/1	500/1
<b>Connected to dedicated Bus CVT core (LV Bay)</b>			
Core-1		NA	NA
Core-2		NA	NA
Core-3		NA	NA
CVT ratio		NA	NA
Relay connected to Trip Coil-1 or 2 or both (HV)		NA	NA
Feed from DC supply-1 or 2(LV)		NA	NA
LA Rating/ HV Side		NA	NA
LA Rating/ LV Side		NA	NA
Date of last testing of Protection		NA	NA
<b>Group A Protection</b>			
1	Differential Protection (Make & Model)	Schneider Micom P643	Easun Reyrole Duobias-M
2	PRV	Ok	OK
3	WTI Indication working	OK	OK
4	Back-up Over Current Protection HV (Make & Model)	Schneider P143	Argus-Reyrole
5	Over Flux Protection (Make & Model) HV	Feature used in Differential Relay	No

Particulars		TF-1	TF-2
<b>Group B Protection</b>			
1	REF Protection (Make & Model)	E.E. Inst. E/F	E.E. Inst. E/F
2	Bucholtz	Ok	Ok
3	Back-up Over Current Protection LV (Make & Model)	Shneider P143	Argus-Reyrole
4	Over Flux Protection (Make & Model) LV	NA	NA
5	OTI Indication working	ok	ok

# Network Diagram of Uttarakhand

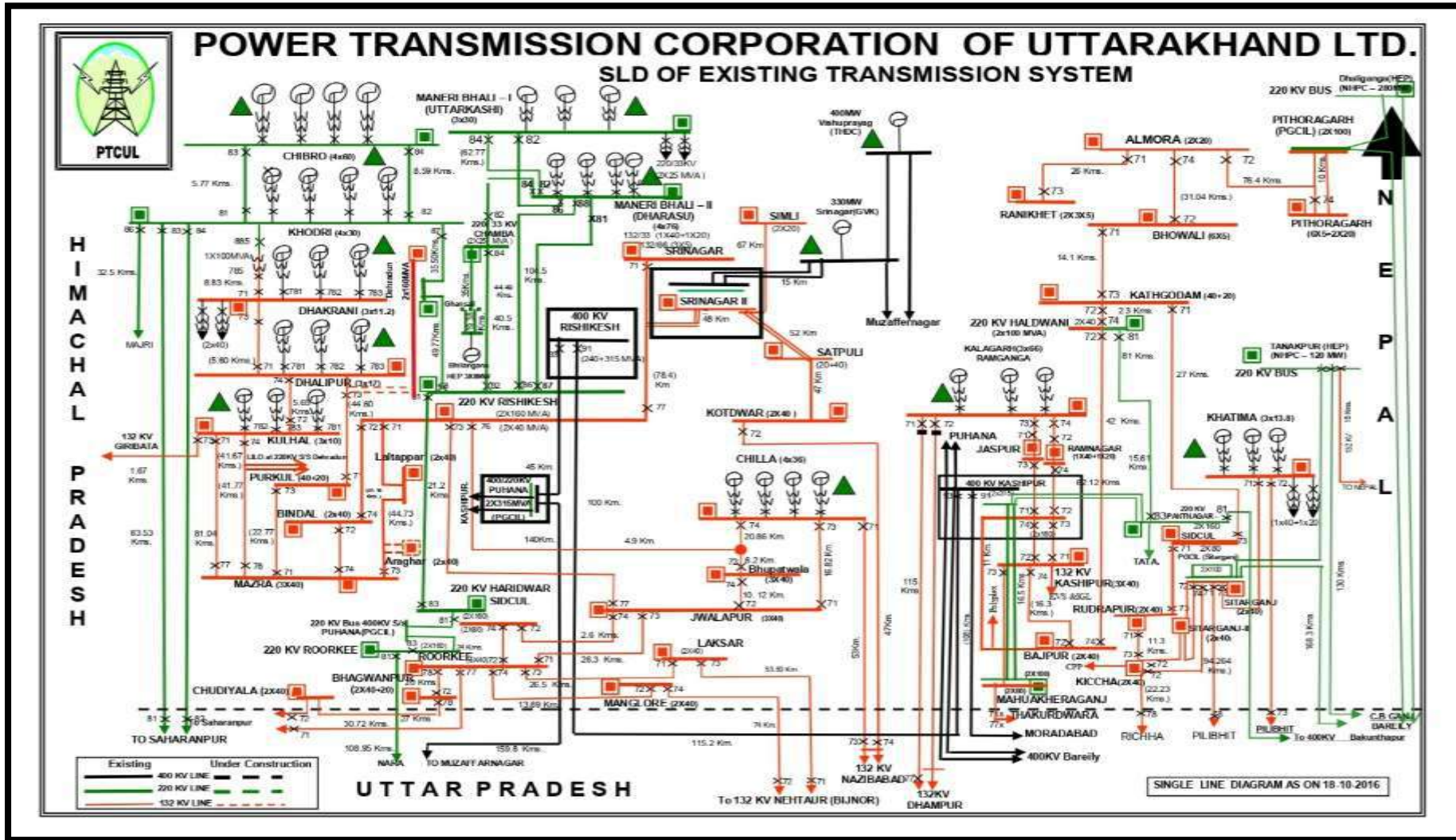



# Power Map of Uttarakhand

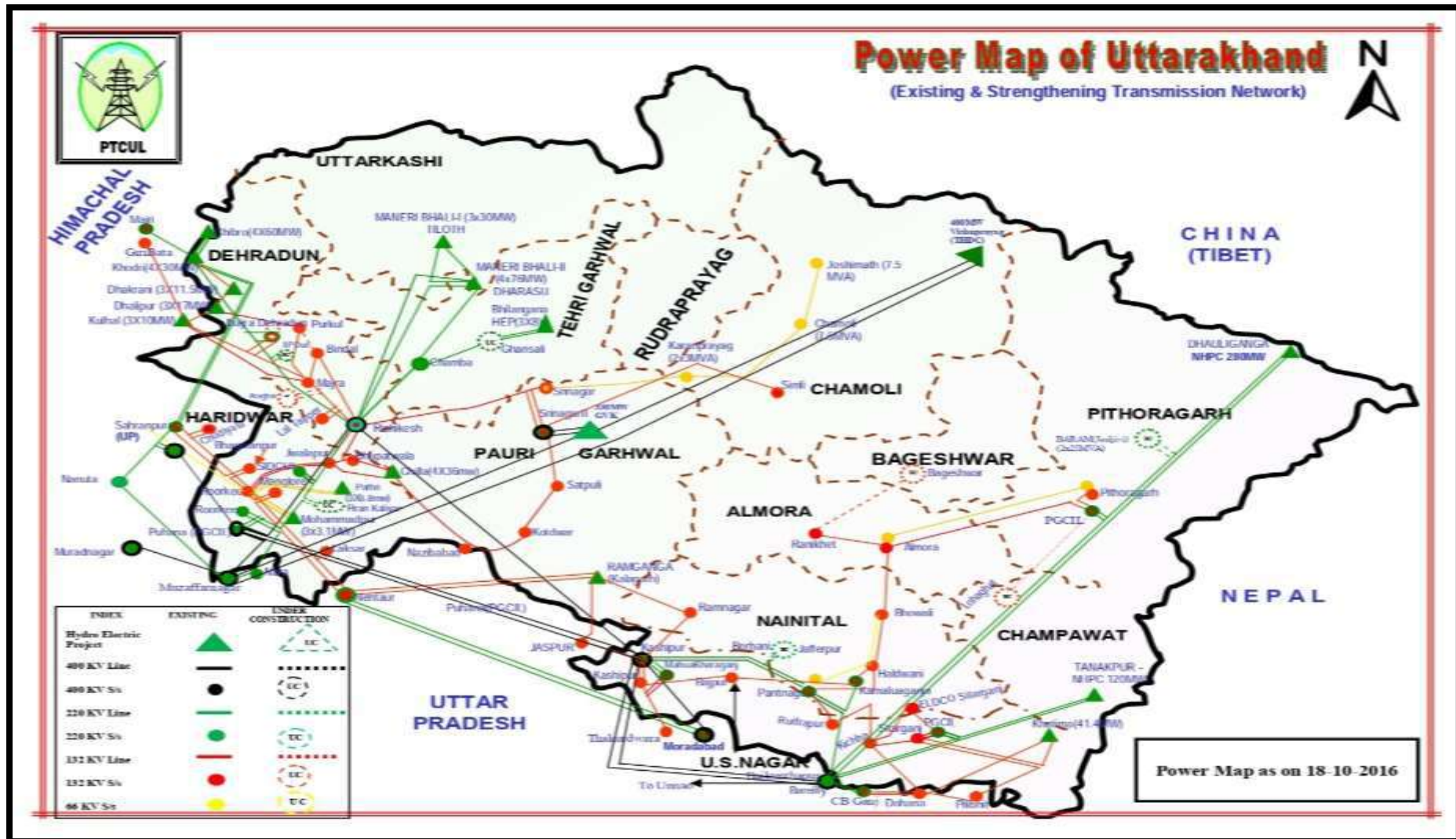



# **Power Transmission Corporation of Uttarakhand Limited**

(A Govt. of Uttarakhand Undertaking)

Corporate ID No.: U40101UR2004SGC028675

## **FINAL REPORT**

### **Protection Audit**

**220/132KV SIDCUL Haridwar Substation**

**Submitted**

**By**



**CENTRAL BOARD OF IRRIGATION & POWER**

**NEW DELHI**



# केन्द्रीय सिंचाई व शक्ति मंडल CENTRAL BOARD OF IRRIGATION AND POWER

25<sup>th</sup> June 2024

Order No.: 376/SE (T&C)/PTCUL/(H). dated: 29.09.2023

## Protection Audit Report

FINAL PROTECTION AUDIT REPORT OF 220/132KV SIDCUL HARIDWAR SUB-STATION UNDER POWER TRANSMISSION CORPORATION OF UTTARAKHAND LIMITED (PTCUL), UTTARAKHAND.

Submitted  
To



**Power Transmission Corporation of Uttarakhand Limited**

(A Govt. of Uttarakhand Undertaking)

Corporate ID No.: U40101UR2004SGC028675

## Contents

<b>Disclaimer</b> .....	6
<b>1.0. Executive Summary</b> .....	7
<b>2.0. Introduction</b> .....	10
2.1. <i>Background</i> .....	10
2.2. <i>Scope of Work</i> .....	10
2.3. <i>Audit Rationale</i> .....	11
2.4. <i>Audit Process</i> .....	12
2.5. <i>About Power Transmission Corporation of Uttarakhand (PTCUL)</i> .....	14
2.6. <i>About Central Board of Irrigation &amp; Power (CBIP)</i> .....	15
<b>3.0. Preliminary Audit of 220/132/33 kV SIDCUL Haridwar Substation</b> .....	16
3.1. <i>General Information about Substation</i> .....	16
3.2. <i>Audit Team</i> .....	16
3.3. <i>Recommendation of last protection checking and validation</i> .....	17
3.4. <i>Review of existing settings at substation</i> .....	18
3.5. <i>Disturbance Recorder availability for the last 6 tripping's</i> .....	18
3.6. <i>Chronic reason of tripping, if any</i> .....	19
3.7. <i>Major non-conformity/deficiency observed</i> .....	19
<b>4.0. List of Trippings</b> .....	20
<b>5.0. Observations and Recommendations</b> .....	25
5.1. <i>Reporting of all the Tripping with DR/EL</i> .....	25
5.2. <i>Development of centralized database of relay settings</i> .....	25
5.3. <i>Review of test results of relay and equipment</i> .....	26
5.4. <i>Availability of Testing Kits</i> .....	26
5.5. <i>Up-dation of PTCUL Protection Philosophy</i> .....	26
5.6. <i>Simulation based study of protection system</i> .....	27
5.7. <i>Capacity Building of protection team</i> .....	27
5.8. <i>Updated Fault Level/ Short Circuit Level and Network information</i> .....	27
5.9. <i>General Protection related observations</i> .....	27
5.10. <i>O&amp;M Manual</i> .....	27
<b>6.0. Station Specific Observation and Recommendations</b> .....	28
6.1. <i>Protection related observations and recommendations</i> .....	28
6.2. <i>Equipment related observations and recommendations</i> .....	28
6.3. <i>Auxiliary Equipment related observations and recommendations</i> .....	29
<b>Annexure – 1: Suggested List of Testing Instruments</b> .....	30
<b>Annexure – 2: Suggested List of Substation Equipments</b> .....	31
<b>Annexure – 3: Suggested List of Maintenance Equipments</b> .....	32

**Annexure – 4: Protection Code (IEGC 2023 Chapter 4).....33**  
**Annexure – 5: Third Party Protection System Checking & Validation Template for a  
Substation (IEGC 2023 Annexure – 1).....38**  
**Annexure – 6: Protection Philosophy/Protocol of Northern Region .....43**  
**Annexure – 7: Work Order & Corrigendum.....49**  
**Annexure – 8: Data Sheets .....57**

## ACRONYMS

<b>A</b>	Ampere
<b>AC</b>	Alternating Current
<b>AMP</b>	Annual Maintenance Plan
<b>CBIP</b>	Central Board of Irrigation and Power
<b>CT</b>	Current Transformer
<b>CVT</b>	Capacitive Voltage Transformer
<b>DC</b>	Direct Current
<b>DG</b>	Diesel Generator
<b>DPR</b>	Detailed Project Report
<b>DR</b>	Disturbance Recorder
<b>EL</b>	Event Logger
<b>EMTP</b>	Electromagnetic Transient Program
<b>EE</b>	Executive Engineer
<b>GPS</b>	Global Positioning System
<b>ICT</b>	Inter Connecting Transformer
<b>IEGC</b>	Indian Electricity Grid Code
<b>JE</b>	Junior Engineer
<b>KA</b>	Kilo Ampere
<b>KV</b>	Kilo Volt
<b>LBB</b>	Local Breaker Backup
<b>LEFT</b>	Earth Fault
<b>MVA</b>	Mega Volt Ampere
<b>NA</b>	Not Available
<b>NRPC</b>	Northern Regional Power Committee
<b>O&amp;M</b>	Operation & Maintenance
<b>OCC</b>	Operation Coordination Sub Committee

<b>PLCC</b>	Power Line Carrier Communication
<b>PSC</b>	Power System Sub Committee
<b>PSDF</b>	Power System Development Fund
<b>PT</b>	Potential Transformer
<b>PTCUL</b>	Power Transmission Corporation of Uttarakhand Limited.
<b>RLDC</b>	Regional Load Dispatch Centre
<b>RPC</b>	Regional Power Committee
<b>SAS</b>	Substation Automation System
<b>SE</b>	Superintendent Engineer
<b>SCADA</b>	Supervisory Control & Data Acquisition
<b>SLD</b>	Single Line Diagram
<b>SLDC</b>	State Load Dispatch Centre
<b>SOTF</b>	Switch On-To Fault
<b>SPS</b>	Special Protection Scheme
<b>T&amp;C</b>	Testing & Commissioning
<b>UJVNL</b>	Uttarakhand Jal Vidyut Nigam Ltd
<b>UPCL</b>	Uttarakhand Power Corporation Ltd
<b>WTI</b>	Winding Temperature Indicator

## Disclaimer

The protection audit has been carried out based on the guidelines provided under various documents mentioned in the report. For the purpose of audit, the auditor(s) have relied upon the data made available by the client and information & clarifications made available, in the written or verbal form, by the officials of clients during site visit and later.

The report is not for public distribution and has been furnished solely for information and must not be reproduced or redistributed to others, except those concerned. No one can use the report as a base for any claim, demand or cause of action and, also no one is responsible for any loss incurred based upon the content of this report.

While every effort is made to ensure the accuracy and completeness of information contained, CBIP takes no responsibility and assumes no liability for any error/ omission or accuracy of the information. Recipients of this material should rely on their own judgments and conclusions from relevant sources before taking any decision.



## 1.0. Executive Summary

PTCUL awarded the work of Third-Party Protection Audit of 2 nos. 400kV and 8 nos. 220kV substations of PTCUL (“Utility”) to CBIP. CBIP planned the audit as per Audit process provided under Protection Code within Indian Electricity Grid Code 2023. In addition, the guidelines of Ramakrishna Committee for checking and validation and NRPC guidelines for Third Party Audit were also adhered to. The CBIP manual on protection (manual no 247-Revised), NRPC protection philosophy were also referred to.

As a part of audit process, utility was asked to provide set of information before start of audit. Team from CBIP consisting of Mr. Vijay Barthwal, Mr. M.R. Chauhan, Mr. Avichal Pandey & Mr. Shivam Gupta visited 220/132 SIDCUL Substation during 22<sup>nd</sup> – 23<sup>rd</sup> February 2023 and preliminary audit report was submitted on the spot. The representatives of utility were present during this process. Some more information was sought from the Utility.

Based on the data made available by Utility, draft of final report was submitted to Utility and after discussions, report was finalized. The details of audit process, data made available by Utility, observations from preliminary report and detailed observations and recommendations are provided in this report. Key observations and recommendations are summarized below under 2 heads.

### **General Observations and Recommendations for Organization Level implementation**

01. It is recommended that each substation to have a central repository for tripping reports, along with Time Synchronized DR/EL reports and analysis. A dedicated PC can be provided at each substation for the purpose.
02. The protection philosophy adopted by Utility, in general, is in alignment with protection philosophy adopted by NRPC. As the NRPC has recently updated the protection philosophy, PTCUL in consultation with SLDC may update protection philosophy for network not covered by NRPC too, if needed, and implement the same.
03. It is recommended that latest recommended relay settings, as per the NRPC protocol for 220KV & above Substations, along with setting calculations & parameters used for all the relays, be kept at each substation. This will help in proper fault analysis and ascertaining relay healthiness. Similarly, Relay settings for sub-stations below 220kV, based on any such protocol by SLDC, along with setting calculations and line parameters also needs to be maintained.
04. It is recommended that the detailed reports of test results for the relays and switchyard equipments be maintained at sub-station level.

05. Based on “Draft O&M Manual” of PTCUL and discussions with their officials, a list of testing equipment is suggested and enclosed at Annexure - 1. Also, a list of switchyard maintenance equipment is placed at annexure -3. It is recommended that the necessary testing and maintenance equipment at substation/Sub-division/Division be arranged for regular testing and maintenance of equipment at substations.
06. Simulation based studies or EMTP Studies should be carried out by the Utility, as per the requirement of IEGC-2023.
07. For the protection system and SAS, PTCUL may undertake capacity building exercise for the officials involved in these activities.
08. It is recommended that the updated network information and short circuit level should be periodically reviewed and maintained at central level for revising the setting as per requirement.
09. It is suggested that utility may carry out exhaustive safety and technical audit of sub-stations apart from protection audit, either internally or thru’ third party for implementing the best practices in the sub-station.
10. It is suggested that the existing draft O&M manual be updated to take care of latest developments.

#### **Observations and Recommendations for 220/132KV SIDCUL Haridwar Substation**

01. The protection audit of this sub-station was carried out recently on 12-13 Oct 2022 by NRPC/Power Grid Corporation. The few actions are initiated and compliance is pending so far. It is recommended to take necessary action for compliance and maintain record of the same.
02. Bus Bar Protection on 220KV Bus is not functional after addition of the new elements with the 220KV bus. It is recommended to make it functional.
03. in the absence of Event Logger, SAS acts as Event logger also. After malfunctions of Contact Multiplier Relay(s) of SAS on 25<sup>th</sup> June 2023, SAS has been disabled and is not in service. It is recommended that SAS to be put back into service after detailed analysis and corrective actions.
04. 22 (Twenty-Two) nos. of Back-up protection relays are not provided with time-sync and communication ports. It is suggested that modification/upgradation be done, based on protection philosophy applicable for respective voltage level.
05. Both of the GPS time synchronisation is not functional. Recommended for early corrective action.

06. PLCC is unhealthy, therefore, tele protection is out of service for both the 220KV circuits. It is suggested to commission carrier aided protection.
07. It is suggested that possibility of extending the 220KV transfer bus to 220KV side of 220/33KV transfer needs to be explored.
08. Both the 220V DC systems are showing earth-fault. It is recommended to take corrective actions to avoid any untoward tripping.
09. Based on inputs provided by utility and analysis of data a list of suggested switchyard and maintenance equipment for replacement is provided in Annexure – 2.

## 2.0. Introduction

### 2.1. Background

The work has been awarded to the Central Board of Irrigation & Power (CBIP) vide Work Order Number: 376/SE (T&C)/PTCUL/(H), dated: 29.09.2023 for Protection Audit of 02 Nos. 400 kV and 08 Nos. 220 kV Sub-Stations at Uttarakhand, for Power Transmission Corporation of Uttarakhand Limited (PTCUL) in reference to the offer submitted by CBIP to PTCUL vide ref. no. P-1/CBIP/PTCUL/Audit/2023, dated: 11.09.2023. A Kick-Off Meeting was held between PTCUL and CBIP at the office of SE (T&C), PTCUL, Kathgodam, Haldwani on 26<sup>th</sup> October 2023. Detailed discussions were held regarding process and methodology of Execution and Submission of reports of Protection Audit. As per the above-mentioned meeting, a corrigendum was released by PTCUL vide ref. no. 394/SE (T&C)/PTCUL/(H), dated: 26.10.2023.

**As per the given order, the protection audit of following sub-stations is to be carried out:**

1. *400kV Rishikesh*
2. *400kV Kashipur*
3. *220kV Chamba*
4. *220kV Rishikesh*
5. *220kV Roorkee*
6. *220kV Haridwar (SIDCUL)*
7. *220kV Jhajra*
8. *220kV Pantnagar*
9. *220kV Haldwani*
10. *220kV Mahuakheraganj*

### 2.2. Scope of Work

Review of the implemented protection schemes/philosophy for 400/220 kV substations which includes protection of transmission lines, interconnecting transformers, line/bus reactors, bus bar, bus couplers etc. with respect to tripping in last one year as per latest guidelines of Ramakrishna committee/ CBIP/NRPC/International best practices, which includes review of the following:

- a. *Adequacy of primary and backup protection settings for protected equipment and suggest corrective measures.*
- b. *Availability/healthiness of PLCC communication links used for protection systems.*
- c. *Healthiness/adequacy of 220/110/50V DC system available at substations for protection application.*
- d. *Availability/healthiness of GPS system and time synchronization facility used for protection.*
- e. *Availability/healthiness of recording instruments like DRs /ELs for transmission lines protection.*
- f. *Test reports for assessing the healthiness of circuit breakers, CT & CVT based upon available test reports at sites.*
- g. *Field inspection of protection device for obsolescence of technology, suitability and healthiness.*
- h. *Prepare recommendation for replacement of obsolescence relays with compatible numerical relays will be provided.*
- i. *Checking of availability of DG Set / auxiliary DC supply at substations.*

### **2.3. Audit Rationale**

- a. PTCUL (Utility) has submitted a DPR for Replacement of certain equipment under PSDF scheme to Grid-India. Grid-India has asked PTCUL to carry out protection audit of certain substations.
- b. In addition, as per CERC IEGC 2023 Chapter-04 (Protection Code) Para - 15 (2) “All users shall also conduct third party protection audit of each substation at 220KV and above (132KV and above in NER) once in 5 years or earlier as advised by the respective RPC”.
- c. As per Para – 15 (4) of said Code, “The third-party protection audit report shall contain information sought in the format enclosed as Annexure–1. The protection audit reports, along with action plan for rectification of deficiencies detected, if any, shall be submitted to the respective RPC and RLDC or SLDC, as the case may be, within a month of submission of third-party audit report. The necessary compliance to such protection audit report shall be followed up regularly in the respective RPC”.
- d. Subsequently NRPC issued protection philosophy for Northern region developed in compliance of IEGC 2023, Version 2.0 which was approved in 71<sup>st</sup> NRPC meeting held on 29.01.2024. Accordingly, protection audit of 220KV and above Substations is being carried out by CBIP, as per Annexure -1 of IEGC-2023.

## 2.4. Audit Process

- PTCUL shall provide the following documents:
  - a. The Network Diagram, covering the relevant assets
  - b. Latest relay settings adopted and calculations for respective sub-stations and transmission lines.
  - c. Annual maintenance plan (AMP), including the schedule and activities covered under AMP
  - d. Any specific issues covered under OCC and/or PSC of NRPC for relevant assets.
- For each sub-station, check-list shall be provided by PTCUL. During field visit, the information shall be verified.
- The minimum set of points on which checking and validation shall be carried out is provided as per annexure - 4 for the following available power system elements at station, as per attached formats:

Sl. No.	Elements
1	Transmission Line
2	Bus Reactor/Line Reactor
3	Inter-connecting Transformer
4	Busbar
5	AC auxiliary system
6	DC auxiliary system
7	Communication system
8	Circuit Breaker Details
9	Current Transformer Details
10	Capacitive Voltage Transformers Details
11	Any other equipment/system relevant for protection system operation

- During field visit, no testing of equipment and relay shall be carried out. The visual inspection, operational log shall be considered for audit purpose, apart from the documents provided by PTCUL

- A calibrated multi-meter shall be provided at sub-station for checking AC and DC voltages and currents online, wherever feasible, without impacting the sub-station operations.
- The preliminary report shall be prepared on the site and shall be signed by all the parties present, as given below:

S. No.	Issues	Remarks
1	Recommendation of last protection checking and validation	Status of works and pending issues if any
2	Review of existing settings at substation	Recommended Action
3	Disturbance Recorder out/ available for last 6 tripping's (Y/N)	Recommended Action
4	Chronic reason of tripping, if any	Recommended Action
5	Major non-conformity/deficiency observed	Recommended Action

- **The Final summary shall specifically mention minimum following points:**
  - The settings and scheme adopted are in line with agreed protection philosophy or any accepted guidelines (e.g., Ramakrishna guidelines or CBIP manual based).
  - The deviations from the RPC protection philosophy, if any and reasons for taking the deviations shall be recorded.
  - All the major general deficiency shall be listed in detail along with remedial recommendations.
  - The cases of protection maloperation (last 1 year) shall be analysed from tripping reports and the causes of failure along with corrective actions and recommendations based on the findings.

## *2.5. About Power Transmission Corporation of Uttarakhand (PTCUL)*

The State of Uttarakhand's power transmission utility, PTCUL, was formerly known as Uttaranchal. According to the Uttar Pradesh State Reorganization Act 2000, this 27<sup>th</sup> state of the republic of India was formed on November 9, 2000, by dividing the Himalayan and surrounding North-Western districts of Uttar Pradesh.

The State of Uttaranchal in exercise of the power granted to it under section 63(4) of the State Re-Organization Act, 2000, formed two separate companies in power sector:

- Uttaranchal Jal Vidyut Nigam Ltd. (UJVNL) – For generation of Hydro-Electricity in the State.
- Uttaranchal Power Corporation Ltd. (UPCL) – For Transmission and Distribution of Electricity in the state.

Enactment of the Electricity Act 2003, a distinct watershed in the Indian Power Sector, made it mandatory for all the States to restructure their SEBs. As per the provisions of Electricity Act 2003, the State Government separated power transmission business from UPCL which was left only with distribution of electricity.

In order to manage Power Transmission Operations, a new company called Power Transmission Corporation of Uttaranchal Ltd. was established. On 27<sup>th</sup> May, 2004, the firm was formed as a Government Company in accordance with section 617 of the Companies Act, 1956. It began operating from 1<sup>st</sup> June, 2004.

The company's corporate and registered office is located in Vidyut Bhawan, Saharanpur Road, Majra, Dehradun, next to the ISBT Crossing.



## *2.6. About Central Board of Irrigation & Power (CBIP)*

The Government of India established the Central Board of Irrigation and Power in 1927, making it a Premier Institution. For the past 93 years, CBIP has provided committed services to the nation's professional associations, engineers, and individuals involved in the power, water resources, and renewable energy sectors. While serving the country equally and to great honour, CBIP has developed into an esteemed institution of international significance. CBIP is Indian chapter for 10 international organizations related to Power & Water resources sectors.

CBIP is involved in executing various activities such as, International Conferences, Technical Documents Publications, Training Activities, Research & Development, Consultancy Services including Technical, Protection & Safety Audits.

## 3.0. Preliminary Audit of 220/132/33 kV SIDCUL Haridwar Substation

### 3.1. General Information about Substation

Sl. No.	Particulars	Details
1	Substation Name	220/132/33 kV SIDCUL Haridwar Substation
2	Name of Owner Utility	Power Transmission Corporation of Uttarakhand Limited (PTCUL)
3	Voltage Level (s) or highest voltage level	220/132/33KV
4	Short circuit current rating of all equipment (for all voltage level)	220KV = 50KA/sec, 132KV = 40KA/sec 33KV = 25KA/sec
5	Date of commissioning of the substation	6 <sup>th</sup> November 2006
6	Checking and validation date	22 <sup>nd</sup> – 23 <sup>rd</sup> February 2024

### 3.2. Audit Team

#### Audit Team (CBIP):

- Mr. Vijay Barthwal
- Mr. M.R. Chauhan
- Mr. Shivam Gupta
- Mr. Avichal Pandey

#### PTCUL Representative:

- Er. Ashwini Kumar, Executive Engineer (T&C)
- Er. Vipin Kumar, Executive Engineer (O&M)
- Er. Virendra Singh Mehra, Assistant Engineer (T&C)
- Er. Amrish Kumar, Assistant Engineer (O&M)

### 3.3.Recommendation of last protection checking and validation

Last Protection Audit was carried out on 12<sup>th</sup> and 13<sup>th</sup> October 2022.

Following observation were recorded:

Deficiencies/Non conformity observed in last Protection Audit	Compliance Status
<p>Only one distance protection relay (Main-1) is available on both 220kV feeders. It is recommended to install main-2 relay for the backup of Main-1 distance protection.</p>	<p>To be analyzed and implemented based on new guidelines from NRPC</p>
<p>DEF (67N) function although available in main-1 relays yet it is disabled. As per Model Relay Setting Guidelines, it is recommended to enable 67N in both Main-1 &amp; Main-2 relays. However, separate Over current and earth fault relay is provided in place of Main-2</p>	
<p>There is no separate relay for over voltage protection. Overvoltage function in distance relay is disable in both the lines. As per guideline relay settings two stage overvoltage protection shall be provided. Low set stage (Stage-I) may be set in the range of 110% - 112% (typically 110%) with a time delay of 5 seconds. High set stage (Stage-II) may be set in the range 140% - 150% with a time delay of 100milliseconds.</p>	
<p>It is observed that only single stage CBF protection is used for tripping of boundary breakers. As per model relay setting guidelines it is recommended to provide two stage CBF protection first for re tripping own CB and second for boundary CBs.</p>	
<p>It is found that reverse zone reach setting for Rishikesh line is 12.5% of zone 1 reaching M1 distance relay and Piran Kaliyar is 20% of zone 1 reach. As per NRPC protection philosophy setting the Reverse zone shall be 25% of the zone-1 reach with time setting of 1s. The same may be checked.</p>	
<p>Busbar protection is out of service. Presently there is no protection available for busbar protection. It is recommended to replaced old busbar protection with numerical relays.</p>	<p>No changes observed</p>
<p>Fire protection system for 50MVA transformer is out of service. Recommended to rectify the fire protection system and put in service.</p>	

Deficiencies/Non conformity observed in last Protection Audit	Compliance Status
Both 220V DC battery bank has -ve earthed, need to rectify. One 50V Battery bank and Chargers not in service.	
Earth Leakage Relay in DCDC-1 not in service. In 50V system earth leakage relay not available.	
Earth Fault observed in both the DC sources at charger end. DC voltage from positive to earth at source-1 & 2 is observed to be inadvertently high for 220V DC system.	
Two sources of LVAC supply are available via 33kV/415V substation transformer for the auxiliary load consumption in the substation.	For information only
DG kept in manual mode	
No record of Circuit Breaker testing available.	
No record of CVT testing available.	
SAS and DR available but not in service. At present there is no system for the event log and DR extract DR from the relay.	
PLCC not used for tele protection.	

### *3.4. Review of existing settings at substation*

- a. Utility has provided relay settings adopted for various feeders and transformers.
- b. The record of different relay setting calculations is not available at the substation level.
- c. All relays are numeric, therefore, as per internal protocol of utility relays are tested only at the time of commissioning/change in setting. Copy of test reports not available at substation level.
- d. Based on the Protection Audit held on 12<sup>th</sup> and 13<sup>th</sup> October 2022, the Utility is in the process of up-dation relay settings as per the recommendations.

### *3.5. Disturbance Recorder availability for the last 6 tripping's*

- a. For transformers and Intra-state lines DR data is taken at station level for analysis purpose from individual relays. No centralised record of such data is kept at Substation level.

### ***3.6. Chronic reason of tripping, if any***

- a. On 25<sup>th</sup> June 2023 in SIDCUL, Haridwar S/S, SAS CMR relay malfunction observed at 7:00 hrs, 7:43 hrs and 19:50 hrs for 160MVA Transformer, 50MVA Transformer and 160MVA Transformer respectively.

### ***3.7. Major non-conformity/deficiency observed***

- a. The status of previous Audit report and its compliance is provided in previous paragraphs.
- b. Bus Bar Protection on 220kV Bus is not functional, after addition of new elements in the 220 kV Bus.
- c. No provision for Bus Bar Protection is available at 132kV level.
- d. Both the 220/33 KV T/Fs cannot be connected through TBC as Transfer Bus arrangement was not extended for these two T/Fs.
- e. After malfunctions of SAS on 25<sup>th</sup> June 2023, SAS has been disabled and is not in service
- f. Two nos. of GPS Time Sync are provided one for SAS and other caters for relays and other equipments of S/S. Both GPS are not functional.
- g. Following 22 No(s) numerical relays are not provided with Time Sync Input and Communication Port. These relays are been used as backup relays-

<b>Relay</b>	<b>No(s)</b>
P127	11
P821	2
P122	9

- h. Both the 220V DC systems are showing earth-fault.
- i. PLCC is unhealthy and therefore tele protection is out of service.
- j. Only one set of 48 V DC system is available.
- k. The events are recorded from individual relays, no separate Event Logger is provided.
- l. Recommended relay settings with supporting calculations/ parameters needs to be kept at S/S level.
- m. All the isolators are operated manually. The AC and DC system needs to be checked during maintenance to avoid earth faults in auxiliary system.
- n. The record for equipment testing is not been maintained at S/S level.

## 4.0. List of Trippings

Name of Feeder/TF & CB No.	Type of Relay / Scheme	Date&Time of Tripping	Date& Time of closing	flags observed	Other end flage	affected generation/ load	Tripping Analysis / Action taken report	Category Code	Action Taken
160 MVA 1 CB- 881/781	Areva	16.08 hrs 18.04.2023	17.09 hrs 18.04.2023	CP- OTI/WTI temp RP- I> phase ABC trip,Trip Relay 86D, Trip relay 86M		nil	WTI meter found faulty	LHWT	Informed to O&M wing for required action
132KV CB NO 74	Micom	18-05- 2023/2:11	18-05- 2023/3:12	CP-O/CTRI P EF RELAY OPTD RP- TRIP 50/51 TRIP, NAF, Ia=0.92, Ib= 0 ,Ic==0	CP- DIST PROTN OPTD ,DIST PROTN START, MTR OPTD RP-DIST PROTN RELAY LED 1,2,5,9 DIST=3.9KM,D IST PICKUP L1E	nil	Due to bad weather	TLF	Informed to O&M wing for required action
CB NO.78 (SIDCUL- JWAPUR)	MICOM	25.06.23 06:53	25:06:23 14:28	CP-BREAKER PD TRIP BREAKER AUTO TRIP BREAKER TROUBLE BREAKER FAIL 30X PLCC CHANNEL FAIL OUT BREAKER FAULT 30X RP-MULTIPLIER TO 21M1 21M1X MUX86B TRIP RELAY 86B	NA	NIL	Breaker fault	SEMT	Informed to O&M wing for required action
CB NO.881/7 81 160MVA T/F 1	AREVA	25.06.23 07:00	25:06:23 11:23	CP-881- BREAKER PD TRIP BREAKER AUTO TRIP T/F TROUBLE ALAR, BREAKER TROUBLE RP-TRIP RELAY 86B/86M BREAKER FAULT 30X ,101-MAIN BHCH/WTW ALARM 30, G1/2 ,107-OTI PRV ALARM, 107 PD TRIP 30B ,301-N2 L/O/CB AUTO TRIP 30D 307-	NA	NIL	DUE TO MALFUNCTIONING OF SAS CMR RELAY	EQUIP MENT MAL OPER ATION (SEMT )	Informed to O&M wing for required action

Name of Feeder/TF & CB No.	Type of Relay / Scheme	Date&Time of Tripping	Date& Time of closing	flags observed	Other end flage	affected generation/ load	Tripping Analysis / Action taken report	Category Code	Action Taken
				CB BC 2 FAIL/OIL PRESSURE TROUBLE 30 E 781-TRIP RELAY 86					
50 MVA T/F 1	GE	25.06.23 07:43	25:06:23 13:18	CP-T/F OSR TRIP RP-MTR HV/LV MTR-1 86- 1/86-2 MTR 86-3	NA	NIL	DUE TO MALFUNCTI ONING OF SAS CMR RELAY	EUIP MENT MAL OPER ATION (SEMT )	Informe d to O&M wing fpr required action
CB NO.881/7 81 160MVA T/F 1	AREV A	25.06.23 19:50	25:06:23 20:42	CP-BREAKER PD TRIP BREAKER TROBLE ALARM RP-TRIP 86B/86M BREAKER FAULT 30X TRIP RELAY 86B 781-CP- TRIP RELAY COIL UNHEALTHY RP-TRIP RELAY 86	NA	NIL	DUE TO MALFUNCTI ONING OF SAS CMR RELAY	EUIP MENT MAL OPER ATION (SEMT )	Informe d to O&M wing fpr required action
50 MVA T/F 1	GE	27.06.23 13:02	27:06:23 18:20	50 MVA T/F TRIP WITH 33KV CB NO.10 BREAKER TRIP CKT 1/2 FAULTY	NA	NIL	TRIPPED WITH CB NO. 10(CT BLAST)	SEFT	Informe d to O&M wing fpr required action
CB NO 72 JWALAPU R	MICO M	08.07.23 09:30	08.07.23 09:48	CP-BREAKER AUTO TRIP, DIST TRIP RP-R PHASE DIST TRIP 86 MTR ,DP I>PHASE AB1/2 BREAKER FAULTY 30Y DIST START Z1 Z3 DIST TRIP Z3 DIST=4.157KM IA=4.13KA IB=4.214KA IC 53.93A	BACKUP RELAY DIR E/F OPTD DIST START RP -MTR 86-1 86-2	NIL	TRANSIENT LINE FAULT	TLF	Informe d to O&M wing fpr required action
25 MVA T/F	AREV A	11.07.23 14:50	11.07.23 16:08	CP-MTR HV MTR LV 27 PICKUP RELAY	NA	NIL	LA BLAST (EQUIPMEN T FAILURE)	SEFT	Informe d to O&M

Name of Feeder/TF & CB No.	Type of Relay / Scheme	Date&Time of Tripping	Date& Time of closing	flags observed	Other end flage	affected generation/ load	Tripping Analysis / Action taken report	Category Code	Action Taken
				STARTED PHASE ABC TRIPPED PHASE ABC F=49.98HZ IA(HV)=218.6 IB(HV)=508.4A IC(HV)=115A IA(LV)=287.1A IB(LV)=535.9A IC(LV)=713.6A					wing fpr required action
50 MVA T/F	GE	12-07-23 18:01	12-07-23 19:55	CP-PRV TRIP BREAKER TRIP CKT1/2 FAULTY RP-R PHASE TRIP CKT 2 SUPVN RELAY(95-Y) MTR86-1(HV) 86-3(LV) PRV TRIP 80 MTR 86-2 DC SUPVN RELAY80	NA	NIL			Informe d to O&M wing fpr required action
CB NO.72 ROORKEE	SIEMENS	06-08-2023 21:26	06-08-2023 22:21	DIST PROTN OPTD DIST=100KM IA=0.14KA IB=0.24KA IC=4.16KA MAIN 3 PHASE 86-1	DIFF PROTN OPTD MTR OPTD DIST PROTN STARTED LED=1,3,5,9 DIST=5.3KM IA=0.36KA IB=5.58KA IC=0.29KA MTR-186	NIL	TRANSIENT LINE FAULT	TLF	Informe d to O&M wing fpr required action
50MVA T/F	GE	19-08-2023 17:58	19-08-2023 18:37	CP-50/51G TRIP RP-MTR-1,2,3	NA	NA	<b>TRIPPED WITH CB NO. 10 DUE TO OVER CURRENT</b>	TLF	Informe d to O&M wing fpr required action
CB NO 74 ROORKEE LINE	MICOM	26-08-2023 23:27	26-08-2023 23:45	CP-BACKUP RELAY DIR O/C OPTD RP-MAIN RELAY 86-1 86-2 67/67N TRIP 50/51 P TRIP IA=0.61A IB=0.62A IC=0.61A	NA	NIL	TRANSIENT LINE FAULT	TLF	Informe d to O&M wing fpr required action
80 MVA T/F-1 CB 783/383	AREVA	02-09-2023 06:45	02-09-2023 7:54	BREAKER AUTO TRIP RP-TRIP RELAY 86M TRIP	NA	NIL	<b>CB NO. 1 BREAKER DAMAGE DUE TO</b>	SEFT	Informe d to O&M wing fpr



Name of Feeder/TF & CB No.	Type of Relay / Scheme	Date&Time of Tripping	Date& Time of closing	flags observed	Other end flage	affected generation/ load	Tripping Analysis / Action taken report	Category Code	Action Taken
				RELAY 86Y BREAKER FAULTS 30X 30Y			<b>HEAVY FAULT CURRENT</b>		required action
<b>CB NO. 881,882/ 781,782 160 MVA T/F-1,2</b>	AREV A	05-09-2023 12:40	05-09-2023 12:55	DIR O/C EF TRIP I PHASE ABC-1/2 IC>EARTH 2/3 EI PHASE 3/3 T/P RELAY 86B 86M 882-DIR O/C E/F T/P I>PHASE ABC- 1/2 EI>PHASE C 2/2 T/P RELAY 86B 781/782- BREAKER FAULT 30Y 30X T/P RELAY 86	NA	NIL	DUE TO HERO MOTOR'S MTR FAULTY		Informe d to O&M wing fpr required action
<b>CB NO. 881/781 882/782</b>	AREV A	30-09-2023 00:40	30-09-2023 01:08	881- CP-0/C E/F OPTD RP-86M 86B I>PHASE ABC IE>EARTH I> PHASE C 781-RP- 86 BREAKER FAULT 30X 882-CP-DIR O/C E/F OPTD RP-86M 86B I>PHASE ABC Ti>PHASE C	NA	NIL	OVERLOADI NG	CMST	Informe d to O&M wing fpr required action
<b>CB NO 78 JWALAPU R</b>	MICO M	16-10-2023 12:33	16-10-2023 12:52	CP-POLE BREAKER AUTO TRIP DIST START DIST TRIP RP-DIST START Z1 Z2 Z3 DIST TRIP Z1 FD=45ms CB=40ms RTT=0ms DIST=435.7m IA=422.3A IB=12.55KA IC=4119A 27R 27Y 27B	CP-ANY TRIP Y PHASE TRIP Z1 TRIP 86-1,2 DIST=3.4KM IA=IC=0 IB=11.09KA	NIL	TRANSIENT LINE FAULT	TLF	Informe d to O&M wing fpr required action
<b>CB NO 78 JWALAPU R</b>	MICO M	16-10-2023 13:02	16-10-2023 15:03	CP-POLE BREAKER AUTO TRIP DIST START	NA	NIL	TRANSIENT LINE FAULT	TLF	Informe d to O&M wing fpr

Name of Feeder/TF & CB No.	Type of Relay / Scheme	Date&Time of Tripping	Date& Time of closing	flags observed	Other end flage	affected generation/ load	Tripping Analysis / Action taken report	Category Code	Action Taken	
				DIST TRIP RP-DIST START Z1 Z2 Z3 DIST TRIP Z1 FD=45ms CB=40ms RTT=0ms DIST=435.7m IA=422.3A IB=12.55KA IC=4119A 27R 27Y 27B						required action

## 5.0. Observations and Recommendations

### 5.1. Reporting of all the Tripping with DR/EL

- a. For the interstate lines, as per IEGC clause 37.2(c) and clause 15.3 of CEA grid standard, all the DR/EL reports shall be uploaded on Web Based Tripping Monitoring System “http://103.7.128.184/Account/Login.aspx” within 24 hours of the events. These are being submitted by sub-station to NRLDC portal, however the record of the same is not kept at sub-station level.

Status of submission of FIR/DR/EL/Tripping Report on NR Tripping Portal																								
Time Period: 1st January 2024 - 31st January 2024																								
S. No.	Utility	Total No. of tripping	First Information Report (Not Received)		Disturbance Recorder (Not Received)		Disturbance Recorder (NA) as informed by utility		Disturbance Recorder (Not Received)		Event Logger (Not Received)		Event Logger (NA) as informed by utility		Event Logger (Not Received)		Tripping Report (Not Received)		Tripping Report (NA) as informed by utility		Tripping Report (Not Received)		Remark	
			Value	%	Value	%	Value	%	Value	%	Value	%	Value	%	Value	%								
36	SLDC-PS	29	2	7	13	6	57	13	5	54	16	0	55											
37	SLDC-RS	130	12	9	23	11	19	23	9	29	39	0	30											
38	SLDC-UK	6	0	0	0	4	0	0	4	0	1	3	33											
39	SLDC-UP	80	10	13	11	9	15	12	10	27	11	1	14											
40	STERLITE	1	0	0	0	0	0	0	0	0	0	1	0											
41	TANAKPUR-NH	4	1	25	1	0	25	1	0	25	1	0	25											
42	LUNDAHAR-NT	1	0	0	0	0	0	0	1	0	0	0	0											
Total in NR Region		520	147	28	169	69	37	171	76	38	185	17	37											

*As per the IEGC provision under clause 37.2 (c), detailed tripping report along with DR & EL has to be furnished within 24 hrs of the occurrence of the event*

Ref: NRPC 216 OCC Agenda (Annexure B.VIII)

- b. For the tripping of intra-state lines, the brief tripping reports are submitted to Divisional office. The DR/EL reports are downloaded by respective officials and forwarded, as per need basis. The record of these DR/EL is not kept at sub-stations
- c. It is recommended that each sub-station to have a central repository of such tripping reports, along with DR/EL reports and analysis. A dedicated PC can be kept for this.

### 5.2. Development of centralized database of relay settings

- a. In 48th TCC & 70th NRPC Meeting (held on 17-18 Nov 2023), NRPC Committee has approved for development of a portal through PSDF for Centralized database containing details of relay settings for grid elements connected to 220 kV and above. Portal shall have other features including protection setting calculation tool. A nodal officer shall be providing this data at central portal.
- b. The relay settings for below 220kV are to be calculated by SLDC and/or central level. The relays are tested by sub-station officials as per need basis, but the record of recommended settings/ calculation is not kept at sub-station level. This makes it difficult to validate the settings and test results, in case of relay testing.

- c. It is recommended that latest recommended relay settings, as decided by RLDC for 220kV & above and by SLDC below 220kV along with setting calculations & parameters used for all the relays be kept at sub-station level. This will help in proper fault analysis and ascertaining relay healthiness.

### **5.3. *Review of test results of relay and equipment***

- a. Testing of most of the equipment is carried out, as per availability of shut-down and testing equipment. After testing, the test records are summarily recorded in testing register, with remarks as “tested. OK”.
- b. For the numeric relay testing, the testing is carried out by supplier at the time of installation and subsequently as per need basis, including at the time of change in settings.
- c. A draft O&M manual is available at PTCUL web-site, which includes various tests and their frequency, along with results. This manual is based on CERC/SERC regulations of 2004-2008. It is recommended that this manual may be updated and implemented and record of test values may be kept for future reference.

### **5.4. *Availability of Testing Kits***

- a. The availability of testing equipment is limited at each substation. For comprehensive testing of equipment, as per above para, sufficient testing kits at each substation/Sub-division/ Division level are required.
- b. Based on the O&M manual, it is recommended that sufficient quantity of testing instruments be made available at sites for regular testing of equipment. A suggested list of Testing Equipment is attached at Annexure – 1.

### **5.5. *Up-dation of PTCUL Protection Philosophy***

The protection philosophy adopted by Utility, in general, is in alignment with protection philosophy adopted by NRPC. As the NRPC has recently updated the protection philosophy, PTCUL in consultation with SLDC may update protection philosophy for network not covered by NRPC, if needed, and implement the same.

### **5.6. *Simulation based study of protection system***

As per IEGC, protection code, during audit the relay settings to be adopted shall be validated with simulation based or EMTP studies and details shall be enclosed in report. The current scope of audit was excluding these studies, therefore, Simulation based or EMTP Studies should be carried out by the Utility, as per the requirement of Grid Code.

### **5.7. *Capacity Building of protection team***

During the discussions with officials at site, it was observed that the teams responsible for the protection system and SAS, needs to be updated on current trends on protection system, communication schemes and Sub-station automation. Utility may undertake capacity building exercise for the officials involved in these activities.

### **5.8. *Updated Fault Level/ Short Circuit Level and Network information***

The fault level/ short circuit level for each substation is being calculated at central level. Such studies are carried out, as and when new elements are added in the network. This has impact on relay settings parameters and equipment ratings. It is recommended that the updated network information and short circuit level be maintained at central level for revising the setting as per requirement.

### **5.9. *General Protection related observations***

The study of Fire protection system/ Nitrogen Injection Fire Protection System, Lightning Protection system, Earthing Mat/ Earthing Protection are not covered under protection audit. Utility may get a comprehensive technical and safety audit carried out internally or thru third party and corrective action for any discrepancy be taken up accordingly.

### **5.10. *O&M Manual***

The Utility has a draft O&M manual uploaded on its website, which is being referred by working level officials as a guideline for regular O&M and testing functions. This manual needs to be updated to incorporate recent developments and approved for regular use in all sub-stations to bring uniformity in O&M and testing practices across the utility.

## 6.0. Station Specific Observation and Recommendations

### 6.1. Protection related observations and recommendations

- a. The major observations and recommendations of the previous audit report dated are to be complied with.
- b. Bus Bar Protection on 220KV Bus is not functional after addition of the new elements with the 220KV bus. It is recommended to make it functional.
- c. The events are recorded from individual relays, no separate Event Logger is provided. The SAS has the event logging capability. On 25th June 2023 in SIDCUL, Haridwar S/S, SAS Contact Multiplier Relay(s) malfunction observed at 7:00 hrs, 7:43 hrs and 19:50 hrs for 160MVA Transformer, 50MVA Transformer and 160MVA Transformer respectively. After malfunctions, SAS has been disabled and is not in service. Therefore, after detailed analysis and corrective actions, SAS needs to be put back into service ASAP.
- d. Following 22 No(s) numerical relays, being used as back-up protection are not provided with Time Sync Input and Communication Port. Necessary action for modification/upgradation needs to be taken, as per applicable protection philosophy.

Relay	No(s)
P127	11
P821	2
P122	9

- e. Two nos. of GPS Time Sync are provided one for SAS and other caters for relays and other equipments of S/S. Both GPS are not functional.
- f. PLCC is unhealthy and therefore tele protection is out of service and both the 220kV circuits are operating without carrier protection. Carrier aided protection is needed for successful auto-reclosures.

### 6.2. Equipment related observations and recommendations

- a. PTCUL has submitted a list of switchyard equipments to be replaced under PSDF funding, as per Annexure - 2. In view of the need of modern sub-stations, where automation of sub-station is of paramount importance, these replacements are required. Based on the specifications and healthiness of existing equipments, the list may be reviewed by PTCUL. In addition, it is recommended that sufficient quantity of maintenance equipments be made available at sites. A suggested list of **Maintenance Equipment is attached at Annexure – 3.**

- b. Both the 220/33 KV T/Fs cannot be connected through TBC as Transfer Bus arrangement is not extended for these two T/Fs. For the testing/ maintenance of associated circuit breakers of transformers, transformer shut down is required. In order to maintain reliability, the charging of 220kV side of transformer using TBC needs to be explored.

### **6.3. *Auxiliary Equipment related observations and recommendations***

- a. Both the 220V DC systems are showing earth-fault. Corrective actions need to be taken.
- b. Only one 48V battery system is provided. In case carrier aided tripping is extended using PLCC in future, second battery bank would be required.

## Annexure – 1: Suggested List of Testing Instruments

CBIP suggests the following list of testing instruments based on the approved O&M manual

Sl. No.	Testing Instruments
1	DCRM for Circuit Breaker
2	DC Earth Fault Locator
3	SF6 Gas Density Monitor
4	SF6 Gas Leakage detector/ Imaging Camera
5	CB Analyser
6	Earth Resistance Tester
7	Portable Digital Selective Level Meter cum Level Generator
8	Selective Level Generator
9	LA Leakage Current Analyser
10	Digital Multi-meter
11	Tong Tester
12	Tan Delta Test Kit
13	Digital Leakage Clamp Meter
14	Phase Sequence Indicator
15	Megger (5 kV)
16	Digital Capacitance Meter
17	CT Polarity Tester
18	PT Test Set



## Annexure – 2: Suggested List of Substation Equipments

The suggested list of Substation Equipments keeping in mind the necessity for the modernization and upgradation of substations.

Sl. No.	Equipment	Unit	Quantity
<b>A</b>	<b>220KV Equipment</b>		
<b>1</b>	245KV Current Transformer (5 Core), Class 0.2s (1ph), 1600/800/1, (Protection Core)800/400/1 (merering Core)	Nos	6
<b>2</b>	245KV Bus PT	Nos	6
<b>B</b>	<b>132KV Equipment</b>		
<b>1</b>	145KV Isolator 3Ph (with Earth Swich)	Nos	2
<b>2</b>	145KV Isolator 3Ph (without Earth Swich)	Nos	1
<b>3</b>	145KV Current Transformer 1Ph (5 Core), Class 0.2s (1ph) 800/400/1	Nos	6
<b>4</b>	145KV PT	Nos	3
<b>C</b>	<b>33KV Equipment</b>		
<b>1</b>	33KV Circuit Breaker	Nos	3
<b>2</b>	33KV Isolator 3Ph with earth switch (1600 Amp)	Nos	12
<b>3</b>	33KV Current Transformer 1 Ph	Nos	9

### **Annexure – 3: Suggested List of Maintenance Equipments**

<b>Sl. No.</b>	<b>Equipment</b>
<b>1</b>	Oil Filter Machine
<b>2</b>	SF6 Gas Handling Plant
<b>3</b>	SF6 Gas Density Monitor
<b>4</b>	Thermo-Vision Camera Lines and Sub-Station
<b>5</b>	Binocular Vision Camera
<b>6</b>	SF6 Gas Leakage Imaging Camera
<b>7</b>	LA Leakage Current Analyser
<b>8</b>	Online DGA
<b>9</b>	Oil BDV Kit
<b>10</b>	Hydraulic Crimping Tool for different Types of ACSR Conductor
<b>11</b>	Hydraulic Conductor Cutter
<b>12</b>	Fork Lift 5 Ton Capacity
<b>13</b>	Digital Leakage Clamp Meter

A mobile van with test kits can be kept for optimizing the resources at various substations

## Annexure – 4: Protection Code (IEGC 2023 Chapter 4)

- **General**

1. This chapter covers the protection protocol, protection settings and protection audit plan of electrical systems.
2. There shall be a uniform protection protocol for the users of the grid:
  - a) for proper co-ordination of protection system in order to protect the equipment/system from abnormal operating conditions, isolate the faulty equipment and avoid unintended operation of protection system;
  - b) to have a repository of protection system, settings and events at regional level;
  - c) specifying timelines for submission of data;
  - d) to ensure healthiness of recording equipment including triggering criteria and time synchronization; and
  - e) to provide for periodic audit of protection system.

- **Protection protocol**

1. All users connected to the integrated grid shall provide and maintain effective protection system having reliability, selectivity, speed and sensitivity to isolate faulty section and protect element(s) as per the CEA Technical Standards for Construction, the CEA Technical Standards for Connectivity, the CEA (Grid Standards) Regulations, 2010, the CEA Technical Standards for Communication and any other applicable CEA Standards specified from time to time.
2. Back-up protection system shall be provided to protect an element in the event of failure of the primary protection system.
3. RPC shall develop the protection protocol and revise the same, after review from time to time, in consultation with the stakeholders in the concerned region, and in doing so shall be guided by the principle that minimum electrical protection functions for equipment connected with the grid shall be provided as per the CEA Technical Standards for Construction, the CEA Technical Standards for Connectivity, the CEA Technical Standards for Communication, the CEA (Grid Standards) Regulations, 2010, the CEA (Measures relating to Safety and Electric Supply) Regulations, 2010, and any other CEA standards specified from time to time.

4. The protection protocol in a particular system may vary depending upon operational experience. Changes in protection protocol, as and when required, shall be carried out after deliberation and approval of the concerned RPC.
5. Violation of the protection protocol of the region shall be brought to the notice of concerned RPC by the concerned RLDC or SLDC, as the case may be.

- **Protection settings**

1. RPCs shall undertake review of the protection settings, assess the requirement of revisions in protection settings and revise protection settings in consultation with the stakeholders of the respective region, from time to time and at least once in a year. The necessary studies in this regard shall be carried out by the respective RPCs. The data including base case (peak and off-peak cases) files for carrying out studies shall be provided by RLDC and CTU to the RPCs:
2. All users connected to the grid shall:
  - a) furnish the protection settings implemented for each element to respective RPC in a format as prescribed by the concerned RPC;
  - b) obtain approval of the concerned RPC for,
    - i. any revision in settings, and,
    - ii. implementation of new protection system;
  - c) intimate to the concerned RPC about the changes implemented in protection system or protection settings within a fortnight of such changes;
  - d) ensure correct and appropriate settings of protection as specified by the concerned RPC.
  - e) ensure proper coordinated protection settings.
3. RPCs shall:
  - a) maintain a centralized database and update the same on periodic basis in respect of their respective region containing details of relay settings for grid elements connected to 220 KV and above (132 KV and above in NER). RLDCs shall also maintain such database.
  - b) carry out detailed system studies, once a year, for protection settings and advise modifications / changes, if any, to the CTU and to all users and STUs of their respective regions. The data required to carry out such studies shall be provided by RLDCs and CTU.

- c) provide the database access to CTU and NLDC and to all users, RLDC, SLDCs, and STUs of the respective regions. The database shall have different access rights for different users.
4. The changes in the network and protection settings of grid elements connected to 220KV and above (132 KV and above in NER) shall be informed to RPCs by CTU and STUs, as the case may be.

The elements of network below 66KV and radial in nature which do not impact the National Grid may be excluded as finalized by the respective RPC.

- **Protection audit plan**

1. All users shall conduct internal audit of their protection systems annually, and any shortcomings identified shall be rectified and informed to their respective RPC. The audit report along with action plan for rectification of deficiencies detected, if any, shall be shared with respective RPC for users connected at 220 KV and above (132 KV and above in NER).
2. All users shall also conduct third party protection audit of each substation at 220 KV and above (132 KV and above in NER) once in five years or earlier as advised by the respective RPC.
3. After analysis of any event, each RPC shall identify a list of substations / and generating stations where third-party protection audit is required to be carried out and accordingly advise the respective users to complete third party audit within three months.
4. The third-party protection audit report shall contain information sought in the format enclosed as Annexure–1. The protection audit reports, along with action plan for rectification of deficiencies detected, if any, shall be submitted to the respective RPC and RLDC or SLDC, as the case may be, within a month of submission of third-party audit report. The necessary compliance to such protection audit report shall be followed up regularly in the respective RPC.
5. Annual audit plan for the next financial year shall be submitted by the users to their respective RPC by 31<sup>st</sup> October. The users shall adhere to the annual audit plan and report compliance of the same to their respective RPC.
6. Users shall submit the following protection performance indices of previous month to their respective RPC and RLDC on monthly basis for 220 KV and above (132 KV and above in NER) system, which shall be reviewed by the RPC:
  - a. The Dependability Index defined as

$$D = \frac{N_c}{N_c + N_f}$$

where,

$N_c$  is the number of correct operations at internal power system faults and

$N_f$  is the number of failures to operate at internal power system faults.

- b. The Security Index defined as

$$S = \frac{N_c}{N_c + N_u}$$

where,

$N_c$  is the number of correct operations at internal power system faults

$N_u$  is the number of unwanted operations.

- c. The Reliability Index defined as

$$R = \frac{N_c}{N_c + N_i}$$

where,

$N_c$  is the number of correct operations at internal power system faults

$N_i$  is the number of incorrect operations and is the sum of  $N_f$  and  $N_u$

7. Each user shall also submit the reasons for performance indices less than unity of individual element wise protection system to the respective RPC and action plan for corrective measures. The action plan will be followed up regularly in the respective RPC.
8. In case any user fails to comply with the protection protocol specified by the RPC or fails to undertake remedial action identified by the RPC within the specified timelines, the concerned RPC may approach the Commission with all relevant details for suitable directions.

- **System Protection Scheme (SPS)**

1. SPS for identified system shall have redundancies in measurement of input signals and communication paths involved up to the last mile to ensure security and dependability.
2. For the operational SPS, RLDC or NLDC, as the case may be, in consultation with the concerned RPC(s) shall perform regular load flow and dynamic studies and mock testing for reviewing SPS parameters & functions, at least once in a year.
3. RLDC or NLDC shall share the report of such studies and mock testing including any short comings to respective RPC(s). The data for such studies shall be provided by CTU to the concerned RPC, RLDC and NLDC.
4. The users and SLDCs shall report about the operation of SPS immediately and detailed report shall be submitted within three days of operation to the concerned RPC and RLDC in the format specified by the respective RPCs.
5. The performance of SPS shall be assessed as per the protection performance indices specified in these Regulations. In case, the SPS fails to operate, the concerned User shall take corrective actions and submit a detailed report on the corrective actions taken to the concerned RPC within a fortnight.

- **Recording instruments**

1. All users shall keep the recording instruments (disturbance recorder and event logger) in proper working condition.
2. The disturbance recorders shall have time synchronization and a standard format for recording analogue and digital signals which shall be included in the guidelines issued by the respective RPCs.
3. The time synchronization of the disturbance recorders shall be corroborated with the PMU data or SCADA event loggers by the respective RLDC. Disturbance recorders which are non-compliant shall be listed out for discussion at RPC.

## **Annexure – 5: Third Party Protection System Checking & Validation Template for a Substation (IEGC 2023 Annexure – 1)**

### **1. Introduction:**

- a. The audit reports, along with action plan for rectification of deficiencies found, if any, shall be submitted to RPC or RLDC within a month of submission of report by auditor.
- b. The third-party protection system checking shall be carried at site by the designated agency. The agency shall furnish two reports:
  - i. Preliminary Report: This report shall be prepared on the site and shall be signed by all the parties present.
  - ii. Detailed Report: This report shall be furnished by agency within one month after carrying out detailed analysis.

### **2. Checklist:**

- a. The protection system checklist shall contain information as per this Regulation.
  - i. General Information (to be provided prior to the checking as well as to be included in final report):
    - Substation name
    - Name of Owner Utility
    - Voltage Level (s) or highest voltage level
    - Short circuit current rating of all equipment (for all voltage level) (v) Date of commissioning of the substation
    - Checking and validation date
    - Record of previous tripping's (in last one year) and details of protection operation
    - Previous Relay Test Reports
    - Overall single line diagram (SLD) (x) AC aux SLD
    - DC aux SLD
    - SAS architecture diagram
    - SPS scheme implemented (if any)



b. The preliminary report shall inter-alia contain the following:

**FORMAT OF PRELIMINARY REPORT**

S. No.	Issues	Remarks
<b>1</b>	<b>Recommendation of last protection checking and validation</b>	Status of works & pending issues if any
<b>2</b>	<b>Review of existing settings at substation</b>	Recommended Action
<b>3</b>	<b>Disturbance Recorder out/ available for last 6 trippings (Y/N)</b>	Recommended Action
<b>4</b>	<b>Chronic reason of tripping, if any</b>	Recommended Action
<b>5</b>	<b>Major non-conformity/deficiency observed</b>	Recommended Action

c. The **relay configuration check-list** for available power system elements at station:

- Transmission Line
- Bus Reactor/Line Reactor
- Inter-connecting Transformer
- Busbar Protection Relay
- AC auxiliary system
- DC auxiliary system
- Communication system
- Circuit Breaker Details
- Current Transformer details
- Capacitive Voltage Transformers Details
- Any other equipment/system relevant for protection system operation

d. The **minimum set of points on which checking & validation** shall be carried out is covered in this clause. The detailed list shall be prepared by checking and validation team in consultation with concerned entity, RLDC and RPC.

**i. Transmission Line Distance Protection/Differential Protection;**

- Name and Length of Line
- Whether series compensated or not
- Mode of communication used (PLCC/OPGW)
- Relay Make and Model for Main-I and Main-II

- List of all active protections & settings
- Carrier aided scheme if any
- Status of Power Swing/Out of Step/SOTF/Breaker Failure/Broken Conductor/STUB/Fault Locator/DR/VT fuse fail/Overvoltage Protection/Trip Circuit supervision/Auto-reclose/Load encroachment etc.
- Relay connected to Trip Coil-1 or 2 or both i. CT ratio and PT ratio
- Feed from DC supply-1 or 2
- Connected to dedicated CT core (mention name)
- Other requirements for protection checking and validation

**ii. Shunt Reactor & Inter-connecting Transformer (ICT) Protection;**

- Whether two groups of protections used (Group A and Group B)
- Do the groups have separate DC sources
- Relay Make and Model
- List of all active protections along with settings
- Status of Differential Protection/Restricted Earth Fault Protection/Back-up Directional Overcurrent/Backup Earth fault/ Breaker Failure
- Status of Oil Temperature Indicator/Winding-Temperature Indicator/Bucholz/Pressure Release Device etc.
- Relay connected to Trip Coil-1 or 2 or both
- CT ratio and PT ratio
- Feed from DC supply-1 or 2
- Connected to dedicated CT core (mention name)
- Other requirements for protection checking and validation

**iii. Busbar Protection Relay;**

- Busbar and redundant relay make and model
- Type of Busbar arrangement
- Zones
- Dedicated CT core for each busbar protection (Yes/No)
- Breaker Failure relay included (Yes/No), if additional then furnish make and model
- Trip issued to both Busbar protection in case of enabling
- Isolator indication and check relays
- Other requirements for protection checking and validation

**iv. AC auxiliary system;**

- Source of AC auxiliary system
- Supply changeover between sources (Auto/Manual)
- Diesel generator (DG) details
- Maintenance plan and supply changeover periodicity in DG
- Single Line Diagram
- Other requirements for protection checking and validation

**v. DC auxiliary system;**

- Type of Batteries (Make, vintage, model)
- Status of battery Charger
- Measured voltage (positive to earth and negative to earth)
- Availability of ground fault detectors
- Protection relays and trip circuits with independent DC sources
- Other requirements for protection checking and validation
- Communication system
  - Mode of communication for Main-1 and Main-2 protection
  - Mode of communication for data and speech communication
  - Status of PLCC channels
  - Time synchronization equipment details
  - 7OPGW on geographically diversified paths for Main-1 and main-2 relay
  - Other requirements for protection checking and validation

**vi. Circuit Breaker Details;**

- Details and Status
- Healthiness of Tripping Coil and Trip circuit supervision relay
- Single Pole/Multi pole operation
- Pole Discrepancy Relay available (Y/N)
- Monitoring Devices for checking the dielectric medium
- Other requirements for protection checking and validation
- Current Transformer (CT)/Capacitive Voltage Transformer (CVT) Details
  - CT/CVT ID name and voltage level
  - CT/CVT core connection details
  - Accuracy Class

- Whether Protection/Metering
- CT/CVT ratio available and ratio adopted
- Details of last checking and validation of CT/CVT healthiness
- Other requirements for protection checking and validation
- Other protections: Direction earth fault, negative sequence, over current, over voltage, over frequency, under voltage, under frequency, forward power, reverse power, out of step/power swing, HVDC protection etc.

### 3. Summary of checking:

The summary shall specifically mention minimum following points:

- a) The settings and scheme adopted are in line with agreed protection philosophy or any accepted guidelines (e.g. Ramakrishna guidelines or CBIP manual based).
- b) The deviations from the RPC protection philosophy, if any and reasons for taking the deviations shall be recorded.
- c) All the major general deficiency shall be listed in detail along with remedial recommendations.
- d) The relay settings to be adopted shall be validated with simulation based or EMTP studies and details shall be enclosed in report.
- e) The cases of protection maloperation shall be analysed from protection indices report furnished by concerned utility, the causes of failure along with corrective actions and recommendations based on the findings shall be noted in the report.

## Annexure – 6: Protection Philosophy/Protocol of Northern Region

The Protection Philosophy/Protocol of Northern Region is developed in compliance of IEGC 2023, Version 2.0 which was approved in 71<sup>st</sup> NRPC meeting held on 29.01.2024.

S.N.	Protection Setting/Protocol	Mandated Setting for transmission lines
1	<b>Protection Scheme</b>	<p>220KV and above: Independent Main-I and Main-II protection (of different make OR different type/different algorithm) of non-switched numerical type is to be provided with carrier aided scheme.</p> <p>132KV and below: One non-switched distance protection scheme and, directional over current and earth fault relays, should be provided as back up.</p>
2	<b>Distance Protection Zone-1</b>	<p>Reach: 80% of the protected line; 110% of the protected line (In case of radial lines) Time Setting: Instantaneous.</p>
3	<b>Distance Protection Zone-2</b>	<p>Reach: Single Circuit Line: 120% of length of principle line section. Double circuit line: 150% coverage of line to take care of under reaching due to mutual coupling effect.</p> <p>Time setting: i. 0.35 second <i>(considering LBB time of 200mSec, CB open time of 60ms, resetting time of 30ms and safety margin of 60ms)</i> ii. 0.5-0.6 second <i>(For a long line followed by a short line)</i></p>

S.N.	Protection Setting/Protocol	Mandated Setting for transmission lines
4	<b>Distance Protection Zone-3</b>	<p>Reach: Zone-3 should overreach the remote terminal of the longest adjacent line by an acceptable margin (typically 20% of highest impedance seen) for all fault conditions.</p> <p>Time Setting: 800-1000 msec</p> <p>If zone-3 reach transcends to other voltage level, time may be taken up to 1.5 sec.</p>
5	<b>Distance Protection Zone- 4</b>	<p>The Zone-4 reverse reach must adequately cover expected levels of apparent bus bar fault resistance.</p> <p>Time may be coordinated accordingly.</p> <p>Where Bus Bar protection is not available, time setting: 160 msec.</p>
6	<b>Lines with Series and other compensations in the vicinity of Substation</b>	<ul style="list-style-type: none"> <li>• Zone-1: FSC end: 60% of the protected line. Time: Instantaneous; Remoted end: 60% of the protected line with 100ms-time delay. POR Communication scheme logic is modified such that relay trips instantaneously in Zone-1 on carrier receive.</li> <li>• Zone-2: 120 % of uncompensated line impedance for single circuit line. For Double circuit line, settings may be decided on basis of dynamic study in view of zero sequence mutual coupling.</li> <li>• Phase locked voltage memory is used to cope with the voltage inversion. Alternatively, an intentional time delay may be applied to overcome directionality problems related to voltage inversion.</li> <li>• Over-voltage stage-I setting for series compensated double circuit lines may be kept higher at 113%.</li> </ul>

S.N.	Protection Setting/Protocol	Mandated Setting for transmission lines
7	<b>Power Swing Blocking</b>	<ul style="list-style-type: none"> <li>• Block tripping in all zones, all lines.</li> </ul> Out of Step tripping to be applied on all inter-regional tie lines. Deblock time delay = 2s
8	<b>Protection for broken conductor</b>	Negative Sequence current to Positive Sequence current ratio more than 0.2 (i.e. $I_2/I_1 \geq 0.2$ ) Alarm Time delay: 3-20 sec. Tripping may be considered for radial lines to protect single phasing of transformers.
9	<b>Switch on to fault (SOTF)</b>	Switch on to fault (SOTF) function to be provided in distance relay to take care of line energization on fault.
10	<b>VT fuse fail detection function</b>	VT fuse fail detection function shall be correctly set to block the distance function operation on VT fuse failure.
11	<b>Carrier Protection</b>	To be applied on all 220KV and above lines with the only exception of radial feeders.
12	<b>Back up Protection</b>	<ol style="list-style-type: none"> <li>1. On 220KV and above lines with 2 Main Protections:               <ul style="list-style-type: none"> <li>• Back up Earth Fault protections alone to be provided.</li> <li>• No Over current protection to be applied.</li> </ul> </li> <li>2. At 132KV and below lines with only one Main protection:               <ul style="list-style-type: none"> <li>• Back up protection by IDMT O/C and E/F to be applied.</li> </ul> </li> </ol>

S.N.	Protection Setting/Protocol	Mandated Setting for transmission lines
13	<b>Auto Reclosing with dead time.</b>	<p>AR shall be enabled for 220 KV and above lines for single pole trip and re-closing.            Dead time = 1.0s. Reclaim time = 25.0s</p> <p>Auto-recloser shall be blocked for following:</p> <ul style="list-style-type: none"> <li>• Faults in cables</li> <li>• Breaker Fail Relay</li> <li>• Line Reactor Protections</li> <li>• O/V Protection</li> <li>• Received Direct Transfer trip signals</li> <li>• Busbar Protection</li> <li>• Zone 2/3 of Distance Protection</li> <li>• Circuit Breaker Problems.</li> </ul> <p>CB Pole discrepancy relay time:1.5 sec; for tie breaker: 2.5 sec</p>
14	<b>Busbar protection</b>	To be applied on all 220KV and above sub stations with the only exception of 220KV radial fed bus bars.
15	<b>Local Breaker Backup (LBB)</b>	<p>For 220 KV and above level substations as well as generating stations switchyards, LBB shall be provided for each circuit breaker.</p> <p>LBB Current sensor I &gt; 20% In LBB time delay = 200ms</p> <p>In case of variation in CT ratio, setting may be done accordingly.</p>
16	<b>Line Differential</b>	<p>For cables and composite lines, line differential protection with built in distance back up shall be applied as Main-I protection and distance relay as Main-II protection.</p> <p>For very short line (less than 10 km), line differential protection with distance protection as</p>



S.N.	Protection Setting/Protocol	Mandated Setting for transmission lines
		<p>backup (built- in Main relay or standalone) shall be provided mandatorily as Main-I and Main-II.</p> <p>Differential protection may be done using dark fiber (preferably), or using bandwidth.</p>
17	Over Voltage Protection	<p>FOR 765KV LINES/CABLE:  Low set stage (Stage-I): 106% - 109% (typically 108%) with a time delay of 5 seconds.  High set stage (Stage-II): 140% - 150% with a time delay of 100 milliseconds.</p> <p>400KV LINES/CABLE:  Low set stage (Stage-I): 110% - 112% (typically 110%) with a time delay of 5 seconds.  High set stage (Stage-II): 140% - 150% with a time delay of 100 milliseconds.</p> <p>FOR 220 KV LINES:  No over-voltage protection shall be used.</p> <p>FOR 220 KV CABLE:  Low set stage (Stage-I): 110% - 112% (typically 110%) with a time delay of 5 seconds.  High set stage (Stage-II): 140% - 150% with a time delay of 100 milliseconds.</p> <p>Drop-off to pick-up ratio of overvoltage relay:  better than 97%</p> <p>Grading: Voltage as well as time grading may be done for multi circuit lines/cable.</p>

S.N.	Protection Setting/Protocol	Mandated Setting for transmission lines
18	<b>Resistive reach setting to prevent load point encroachment</b>	<p>Following criteria may be considered for deciding load point encroachment:</p> <ul style="list-style-type: none"> <li>• Maximum load current (<math>I_{max}</math>) may be considered as 1.5 times the thermal rating of the line or 1.5 times the associated bay equipment current rating (the minimum of the bay equipment individual rating) whichever is lower. (Caution: The rating considered is approximately 15minutes rating of the transmission facility).</li> <li>• Minimum voltage (<math>V_{min}</math>) to be considered as 0.85pu (85%).</li> </ul>
19	<b>Direct Inter-trip</b>	<p>To be sent on operation of following:</p> <ol style="list-style-type: none"> <li>i. Overvoltage Protection</li> <li>ii. LBB Protection</li> <li>iii. Busbar Protection</li> <li>iv. Reactor Protection</li> <li>v. Manual Trip (400 KV and above)</li> <li>vi. Cable Fault (in composite lines)</li> </ol>
20	<b>Permissive Inter-trip</b>	To be sent on operation of Distance Protection

## Annexure – 7: Work Order & Corrigendum



पावर ट्रांसमिशन कारपोरेशन ऑफ उत्तराखण्ड लि0  
(उत्तराखण्ड सरकार का उपक्रम)  
अधीक्षण अभियन्ता (परीक्षण एवं परिचालन एवं स्काडा) कार्यालय  
कुमांयु मण्डल हल्द्वानी  
मोबाइल नं0 9412089275, ईमेल dp\_singh@ptcul.org

No. 376 /SE (T&C)/PTCUL/ (H)/

Date:29.09.2023

Subject:- Order for Protection Audit of 02 Nos 400 kV and 08 Nos 220KV sub-stations in PTCUL.

Joint Advisor

Central Board of Irrigation and Power

Malcha Marg Chanakyapuri,

New Delhi-110021

Email: mrchauhan@cbip.org.

Dear Sir,

In reference to your offer submitted vide Ref No: P-1/CBIP/PTCUL/PTCUL/Audit/2023 dated: 11.09.2023 through email against Email enquiry dated 05.09.2023, an order is hereby placed in favour of your firm for the work of "Protection Audit of 02 Nos 400kV and 08 Nos 220 kV substations of PTCUL" The detail of material, price schedule and terms & conditions is here as under:-

Sr.No	Description	Unit	Qty	Amount	Total Amount
1	Protection Audit to be carried out for the following 10 nos of the 400/220kV substations of PTCUL :- 1. 400kV S/s Rishikesh 2. 400 kV S/s Kashipur 3. 220kV S/s Chamba 4. 220kV S/s Rishikesh 5. 220kV S/s Roorkee 6. 220kV S/s Haridwar (SIDCUL) 7. 220kV S/s Jhajra. 8. 220 kV S/s Pantnagar. 9. 220 kV S/s Haldwani. 10. 220kV S/s Mahuakheraganj.	Job	1	36,25,000	36,25,000
TOTAL					36,25,000

Total value of order is Rs.36,25,000 (Rupees Thirty Six Lakh Twenty Five Thousand only ) Plus GST Extra.

End: 1. Terms & Conditions.

Please acknowledge the receipt and acceptance of order.

(D.P Singh)

Superintending Engineer (T&C), Haldwani

No.376 /SE (T&C)/PTCUL/ (H)/

Date:29.09.2023

Copy forwarded to the following for information and necessary action:-

1. Director (Operation), PTCUL, Dehradun.
2. Superintending Engineer (A) MD, PTCUL, Dehradun.
3. Chief Engineer, T&C PTCUL, 132kV Substation Campus, Kathgodam Nainital.
4. Executive Engineer, T&C Division, Kashipur.
5. Director (Energy), Central Board of Irrigation and Power Malcha Marg Chanakyapuri, New Delhi-110021 Email: [sanjeev@cbip.org](mailto:sanjeev@cbip.org)

(D.P Singh)

Superintending Engineer (T&C), Haldwani

मुख्यालय एवंपंजीकृत कार्यालय:-विद्युतमवन, नजदीक-आई0एस0बी0टी0 क्रासिंग, सहारनपुररोड, माजरा, देहरादून-248002  
कारपोरेटआईडी नं0: U40101UR2004GOI028675 दूरभाष नं0 0135-2646000 फॅक्स नं0 0135-2643460 वेबसाइट [www.ptcul.org](http://www.ptcul.org)



पावर ट्रांसमिशन कारपोरेशन ऑफ उत्तराखण्ड लि०  
(उत्तराखण्ड सरकार का उपक्रम)  
अधीक्षण अभियन्ता (परीक्षण एवं परिचालन एवं स्काडा) कार्यालय  
कुमायु मण्डल हल्द्वानी  
मोबाइल नं० 9412089275, ईमेल dp\_singh@ptcul.org

Terms & Conditions:-

1	Scope	<p>: The detailed Scope work is as under:</p> <ol style="list-style-type: none"><li>1. There must be a kick off meeting for discussion on project plan before start of the work in field and the detailed plan of performance shall be submitted by CBIP.</li><li>2. Requisite data shall be collected in standard format from PTCUL grid substations by authorized and experienced auditor.</li><li>3. The site surveys and audit of grid substations of PTCUL shall be done by authorized and experienced auditor.</li><li>4. Review of the implemented protection schemes/philosophy for 400/220 kV substations which includes protection of transmission lines,interconnecting transformers, line/busreactors, bus bar, bus couplers etc.as per latest guidelines of Ramakrishna committee/CBIP/NRPC/Intenational best practices.etc.</li><li>5. Review the adequacy of primary and backup protection settings for protected equipment and suggest corrective measures where evernon compliance with respect to Ramakrishna committee/ CBIP/NRPC is found during the protection audit.</li><li>6. Review of availability/healthiness of PLCC communication links used for protection systems.</li><li>7. Review the healthiness/adequacy of 220/110/50V DC system available at substations for protection application.</li><li>8. Review of availability/healthiness of GPS system and time synchronization facility used for protection.</li><li>9. Review of availability/healthiness of recording instruments like DRs /ELs for transmission lines protection.</li><li>10. Review of test reports for assessing the healthiness of circuit breakers, CT &amp; CVT based upon available test reports at sites.</li><li>11. Field inspection of protection device for obsolescence of technology, suitability and healthiness.</li><li>12. Directory of the protection system &amp; recommendation for replacement of obsolescence relays with compatible numerical relays will be provided.</li><li>13. Checking of availability of DGset/auxiliary DC supply at substations.</li><li>14. Site visits for onsite protection audit, review and inspection of substations will be performed.</li><li>15. Submission of the detailed report for the protection audit including the protection philosophy, reviewed settings and protection audit observations.</li><li>16. The performance of above protection equipment like relays, circuit breaker, CT, CVT, DC battery bank, synchro facility, communication facility used for protection will be also checked through physical inspection and provided test reports/documents. These protection equipments will be recommended for renovation and upgradation based on their performance accessed during protection audit and physical inspection.</li><li>17. Review the availability healthiness of<ul style="list-style-type: none"><li>• Event recorders/ loggers' operation history</li><li>• CT, CVT, CB</li><li>• DC power supply</li><li>• Auxiliary supply</li><li>• Communication links</li><li>• Time synchronization/ GPS</li></ul></li><li>18. Review of Testing and Maintenance records of all protective relays, Circuit Breakers CT, CVT etc. Review of protection philosophy.</li></ol>
---	-------	--

मुख्यालय एवंपंजीकृत कार्यालय:-विद्युतमवन, नजदीक-आई०एस०बी०टी० क्रासिंग, सहारनपुररोड, माजरा, देहरादून-248002  
कारपोरेटआईडी नं०: U40101UR2004GOI028675 दूरभाष नं० 0135-2646000 फैक्स नं० 0135-2643460 वेबसाइटwww.ptcul.org





पावर ट्रांसमिशन कारपोरेशन ऑफ उत्तराखण्ड लि०  
(उत्तराखण्ड सरकार का उपक्रम)  
अधीक्षण अभियन्ता (परीक्षण एवं परिचालन एवं स्काडा) कार्यालय  
कुमायु मण्डल हल्द्वानी  
मोबाइल नं० 9412089275, ईमेल dp\_singh@ptcul.org

			19. Anything which is left to be mentioned here but required for successful completion of the aforementioned subject work shall be done <b>Central Board of Irrigation and Power Malcha Marg Chanakyapuri, New Delhi-110021</b> 20. CBIP Delhi shall submit a report on detailed points in four sets of hard copy duly spiraled binding as well as soft copy shall be submitted. 21. The safety guidelines prevalent in PTCUL must be followed.
2	GST	:	GST shall be paid extra as per applicable Government rules.
3	Tax	:	Tax shall be deducted at source as per applicable Government rules. A certificate to this effect may be given to the Contractor if required.
4	Date of Start of work	:	Order shall be considered as having come in to force from the date of issue of order.
5	Supply Completion	:	NA
6	Work completion	:	The work should be completed within 24 months from the date of issue of order.
7	Engineer of the contract		Superintending Engineer (T&C), Haldwani is the "Engineer of the contract" who shall be placing the order for the work with the contractor and signing the contract agreement and who has been inherently vested with such powers by corporation in this behalf and shall act as Engineer for the purpose of the contract.
8	Engineer in-charge		Respective Executive Engineer (T&C) shall be "Engineer in charge" for the subject work.
9	Liquidity damages	:	If the contract is delayed beyond the stipulated period mentioned in the contract. The liquidity damages shall be levied @ 0.5 % per week and maximum up to 10% of contract value.
10	Dispute		All Dispute arising out of this case under the jurisdiction local court at Kashipur and Honable High Court, Nainital.
11	Payment terms	:	1. 25% Payment will be made within 30 days after finalization of Audit plan, subject to availability of funds from PTCUL HQ. 2. 35% Payment will be made within 30 days after submission of preliminary reports verified by Executive Engineer of respective division, subject to availability of funds from PTCUL HQ. 3. 40 % Payment will be made within 30 days after submission of final reports verified by Executive Engineer of respective division, subject to availability of funds from PTCUL HQ.
12	Payment unit		Test & Commissioning Division, Kashipur shall be the payment unit and all units where is to be work done shall record the measurement and duly passed bills along with measurement book shall be submitted to payment unit.
13	Warranty period	:	NA.
14	Billing Address	:	Executive Engineer Test & Commissioning Division, PTCUL 400 KV Substation Campus, Kashipur (Uttarakhand)-244713, GSTIN No. (05AAECM1785FC29)

All other term and condition of this order shall be governed by the General conditions of the contract prevalent in PTCUL.

(D.P Singh)

Superintending Engineer(T&C), Haldwani

मुख्यालय एवंपंजीकृत कार्यालय:-विद्युतमवन, नजदीक-आई०एस०बी०टी० क्रासिंग, सहारनपुररोड, गाजरा, देहरादून-248002  
कारपोरेटआईडी नं०: U40101UR2004GOI028675 दरमारा नं० 0135-2646000 फ़ैक्स नं० 0135-2643460 वेबसाइटwww.ptcul.org



पावर ट्रांसमिशन कारपोरेशन ऑफ उत्तराखण्ड लि०  
(उत्तराखण्ड सरकार का उपक्रम)  
अधीक्षण अभियन्ता (परीक्षण एवं परिचालन एवं स्काडा) कार्यालय  
कुमायु मण्डल हल्द्वानी  
मोबाइल नं० 9412089275, ईमेल dp\_singh@ptcul.org

No. 394 /SE (T&C)/PTCUL/ (H)/

Date:26.10.2023

Subject:- Corrigendum for the Order for the work of Protection Audit of 02 Nos 400 kV and 08 Nos 220KV sub-stations in

PTCUL

Joint Advisor

Central Board of Irrigation and Power

Malcha Marg Chanakyapuri,

New Delhi-110021

Email: mrchauhan@cbip.org.

Dear Sir,

In reference to above mentioned subject, please refer to kick off meeting held on dated 26.10.2023 for the work of Protection Audit of 02 Nos 400 kV and 08 Nos 220KV sub-stations in PTCUL against order no.376 dated 29.09.2023.

In this regard, kindly find enclosed herewith corrigendum of order no.376 dated 29.09.2023 (Annexure-1) with necessary amendments as discussed in afforementioned meeting.

This is for your kind information and necessary action.

Please acknowledge the receipt and acceptance of order.

(D.P Singh)

Superintending Engineer (T&C), Haldwani

Copy forwarded to the following for information and necessary action:-

1. Chief Engineer, T&C PTCUL, 132kV Substation Campus, Kathgodam Nainital..
2. Executive Engineer, T&C Division, Roorkee/Dehradun/Haldwani/Kashipur/Rishikesh with request to provide assistance and information to CBIP for the above work.
3. Director (Energy), Central Board of Irrigation and Power Malcha Marg Chanakyapuri, New Delhi-110021  
Email: [sanjeev@cbip.org](mailto:sanjeev@cbip.org)

मुख्यालय एवंपंजीकृत कार्यालय:-विद्युतमवन, नजदीक-आई०एस०बी०टी० क्रॉसिंग, सहारनपुररोड, माजरा, देहरादून-248002  
कारपोरेटआईडी नं०: U40101UR2004GOI028675 दूरभाष नं० 0135-2646000 फॅक्स नं० 0135-2643460 वेबसाइट [www.ptcul.org](http://www.ptcul.org)

Annexure -1 – Work order corrigendum

Scope: The detailed Scope work is as under:

S. No.	Clause of PO	Existing Clause					Modified Clause						
		Sr. No	Description	Unit	Qty	Amount	Total Amount	Sr. No	Description	Unit	Qty	Unit rate (Rs.)	Total Amount (Rs.)
1	Price Schedule	1	Protection Audit to be carried out for the following 10 nos. of the 400/220kV substations of PTCUL - 1. 400kV S/s Rishikesh 2. 400 KV S/s Kashipur 3. 220kV S/s Chamba 4. 220kV S/s Rishikesh 5. 220kV S/s Roorkee 6. 220kV S/s Haridwar (SIDCUL) 7. 220kV S/s Jhajra 8. 220 KV S/s Pantnagar 9. 220 KV S/s Haldwani 10. 220kV S/s Mahaukhergani. TOTAL	Job	1	36,25,000	36,25,000	1	Protection Audit to be carried out for the following 10 nos of the 400/220kV substations of PTCUL - 1. 400kV S/s Rishikesh 2. 400 KV S/s Kashipur 3. 220kV S/s Chamba 4. 220kV S/s Rishikesh 5. 220kV S/s Roorkee 6. 220kV S/s Haridwar (SIDCUL) 7. 220kV S/s Jhajra 8. 220 KV S/s Pantnagar 9. 220 KV S/s Haldwani 10. 220kV S/s Mahaukhergani) TOTAL	Each	10	3,62,500	36,25,000
2	Terms and Conditions S. No. 1 – Scope	<ol style="list-style-type: none"> <li>There must be a kick off meeting for discussion on project plan before start of the work in field and the detailed plan of performance shall be submitted by CBIP.</li> <li>Requisite data shall be collected in standard format from PTCUL grid substations by authorized and experienced auditor.</li> <li>The site surveys and audit of grid substations of PTCUL shall be done by authorized and experienced auditor.</li> <li>Review of the implemented protection schemes/ philosophy for 400/220 kV substations which includes protection of transmission lines, interconnecting lines, interconnecting transformers, line/bus reactors, bus bar, bus couplers etc with respect to</li> </ol>					<ol style="list-style-type: none"> <li>There must be a kick off meeting for discussion on project plan before start of the work in field and the detailed plan of performance shall be submitted by CBIP.</li> <li>Requisite data shall be collected in standard format from PTCUL grid substations by an experienced auditor.</li> <li>The site surveys and audit of grid substations of PTCUL shall be done by an experienced auditor.</li> <li>Review of the implemented protection schemes/philosophy for 400/220 kV substations which includes protection of transmission lines, interconnecting transformers, line/bus reactors, bus bar, bus couplers etc with respect to</li> </ol>						









S. No.	Clause of PO	Existing Clause	Modified Clause
		couplers etc.as per latest guidelines of Ramakrishna committee/CBIP/NRPC/international best practices, etc.	tripping in last one year as per latest guidelines of Ramakrishna committee/CBIP/NRPC/international best practices, which includes review of the following:
5.	Review the adequacy of primary and backup protection settings for protected equipment and suggest corrective measures where everyone compliance with respect to Ramakrishna committee/ CBIP/NRPC is found during the protection audit.	Review the healthiness/adequacy of 220/110/50V DC system available at substations for protection application.	a) Adequacy of primary and backup protection settings for protected equipment and suggest corrective measures b) Availability/healthiness of PLCC communication links used for protection systems.
6.	Review of availability/healthiness of PLCC communication links used for protection systems.	Review the healthiness/adequacy of 220/110/50V DC system available at substations for protection application.	c) Healthiness/adequacy of 220/110/50V DC system available at substations for protection application.
7.	Review of availability/healthiness of GPS system and time synchronization facility used for protection.	Review of availability/healthiness of recording instruments like DRs /ELs for transmission lines protection.	d) Availability/healthiness of GPS system and time synchronization facility used for protection.
8.	Review of availability/healthiness of recording instruments like DRs /ELs for transmission lines protection.	Review of test reports for assessing the healthiness of circuit breakers, CT & CVT based upon available test reports at sites.	e) Availability/healthiness of recording instruments like DRs /ELs for transmission lines protection.
9.	Review of test reports for assessing the healthiness of circuit breakers, CT & CVT based upon available test reports at sites.	Field inspection of protection device for obsolescence of technology, suitability and healthiness.	f) Test reports for assessing the healthiness of circuit breakers, CT & CVT based upon available test reports at sites.
10.	Field inspection of protection device for obsolescence of technology, suitability and healthiness.	Prepare recommendation for replacement of obsolescence relays with compatible numerical relays will be provided.	g) Field inspection of protection device for obsolescence of technology, suitability and healthiness.
11.	Directory of the protection system & recommendation for replacement of obsolescence relays with compatible numerical relays will be provided.	Checking of availability of DG Set/auxiliary DC supply at substations.	h) Prepare recommendation for replacement of obsolescence relays with compatible numerical relays will be provided.
12.	Checking of availability of DG Set/auxiliary DC supply at substations.	Site visits for onsite protection audit, review and inspection of substations will be performed.	i) Checking of availability of DG Set / auxiliary DC supply at substations.
13.	Site visits for onsite protection audit, review and inspection of substations will be performed.	Submission of the detailed report for the protection audit including the protection philosophy, reviewed settings and protection audit observations.	5. Site visits for onsite protection audit, review and inspection of substations will be performed
14.	Submission of the detailed report for the protection audit including the protection philosophy, reviewed settings and protection audit observations.	The performance of above protection equipment like relays, circuit breaker, CT, CVT, DC battery bank, synchro facility, communication facility used for protection will be also checked through physical inspection and provided test reports/documents. These protection equipment's will be recommended for renovation and upgradation based on their performance accessed during protection audit and physical inspection.	6. Submission of the detailed report for the protection audit including the protection philosophy, reviewed settings and protection audit observations.
15.	The performance of above protection equipment like relays, circuit breaker, CT, CVT, DC battery bank, synchro facility, communication facility used for protection will be also checked through physical inspection and provided test reports/documents. These protection equipment's will be recommended for renovation and upgradation based on their performance accessed during protection audit and physical inspection.		Deleted as it is covered in point 4 above.









S. No.	Clause of PO	Existing Clause	Modified Clause
		<p>17. Review the availability healthiness of</p> <ul style="list-style-type: none"> <li>• Event recorders/ loggers' operation history</li> <li>• CT, CVT, CB</li> <li>• DC power supply</li> <li>• Auxiliary supply</li> <li>• Communication links</li> <li>• Time synchronization/ GPS</li> </ul> <p>18. Review of Testing and Maintenance records of all protective relays, Circuit Breakers, CT, CVT etc. Review of protection philosophy.</p> <p>19. Anything which is left to be mentioned here but required for successful completion of the aforementioned subject work shall be done Central Board of Irrigation and Power Malcha Marg Chanakyapuri, New Delhi-110021</p> <p>20. CBIP Delhi shall submit a report on detailed points in four sets of hard copy duly spiraled binding as well as soft copy shall be submitted.</p> <p>21. The safety guidelines prevalent in PTCUL must be followed.</p>	<p>7. Anything which is left to be mentioned here but required for successful completion of the aforementioned subject work shall be done by Central Board of Irrigation and Power.</p> <p>8. CBIP Delhi shall submit a protection report on detailed points in four sets of hard copy duly spiraled binding and in soft copy as well.</p> <p>9. The safety guidelines prevalent in PTCUL must be followed.</p>
3	Terms and Conditions – S. No. 6 - Work Completion	<p>The work should be completed within 24 months from the date of issue of order</p>	<p>The work should be completed within 24 weeks from the date of issue of corrigendum.</p>
4	Terms and Conditions – S. No. 8 - Engineer-in-charge	<p>Respective Executive Engineer (T&amp;C) shall be "Engineer in charge" for the subject work.</p>	<p>The following Executive Engineers (T&amp;C) shall be "Engineer in charge" for the subject work:</p> <p>a) 400KV Rishikesh, 220KV Rishikesh, 220 KV Chamba – Mr. Harsh Verma (Ph. No.9412074038 &amp; Email: ee_tandc_sh@ptcul.org).</p> <p>b) 400KV Kashipur, 220KV Pantnagar, 220KV Haldwani &amp; 220KV Mahuakheragan] – Mr. Asim Baig (Ph. No. 9412087885 &amp; Email: ee_tandc_asp@ptcul.org).</p> <p>c) 220KV SIDCUL Haridwar, 220 kv Roorkee – Mr. Ashwini Kumar (Ph. No.7088117301 &amp; Email: ee_tandc_ake@ptcul.org).</p> <p>d) 220KV Jhajra – Mr. Ravindra Kumar (Ph. No. 9927744222 &amp; Email: ee_tandc_ddun@ptcul.org).</p>



S. No.	Clause of PO	Existing Clause	Modified Clause
5	Terms and Conditions - S. No. 11 - Payment Terms	<ol style="list-style-type: none"> <li>1. 25% Payment will be made within 30 days after finalization of Audit plan, subject to availability of funds from PTCUL HQ.</li> <li>2. 35% Payment will be made within 30 days after submission of preliminary reports verified by Executive Engineer of respective division, subject to availability of funds from PTCUL HQ.</li> <li>3. 40 % Payment will be made within 30 days after submission of final reports verified by Executive Engineer of respective division, subject to availability of funds from PTCUL HQ.</li> </ol>	<ol style="list-style-type: none"> <li>1. 25% Payment will be made within 30 days after finalization of Audit plan, subject to availability of funds from PTCUL HQ.</li> <li>2. 35% Payment will be made within 30 days after submission of preliminary reports <b>on prorata basis</b> verified by Executive Engineer of respective division, subject to availability of funds from PTCUL HQ.</li> <li>3. 40 % Payment will be made within 30 days after submission of final reports <b>on prorata basis</b> verified by Executive Engineer of respective division, subject to availability of funds from PTCUL HQ.</li> <li>4. The local travel, lodging &amp; boarding shall be arranged by PTCUL on free-of-cost basis for CBIP team visiting the substation</li> </ol>







## **Annexure – 8: Data Sheets**

# Contents

<b>Single Line Diagrams</b> .....	59
<i>Substation Single Line Diagram</i> .....	59
<i>AC Auxiliary System</i> .....	60
<i>DC Auxiliary System</i> .....	61
<b>Transmission Lines</b> .....	63
<b>Bus-Bar Protection</b> .....	66
<b>AC Auxiliary System</b> .....	67
<b>DC Auxiliary System</b> .....	68
<b>Circuit Breakers</b> .....	69
<b>Current Transformer</b> .....	70
<b>Capacitive Voltage Transformer/Potential Transformer</b> .....	73
<b>Disturbance Recorder (DR) &amp; Event Logger (EL)</b> .....	76
<b>Communication System</b> .....	77
<b>Transformer Protection</b> .....	78
<b>Network Diagram of Uttarakhand</b> .....	81
<b>Power Map of Uttarakhand</b> .....	82

# Protection Audit of 220/132KV SIDCUL Substation

## Annexure - 8

### Data Sheets

## Single Line Diagrams

### Substation Single Line Diagram

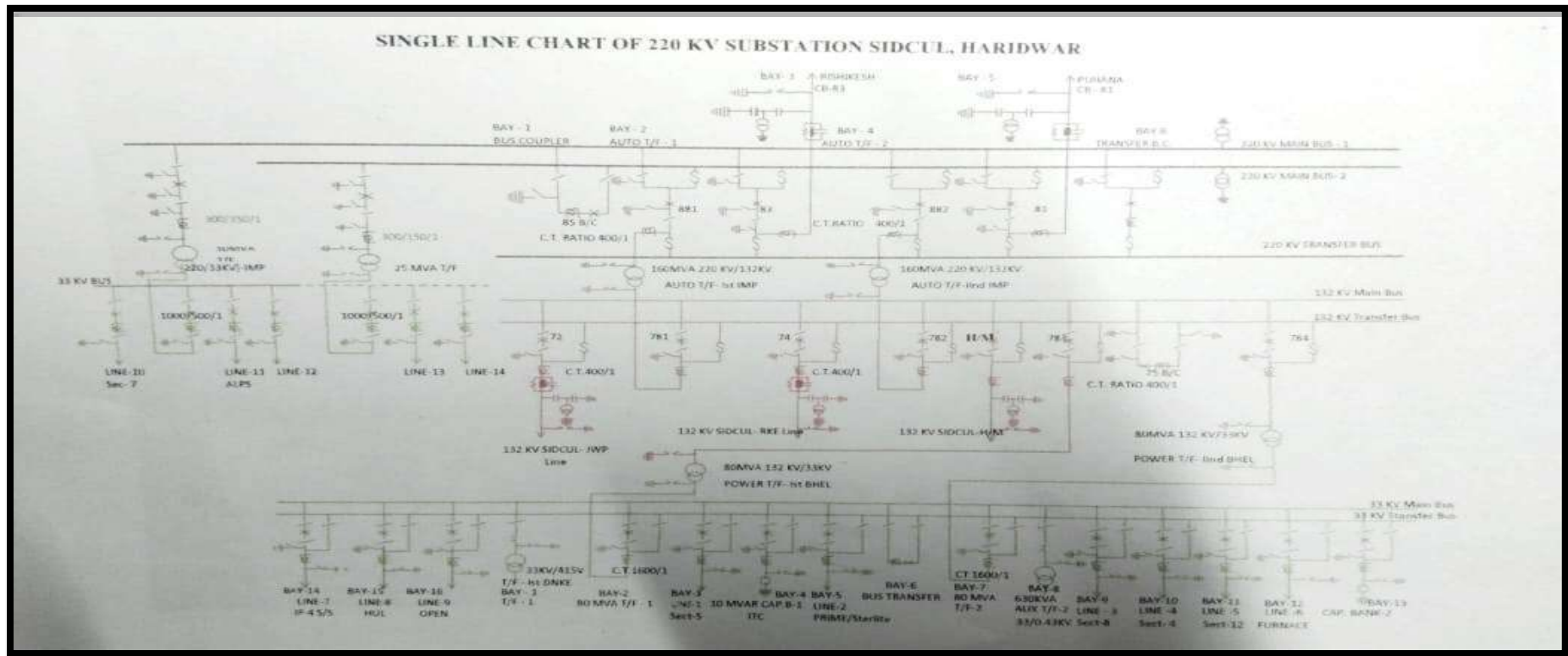

*AC Auxiliary System*

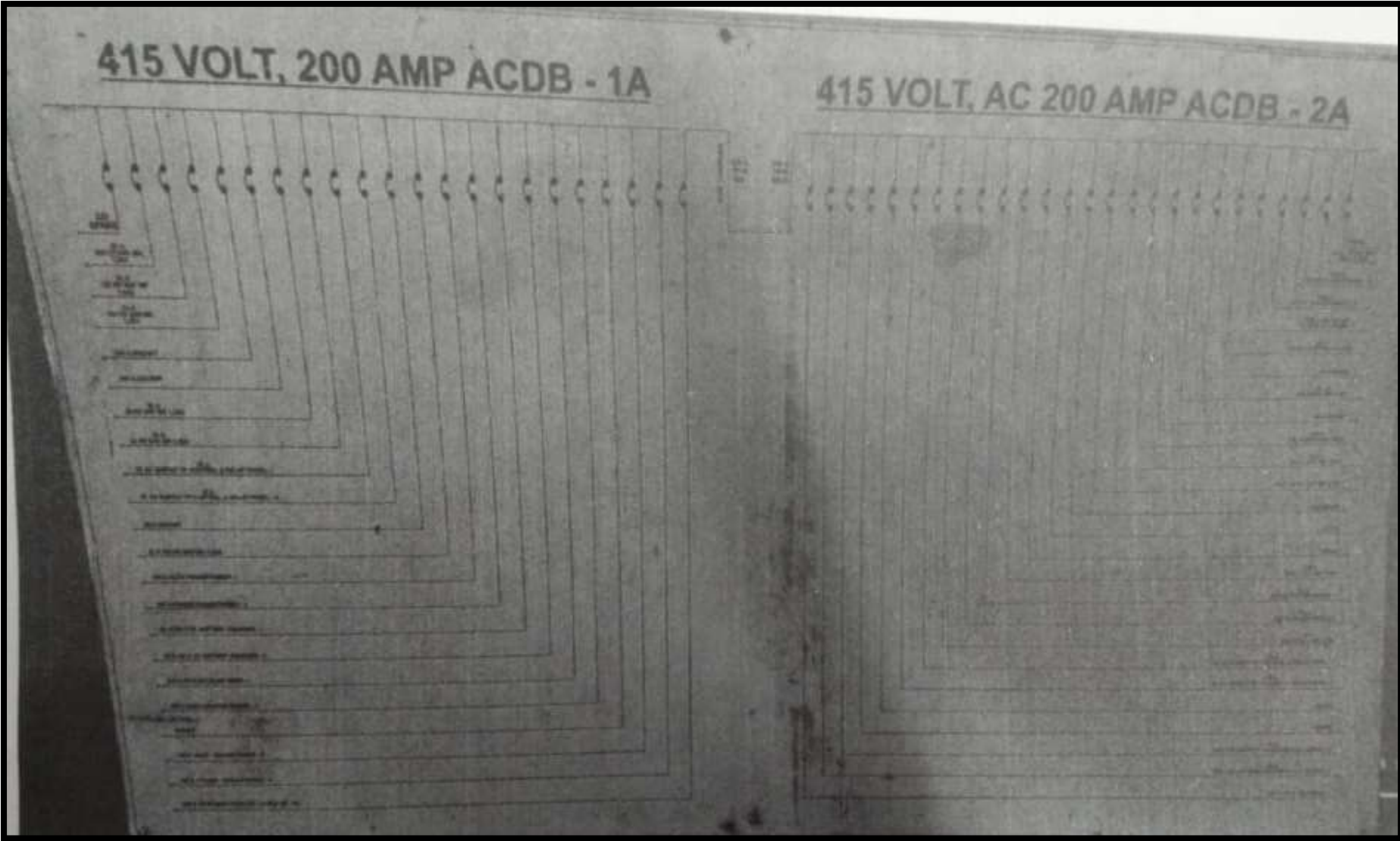



*DC Auxiliary System*

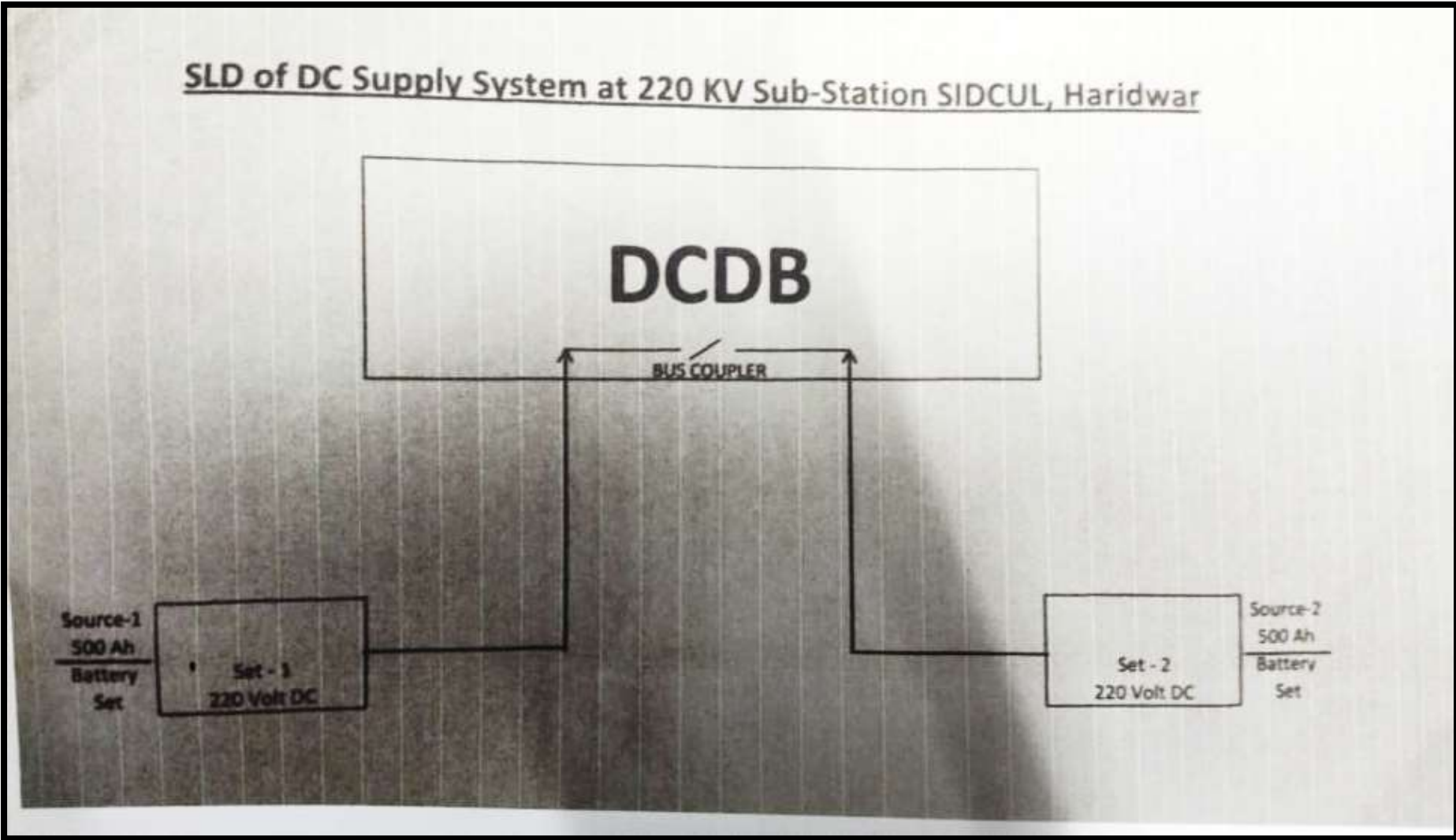

*SAS Architecture diagram*

**Not Available**



## Transmission Lines

220kV:

Particulars		Tr Line 1	Tr Line 2
Name of Tr Line		220 Imlikheda	220 Rishikesh
Length of Line		18.94	23.98
Series Compensated (Yes/No)		No	No
Connected to dedicated CT core (mention name)		Yes, PS	Yes, PS
CT Ratio		1600-800/1	1600-800/1
Connected to dedicated PT core (mention name)		Yes, 3P	Yes, 3P
PT Ratio		220KV/110V	220KV/110V
Relay connected to Trip Coil-1 or 2 or both		Both	Both
Feed from DC supply-1 or 2		1	1
i	Main-I Protection (Make and Model)	Schneider P545	Schneider P545
	Functional (Yes/No)	Yes	Yes
	Date of testing		
ii	Main-II Protection (Make and Model)	NA	NA
	Functional (Yes/No)	NA	NA
	Date of testing	NA	NA

Particulars		Tr Line 1	Tr Line 2
iii	LBB Protection (Make and Model)	NA	NA
	Functional (Yes/No)	NA	NA
	Date of testing	NA	NA
iv	PLCC/ Protection coupler (Make and Model)	NA	NA
	Functional (Yes/No)	NA	NA
v	DR (Make &Model) (Make and Model)	NA	NA
	Functional (Yes/No)	NA	NA
iv	Time Synch.Unit (Make and Model)	NA	NA
	Functional (Yes/No)	NA	NA
Other Protections			
1	Status of Power Swing	Block in Zone 1	Block in Zone 1
2	Out of Step	NA	NA
3	SOTF	NA	NA
4	Breaker Failure	Yes	Yes
5	Broken Conductor	No	No
6	STUB	No	No
7	Fault Locator	Yes	Yes
8	Disturbance Recorder	Yes	Yes
9	VT fuse fail	Yes	Yes
10	Overvoltage Protection	No	No

<b>Particulars</b>		<b>Tr Line 1</b>	<b>Tr Line 2</b>
11	Trip Circuit supervision	Yes	Yes
12	Auto-reclose	Yes	Yes
13	Load encroachment	No	No

## Bus-Bar Protection

### Bus-Bar Protection:

220kV

Sl. No.	Particulars	Observations
a	Busbar and redundant relay make and model	Electromechanical bus bar protection
b	Type of Busbar arrangement	Main 1-2 & Transfer
c	Zones	Three
d	Dedicated CT core for each busbar protection	Yes
e	Breaker Failure relay included, if additional then furnish make and model	NA
f	Trip issued to both Busbar protection in case of enabling	NA
g	Isolator indication and check relays	NA
h	Other requirements for protection checking and validation	NA

## AC Auxiliary System

Sl. No.	Particulars	Observations
a	Source of AC auxiliary system	01 No. 630 kVA 33/0.4 kV
b	Supply changeover between sources (Auto/Manual)	Auto
c	Diesel generator (DG) details	50 KVA
d	Maintenance plan and supply changeover periodicity in DG	
e	Single Line Diagram	
f	Other requirements for protection checking and validation	

## DC Auxiliary System

Sl. No.	Particulars	Observations			
		220 V DC - I	220 V DC - II	48 V DC-I	48 V DC-II
a	Make	NA	NA	NA	NA
b	Model/Rating	NA	NA	NA	NA
c	Vintage	3 Year	9 Year	6 Year	18 Year
d	Measured voltage				
	i. Positive to Earth	199 V	199 V	0 V	NA
	ii. Negative to Earth	42 V	42 V	47 V	NA
e	No. of Cells Per Bank	110	110	24	24
f	Availability of Battery Charger	Yes	Yes	Yes	yes

## Circuit Breakers

	Particulars	Make and Model	No. of trip/close coil	Trip Coil Supervision relay and healthiness of coils	LBB Setting Stage 1	LBB Setting Stage 2	Remarks (If any)
A	<b>220kV System</b>						
1	220 kV SIDCUL-RKSH	CGL, type-200-SFM-40S	6/3	Healthy		NA	
2	220kV SIDCUL-PIRANKALIYAR	CGL, type-200-SFM-50AA	6/3	Healthy		NA	
3	160 MVA ICT-1	CGL, type-200-SFM-50AA	6/3	Healthy		NA	
4	160 MVA ICT-2	CGL, type-200-SFM-50AA	6/3	Healthy		NA	
5	50 MVA	ABB, LTB245E1, 40KA	6/3	Healthy		NA	
6	25 MVA	CGL, type-200-SFM-50AA	6/3	Healthy		NA	

## Current Transformer

a	Location of CT	<b>220 KV SIDCUL-RKSH</b>				
b	Date of CT ratio Test Testing					
		Core I	Core II	Core III	Core IV	Core V
c	Accuracy Class	PS	PS	0.2	PS	PS
d	Purpose	MAIN	Back up	Metering	Protection	Protection
e	Test Results					
i	Ratio Adopted	1600-800/1	1600-800/1	1600-800/1	1600-800/1	1600-800/1
ii	Ratio measured	NA	NA	NA	NA	NA

a	Location of CT	<b>220 KV SIDCUL-PIRANKALIYAR</b>				
b	Date of CT ratio Test Testing					
		Core I	Core II	Core III	Core IV	Core V
c	Accuracy Class	PS	PS	0.2	PS	PS
d	Purpose	MAIN	Back up	Metering	Protection	Protection
e	Test Results					
i	Ratio Adopted	1600-800/1	1600-800/1	1600-800/1	1600-800/1	1600-800/1
ii	Ratio measured	NA	NA	NA	NA	NA



a	<b>Location of CT</b>	<b>160 MVA-I</b>				
b	Date of CT ratio Test Testing					
		Core I	Core II	Core III	Core IV	Core V
c	Accuracy Class	PS	PS	0.2	PS	PS
d	Purpose	MAIN	Back up	Metering	Protection	Protection
e	Test Results					
i	Ratio Adopted	1600-400/1	1600-400/1	1600-400/1	1600-400/1	1600-400/1
ii	Ratio measured	NA	NA	NA	NA	NA

a	<b>Location of CT</b>	<b>160 MVA-II</b>				
b	Date of CT ratio Test Testing					
		Core I	Core II	Core III	Core IV	Core V
c	Accuracy Class	PS	PS	0.2	PS	PS
d	Purpose	MAIN	Back up	Metering	Protection	Protection
e	Test Results					
i	Ratio Adopted	1600-400/1	1600-400/1	1600-400/1	1600-400/1	1600-400/1
ii	Ratio measured	NA	NA	NA	NA	NA

a	<b>Location of CT</b>	<b>50 MVA</b>				
b	Date of CT ratio Test Testing					
		Core I	Core II	Core III	Core IV	Core V
c	Accuracy Class	PS	PS	0.2	PS	PS
d	Purpose	MAIN	Back up	Metering	Protection	Protection
e	Test Results					
i	Ratio Adopted	1600-300/1	1600-300/1	1600-300/1	1600-300/1	1600-300/1
ii	Ratio measured	NA	NA	NA	NA	NA

a	<b>Location of CT</b>	<b>25 MVA</b>				
b	Date of CT ratio Test Testing					
		Core I	Core II	Core III	Core IV	Core V
c	Accuracy Class	PS	PS	0.2	PS	PS
d	Purpose	MAIN	Back up	Metering	Protection	Protection
e	Test Results					
i	Ratio Adopted	150-75/1	150-75/1	150-75/1	150-75/1	150-75/1
ii	Ratio measured	NA	NA	NA	NA	NA

## Capacitive Voltage Transformer/Potential Transformer

a	<b>Location of CT</b>	<b>220 KV SIDCUL-RKSH</b>				
b	Date of CT ratio Test Testing					
		Core I	Core II	Core III	Core IV	Core V
c	Accuracy Class	PS	PS	0.2	PS	PS
d	Purpose	MAIN	Back up	Metering	Protection	Protection
e	Test Results					
i	Ratio Adopted	1600-800/1	1600-800/1	1600-800/1	1600-800/1	1600-800/1
ii	Ratio measured	NA	NA	NA	NA	NA

a	<b>Location of CT</b>	<b>220 KV SIDCUL-PIRANKALIYAR</b>				
b	Date of CT ratio Test Testing					
		Core I	Core II	Core III	Core IV	Core V
c	Accuracy Class	PS	PS	0.2	PS	PS
d	Purpose	MAIN	Back up	Metering	Protection	Protection
e	Test Results					
i	Ratio Adopted	1600-800/1	1600-800/1	1600-800/1	1600-800/1	1600-800/1
ii	Ratio measured	NA	NA	NA	NA	NA

a	<b>Location of CT</b>	<b>160 MVA-I</b>				
b	Date of CT ratio Test Testing					
		Core I	Core II	Core III	Core IV	Core V
c	Accuracy Class	PS	PS	0.2	PS	PS
d	Purpose	MAIN	Back up	Metering	Protection	Protection
e	Test Results					
i	Ratio Adopted	1600-400/1	1600-400/1	1600-400/1	1600-400/1	1600-400/1
ii	Ratio measured	NA	NA	NA	NA	NA

a	<b>Location of CT</b>	<b>160 MVA-II</b>				
b	Date of CT ratio Test Testing					
		Core I	Core II	Core III	Core IV	Core V
c	Accuracy Class	PS	PS	0.2	PS	PS
d	Purpose	MAIN	Back up	Metering	Protection	Protection
e	Test Results					
i	Ratio Adopted	1600-400/1	1600-400/1	1600-400/1	1600-400/1	1600-400/1
ii	Ratio measured					

a	<b>Location of CT</b>	<b>50 MVA</b>				
b	Date of CT ratio Test Testing					
		Core I	Core II	Core III	Core IV	Core V
c	Accuracy Class	PS	PS	0.2	PS	PS
d	Purpose	MAIN	Back up	Metering	Protection	Protection
e	Test Results					
i	Ratio Adopted	1600-300/1	1600-300/1	1600-300/1	1600-300/1	1600-300/1
ii	Ratio measured	NA	NA	NA	NA	NA

a	<b>Location of CT</b>	<b>25 MVA</b>				
b	Date of CT ratio Test Testing					
		Core I	Core II	Core III	Core IV	Core V
c	Accuracy Class	PS	PS	0.2	PS	PS
d	Purpose	MAIN	Back up	Metering	Protection	Protection
e	Test Results					
i	Ratio Adopted	150-75/1	150-75/1	150-75/1	150-75/1	150-75/1
ii	Ratio measured					

## Disturbance Recorder (DR) & Event Logger (EL)

Sl. No.	Particulars	220kV	132kV
1	a) Is the Disturbance recorder and Fault locator provided on all line feeders?	Yes	Yes
	b) Whether standalone or built in Main relay	Built in	Built in
	c) Whether DR is having automatic fault record download facility to a central PC	No	No
	d) Whether Central PC for DR, EL are powered by Inverter (fed from station DC)	Yes	Yes
2	Whether substation is having Event logger facility	Yes	Yes
	If Yes (standalone or built-in-SAS)	Built in	Built in
3	Whether GPS based time synchronizing equipment is provided at the substation for time synchronizing of Main relays / DR/ Event logger / SAS/ PMU / Line Current Differential Relays	Yes	

# Communication System

**Not Available**

## Transformer Protection

Particulars	TF-1	TF-2	TF-3	TF-4
Name of ICT	160 MVA I	160 MVA II	50 MVA	25 MVA
Make	IMP	IMP		
Connected to dedicated CT core (HV Bay)				
Core-1	Protection	Protection	Protection	Protection
Core-2	Protection	Protection	Protection	Protection
Core-3	Metering	Metering	Metering	Metering
Core-4	Protection	Protection	Not in use	Not in use
Core-5	Protection	Protection	Not in use	Not in use
CT ratio	1600-400/1	1600-400/1	1600-300/1	150-75/1
Connected to dedicated Bus CVT core (HV Bay)				
Core-1	Protection	Protection	Protection	Protection
Core-2	Protection	Protection	Protection	Protection
Core-3	Metering	Metering	Metering	Metering
CVT ratio	220 KV/110V	220 KV/110V	220 KV/110V	220 KV/110V
Relay connected to Trip Coil-1 or 2 or both (HV)	Both	Both	Both	Both
Feed from DC supply-1 or 2(LV)	Both	Both	Both	Both
Connected to dedicated CT core (LV Bay)				
Core-1	Protection	Protection	Protection	Protection
Core-2	Protection	Protection	Protection	Protection



Particulars		TF-1	TF-2	TF-3	TF-4
Core-3		Metering	Metering	Metering	Metering
Core-4		Protection	Protection	NA	NA
Core-5		Protection	Protection	NA	NA
CT ratio		1000-500/1 800-400/1	1000-500/1 800-400/1	1000-500/1	1000-500/1
Connected to dedicated Bus CVT core (LV Bay)					
Core-1		Protection	Protection	Protection	Protection
Core-2		Protection	Protection	Protection	Protection
Core-3		Metering	Metering	Metering	Metering
CVT ratio		132KV/110V	132KV/110V	33KV/110V	33KV/110V
Relay connected to Trip Coil-1 or 2 or both (HV)		Both	Both	Both	Both
Feed from DC supply-1 or 2(LV)		2	2	2	2
LA Rating/ HV Side		NA	NA	NA	NA
LA Rating/ LV Side		NA	NA	NA	NA
Date of last testing of Protection		NA	NA	NA	NA
Group A Protection					
1	Differential Protection (Make & Model)	ALSTOM P633	Schneider P643	GE T60	Schneider P643
2	PRV	YES	YES	YES	YES
3	WTI Indication working	YES	YES	YES	YES
4	Back-up Over Current Protection HV (Make & Model)	P127	P127	F650	F650

<b>Particulars</b>		<b>TF-1</b>	<b>TF-2</b>	<b>TF-3</b>	<b>TF-4</b>
5	Over Flux Protection (Make & Model) HV	NA	NA	NA	NA
Group B Protection					
1	REF Protection (Make & Model)	NA	NA	ALSTOM CAG14	ALSTOM P14NB
2	Bucholtz	YES	YES	YES	YES
3	Back-up Over Current Protection LV (Make & Model)	P127	P127	F650	F650
4	Over Flux Protection (Make & Model) LV	NA	NA	NA	NA
5	OTI Indication working	YES	YES	YES	YES

# Network Diagram of Uttarakhand

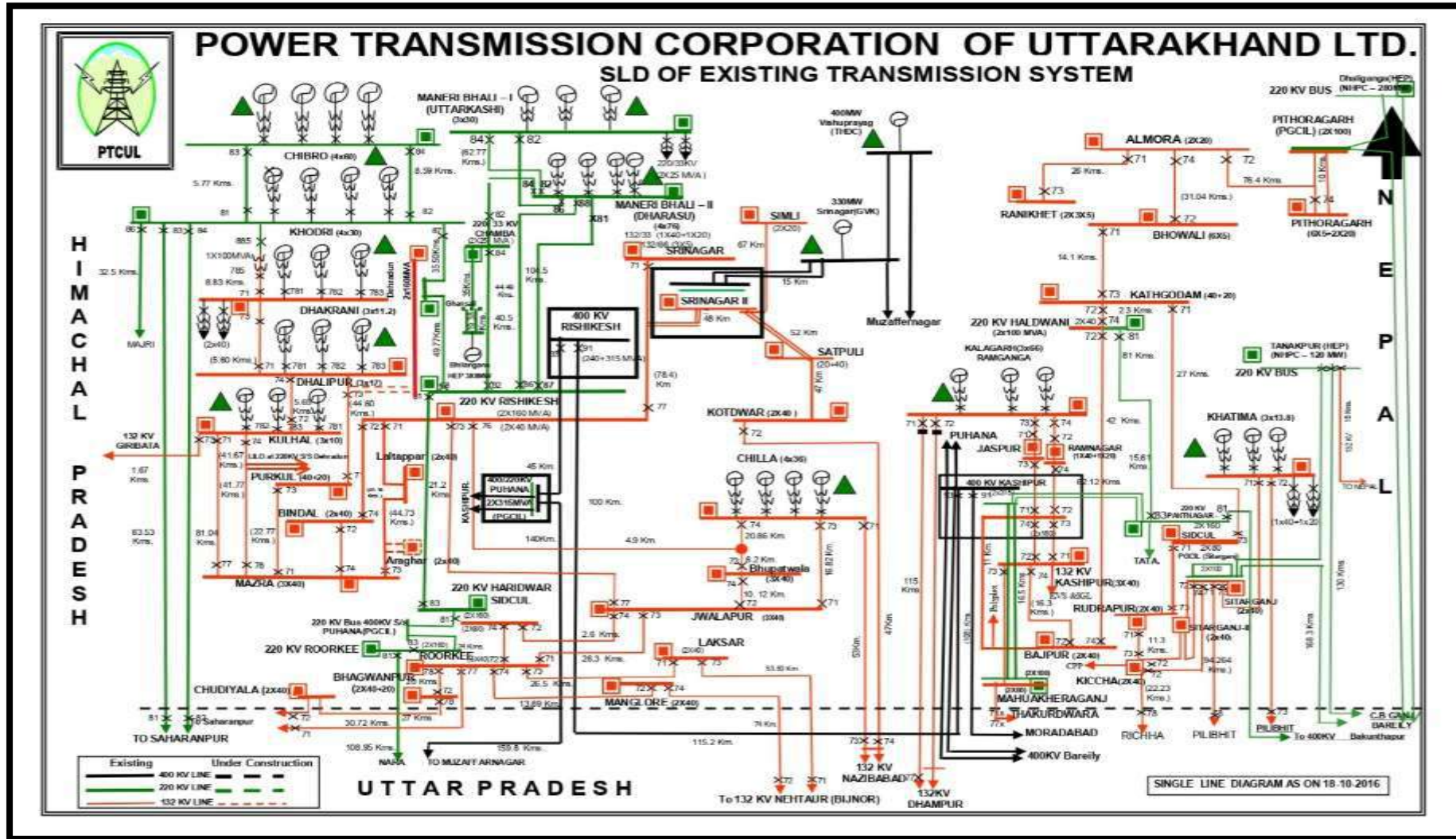

# Power Map of Uttarakhand

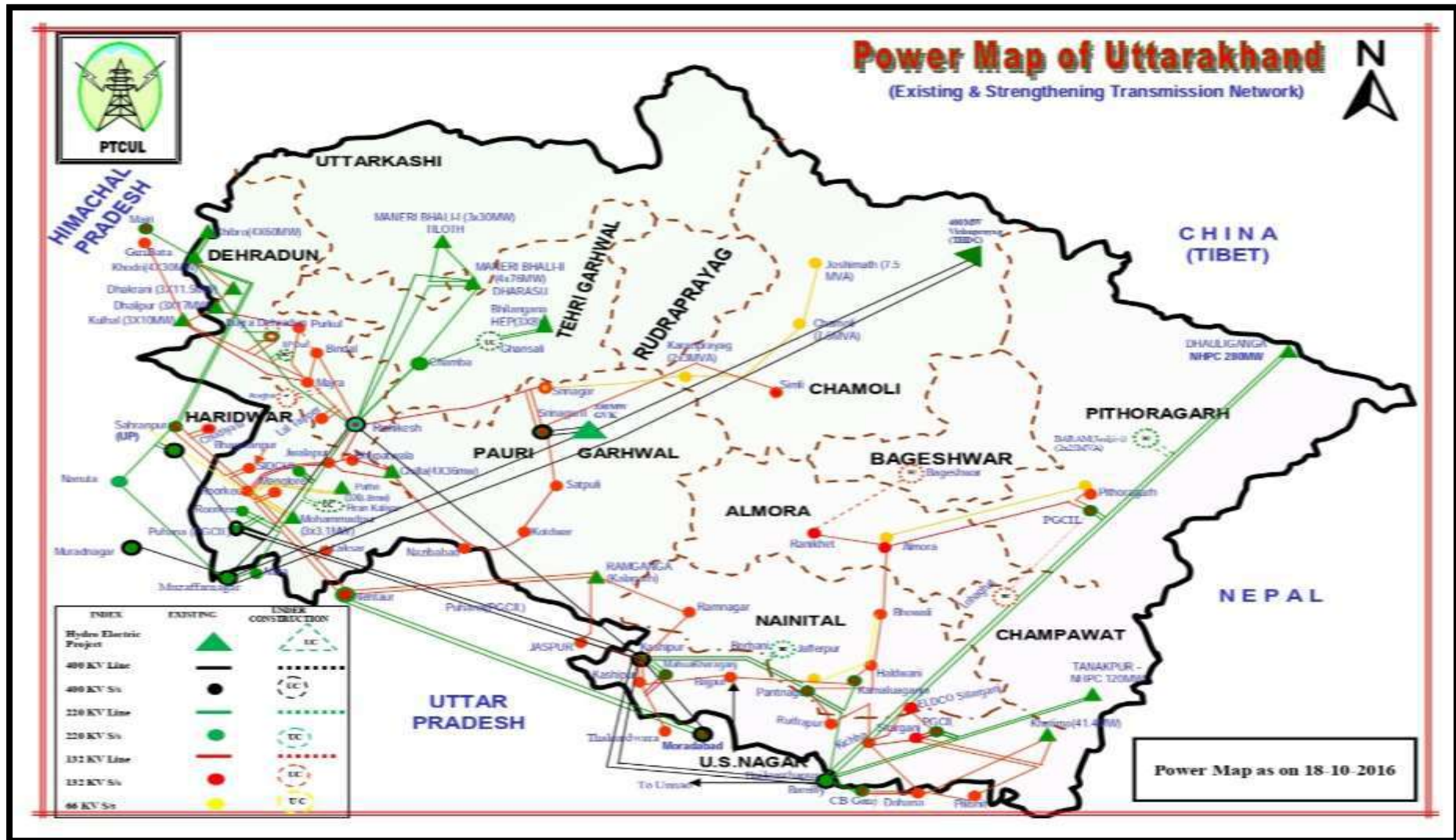



# **Power Transmission Corporation of Uttarakhand Limited**

(A Govt. of Uttarakhand Undertaking)

Corporate ID No.: U40101UR2004SGC028675

## **FINAL REPORT**

### **Protection Audit**

**220/132KV Roorkee Substation**

**Submitted**

**By**



**CENTRAL BOARD OF IRRIGATION & POWER**

**NEW DELHI**





# केन्द्रीय सिंचाई व शक्ति मंडल CENTRAL BOARD OF IRRIGATION AND POWER

25<sup>th</sup> June 2024

Order No.: 376/SE (T&C)/PTCUL/(H). dated: 29.09.2023

## Protection Audit Report

FINAL PROTECTION AUDIT REPORT OF 220/132KV ROORKEE SUBSTATION UNDER POWER TRANSMISSION CORPORATION OF UTTARAKHAND LIMITED (PTCUL), UTTARAKHAND.

Submitted  
To



**Power Transmission Corporation of Uttarakhand Limited**  
(A Govt. of Uttarakhand Undertaking)  
Corporate ID No.: U40101UR2004SGC028675

# Contents

<b>Disclaimer</b> .....	6
<b>1.0. Executive Summary</b> .....	7
<b>2.0. Introduction</b> .....	10
2.1. <i>Background</i> .....	10
2.2. <i>Scope of Work</i> .....	10
2.3. <i>Audit Rationale</i> .....	11
2.4. <i>Audit Process</i> .....	12
2.5. <i>About Power Transmission Corporation of Uttarakhand (PTCUL)</i> .....	14
2.6. <i>About Central Board of Irrigation &amp; Power (CBIP)</i> .....	15
<b>3.0. Preliminary Audit of 220/132KV Roorkee Substation</b> .....	16
3.1. <i>General Information about Substation</i> .....	16
3.2. <i>Audit Team</i> .....	16
3.3. <i>Recommendation of last protection checking and validation</i> .....	17
3.4. <i>Review of existing settings at substation</i> .....	21
3.5. <i>Disturbance Recorder availability for the last 6 tripping's</i> .....	21
3.6. <i>Chronic reason of tripping, if any</i> .....	22
3.7. <i>Major non-conformity/deficiency observed</i> .....	22
<b>4.0. List of Trippings</b> .....	24
<b>5.0. Observations and Recommendations</b> .....	47
5.1. <i>Reporting of all the Tripping with DR/EL</i> .....	47
5.2. <i>Development of centralized database of relay settings</i> .....	47
5.3. <i>Review of test results of relay and equipment</i> .....	48
5.4. <i>Availability of Testing Kits</i> .....	48
5.5. <i>Up-dation of PTCUL Protection Philosophy</i> .....	48
5.6. <i>Simulation based study of protection system</i> .....	49
5.7. <i>Capacity Building of protection team</i> .....	49
5.8. <i>Updated Fault Level/ Short Circuit Level and Network information</i> .....	49
5.9. <i>General Protection related observations</i> .....	49
5.10. <i>O&amp;M Manual</i> .....	49
<b>6.0. Station Specific Observation and Recommendations</b> .....	50
6.1. <i>Protection related observations and recommendations</i> .....	50
6.2. <i>Equipment related observations and recommendations</i> .....	50
6.3. <i>Auxiliary Equipment related observations and recommendations</i> .....	50
<b>Annexure – 1: Suggested List of Testing Instruments</b> .....	51
<b>Annexure – 2: Suggested List of Substation Equipments</b> .....	52

<b>Annexure – 3: Suggested List of Maintenance Equipments.....</b>	<b>53</b>
<b>Annexure – 4: Protection Code (IEGC 2023 Chapter 4).....</b>	<b>54</b>
<b>Annexure – 5: Third Party Protection System Checking &amp; Validation Template for a Substation (IEGC 2023 Annexure – 1).....</b>	<b>59</b>
<b>Annexure – 6: Protection Philosophy/Protocol of Northern Region .....</b>	<b>64</b>
<b>Annexure – 7: Work Order &amp; Corrigendum.....</b>	<b>70</b>
<b>Annexure – 8: Data Sheets .....</b>	<b>78</b>



## ACRONYMS

<b>A</b>	Ampere
<b>AC</b>	Alternating Current
<b>AMP</b>	Annual Maintenance Plan
<b>CBIP</b>	Central Board of Irrigation and Power
<b>CT</b>	Current Transformer
<b>CVT</b>	Capacitive Voltage Transformer
<b>DC</b>	Direct Current
<b>DG</b>	Diesel Generator
<b>DPR</b>	Detailed Project Report
<b>DR</b>	Disturbance Recorder
<b>EL</b>	Event Logger
<b>EMTP</b>	Electromagnetic Transient Program
<b>GPS</b>	Global Positioning System
<b>ICT</b>	Inter Connecting Transformer
<b>IEGC</b>	Indian Electricity Grid Code
<b>KA</b>	Kilo Ampere
<b>KV</b>	Kilo Volt
<b>LBB</b>	Local Breaker Backup
<b>LEFT</b>	Earth Fault
<b>MVA</b>	Mega Volt Ampere
<b>NA</b>	Not Available
<b>NRPC</b>	Northern Regional Power Committee
<b>O&amp;M</b>	Operation & Maintenance
<b>OCC</b>	Operation Coordination Sub Committee
<b>PLCC</b>	Power Line Carrier Communication
<b>PSC</b>	Power System Sub Committee
<b>PSDF</b>	Power System Development Fund
<b>PT</b>	Potential Transformer
<b>PTCUL</b>	Power Transmission Corporation of Uttarakhand Limited.
<b>RLDC</b>	Regional Load Dispatch Centre
<b>RPC</b>	Regional Power Committee

<b>SAS</b>	Substation Automation System
<b>SLD</b>	Single Line Diagram
<b>SLDC</b>	State Load Dispatch Centre
<b>SOTF</b>	Switch On-To Fault
<b>SPS</b>	Special Protection Scheme
<b>UJVNL</b>	Uttarakhand Jal Vidyut Nigam Ltd
<b>UPCL</b>	Uttarakhand Power Corporation Ltd
<b>WTI</b>	Winding Temperature Indicator

## Disclaimer

The protection audit has been carried out based on the guidelines provided under various documents mentioned in the report. For the purpose of audit, the auditor(s) have relied upon the data made available by the client and information & clarifications made available, in the written or verbal form, by the officials of clients during site visit and later.

The report is not for public distribution and has been furnished solely for information and must not be reproduced or redistributed to others, except those concerned. No one can use the report as a base for any claim, demand or cause of action and, also no one is responsible for any loss incurred based upon the content of this report.

While every effort is made to ensure the accuracy and completeness of information contained, CBIP takes no responsibility and assumes no liability for any error/ omission or accuracy of the information. Recipients of this material should rely on their own judgments and conclusions from relevant sources before taking any decision.

## 1.0. Executive Summary

PTCUL awarded the work of Third-Party Protection Audit of 2 nos. 400kV and 8 nos. 220kV substations of PTCUL (“Utility”) to CBIP. CBIP planned the audit as per Audit process provided under Protection Code within Indian Electricity Grid Code 2023. In addition, the guidelines of Ramakrishna Committee for checking and validation and NRPC guidelines for Third Party Audit were also adhered too. The CBIP manual on protection (manual no 247-Revised), NRPC protection philosophy were also referred too.

As a part of audit process, utility was asked to provide set of information before start of audit. Team from CBIP consisting of Mr. Vijay Barthwal, Mr. M.R. Chauhan, Mr. Shivam Gupta & Mr. Avichal Pandey visited 220/132KV Roorkee Substation during 23<sup>rd</sup> – 24<sup>th</sup> February 2024 and preliminary audit report was submitted on the spot. The representatives of utility were present during this process. Some more information was sought from the Utility.

Based on the data made available by Utility, draft of final report was submitted to Utility and after discussions, report was finalized. The details of audit process, data made available by Utility, observations from preliminary report and detailed observations and recommendations are provided in this report. Key observations and recommendations are summarized below under 2 heads.

### **General Observations and Recommendations for Utility scale implementation**

01. It is recommended that each substation to have a central repository for tripping reports, along with Time Synchronized DR/EL reports and analysis. A dedicated PC can be provided at each substation for the purpose.
02. The protection philosophy adopted by Utility, in general, is in alignment with protection philosophy adopted by NRPC. As the NRPC has recently updated the protection philosophy, PTCUL in consultation with SLDC may update protection philosophy for network not covered by NRPC too, if needed, and implement the same.
03. It is recommended that latest recommended relay settings, as per the NRPC protocol for 220KV & above Substations, along with setting calculations & parameters used for all the relays, be kept at each substation. This will help in proper fault analysis and ascertaining relay healthiness. Similarly, Relay settings for sub-stations below 220KV, based on any such protocol by SLDC, along with setting calculations and line parameters also needs to be maintained.
04. It is recommended that the detailed reports of test results for the relays and switchyard equipments be maintained at sub-station level.

05. Based on “Draft O&M Manual” of PTCUL and discussions with their officials, a list of testing equipment is suggested and enclosed at Point 5.4. It is recommended that the necessary testing equipment at substation/Sub-division/Division be arranged for regular testing of equipment at substations.
06. Simulation based studies or EMTP Studies should be carried out by the Utility, as per the requirement of IEGC.
07. For the protection system and SAS, PTCUL may undertake capacity building exercise for the officials involved in these activities.
08. It is recommended that the updated network information and short circuit level should be periodically reviewed and maintained at central level for revising the setting as per requirement.
09. It is suggested that utility may carry out exhaustive safety and technical audit of sub-stations apart from protection audit, either internally or thru’ third party for implementing the best practices in the sub-station. In addition, the existing draft O&M manual also be updated to take care of latest developments.

#### **Observations and Recommendations for 220/132/66 KV Roorkee Substation**

01. The Roorkee substation is internally divided into 2 parts. Old 132/66/33KV substation and new 220/132/66KV substation. The protection audit of new 220/132/66KV substation was carried out. The protection audit of this sub-station was recently on 11 Oct 2022 by NRPC/Power Grid Corporation. The few actions are initiated and compliance is pending so far. It is recommended to take necessary action for compliance and maintain record of the same.
02. Multiple high resistance earth faults are observed on 220KV Roorkee Nara line. It is suggested to analyse and take corrective actions during line maintenance.
03. 50 MVA 220/33KV Transformer tripping due to transient fault on 33 kV line were observed. It is recommended to take up protection co-ordination with distribution company (UPCL)
04. Bus Bar Protection on 220KV Bus is not functional after addition of the new elements with the 220KV bus. It is recommended to make it functional.
05. Auto reclosure on both the 220KV circuits is functional without carrier protection, due to unhealthy PLCC. It is recommended to keep record of successful auto-reclosures along with tripping reports.
06. The SAS has the event logging capability but is not in regular use. Also, some of the inputs are not available at SAS. It is recommended to keep SAS updated in regular use.

07. 3 nos. GPS Time Synchronization Systems are provided in the substation. However, presently no relays are time synchronised. It is recommended to take necessary corrective actions for time synchronization of all protective gear.
08. Both the 110V DC systems are showing earth-fault. It is recommended to take corrective actions to avoid any untoward tripping.
09. Necessary action for avoiding water logging and consequential maloperation of protective system needs to be taken.

## 2.0. Introduction

### 2.1. Background

The work has been awarded to the Central Board of Irrigation & Power (CBIP) vide Work Order Number: 376/SE (T&C)/PTCUL/(H), dated: 29.09.2023 for Protection Audit of 02 Nos. 400 kV and 08 Nos. 220 kV Sub-Station at Uttarakhand, for Power Transmission Corporation of Uttarakhand Limited (PTCUL) in reference to the offer submitted by CBIP to PTCUL vide ref. no. P-1/CBIP/PTCUL/Audit/2023, dated: 11.09.2023. A Kick-Off Meeting was held between PTCUL and CBIP at the office of SE (T&C), PTCUL, Kathgodam, Haldwani on 26<sup>th</sup> October 2023. Detailed discussions were held regarding process and methodology of Execution and Submission of reports of Protection Audit. As per the above-mentioned meeting, a corrigendum was released by PTCUL vide ref. no. 394/SE (T&C)/PTCUL/(H), dated: 26.10.2023.

**As per the given order, the protection audit of following sub-stations is to be carried out:**

1. *400kV Rishikesh*
2. *400kV Kashipur*
3. *220kV Chamba*
4. *220kV Rishikesh*
5. *220kV Roorkee*
6. *220kV Haridwar (SIDCUL)*
7. *220kV Jhajra*
8. *220kV Pantnagar*
9. *220kV Haldwani*
10. *220kV Mahuakheraganj*

### 2.2. Scope of Work

Review of the implemented protection schemes/philosophy for 400/220 kV substations which includes protection of transmission lines, interconnecting transformers, line/bus reactors, bus bar, bus couplers etc. with respect to tripping in last one year as per latest guidelines of Ramakrishna committee/ CBIP/NRPC/International best practices, which includes review of the following:

- a. *Adequacy of primary and backup protection settings for protected equipment and suggest corrective measures.*
- b. *Availability/healthiness of PLCC communication links used for protection systems.*
- c. *Healthiness/adequacy of 220/110/50V DC system available at substations for protection application.*
- d. *Availability/healthiness of GPS system and time synchronization facility used for protection.*
- e. *Availability/healthiness of recording instruments like DRs /ELs for transmission lines protection.*
- f. *Test reports for assessing the healthiness of circuit breakers, CT & CVT based upon available test reports at sites.*
- g. *Field inspection of protection device for obsolescence of technology, suitability and healthiness.*
- h. *Prepare recommendation for replacement of obsolescence relays with compatible numerical relays will be provided.*
- i. *Checking of availability of DG Set / auxiliary DC supply at substations.*

### **2.3. Audit Rationale**

- a. PTCUL (Utility) has submitted a DPR for Replacement of certain equipments under PSDF scheme to Grid-India. Grid-India has asked PTCUL to carry out protection audit of certain substations.
- b. In addition, as per CERC IEGC 2023 Chapter-04 (Protection Code) Para - 15 (2) “All users shall also conduct third party protection audit of each substation at 220KV and above (132KV and above in NER) once in 5 years or earlier as advised by the respective RPC”.
- c. As per Para – 15 (4) of said Code, “The third-party protection audit report shall contain information sought in the format enclosed as Annexure–1. The protection audit reports, along with action plan for rectification of deficiencies detected, if any, shall be submitted to the respective RPC and RLDC or SLDC, as the case may be, within a month of submission of third-party audit report. The necessary compliance to such protection audit report shall be followed up regularly in the respective RPC”.
- d. Subsequently NRPC issued protection philosophy for Northern region developed in compliance of IEGC 2023, Version 2.0 which was approved in 71<sup>st</sup> NRPC meeting held on 29.01.2024. Accordingly, protection audit of 220KV and above Substations is being carried out by CBIP, as per IEGC-2023 Annexure-1.



## 2.4. Audit Process

- PTCUL shall provide the following documents:
  - a. The Network Diagram, covering the relevant assets
  - b. Latest relay settings adopted and calculations for respective sub-stations and transmission lines.
  - c. Annual maintenance plan (AMP), including the schedule and activities covered under AMP
  - d. Any specific issues covered under OCC and/or PSC of NRPC for relevant assets.
- For each sub-station, check-list shall be provided by PTCUL. During field visit, the information shall be verified.
- The minimum set of points on which checking and validation shall be carried out is provided as per annexure - 4 for the following available power system elements at station, as per attached formats:

Sl. No.	Elements
1	Transmission Line
2	Bus Reactor/Line Reactor
3	Inter-connecting Transformer
4	Busbar
5	AC auxiliary system
6	DC auxiliary system
7	Communication system
8	Circuit Breaker Details
9	Current Transformer Details
10	Capacitive Voltage Transformers Details
11	Any other equipment/system relevant for protection system operation

- During field visit, no testing of equipment and relay shall be carried out. The visual inspection, operational log shall be considered for audit purpose, apart from the documents provided by PTCUL
- A calibrated multi-meter shall be provided at sub-station for checking AC and DC voltages and currents online, wherever feasible, without impacting the sub-station operations.

- The preliminary report shall be prepared on the site and shall be signed by all the parties present, as given below:

S. No.	Issues	Remarks
1	Recommendation of last protection checking and validation	Status of works and pending issues if any
2	Review of existing settings at substation	Recommended Action
3	Disturbance Recorder out/ available for last 6 tripping's (Y/N)	Recommended Action
4	Chronic reason of tripping, if any	Recommended Action
5	Major non-conformity/deficiency observed	Recommended Action

- **The Final summary shall specifically mention minimum following points:**
  - The settings and scheme adopted are in line with agreed protection philosophy or any accepted guidelines (e.g., Ramakrishna guidelines or CBIP manual based).
  - The deviations from the RPC protection philosophy, if any and reasons for taking the deviations shall be recorded.
  - All the major general deficiency shall be listed in detail along with remedial recommendations.
  - The cases of protection maloperation (last 1 year) shall be analysed from tripping reports and the causes of failure along with corrective actions and recommendations based on the findings.

## ***2.5. About Power Transmission Corporation of Uttarakhand (PTCUL)***

The State of Uttarakhand's power transmission utility, PTCUL, was formerly known as Uttaranchal. According to the Uttar Pradesh State Reorganization Act 2000, this 27<sup>th</sup> state of the republic of India was formed on November 9, 2000, by dividing the Himalayan and surrounding North-Western districts of Uttar Pradesh.

The State of Uttaranchal in exercise of the power granted to it under section 63(4) of the State Re-Organization Act, 2000, formed two separate companies in power sector:

- Uttaranchal Jal Vidyut Nigam Ltd. (UJVNL) – For generation of Hydro-Electricity in the State.
- Uttaranchal Power Corporation Ltd. (UPCL) – For Transmission and Distribution of Electricity in the state.

Enactment of the Electricity Act 2003, a distinct watershed in the Indian Power Sector, made it mandatory for all the States to restructure their SEBs. As per the provisions of Electricity Act 2003, the State Government separated power transmission business from UPCL which was left only with distribution of electricity.

In order to manage Power Transmission Operations, a new company called Power Transmission Corporation of Uttaranchal Ltd. was established. On 27<sup>th</sup> May, 2004, the firm was formed as a Government Company in accordance with section 617 of the Companies Act, 1956. It began operating from 1<sup>st</sup> June, 2004.

The company's corporate and registered office is located in Vidyut Bhawan, Saharanpur Road, Majra, Dehradun, next to the ISBT Crossing.

## ***2.6. About Central Board of Irrigation & Power (CBIP)***

The Government of India established the Central Board of Irrigation and Power in 1927, making it a Premier Institution. For the past 93 years, CBIP has provided committed services to the nation's professional associations, engineers, and individuals involved in the power, water resources, and renewable energy sectors. While serving the country equally and to great honour, CBIP has developed into an esteemed institution of international significance. CBIP is Indian chapter for 10 international organizations related to Power & Water resources sectors.

CBIP is involved in executing various activities such as, International Conferences, Technical Documents Publications, Training Activities, Research & Development, Consultancy Services including Technical, Protection & Safety Audits.

### 3.0. Preliminary Audit of 220/132KV Roorkee Substation

#### 3.1. General Information about Substation

Sl. No.	Particulars	Details
1	Substation Name	220/132/33 kV Roorkee
2	Name of Owner Utility	Power Transmission Corporation of Uttarakhand Limited (PTCUL)
3	Voltage Level (s) or highest voltage level	220/132/33 kV
4	Short circuit current rating of all equipment (for all voltage level)	40KA & 50KA
5	Date of commissioning of the substation	10 <sup>th</sup> February 2005
6	Checking and validation date	23 <sup>rd</sup> – 24 <sup>th</sup> February 2024

#### 3.2. Audit Team

**Audit Team (CBIP):**

- Mr. Vijay Barthwal
- Mr. M.R. Chauhan
- Mr. Shivam Gupta
- Mr. Avichal Pandey

**PTCUL Representative:**

- Er. Ashwini Kumar, Executive Engineer (T&C)
- Er. Vipin Kumar, Executive Engineer (O&M)
- Er. Virendra Singh Mehra, Assistant Engineer (T&C)
- Er. Amrish Kumar, Assistant Engineer (O&M)

### 3.3. Recommendation of last protection checking and validation

Last protection audit was carried out by NRPC on 11 Oct 2022 by NRPC along with Power Grid Corporation.

Protection/Element/ Equipment/ System audited	Deficiencies/Nonconformity observed	Status
Distance protection for following feeders: i) Main-1 Nara line ii) Main-1 Puhana line iii) Main-1 Railway lines	Only one distance protection relay (Main-1) is available on both 220kV feeders. It is recommended to install main-2 relay for the backup of main-1 distance protection.	To be analysed & implemented, based on new guidelines from NRPC
Directional Earth Fault(67N) for following feeders: i) Main-1 Nara line ii) Main-1 Puhana line iii) Main-1 Railway lines	DEF (67N) function although available in main-1 relays yet it is disabled. As per Model Relay Setting Guidelines, it is recommended to enable 67N in both Main-1 & Main-2 relays. However, separate Over current and earth fault relay is provided in place of Main-2	
Power swing function for following feeders: i) Main-1 Nara line ii) Main-1 Puhana line iii) Main-1 Railway lines	i) Power swing is kept enabled except zone-3 in Puhana line. ii) Power swing is disabled in railway line and Nara line. As per protection Philosophy of Northern region, the block tripping in all zones, all lines. out of step tripping to be applied on all inter regional tie lines (Deblock time delay=2s) but if Out -of step function is not activated then Power swing shall be blocked for Zone-2 and above and Zone-1 shall be unblocked.	

Protection/Element/ Equipment/ System audited	Deficiencies/Nonconformity observed	Status
<p>Overvoltage protection for following feeders:</p> <ul style="list-style-type: none"> <li>i) Main-1 Nara line</li> <li>ii) Main-1 Puhana line</li> <li>iii) Railway Line</li> </ul>	<p>Overvoltage function is disable in all lines. As per guideline relay settings two stage overvoltage protection shall be provided. Low set stage (Stage-I) may be set in the range of 110% - 112% (typically 110%) with a time delay of 5 seconds. High set stage (Stage-II) may be set in the range 140% - 150% with a time delay of 100milliseconds.</p>	
<p>Auto-reclose function for following feeders:</p> <ul style="list-style-type: none"> <li>i) Main-1 Nara line</li> <li>ii) Main-1 Puhana line</li> <li>iii) Railway Line</li> </ul>	<p>Auto-Reclose enabled in 220kV Nara and Puhana Line except Railway Line.</p> <p>1) Dead Time and Reclaim Time Setting of Auto Reclosure relays (Dead time = 1sec, Reclaim Time =25 sec) are not found as per Model Relay Setting / CBIP Guidelines (i.e. Dead Time = 1 sec, Reclaim Time = 25 sec).</p> <p>It is recommended to adopt AR settings as per the recommendation.</p>	
<p>Broken Conductor function for following feeders:</p> <ul style="list-style-type: none"> <li>i) Mi) Main-1 Nara line</li> <li>ii) Main-1 Puhana line</li> <li>iii) Railway Line</li> </ul>	<p>Broken conductor function is not enabled in Railway Line and Nara Line. It is advised to keep broken conductor function active as per model relay setting guidelines.</p>	
<p>Breaker failure function for following feeders:</p> <ul style="list-style-type: none"> <li>i) Main-1 Nara line</li> <li>ii) Main-1 Puhana</li> </ul>	<p>It is observed that only single stage CBF protection is used for tripping of boundary breakers. As per model relay setting guidelines it is recommended to provide two stage CBF protection first for re-tripping own CB and second for boundary CBs.</p>	

Protection/Element/ Equipment/ System audited	Deficiencies/Nonconformity observed	Status
line iii) Railway Line		
Distance protection Zone-1 settings for following feeders: i) Railway Line	The time settings is 100% of the line length. As per model relay settings it shall be 80% of line length. It is advised to review the settings for zone-1.	
Distance protection Zone-2 settings for following feeders:i) Puhana Line	Zone-2 time setting for Puhana line is 400ms.As per model relay settings it shall be 350ms for short line (<100km)	
Distance protection reverse zone settings for following feeders: i) Main-1 Puhana line ii) Railway Line	It is found that zone reach setting for Puhana line is 36% of zone 1 reach and time setting is 2s of reverse zone of M1 distance relay.  For Railway line reverse zone reach setting found 12.73% of zone 1 reach.  As per NRPC protection philosophy setting the Reverse zone shall be 25% of the zone-1 reach with time setting of 1s. The same may be checked.	
Busbar protection Main-1, Main-2 and Transfer bus	Busbar protection is out of service due to mismatching of CTs ratio. It is recommended for 220kV busbar protection to be replaced with numerical relays.	
WTI for MV and LV winding Cooling Fan Fire Protection System FOTC	i) ICT-1 WTI (HV), ICT-2 WTI (IV) and WTI (LV) temperature indicator not operational in the RTCC panel. It is recommended to replace faulty Winding temperature indicators so as to ensure proper monitoring of transformers from the control room itself.  ii) Cooling fan of ICT-1 not in service.  iii) NIFPS for ICT-1 and 2 kept in manual mode.	No Change



<b>Protection/Element/ Equipment/ System audited</b>	<b>Deficiencies/Nonconformity observed</b>	<b>Status</b>
	Fire protection system should be kept in auto mode for the protection of transformer in case of fire.	
Surge counter FOTC WTI/OTI Fire Protection System	i) leakage current being recorded as “0 mA” for all phases of 50MVA-1 is defective. Same needs to be replaced with new one. ii) FOTC for Transformer-1 & 2 not working. iii) OTI temperature indicator for transformer-1 & 2 in RTCC panel not in operation. iv) Fire protection system for transformer-1 is out of service. Recommended to rectify the fire protection system and put in service.	
DC charger for 110V and 50V	Both 110V DC battery bank have +ve earthed, Need to rectify. Both 50V Battery bank and Chargers not in service.	
DC source	Earth Fault observed in both the DC sources at charger end. DC voltage from negative to earth at source-1 & 2 is observed to be inadvertently high for 110V DC system.	
Earth leakage relay for 220V and 50V system	Not available.	
Source of AC supply	Two individual sources of LVAC supply is available for the auxiliary load consumption in the substation.	
DG and AMF panel	DG in Auto mode	
SF6 gas quality CRM, DCRM and	No record of Circuit Breaker testing available.	

<b>Protection/Element/ Equipment/ System audited</b>	<b>Deficiencies/Nonconformity observed</b>	<b>Status</b>
Time check Testing of CB		
CVTs	No record of CVT testing available.	
SAS & DR	DR PC available but not in service due to some connectivity issue. Some signals are not properly displays on SLD of SAS PC.	
PLCC	PLCC not used for tele protection.	
Synchro-Check	Synchronisation trolley available but not in service.	
Panel Meters	most of the panel meter (Ammeter, Voltmeter, wattmeter etc.) are not working. Recommend to replace the defective meters for proper monitoring.	In process

### ***3.4. Review of existing settings at substation***

- a. Utility has provided relay settings adopted for various feeders and transformers.
- b. The record of different relay setting calculations is not available at the substation level.
- c. All relays are numeric, as per internal protocol of utility relays are tested on yearly basis and at the time of commissioning/change in setting. Copy of test reports not available at substation level.
- d. Based on the protection audit held on 11<sup>th</sup> October 2022, the utility is in the process of updating the recommendation related to the relay settings.

### ***3.5. Disturbance Recorder availability for the last 6 tripping's***

- a. Utility is submitting Disturbance Recorder data for both Inter-State Lines(Pohana and Nara) to NRLDC Portal. The record is not maintained at substation level.
- b. For transformers and other lines DR data is taken at station level for analysis purpose, no centralized record of such data is kept at substation level.

### ***3.6. Chronic reason of tripping, if any***

- a. Based on list of tripping submitted by utility for last 12 months, 220kV Roorkee Nara line tripped 11 times due to transient earth fault. In almost all cases the fault current is not very high indicating high resistance fault.
- b. On 29/08/2023 at 10:44 due to 132kV bus fault multiple tripping took place.
- c. 50 MVA 220/33 kV Trf-2 tripped on 06/07/2023 and 15/07/2023 due to transient fault on 33 kV line at high current on transformer.
- d. Some tripping are recorded due to switch yard water logging.

### ***3.7. Major non-conformity/deficiency observed***

- a. The status of major non confirmatory as pointed out in the previous audit report and its compliance is provided in previous paragraphs.
- b. Bus Bar Protection on 220kV Bus is not functional after addition of the new elements with the 220kV bus.
- c. No provision for Bus Bar Protection is available at 132kV level.
- d. PLCC is unhealthy and therefore tele protection is out of service.
- e. SAS has been commissioned. It is observed that SAS is not in regular use and therefore, some of the inputs are not available. The effectiveness of SAS can be improved by using SAS regularly.
- f. Both the 110V DC systems are showing earth-fault.
- g. Both the 220kV circuits are operating without carrier protection, however the auto reclosure is enabled.
- h. 3 nos. GPS Time Synchronization Systems are provided in the substation. One system caters to SAS and other two caters to relays and other equipment's of the respective substation i.e. old 132 kV. Only one GPS associated with 220kV site is functional, but the relays are connected to SAS GPS, therefore presently no relay is time synchronised.
- i. The events are recorded from individual relays, no separate Event Logger is provided. The SAS has the event logging capability but is not in regular use.
- j. Recommended relay settings with supporting calculations/ parameters needs to be kept at sub-station.
- k. All the isolators are operated manually. The AC and DC system needs to be checked during maintenance to avoid earth faults in auxiliary system.
- l. The record of equipment testing is not maintained at substation level.

- m. Necessary action for avoiding water logging and consequential maloperation of protective system needs to be taken.
- n. Currently the successful auto reclosures are being recorded in the log book however no separate analysis record is being maintained.

## 4.0. List of Trippings

Name of Feeder/TF	Type of	Date Time of Tripping	Date & Time of closing	flags observed	Other end flage	affected generation/load	Tripping Analysis / Action taken report	Category Code	Action Taken
40MV A 1	Siemens	01.47 hrs 30.01.2023	02.02 hrs 30.01.2023	CP-HV O/C & E/F optd, 186 H/L trip relay optd, Led 1,2,3,5	NA	NIL	Tripped with 33 kv Himalayan Guest House	LEF T	Inform ed to O&M wing for requir ed action
20MV A 2		01.47 hrs 30.01.2023	02.02 hrs 30.01.2023	RP- 186H/L optd	NA	NIL			
40MV A 3		01.47 hrs 30.01.2023	02.02 hrs 30.01.2023	CP-HV O/C & E/F optd, 186 H/L trip relay optd, Led 1,2,3,5	NA	NIL			
132kV Roorkee-Sidcul line CB-72	Siemens	17:46 hrs 14/01/2023	20:18 hrs 14/01/2023	NA	CP-back relay dir o/c optdoptd, , RP- mtr-86-1, 86-2 optd, dir oc e/f, 67/67N trip, 50/51trip, led grp 2, dist-0.5km L1-13908A, L2-207.8A,L3-367.4A,	NA	trip due to overload	CMS T	Inform ed to O&M wing for requir ed action
220kV Roorkee-Puhana line CB-	Alstom, Micom	17:46 hrs 14/01/2023	20:04 hrs 14/01/2023	CP- Dir trip R phase OPTD, RP- 27 R,Y,B phase, dist carrier recieved,dist trip ABC, Trip relay 86, 86X, Z1 OPTD, Distance-1.325 km L1-2.616kA, L2-5900A,L3-1.078kA,	NA	All accocia ted lines	Transient earth fault	TLF	Inform ed to O&M wing for requir ed action
40MVA 1 132/33kV	Siemens	03:10 hrs 20/01/2023	03:30 hrs 20/01/2023	CP- HV OC & EF optd, 186H & 186L trip relay, RP- LBB protn relay 50Z LED -1,2 L1-0.66kA, L2-0.03kA, L3-0.03kA, MTR-186	NA	nil	Both T/F trip with 33kv Himalayan guest house feeder	TLF	Inform ed to O&M wing for requir ed action
20MV A 2	Siemen	03:10 hrs 20/01/2023	03:30 hrs 20/01/2023	MTR 186H & 186L trip					

Name of Feeder/TF	Type of	Date Time of Tripping	Date & Time of closing	flags observed	Other end flage	affected generation/ load	Tripping Analysis / Action taken report	Category Code	Action Taken
132kV Roorkee-Jwalapur line CB-71	Siemens	18.48 hrs 09.03.2023	19.10 hrs 09.03.2023	MTR optd, Dist protn optd, Led no.5, MTR 86, L1-190.5A, L2-3.039kA, L3-141.30 A	CP- Back up relay, dir o/c optd, E/F optd, RP-Tirp 50/51 p trip, 50/51 G trip, main 3 phase trip relay (86-1 86-2), cb gas low trip lockout GA, GL spare relay	nil	Transient earth fault	LEF T	Informed to O&M wing for required action
20M VA	Siem	4.48 hrs 19.04.2023	5.22 hrs 19.04.2023	Led 1,5,6 MTR 86H 86L Ia-2.438kA,	NA	nil	Both trnasformer Tripped with 66kV C/B-63	TLF	Informed to O&M wing for required action
20MVA 2 132/66kV	GE	4.48 hrs 19.04.2023	5.22 hrs 19.04.2023	O/c E/f protn optd Led-1,5 Ia-1.633kA	NA				
132kV Roorkee-	Siemens	01.05.2023 12.10 hrs	01.05.2023 21.41 hrs	CP- MTR optd, Dist prot optd, Dist prot strt, RP- Dist protn relay, Led-1,3,5,9 Dist pickup L2-E, Dist loop L2-E, L1-0.21kA,L2-10.15kA,L3-0.13kA	Dist protn strt, MTR optd, Dist prot strt,MTR optd,	nil	Transient Earth Fault	TLF	Informed to O&M for required action
CB NO.77 (L.S.M)	Siemens	11-05-2023/04 :48	11-05-2023/05 :01	CP:-DISTANCE PROTECTION RELAY OPERATED MASTER TRIP RELAY OPERATED . RP:- DISTANCE PROTECTION RELAY DISTANCE PICKUP L1E, DISTANCE 2.2KM, D%=29.4% IL1=6.22KA,IL2=0.06KA,IL3=0.02KA, MTR-186.	NA	Nil	Transient Earth Fault	TLF	Informed to O&M wing for required action
132V JWALAPUR CB NO.71	SIEMENS	18-05-2023/02 :11	18-05-2023/03 :04	CP-DIST OPTD, DIST PROTN START,MTR PRD RP-DIST PROTN REAL LED 1,4,5 ,IA=148.3A ,IB=25.60A IC=23.91A, DIST=38.68KM MTR-186	CP- PICKUP P RELAY DIST. O/C OPERATE D, EARTH FAULT OPERATE D RP- 50/51 TRIP, Ia=5.48, Ib=0 Ic=0 MTR(86-1) MTR (86-2)	nil	Due to bad weather	TLF	Informed to O&M wing for required action

Name of Feeder/TF	Type of	Date Time of Tripping	Date & Time of closing	flags observed	Other end flage	affected generation/load	Tripping Analysis / Action taken report	Category Code	Action Taken
20 MVA T/F 1 CB NO. 783/683	SIEMENS	18-05-2023/02:07	18-05-2023/8:26	CP-DIST PROTN RELAY LED 1,3 RP-TRIP PHASE AN,START I>134 O/C I>4 E/F-1, START IN1>134, E/F-2, TRIP IN1>34, IA=2.274KA IB=75.82A IC=265.6A IN MEASURED =2.609KA IN DERIVED=2.606KA	NA	nil	Transient Earth Fault	TLF	Inform ed to O&M wing for requir ed action
132kV Chudiyala-Roorkee line CB-78	GE	19/05/2023 10:56 hrs	19/05/2023 11:41 hrs	CP-MTR OPTD, DIST PROTN START, DIST PROTN OPTD. RP-DIST PROTN RELAY 21 LED 1,2,5,9 FAULT EVENT ON, DIST PICKUP LIE ON, DIST LOOP LIEF ON, DIST TRIP 1PL1 ON, DIST TRIP Z1/1P ON, DEFINITIVE TRIP ON DIST T SEND ON, AR TRIP 3 POLE ON, IL1-9.07KA, IL2-0.29KA, IL3-0.23KA DIST TRIP 3P, DISTANCE=0.7KM D%=4.6%	NA	nil	Transient Earth Fault	TLF	Inform to O&M wing for requir ed
CB NO. 81 NARA LINE	Micom	13.10 hrs 08.06.2023	NA	CP-A/R LOCKOUT BREAKER AUTO TRIP RP- Z1 27RYB 86ABC 21X TRIP RELAY 86 FAULT DURATION 40 ms CB OPERATE TIME 35 ms RELAY TIME 0 ms IA=175A IB=353.3A IC=199A VA=137.2KV VB=137.9KV VC=8.858KV	NA	Nil	<b>Transient Earth Fault</b>	TLF	Inform ed to O&M wing for requir ed action
CB NO. -81 (NARA)	Micom P545	10-06-2023 07:45H RS	10-06-2023 10:37H RS	CP- POLE DEAD, CB AUTO TRIP, RP- 86A, 27 RYB, CB AUTO TRIP Z1, FAULT DURATION-36MS, FAULT LOCATION=4.670KM, IA=248.4A, IB=160.4A, IC=353.2A	NA	Nil	Transient Earth Fault	TLF	Inform ed to O&M for requir ed action
CB NO.67 SAHARANPUR	SIEMENS	18.06.23 05:49	18.06.23 19:02	TRIPPED ON O/C E/F, MTR DISTANCE PROTN START LED 4 IA=33.7A IB=2.676A IC=2.920A	NA		TRANSIENT LINE FAULT	TLF	Inform ed to O&M wing fpr requir ed action
CB NO.67 (SAHARANPUR)	SIEMENS	19.06.23 03:01	19.06.23 03:10	DISTANCE RELAY=LED 1,2,5,6 IL1=1.01KA IL2=0.04KA IL3=0.04KA DIST=40.7KM O/C E/F RELAY=LED 1,5,6 IL1=1.029KA IL2=44.4A IL3=3.23A	NA	Nil	TRANSIENT LINE FAULT	TLF	Inform ed to O&M wing fpr requir ed action

Name of Feeder/TF	Type of	Date Time of Tripping	Date & Time of closing	flags observed	Other end flage	affected generation/load	Tripping Analysis / Action taken report	Category Code	Action Taken
CB NO.781/381 40MVA T/F 1	SIEMENS	19.06.23 12:45	19.06.23 13:11	CP-186H TRIP RELAY OPTD 186 L TRIP OPTD RP- O/C E/F (LV) TRIPPED PHASE N, TRIP IN1>3 IA=3.419 KA IB=561.8A IC=342.1A IN=3.548KA (HV)=RELAY TRIP ON DIR O/C TRIP ON IE>DIR TRIP ON IL1=0.86KA IL2=0.14KA IL3=0.13KA	NA	Nil	DUE TO PROBLEM IN CAPACITOR BANK BAY	LH WT	Inform ed to O&M wing fpr requir ed action
CB NO.786/386 40MVA T/F 3	SIEMENS	19.06.23 12:45	19.06.23 13:11	CP-HV O/C E/F LV O/C E/F RP-(HV) RELAY TRIP ON DIR O/C TRIP ON IE>DIR TRIP ON IL1=0.93KA IL2=0.14KA IL3=0.15KA (LV)- TRIPPED PHASE N TRIP IN1>3 IA=3.743 KA IB=551.2A IC=363.1A	NA	Nil	DUE TO PROBLEM IN CAPACITOR BANK BAY	LH WT	Inform ed to O&M wing fpr requir ed action
CB NO.782/382 20MVA T/F 2	SIEMENS	19.06.23 12:45	19.06.23 13:11	CP-LED 6 MTR 86 RP-(HV) RELAY TRIP ON DIR O/C TRIP ON IE> DIR TRIP ON IL1=0.6KA IL2=0.07KA IL3=0.08KA (LV)- TRIPPED PHASE N E/F TRIP IN 1>3 IA=1.834KA IB=277.6A IC=168.2A IN=1.912KA	NA	Nil	DUE TO PROBLEM IN CAPACITOR BANK BAY	LH WT	Inform ed to O&M wing fpr requir ed action
CB NO. 72 ROORKEE-SIDCUL	SIEMENS	22.06.2023 05:52	22:06:23 06:16	TRIPPED ON MTR OPTD DIST PROT N START DIST PROTN OPTD LED=1,4,5,9 MTR-86 IA=0.14KA IB=0.20KA IC=3.32KA DIST=16.2KM	CP- BACKUP RELAY DIR E/F OPTD BACKUP REALY DIR. O/C OPTD RP-50/51 TRIP 50/51G TRIP DIST=0.5 KM IA=.13A IB=0.18A IC=5.38K A	NIL	TRANIENT LINE FAULT	TFL	Inform ed to O&M wing fpr requir ed action



Name of Feeder/TF	Type of	Date Time of Tripping	Date & Time of closing	flags observed	Other end flage	affected generation/ load	Tripping Analysis / Action taken report	Category Code	Action Taken
CB NO.73 ( RKE-LAKSAR )	SIEMENS	25.06.23 08:34	25:06:23 08:57	CP-MTR OPTD DIST PROTN START RP-LED 1,3,7 DIST LOOP L2-E IL1=0.13KA IL2=3.63KA IL3=0.11KA FL LOOP L2-E MTR 186	CP-DIST PROTN OPTD DIST PROTN START A/R BLOCKE D MTR OPTD RP-86 86 L2-E IL1=0.41K A IL2=1.89K A IL3=0.25K A DIST=6.6 KM	NIL	DUE TO BAD WEATHER	TLF	Informed to O&M wing for required action
CB NO.71 JWALAPUR	SIEMENS	26.06.23 23:07	26:06:23 23:30	CP-MTR OPTD DIST PROTN OPTD RP-DIST PROTN RELAY LED-3,4,5 Z3 MTR 186 50Z/LBB PROTN RELAY LED-1,2 DIST=63.7KM IA=64.55A IB=84.70A IC=1.606KA	BACKUP RELAY DIR OC OPTD IA=0.05 IB=0.07 IC=5.8 VAB=130. 84 VBC=108 VCA=102. 04	NIL	TRANSIENT LINE FAULT	TLF	Informed to O&M wing for required action
CB NO.72 SIDCUL	SIEMENS	28.06.23 03:53	28:06:23 04:34	MTR OPTD DIST PROTN START DIST PROTN OPTD LED-1,4,5,9 DIST=19.9KM ILA=0.18KA IB=0.14KA IC=2.84KA MTR86	BACKUP RELAY DIR O/C OPTD BACKUP RELAY EARTH FAULT OPTD RP-TRIP 50/51 TRIP MAIN3 PHASE TRIP RELAY-1 (88-1) MAIN 3 PHASE TRIP RELAY- 2(86-2) DIST=0.5 KM	NIL	Transient Line Fault	TLF	Informed to O&M wing for required action

Name of Feeder/TF	Type of	Date Time of Tripping	Date & Time of closing	flags observed	Other end flage	affected generation/load	Tripping Analysis / Action taken report	Category Code	Action Taken
CB NO.72 SIDCUL	SIEMENS	28.06.23 06:08	28.06.23 13:57	MTR OPTD DIST PROTN START DIST PROTN OPTD LED-1,4,5,9 DIST=19.9KM ILA=0.14KA IB=0.01KA IC=2.88KA MTR86 DIST=19.9KM	CP- BACKUP RELAY DIR O/C OPTD BACKUP RELAY DIR EARTH FAULT OPTD CARRIER FAILED RP-50/51 TRIP 50/51 G TRIP MAIN 3 PHASE TRIP RELAY- 1(88-1) MAIN 3 PHASE TRIP RELAY-2 (86-2) DIST=0.5 KM	NIL	Transient Line Fault	TLF	Inform ed to O&M wing fpr requir ed action
CB NO. 67 SAHARANPUR	SIEMENS	01.07.23 08:01	01.07.23 08:20	CP-DIST PROTN RELAY RELAY LED-1,2,5,6 DIST PICKUP L1E DIST=41.2KM IL1=1.17KA IL2=0.04 KA IL3=0.03KA O/C E/F RELAYED=1,5,6 MTR	NA	NIL	TRANSIENT LINE FAULT	TLF	Inform ed to O&M wing fpr requir ed action

Name of Feeder/TF	Type of	Date Time of Tripping	Date & Time of closing	flags observed	Other end flage	affected generation/ load	Tripping Analysis / Action taken report	Category Code	Action Taken
CB NO.78 CHUDIYALA	GE	05.07.23 6:00	05.07.23 6:14	CP-MTR OPTD DIST PROTN OPT DIST PROTN START RP-DIST PROTN RELAY LED-1,4,5,9 DIST PICKUP L3E DIST LOOP L3-E DIST=2.7KM DIST TRIP Z1/1P IL1=0.22KA IL2=0.15KA IL3=5.84KA MTR 186	MAIN RELAY DIST PROTN OPTD RP- MAIN PROTN (86-1) FOR BACKUP PROTN (86-2) DIST=9.2 KM IL1=0A IL2=0A IL3=3322. 1A LED GROUP 1 GND DIST Z1 OPTD, LED GRP- 2 A/R BLOCKE D TRIP OTHR PHASE-C	NIL	TRANSIENT LINE FAULT	TLF	Inform ed to O&M wing fpr requir ed action
50MVA T/F 1	ABB	06.07.23 04:07	06.07.23 7:35	CP-MTR GROUP A,B OPTD TERFO TROUBLE ALARM MTR GRP A,B RP-TERFO DIFFERANCIAL PROTN LED-1,2 AUX RELAY BUCHHOLZ ALARM WTI ALARM OTI ALARM OTI TRIP 86B SPRING CHARGE 8A ACTIVE GRP 1 FAULT DURATION=35ms CB OPT TIME=30ms	NA	NIL	DUE TO WATER IN MARSHALI NG BOX	SEM T	Inform ed to O&M wing fpr requir ed action
CB NO.67 SAHARANPUR	SIEMENS	06.07.23 11:33	06.07.23 11:41	O/C E/F LED 1,5,6 21 FDR DIST=8.5KM IL1=0.04KA IL2=1.88KA IL3=0.04KA 67,50 BF RELAY IL1=46.95A IL2=2.146KA IL3=46.02A MTR 186	NA	NIL	TRANSIENT LINE FAULT	TLF	Inform ed to O&M wing fpr requir ed action
50 MVA T/F 2	ABB	06.07.23 15:05	06.07.23 15:36	HV TRIP CP-MTR GRP-A,B RP-86A 86B	NA	NIL	TRANSIENT Earth FAULT	TLF	Inform ed to O&M wing fpr requir ed action

Name of Feeder/TF	Type of	Date Time of Tripping	Date & Time of closing	flags observed	Other end flage	affected generation/load	Tripping Analysis / Action taken report	Category Code	Action Taken
CB NO 71 JWALAPUR	SIEMENS	08.07.23 09:31	08.07.23 09:54	MTR OPTD LED-1,2,3,4 MTR86 IA=1.199KA IB=1.314KA IC=167.7 A	NA	NIL	TRANSIENT LINE FAULT	TLF	Inform ed to O&M wing fpr requir ed action
50MVA T/F 2	ABB	10.07.23 15:31	10.07.23 15:38	CP-MTR GRP A&B OPTD RP-86A 86B	NA	NIL	TRANSIENT LINE FAULT	TLF	Inform ed to O&M wing fpr requir ed action
CB NO.67 SAHARANPUR	SIEMENS	10.07.23 11:46	10.07.23 11:55	O/C & E/F DIST=29.4KM IA=1.469KA IB=50.42A IC=29.39A DIST PICKUP L1E ON DIST 3P ON IL1=1.45KA IL2=0.05KA IL3=0.04KA	NA	NIL	TRANSIENT LINE FAULT	TLF	Inform ed to O&M wing fpr requir ed action
CB NO.67 SAHARANPUR	SIEMENS	11.07.23 05:50	11.07.23 05:57	DIST PICKUP L1E ON DIST TRIP3P ON IL1=1.88KA IL2=0.02KA IL3=0.01KA DIST=17.21KM IA=2.137KA IB=19.53A IC=12.87A	NA	NIL	TRANSIENT LINE FAULT	TLF	Inform ed to O&M wing fpr requir ed action
CB NO.67 SAHARANPUR	SIEMENS	11.07.23 06:58	11.07.23 07:35	OC & E/F DIST=17.1KM IA=2.48KA IB=21.86A IC=12.62A MTR 186 IL1=2.08KA IL2=0.0KA IL3=0.01KA	NA	NIL	TRANSIENT LINE FAULT	TLF	Inform ed to O&M wing fpr requir ed action

Name of Feeder/TF	Type of	Date Time of Tripping	Date & Time of closing	flags observed	Other end flage	affected generation/ load	Tripping Analysis / Action taken report	Category Code	Action Taken
CB NO.72 SIDCUL	SIEMENS	11.07.23 21:07	11.07.23 21:29	CP-MTR DIST PROTN START DIST PROTN OPTD LED=1,4,9 DIST=11.7KM MTR 86 IL1=0.18KA IL2=0.15KA IL3=0.38KA	CP- BACKUP RELAY DIR O/C OPTD BACKUP RELAY DIR E/F OPTD CARRIER FAILED RP-MAIN 3PHASE TRIP RELAY-1 86-1 MAIN 3 PHASE TRIP RELAY-2 86-2 TRIP 50/51P TRIP DIST=0.5 KM IA=13908. 7A IB=207.8A IC=367.4A	NIL	TRANSIENT LINE FAULT	TLF	Informed to O&M wing fpr required action
CB NO 73 LAKSAR LINE	SIEMENS	12-07-23 18:08	12-07-23 19:41	CP-MTR OPTD DIST PROT OPTD DIST PROT START RP-DIST PROT RELAY LED-1,4,7 DIST PICKUP L3E IL1=0.11KA IL2=0.14KA IL3=3.46KA DIST=103.3KM	NT	NIL			Informed to O&M wing fpr required action
CB NO 63 THITHKI 1	SIEMENS	12-07-23 11:15	12-07-23 12:10	CP-MTR OPTD MTR UNHEALTHY RP-DIST PROT LED-1,2,3 DIST PICKUPL1E DIST TRIP Z1/1P IL1=0.88KA DIST=15.8 KM	NT	NIL	TRANSIENT LINE FAULT	TLF	Informed to O&M wing fpr required action
CB NO 67 SAHARANPUR	SIEMENS	12-07-23 15:05	12-07-23 15:28	DIST PROT RELAY LED- 1,3,5,6 DIST PICKUP L2E DIST TRIP 3P Z1SF IL1=0.02KA IL2=1.44KA IL3=0.04KA DIST=23KM OC/EF LED-2,5,6	NA	NIL	TRANSIENT LINE FAULT	TLF	Informed to O&M wing fpr required action
CB NO 64 THITHKI 2	SIEMENS	13-07-23 5:35	13-07-23 6:28	CP-DIST PROTN OPTD MTR OPTD ,SOTF OPTD DIST PROTN DIST PROT START RP-LED-1,3,5,6,11 DIST PICKUP L2E DIST TRIP 3P Z1SF DIST=3.2KM MTR 8 IL1=0.17KA IL2=1.22KA IL3=0.16KA	NA	NIL	TRANSIENT LINE FAULT	TLF	Informed to O&M wing fpr required action

Name of Feeder/TF	Type of	Date Time of Tripping	Date & Time of closing	flags observed	Other end flage	affected generation/load	Tripping Analysis / Action taken report	Category Code	Action Taken
40MVA T/F 1ST	MICOM	13-07-23 05:41	13-07-23 18:40	CP-186H TRIP RELAY OPTD 186L TRIP RELAY OPTD OSR/PRV TRIP RP-TRAFO TROUBLE MULTI RELAY OSR TRIP 186H/186L	NA	NIL	TRIPPED WITH 12.5 MVA T/F	CMS T	Informed to O&M wing fpr required action
CB NO 67 SAHARANPUR	SIEMENS	15-07-23 08:40	15-07-23 09:07	DIST PICKUP L1E ON DIST TRIP3P ON IL1=2.95KA IL2=0.04KA IL3=0.03KA DIST=3.9KM	NA	NIL	TRANSIENT LINE FAULT	TLF	Informed to O&M wing fpr required action
40MVA T/F 1ST	MICOM	15-07-23 06:32	15-07-23 07:15	CP-HV AND LV O/C RELAY OPTD ,186H,L OPTD RP-LED-1,2,3,5 IL1=1.17KA IL2=1.13KA IL3=0.15KA	NA	NIL	TRIPPED WITH 12.5 MVA T/F	CMS T	Informed to O&M wing fpr required action
20MVA T/F 2ND	MICOM	15-07-23 06:32	15-07-23 07:15	RP-LED-1,2,3,5 IL1=0.05KA IL2=0.52KA IL3=0.04KA	NA	NIL	TRIPPED WITH 12.5 MVA T/F	CMS T	Informed to O&M wing fpr required action
40MVA T/F 3RD	MICOM	15-07-23 06:32	15-07-23 07:15	CP-HV AND LV O/C RELAY OPTD ,186H,L OPTD RP-IL1=0.11KA IL2=1.04KA IL3=0.06KA	NA	NIL	TRIPPED WITH 12.5 MVA T/F	CMS T	Informed to O&M wing fpr required action
CB NO. 77 LSM	SIEMENS	15-07-23 11:57	15-07-23 12:11	CP-MTR OPTD DIST PROTN OPTD DIST PROTN START RP-LED-1,2,5,9 MTR 86 DIST TRIP3P IL1=5.89KA IL2=0.04KA IL3=0.03KA DIST=2.3KM	NA	NIL	TRANSIENT LINE FAULT	TLF	Informed to O&M wing fpr required action

Name of Feeder/TF	Type of	Date Time of Tripping	Date & Time of closing	flags observed	Other end flage	affected generation/ load	Tripping Analysis / Action taken report	Category Code	Action Taken
CB NO.73 LAKSAR LINE	SIEMENS	19-07-23 14:47	19-07-23 15:05	CP-DIST PROTN OPTD DIST PROTN START MTR OPTD RP=DIST TRIP 3 POLE DIST TRIP Z3/T3 IL1=0.14KA IL2=3.29KA IL3=0.10KA DIST=12.1KM FL LOOP L2E	CP-DIST PROTN OPTD MTR OPTD MTR OPTD DIST PROTN START AR BLOCK RP-G-T Y PHASE PICKUP Z1 FAULTY AR BLOCK IL1=0.46K A IL2=2.02K A IL3=0.35K A MT86 186 DIST=5.1 KM	NIL	TRANSIENT LINE FAULT	TLF	Informed to O&M wing for required action
CB NO.78 CHUDIYALA LINE	SIEMENS	21-07-2023 17:13	21-07-23 17:22	CP-MTR OPTD DIST PROTN OPTD RP-LED-1,4,5,9 DIST=6.3KM IL1=0.34KA IL2=0.18KA IL3=4.27KA 50Z/LBB PROTN OPTD	DIST PROTN OPTD RP- MTR 86-1 MTT 86-2 TRIP IA=IB=0 IC=2991.7 A TRIP OTHER PHASE C NEUTRAL GND LED GRP- 1 GND DIST Z1 OPTD LED GRP- 2 A/R BLOCK	NIL	TRANSIENT LINE FAULT	TLF	Informed to O&M wing for required action
CB NO.77 LSM	SIEMENS	22-07-2023 13:18	22-07-23 13:33	CP-MTR OPTD DIST PROTN START DIST PROTN OPTD RP-DIST PROTN RELAY LED-1,2,5,9 DIST=2.3KM IL1=6.05KA IL2=0.05KA IL3=0.04KA POLE OPEN L1 MTR 186	NA	NIL	TRANSIENT LINE FAULT	TLF	Informed to O&M wing for required action

Name of Feeder/TF	Type of	Date Time of Tripping	Date & Time of closing	flags observed	Other end flage	affected generation/load	Tripping Analysis / Action taken report	Category Code	Action Taken
20MVA T/F 1ST 783/683	SIEMENS	24-07-2023 12:00	24-07-23 12:21	O/C E/F OPTD LED=1,5 IL1=731A IL2=100.9A IL3=60.83A 86-1,86-2 LBB TRIPPING 50ZX 83DC	NA	NIL	DUE TO HEAVY CURRENT	TLF	Informed to O&M wing fpr required action
20MVA T/F 2ND 784/684	SIEMENS	24-07-2023 12:00	24-07-23 12:21	O/C E/F OPTD LED=1,5 IA=703A IB=99.1A IC=59.80A 86-1 86-1 LBB TRIPPING 50ZX 80DC	NA	NIL	DUE TO HEAVY CURRENT	TLF	Informed to O&M wing fpr required action
CB NO. 72 SIDCUL	SIEMENS	02-08-2023 05:52	02-08-2023 05:52	CP- DIST PROTN OPTD MTR OPTD DIST PROTN START RP-DIST PROTN LED- 1,4,5,9 DIST PICKUP L3 E DIST=11.8% IL1=0.15KA IL2=0.26KA IL3=4KA	CP- BACKUP RELAY DIR. O/C OPTD E/F OPTD RP-MAIN 3 PHASE TRIP RELAY 86-1 MAIN 3 PHASE TRIP RELAY 2 86-2	NIL	TRANSIENT LINE FAULT	TLF	Informed to O&M wing fpr required action
CB NO.71 JWALAPUR	SIEMENS	03-08-2023 18:09	03-08-2023 18:25	CP-MTR OPTD DIST PROTN OPTD RP-50Z/LBB PROTN RELAY LED-1,2 DIST=43.22KM IA=0 IB=4.173A IC=2.44KA MTR 186	NA	NIL	TRANSIENT LINE FAULT	TLF	Informed to O&M wing fpr required action
785/685 20 MVA T/F 3	SIEMENS	14-08-2023 16:01	14-08-2023 16:11	CP-LV BACKUP PROTN OPTD RP-O/C PU ON O/C E/F PU ON RELAY TRIP ON O/C TRIP ON IL1=0.06KA IL2=0.05KA IL3=1.24KA	NA	NA	CB 67 66KV SAHARANPUR BREAKER DOESN'T TRIP DUE TO BREAKER PROBLEM	SEM T	Informed to O&M wing fpr required action
CB NO.74 MANGLORE LINE	SIEMENS	22-08-2023 11:02	22-08-2023 11:17	CP-MTR OPTD DIR O/C E/F PROTN OPTD DIST PROTN START RP-DIST PROTN RELAY LED-1,4 DIST PICKUP L3E DIST LOOP L3-E DIST=39KM IA=263.7A IB=98.01A IC=6.122KA MTR186	CP-DIST RELAY TRIP DIST PROTN RELAY START	NIL	TRANSIENT LINE FAULT	TLF	Informed to O&M wing fpr required action



Name of Feeder/TF	Type of	Date Time of Tripping	Date & Time of closing	flags observed	Other end flage	affected generation/load	Tripping Analysis / Action taken report	Category Code	Action Taken
CB NO.71 JWALAPUR	SIEMENS	22-08-2023 20:11	22-08-2023 20:42	CP-DIST PROTN START MTR OPTD DIR O/C E/F PROTN OPTD RP-DIST PROTN RELAY LED-3,4 ZONE 1 DIST=44.09KM MTR 186 IA=3.580A IB=6.05A IC=2.527KA IN=2.52KA	NA	NIL	TRANSIENT LINE FAULT	TLF	Informed to O&M wing fpr required action
CB NO.78 CHUDIYALA	SIEMENS	25-08-2023 02:30	25-08-2023 11:57	NO FLAG OBSERVED	NA	NIL	DUE TO PROBLEM IN CABLE (REMOTE TRIPPING CONTINUOUSLY)	SEFT	Informed to O&M wing fpr required action
160MVA T/F-2 CB NO. 888	ALSTOM	26-08-2023 23:24	27-08-2023 01:35	CP-BREAKER TROUBLE TRANS F TROUBLE ALARM RP-BUCHHOLZ WTI ALARM 30 1/2 OTI/ PRV ALARM H1/2 CB TRIP L/O OIL PR SF-6 OIL/ 1/2 30 A 1/2 CB AUTO TRIO BUS SEL INCORRECT 30 D 1/2 CB DC 1/2	NA	NA	Water logged in the trench caused cable fault	SEMT	Informed to O&M wing fpr required action
160MVA T/F-2 CB NO. 889	ALSTOM	27-08-2023 02:07	27-08-2023 03:20	BREAKER PD TRIP ALARM	NA	NIL	Water logged in the trench caused cable fault	SEMT	Informed to O&M wing fpr required action
CB NO.72 SIDCUL LINE	SIEMENS	29-08-2023 10:44	29-08-2023 11:07	MTR OPTD DIST PROTN START DIR O/C E/F PROTN OPTD LED=2,3 DIST=2KM IA=1.99KA IB=351.4A IC=426.7A MTR 186 LED=4	NA	NIL	BUS FAULT AT 132KV BUS	SEMT	Informed to O&M wing fpr required action
160 MVA T/F L,2 887/787 888/788	ALSTOM	29-08-2023 10:44	29-08-2023 11:08	CP-BREAKER TC 1/2 787- IA=3.659kA IB=523.2A IC=206.3A VAN=4.038KV VB=70.77KV VCN=69.02KV 788- IA=3.560kA IB=522.3A IC=210.9A IN=3.797A MTR 86 ACTIVE GRP-1	NA	NIL	BUS FAULT AT 132KV BUS	SEMT	Informed to O&M wing fpr required action
CB NO.788 160MVA T/F-2	ALSTOM	05-09-2023 12:41	05-09-2023 12:55	CP-BREAKER T/C FAULTY O/C E/F 86 OPTD RP-86OPTD AUTO TRIP IA=480.3A IB=624.6A IC=1.285KA FD=2.729ms	NA	NIL	DUE TO BUS FAULT AT SIDCUL		Informed to O&M wing fpr required action

Name of Feeder/TF	Type of	Date Time of Tripping	Date & Time of closing	flags observed	Other end flage	affected generation/load	Tripping Analysis / Action taken report	Category Code	Action Taken
CB. NO 71 JWALAPUR	SIEMENS	05-09-2023 12:42	05-09-2023 13:02	CP-MTR OPTD DIR O/C E/F PROTN OPTD RP-LED 3 IA=35.10A IB=69.57A IC=243.4A 50Z/LBB RELAY TRIP MTR 186 TRIPPED	NA	NIL	TRANSIENT LINE FAULT	TLF	Inform ed to O&M wing fpr requir ed action
CB NO.72 SIDCUL LINE	SIEMENS	06-09-2023 19:38	06-09-2023 19:59	CP-DIST PROTN OPTD DIST PROTN START MTR OPTD RP-IA=0.08KA IB=0.10KA IC=3.20KA DIST=15.3KM D=57.5% LED=1,4,5,9 MTR 186 OPTD 50Z/LBB RELAY OPTD	RP=BACK UP RELAY DIR O/C OPTD MAIN 3 PHASE TRIP RELAY OPTD 86- 1,2 IA=0.07K A IB=0.08K A IC=4.37K A	NIL	TRANSIENT LINE FAULT	TLF	Inform ed to O&M wing fpr requir ed action
CB NO.83 PUHANA LINE	ALSTOM	08-09-2023 2:25	08-09-2023 2:47	CP-BREAKER AUTO TRIP DIRECT TRIP RECEIVED RP-27R 27Y 27B DIST /DT CARRIER RCVD 85 X/Z 3PH PRTON TRIP THROUGH-21 DIST TRIP 86A 86B 86C CB AUTO TRIP TRIP 86 A SPARE AUX RELAY 30E 1/2 AUX TO 50ZX 86X ACTIVE GRP1 STARTED PHASE C TRIP PHASE ABC DIST TRIP Z2 DIST=9.641KM IA=4.556A IB=4.066A IC=2.916KA FAULT IN Z2	NA	NIL	TREE CAME IN THE RANGE	TLF	Inform ed to O&M wing fpr requir ed action
CB NO.83 PUHANA LINE	ALSTOM	08-09-2023 02:47	08-09-2023 09:08	CP-BREAKER AUTO TRIP DIRECT TRIP RECEIVED RP-27R 27Y 27B DIST /DT CARRIER RCVD 85 X/Z 3PH PRTON TRIP THROUGH-21 DIST TRIP 86A 86B 86C CB AUTO TRIP TRIP 86 A SPARE AUX RELAY 30E 1/2 AUX TO 50ZX 86X ACTIVE GRP1 STARTED PHASE C TRIP PHASE ABC DIST TRIP Z2 DIST=8.922KM IA=4.231A IB=0A IC=2.966KA FAULT IN Z2	NA	NIL	TREE CAME IN THE RANGE	TLF	Inform ed to O&M wing fpr requir ed action

Name of Feeder/TF	Type of	Date Time of Tripping	Date & Time of closing	flags observed	Other end flage	affected generation/load	Tripping Analysis / Action taken report	Category Code	Action Taken
CB NO.71 JWALAPUR LINE	SIEMENS	09-09-2023 22:54	09-09-2023 23:11	CP-MTR DIST PROTN OPTD MTR 186 LED=2,4 IA=75.60A IB=2.393KA IC=52.41A	CP-DIST PROTN OPTD CARRIER FAIL RP-3 PHSE TRIP RELAY-1 86-1 3 PHASE TRIP RELAY- 2(86-2) DIST=17.9 KM IA=0.15K A IB=3.16K A IC=0.09K A PICKUP TIME=86 ms	NIL	TRANSIENT LINE FAULT	TLF	Informed to O&M wing fpr required action
CB NO.71 JWALAPUR LINE	SIEMENS	11-09-2023 20:20	11-09-2023 20:32	CP-MTR OPTD DIST PROTN OPTD RP-Z1 TRIPPED IA=1.79KA IB=37.95A IC=40.15A LED=1,4 DIST=50.71KM 50Z/LBB	MAIN RELAY DIST PROTN OPTD BACKUP RELAY DIR. O/C OPTD RP-DIST PICKUP L1E-2 PICKUP TIME=70 ms TRIP TIME=1m s DIST=13K M IA=3.81K A IB=0.07K A IC=0.08K A MAIN 3 PHASE TRIP RELAY 86-1,2	NIL		TLF	Informed to O&M wing fpr required action

Name of Feeder/TF	Type of	Date Time of Tripping	Date & Time of closing	flags observed	Other end flage	affected generation/ load	Tripping Analysis / Action taken report	Category Code	Action Taken
CB NO.71 JWALAPUR LINE	SIEMENS	12-09-2023 01:22	12-09-2023 01:35	CP-MTR OPTD DIST PROTN OPTD RP-Z1 TRIPPED IA=1.79KA IB=36.92A IC=439.40A LED=1,4 DIST=50.86KM 50Z/LBB	MAIN RELAY DIST PROTN OPTD BACKUP RELAY DIR. O/C OPTD RP-1,4,5,6 ANY TRIP B PHASE TRIP Z1 TRIP Z2 TRIP DIST=13K M IA=3.82K A IB=0.07K A IC=00.007 KA 50/51 P TRIP 50/51 G TRIP 86-1 ,2 (MAIN 3 PHASE TRIP RELAY)	NIL	NA	TLF	Informed to O&M wing for required action
CB NO 81 NARA	MICOM	16-09-2023 15:47	16-09-2023 16:42	CP-A/R LOCKOUT POLE DEAD BREAKER AUTO TRIP RP-86A 86B 86C MTR 86 86X CB AUTO TRIP Z1 FL=948m IN=639.4A IA=250.9A IB=170.2A IC=343A	NA	NIL	NA	NA	Informed to O&M wing for required action
CB NO 72 SIDCUL LINE	SIEMENS	17-09-2023 12:36	17-09-2023 12:51	MTR OPTD DIST PRTN START DIST PROTN OPTD LED=1,3,4,9 MTR-186 IA=0.29A IB=3.35KA IC=0.27KA DIST=12.1KM	BACKUP RELAY DIST O/C DIR E/F OPTD RP-TRIP 86-1 86-2 50/51 P TRIP 50/51 G TRIP BACKP 67/67N IA=0.27A IB=4.44K A IC=2.7A	NIL	TRANSIENT LINE FAULT	TLF	Informed to O&M wing for required action

Name of Feeder/TF	Type of	Date Time of Tripping	Date & Time of closing	flags observed	Other end flage	affected generation/ load	Tripping Analysis / Action taken report	Category Code	Action Taken
CB NO.81 NARA LINE	ALSTOM	18-09-2023 03:35	18-09-2023 04:32	CP-A/R LOCKOUT POLE DEAD BREAKER AUTO TRIP RP-86A 86B 86C MTR 86 86X CB AUTO TRIP Z1 F.L=20.43mm	NA	NIL			Informed to O&M wing fpr required action
CB NO.72 SIDCUL LINE	SIEMENS	22-09-2023 05:52	22-09-2023 06:20	MTR OPTD DIST PROTN OPTD LED=1,3,9 MTR- 186 IA=0.18KA IB=3.56KA IC=0.11KA DIST=13.7KM	CP- BACKUP RELAY DIR O/C OPTD BACKUP RELAY DIR E/F CB OPEN TRIP 50/51 R TRIP 50/51G TRIP RP-MAIN 3 PHASE TRIP RELAY-1 (86-1) MAIN 3PHASE TRIP RELAY-2 (86-2) DIS=20.4 KM IA=IC=0 KA IB=3.87K A	NIL	TRANSIENT LINE FAULT	TLF	Informed to O&M wing fpr required action
CB NO. 81 NARA LINE	MICOM	22-09-2023 18:09	22-09-2023 19:06	CP-A/R LOCKOUT POLE DEAD BREAKER AUTO TRIP RP-Z1 YN TRIP R TRIP CARRIER SEND DIST 86A 86B 86C PROTN TRIP 21X VA=7.59KV VN=181.1KV MTR-86 TRIP CB AUTO TIP SPARE AUX RELAY FD=6.2KM IN=608.4A IA=251.4A IB=160.3A IC=350.7A	NA	NIL	NA	NA	Informed to O&M wing fpr required action
CB NO. 67 SAHARANPUR	SIEMENS	22-09-2023 10:51	22-09-2023 11:01	DIST PROTN RELAY LED=1,3,5 DIST PICKUP L2E DIST LOOP L2E DIST=57.31KM DIST=132.6% O/C E/F RELAY LED=2,5,6 IA=34.89A IC=53.37A IB=1.175KA MTR 86	NA	NIL	TRANSIENT LINE FAULT	TLF	Informed to O&M wing fpr required action

Name of Feeder/TF	Type of	Date Time of Tripping	Date & Time of closing	flags observed	Other end flage	affected generation/ load	Tripping Analysis / Action taken report	Category Code	Action Taken
CB NO. 71 JWALAPUR	SIEMENS	30-09-2023 00:25	30-09-2023 00:50	CP-MTR OPTD DIR O/C PROTN OPTD LBB OPTD RP-LED-3 IA=75.78A IB=52.68A IC=410.4A MTR 86	NA	NIL	Transient earth fault	Tlf	Informed to O&M wing fpr required action
CB NO. 72 SIDCUL	SIEMENS	30-09-2023 00:25	30-09-2023 01:14	CP-MTR OPTD DIST PROTN OPTD DIST PROTN START RP-12.9KM LED=1,4,5,9 DIST RELAY	NA	NIL	Transient earth fault	Tlf	Informed to O&M wing fpr required action
CB NO. 72 SIDCUL LINE	SIEMENS	02-10-2023 19:07	02-10-2023 19:30	CP-LED 1, 4,5,9 IA=0.15KA IB=0.19KA IC=3.51KA DIST=12.9KM DEFINITIVE TRIP	CP- BACKUP RELAY DIR O/C OPTD RP-50/51P TRIP 50/51G TRIP TRIP RELAY 86-1,2 IA=0.14K A IB=0.18K A IC=3.86K A	NIL	TRANSIENT LINE FAULT	TLF	Informed to O&M wing fpr required action
CB NO. 73 ROORKEE	SIEMENS	04-10-2023 03:44	04-10-2023 04:02	MTR DIST PROTN START DIST PROTN OPTD LED=1,4,2 DIST=15.4KM IA=0.10KA IB=3.40KA IC=0.09KA	CP- BACKUP ELAY DIR O/C OPTD DIR E/F OPTD RP-MAIN 3 PHASE TRIP 86-1 86-2 50/51 TRIP 50/51 G TRIP IA=0.08K A IB=4.50K A IC=0.08K A	NIL	TRANSIENT LINE FAULT	TLF	Informed to O&M wing fpr required action

Name of Feeder/TF	Type of	Date Time of Tripping	Date & Time of closing	flags observed	Other end flage	affected generation/load	Tripping Analysis / Action taken report	Category Code	Action Taken
CB NO. 81 NARA LINE	MICOM	04-10-2023 23:44	05-10-2023 00:58	CP-A/R LOCKOUT POLE DEAD BREAKER AUTO TRIP RP-R PHASE U/V FOR 27R XB A PHASE DIST TRIP 86ABC DIST RELAY LED 1,2,3,4 ACTIVE GRP 1 FD=40ms RTT=00 DIST=3.353mm IA=133.5A IB=325.7A IC=238.8A IN=608.1A VA=144.1KV VB=146.4KV VC=5.611KV MTR 86 CB AUTO TRIP	NA	NIL	TRANSIENT LINE FAULT	TLF	Informed to O&M wing fpr required action
40MVA T/F 3RD	SIEMENS	04-10-2023 15:18	04-10-2023 15:30	CP-HV O/C E/F PROTN RELAY OPTD 186 HL TRIPPED RP-67/67N(HV) LED=1,4,5 50Z/LBB HV 186 LV SIDE 186 TRIPPED	NA	NIL	TRIPPED WITH 33KV FEEDER HG HOUSE	TLF	Informed to O&M wing fpr required action
CB NO.783/683 20MVA 1ST	SIEMENS	07-10-2023 16:23	07-10-2023 16:35	DIFF PICKUP 30C RELAY OPTD MTR 86H/L	NA	NIL	TRIPPED WITH CB NO.62	SEFT	Informed to O&M wing fpr required action
CB NO 72 SIDCUL LINE	SIEMENS	12-10-2023 07:57	12-10-2023 08:18	CP-MTR OPTD DIST PROTN START DIST PROTN OPTD LED=1,3,5,9 DIST=10.5KM MTR 186 IA=0.22KA IB=4.34KA IC=0.18KA	CP- BACKUP RELAY DIR O/C OPTD BACKUP DIST E/F OPTD RP-50/51P TRIP 50/51G TRIP DIST=100 TRIP RELAY-2 IA=0.20K A IB=4.02K A IC=0.18K A	NIL	TRANSIENT LINE FAULT	TLF	Informed to O&M wing fpr required action

Name of Feeder/TF	Type of	Date Time of Tripping	Date & Time of closing	flags observed	Other end flage	affected generation/ load	Tripping Analysis / Action taken report	Category Code	Action Taken
CB NO 73 LAKSAR LINE	SIEMENS	14-10-2023 04:56	14-10-2023 05:23	CP-MTR OPTD DIST PROTN START DIST PROTN OPTD RP-DIST LOOP L3-E ON DIST TRIP 3P ON DIST TRIP Z3/T3 ON IA=0.09KA IB=0.12KA IC=3.45KA POLE OPEN L3 ON DIST=124.2KM MTR	CP-DIST PROTN OPTD MTR OPTD DIST PROTN START A/R BLOCKE D RP-G TRIP B PHASE PICKUP Z1 FAULT A/R BLOCK 186,86	NIL	TRANSIENT LINE FAULT	TLF	Inform ed to O&M wing fpr requir ed action
CB NO 72 SIDCUL LINE	SIEMENS	17-10-2023 10:34	17-10-2023 10:57	CP-MTR OPTD DIST PROTN OPTD DIST PROTN START DIST RELAY LED=1,4,5,9 IA=0.17KA IB=0.18KA IC=3.90KA DIST=11.5KM 50Z/LBB OPTD 186 OPTD	CP- BACKUP RELAY DIR O/C OPTD BACKUP DIR E/F OPTD IA=0.17K A IB=0.17K A IC=4.10K A 50/51P TRIP 50/51 G TRIP MAIN 3PHASE 1,2 TRIP	NIL	TRANSIENT LINE FAULT	TLF	Inform ed to O&M wing fpr requir ed action
CB NO.72 SIDCUL	SIEMENS	05-11-2023 00:05	05-11-2023 00:25	CP-MTR OPTD DIST PROTN OPTD DIST PROTN START RP-DIST PROTN RELAY LED=1,4,5,9 DIST=15.4KM DIST LOOP L3-E DIST PICKUP L3E IA=0.11KA IB=0.17KA IC=3.52KA DIST=57.9% 50Z/LBB PROTN RELAY LED=1,2 MTR 186	CP- BACKUP RELAY DIR O/C OPTD BACKUP DIR E/F OPTD IA=0.12K A IB=0.15K A IC=5.38K A MAIN 3PHASE RELAY 1,2	NIL	TRANSIENT LINE FAULT	TLF	Inform ed to O&M wing fpr requir ed action



Name of Feeder/TF	Type of	Date Time of Tripping	Date & Time of closing	flags observed	Other end flage	affected generation/ load	Tripping Analysis / Action taken report	Category Code	Action Taken
CB NO 74 MANGLORE	SIEMENS	10-11-2023 14:15	10-11-2023 16:26	CP-FLAG MTO DPO PPS RP-DIST=8.2KM IA=9.19KA IB=0.24KA IC=0.40KA 50Z/LBB Z1 TRIPPED	CP-DIST RELAY TRIP DIST PROTN RELAY STARTED RP-REX 511 Z1,2,3,4 START TOC STL- 1 DIST=7.6 KM IA=2146A IB=1.94K A IC=2.27K A	NIL	TRANSIENT LINE FAULT	TLF	Inform ed to O&M wing fpr requir ed action
CB NO 73 LAKSAR	SIEMENS	12-11-2023 18:21	12-11-2023 18:35	TRIPPED ON MTR DIST PROTN START DIST PROTN OPTD DIST=142.9KM LED=1,3,7 IA=0.11KA IB=3.10KA IC=0.08KA MTR86	CP-DIST PROTN OPTD START A/R BLOCKE D MTR OPTD RP-86,186 B PHASE START LOOP L2E DIST=4.1 KM IA=0.52K A IB=2.13K A IC=0.43K A	NIL	TRANSIENT LINE FAULT	TLF	Inform ed to O&M wing fpr requir ed action
CBNO.83 PUHANA	MICOM	05-12-2023 12:30	05-12-2023 20:15	CP-DIR TRIP CB AUTO TRIP RP-DIST R,Y,B DIST CARRIER R,B DIST=11.03KM IA=4.219A IB=0 IC=3.309KA VAN=125.1KV VBN=101.7KV VCN=33.88KV Z2 86 TRIP	NA	NIL	Y PHASE LA DAMAGE (FROM OTHER END)	SEF T	Inform ed to O&M wing fpr requir ed action

Name of Feeder/TF	Type of	Date Time of Tripping	Date & Time of closing	flags observed	Other end flage	affected generation/load	Tripping Analysis / Action taken report	Category Code	Action Taken
CBNO.81 NARA	MICOM	06-12-2023 03:47	06-12-2023 04:47	CP-A/R LOCKOUT BREAKER AUTO TRIP RP-R PHASE U/V FOR E/S INTERLOCKING 27R 3 PHASE PROTN TRIP 21X DIST PROTN 21 LED=5 RYB PHASE Z1 DIST TRIP Z1 A/R STATE TRIP FD=31ms DIST=2.402KM CBOT=26ms IA=250.4A IB=151.5A IC=279.9A IN=650A VA=4.876KA VB=153KV VC=147.3KB APHAUSE DIST TRIP 86A 86B 86C CB AUTO TRIP	NA	NIL	TRANSIENT LINE FAULT	TLF	Informed to O&M wing fpr required action
CBNO.81 NARA	MICOM	06-12-2023 06:36	06-12-2023 08:23	CP-A/R LOCKOUT BREAKER AUTO TRIP RP-R PHASE U/V FOR E/S INTERLOCKING 27R 3 PHASE PROTN TRIP 21X DIST PROTN 21 LED=5 RYB PHASE Z1 DIST TRIP Z1 A/R STATE TRIP FD=35ms DIST=3.705KM CBOT=30ms IA=237.9A IB=149.2A IC=325.1A IN=644.3A VA=5.271KV VB=152.4KV VC=145.3KV VN=191.2KV A PHASE DIST TRIP 86A 86B 86C AUTO TRIP	NA	NIL	TRANSIENT LINE FAULT	TLF	Informed to O&M wing fpr required action
CBNO.81 NARA	MICOM	13-12-2023 02:05	13-12-2023 03:16	CP-A/R LOCKOUT BREAKER AUTO TRIP RP-27R 27Y 27B 3 PHASE PROTN TRIP THROUGH 21 CB AUTO TRIP SPARE AUX RELAY 30 E 1/2 RIGHT TRIP RELAY 86 86X DIST TRIP Z1 FD=11ms DIST=3.228mm IA=125.3A IB=275.5A IC=240.3A VA=145.8KV VB=149.4KV VC=6.385KV VN=183.4KV	NA	NIL	TRANSIENT LINE FAULT	TLF	Informed to O&M wing fpr required action
CBNO.81 NARA	MICOM	14-12-2023 01:09	14-12-2023 02:23	CP-A/R LOCKOUT BREAKER AUTO TRIP 86A 86B 86C B PHASE U/V E/S INTER LOCKING 27B 3 PHASE PROTN TRIP 21X TRIP 86 CB AUTO TRIP DIST PROTN 21 LED=1,2,,3,4 DIST TRIP Z1 FD=20ms CBOT=15ms RTT=0 DIST=3.828Mm IA=127.8A IB=286.5A IC=241.5A IN=617.9A VA=146.7KV VB=150KV VC=6.468KV VN=183.7KV	NA	NIL	TRANSIENT LINE FAULT	TLF	Informed to O&M wing fpr required action

Name of Feeder/TF	Type of	Date Time of Tripping	Date & Time of closing	flags observed	Other end flage	affected generation/load	Tripping Analysis / Action taken report	Category Code	Action Taken
CBNO.81 NARA	MICOM	22-12-2023 05:44	22-12-2023 06:53	CP-A/R LOCKOUT POLE DEAD BREAKER AUTO TRIP RP-DIST TRIP 86A 86B 86C 3 PHASE PRTON TRIP THROUGH 21 21X BUS SELECTION INCORRECT 30D 1/2 SPARE AUX RELAY 30 E 1/2 TRIP RELAY 86,86X DIST PROTN Z1 IA=121.5A IB=309.6A IC=231.1A IN=608.9A VA=143.8KV VB=147.1KV VC=5.028KV VN=181.8KV	NA	NIL	TRANSIENT LINE FAULT	TLF	Informed to O&M wing for required action
CB NO. 71 JWALAPUR	SIEMENS	23-12-2023 01:14	23-12-2023 01:26	CP-MTR OPTD DIST PROTN OPTD RP-DIST TRIP Z1 DIST=28.98KM LED=3,4 MTR 186 FD=55ms CBOT=50ms RTT=0sec IA=233.5A IB=190.3A IC=3.494KA VA=87.77KV VB=52.32KV VC=83.29KV	CP- BACKUP RELAY DIR O/C E/F OPTD RP-DIST LOOP L3E EF TRIP BLOCK B 50/51 P TRIP 50/51G TRIP IA=00 IB=00 IC=3.75 86	NIL	TRANSIENT LINE FAULT	TLF	Informed to O&M wing for required action
CBNO 781/381 782/382 786/386	SIEMENS	01-02-2024 02:55	01-02-2024 03:31	781/381-HV O/C E/F OPTD 186H TRIP RELAY OPTD 186L TRIP RELAY OPTD RP-MT1 R86 782/382-CP-LV TC/TC2 FAULTY RP-RELAY PICKUP OK IA=0.06KA IB=0.22KA IC=0.01KA HV 186 LV 186 786/386-CP-HV O/C E/F OPTD 186H TRIP RELAY OPTD 186L TRIP RELAY OPTD RP-IA=0.11KA IB=0.42KA IC=0.01KA HV 186 LV 186	NA	NIL	TRIPPED WITH BEHEDHKI (BLAST IN CABLE BOX OF BEHDHKI)	SEM T	Informed to O&M wing for required action

## 5.0. Observations and Recommendations

### 5.1. Reporting of all the Tripping with DR/EL

- a. For the interstate lines, as per IEGC clause 37.2(c) and clause 15.3 of CEA grid standard, all the DR/EL reports shall be uploaded on Web Based Tripping Monitoring System “http://103.7.128.184/Account/Login.aspx” within 24 hours of the events. These are being submitted by sub-station to NRLDC portal, however the record of the same is not kept at substation level.

Status of submission of FIR/DR/EL/Tripping Report on NR Tripping Portal																		
Time Period: 1st January 2024 - 31st January 2024																		
S. No.	Utility	Total No. of tripping	First Information Report (Not Received)		Disturbance Recorder (Not Received)		Disturbance Recorder (NA) as informed by utility		Event Logger (Not Received)		Event Logger (NA) as informed by utility		Tripping Report (Not Received)		Tripping Report (NA) as informed by utility	Tripping Report (Not Received)	Remark	
			Value	%	Value	%	Value	%	Value	%								
36	SLDC-PS	29	2	7	13	6	57	13	5	54	15	0	55					
37	SLDC-RS	130	12	9	23	11	19	23	9	15	39	0	36					DR, EL & Tripping report need to be submitted
38	SLDC-UK	6	0	0	0	4	0	0	4	0	1	3	33					
39	SLDC-UP	80	10	13	11	9	15	12	30	17	11	1	14					
40	STERILITE	1	0	0	0	0	0	0	0	0	0	1	0					Details received
41	TANAKPUR-NH	4	1	25	1	0	25	1	0	25	1	0	25					DR, EL & Tripping report need to be submitted
42	LINCHAHAR-NT	1	0	0	0	0	0	0	1	0	0	0	0					Details received
Total in NR Region		520	147	28	168	69	37	171	70	38	185	17	37					

*As per the IEGC provision under clause 37.2 (c), detailed tripping report along with DR & EL has to be furnished within 24 hrs of the occurrence of the event*

Ref: NRPC 216 OCC Agenda (Annexure B.VIII)

- b. For the tripping of intra-state lines, the brief tripping reports are submitted to Divisional office. The DR/EL reports are downloaded by respective officials and forwarded, as per need basis. The record of these DR/EL is not kept at sub-stations
- c. It is recommended that each sub-station to have a central repository of such tripping reports, along with DR/EL reports and analysis. A dedicated PC can be kept for this.

### 5.2. Development of centralized database of relay settings

- a. In 48th TCC & 70th NRPC Meeting (held on 17-18 Nov 2023), NRPC Committee has approved for development of a portal through PSDF for Centralized database containing details of relay settings for grid elements connected to 220 kV and above. Portal shall have other features including protection setting calculation tool. A nodal officer shall be providing this data at central portal.
- b. The relay settings for below 220kV are to be calculated by SLDC and/or central level. The relays are tested by sub-station officials as per need basis, but the record of recommended

settings/ calculation is not kept at sub-station level. This makes it difficult to validate the settings and test results, in case of relay testing.

- c. It is recommended that latest recommended relay settings, as decided by RLDC for 220kV & above and by SLDC below 220kV along with setting calculations & parameters used for all the relays be kept at sub-station level. This will help in proper fault analysis and ascertaining relay healthiness.

### ***5.3. Review of test results of relay and equipment***

- a. Testing of most of the equipment is carried out, as per availability of shut-down and testing equipment. After testing, the test records are summarily recorded in testing register, with remarks as “tested. OK”.
- b. For the numeric relay testing, the testing is carried out by supplier at the time of installation and subsequently as per need basis, including at the time of change in settings.
- c. A draft O&M manual is available at PTCUL web-site, which includes various tests and their frequency, along with results. This manual is based on CERC/SERC regulations of 2004-2008. It is recommended that this manual may be updated and implemented and record of test values may be kept for future reference.

### ***5.4. Availability of Testing Kits***

- a. The availability of testing equipment is limited at each substation. For comprehensive testing of equipment, as per above para, sufficient testing kits at each substation/Sub-division/Division level are required.
- b. Based on the O&M manual, it is recommended that sufficient quantity of testing instruments be made available at sites for regular testing of equipment. A suggested list of Testing Equipment is attached at Annexure – 1.

### ***5.5. Up-dation of PTCUL Protection Philosophy***

The protection philosophy adopted by Utility, in general, is in alignment with protection philosophy adopted by NRPC. As the NRPC has recently updated the protection philosophy, PTCUL in consultation with SLDC may update protection philosophy for network not covered by NRPC, if needed, and implement the same.

### ***5.6. Simulation based study of protection system***

As per IEGC, protection code, during audit the relay settings to be adopted shall be validated with simulation based or EMTP studies and details shall be enclosed in report. The current scope of audit was excluding these studies, therefore, Simulation based or EMTP Studies should be carried out by the Utility, as per the requirement of Grid Code.

### ***5.7. Capacity Building of protection team***

During the discussions with officials at site, it was observed that the teams responsible for the protection system and SAS, needs to be updated on current trends on protection system, communication schemes and Sub-station automation. Utility may undertake capacity building exercise for the officials involved in these activities.

### ***5.8. Updated Fault Level/ Short Circuit Level and Network information***

The fault level/ short circuit level for each substation is being calculated at central level. Such studies are carried out, as and when new elements are added in the network. This has impact on relay settings parameters and equipment ratings. It is recommended that the updated network information and short circuit level be maintained at central level for revising the setting as per requirement.

### ***5.9. General Protection related observations***

The study of Fire protection system/ Nitrogen Injection Fire Protection System, Lightning Protection system, Earthing Mat/ Earthing Protection are not covered under protection audit. Utility may get a comprehensive technical and safety audit carried out internally or thru third party and corrective action for any discrepancy be taken up accordingly.

### ***5.10. O&M Manual***

The Utility has a draft O&M manual uploaded on its website, which is being referred by working level officials as a guideline for regular O&M and testing functions. This manual needs to be updated to incorporate recent developments and approved for regular use in all sub-stations to bring uniformity in O&M and testing practices across the utility.

## **6.0. Station Specific Observation and Recommendations**

### **6.1. Protection related observations and recommendations**

- a. The major observations and recommendations of the previous audit report are to be complied with.
- b. Bus Bar Protection on 220kV Bus is not functional after addition of the new elements with the 220kV bus. It is recommended to make it functional.
- c. PLCC is unhealthy and therefore tele protection is out of service and both the 220kV circuits are operating without carrier protection, however the auto reclosure is enabled. Currently the successful auto reclosures are being recorded in the log book however no separate analysis record is being maintained. Record of successful auto-reclosures be maintained along with tripping reports.
- d. The events are recorded from individual relays, no separate Event Logger is provided. The SAS has the event logging capability but is not in regular use. It is observed that some of the inputs are not available at SAS. The effectiveness of SAS can be improved by using SAS regularly. Therefore, update and upkeep of SAS is recommended.
- e. 3 nos. GPS Time Synchronization Systems are provided in the substation. One system caters to SAS and other two caters to relays and other equipment's of the respective substation i.e. old 132 kV. Only one GPS associated with 220kV site is functional, but the relays are connected to SAS GPS, therefore presently no relay is time synchronised. Necessary corrective actions need to be taken.

### **6.2. Equipment related observations and recommendations**

- a. The switchyard equipments are generally in good condition. Any requirement of spare equipment may be reviewed by PTCUL.
- b. In addition, it is recommended that sufficient quantity of maintenance equipments be made available at sites. A suggested list of Maintenance Equipment is attached at Annexure– 3.

### **6.3. Auxiliary Equipment related observations and recommendations**

- a. Both the 110V DC systems are showing earth-fault. Corrective actions need to be taken.
- b. Protection maloperations due to waterlogging in switchyard are observed. Necessary action for avoiding water logging and consequential maloperation of protective system needs to be taken.

## Annexure – 1: Suggested List of Testing Instruments

CBIP suggests the following list of testing instruments based on the approved O&M manual

Sl. No.	Testing Instruments
1	DCRM for Circuit Breaker
2	DC Earth Fault Locator
3	SF6 Gas Density Monitor
4	SF6 Gas Leakage detector/ Imaging Camera
5	CB Analyser
6	Earth Resistance Tester
7	Portable Digital Selective Level Meter cum Level Generator
8	Selective Level Generator
9	LA Leakage Current Analyser
10	Digital Multi-meter
11	Tong Tester
12	Tan Delta Test Kit
13	Digital Leakage Clamp Meter
14	Phase Sequence Indicator
15	Megger (5 kV)
16	Digital Capacitance Meter
17	CT Polarity Tester
18	PT Test Set



## **Annexure – 2: Suggested List of Substation Equipments**

**NIL**

### **Annexure – 3: Suggested List of Maintenance Equipments**

<b>Sl. No.</b>	<b>Equipment</b>
<b>1</b>	Oil Filter Machine
<b>2</b>	SF6 Gas Handling Plant
<b>3</b>	SF6 Gas Density Monitor
<b>4</b>	Thermo-Vision Camera Lines and Sub-Station
<b>5</b>	Binocular Vision Camera
<b>6</b>	SF6 Gas Leakage Imaging Camera
<b>7</b>	LA Leakage Current Analyser
<b>8</b>	Online DGA
<b>9</b>	Oil BDV Kit
<b>10</b>	Hydraulic Crimping Tool for different Types of ACSR Conductor
<b>11</b>	Hydraulic Conductor Cutter
<b>12</b>	Fork Lift 5 Ton Capacity
<b>13</b>	Digital Leakage Clamp Meter

A mobile van with test kits can be kept for optimizing the resources at various substations

## Annexure – 4: Protection Code (IEGC 2023 Chapter 4)

- **General**

1. This chapter covers the protection protocol, protection settings and protection audit plan of electrical systems.
2. There shall be a uniform protection protocol for the users of the grid:
  - a) for proper co-ordination of protection system in order to protect the equipment/system from abnormal operating conditions, isolate the faulty equipment and avoid unintended operation of protection system;
  - b) to have a repository of protection system, settings and events at regional level;
  - c) specifying timelines for submission of data;
  - d) to ensure healthiness of recording equipment including triggering criteria and time synchronization; and
  - e) to provide for periodic audit of protection system.

- **Protection protocol**

1. All users connected to the integrated grid shall provide and maintain effective protection system having reliability, selectivity, speed and sensitivity to isolate faulty section and protect element(s) as per the CEA Technical Standards for Construction, the CEA Technical Standards for Connectivity, the CEA (Grid Standards) Regulations, 2010, the CEA Technical Standards for Communication and any other applicable CEA Standards specified from time to time.
2. Back-up protection system shall be provided to protect an element in the event of failure of the primary protection system.
3. RPC shall develop the protection protocol and revise the same, after review from time to time, in consultation with the stakeholders in the concerned region, and in doing so shall be guided by the principle that minimum electrical protection functions for equipment connected with the grid shall be provided as per the CEA Technical Standards for Construction, the CEA Technical Standards for Connectivity, the CEA Technical Standards for Communication, the CEA (Grid Standards) Regulations, 2010, the CEA (Measures relating to Safety and Electric Supply) Regulations, 2010, and any other CEA standards specified from time to time.

4. The protection protocol in a particular system may vary depending upon operational experience. Changes in protection protocol, as and when required, shall be carried out after deliberation and approval of the concerned RPC.
5. Violation of the protection protocol of the region shall be brought to the notice of concerned RPC by the concerned RLDC or SLDC, as the case may be.

- **Protection settings**

1. RPCs shall undertake review of the protection settings, assess the requirement of revisions in protection settings and revise protection settings in consultation with the stakeholders of the respective region, from time to time and at least once in a year. The necessary studies in this regard shall be carried out by the respective RPCs. The data including base case (peak and off-peak cases) files for carrying out studies shall be provided by RLDC and CTU to the RPCs:
2. All users connected to the grid shall:
  - a) furnish the protection settings implemented for each element to respective RPC in a format as prescribed by the concerned RPC;
  - b) obtain approval of the concerned RPC for,
    - i. any revision in settings, and,
    - ii. implementation of new protection system;
  - c) intimate to the concerned RPC about the changes implemented in protection system or protection settings within a fortnight of such changes;
  - d) ensure correct and appropriate settings of protection as specified by the concerned RPC.
  - e) ensure proper coordinated protection settings.
3. RPCs shall:
  - a) maintain a centralized database and update the same on periodic basis in respect of their respective region containing details of relay settings for grid elements connected to 220KV and above (132KV and above in NER). RLDCs shall also maintain such database.
  - b) carry out detailed system studies, once a year, for protection settings and advise modifications / changes, if any, to the CTU and to all users and STUs of their respective regions. The data required to carry out such studies shall be provided by RLDCs and CTU.

- c) provide the database access to CTU and NLDC and to all users, RLDC, SLDCs, and STUs of the respective regions. The database shall have different access rights for different users.
4. The changes in the network and protection settings of grid elements connected to 220KV and above (132KV and above in NER) shall be informed to RPCs by CTU and STUs, as the case may be.

The elements of network below 66KV and radial in nature which do not impact the National Grid may be excluded as finalized by the respective RPC.

- **Protection audit plan**

1. All users shall conduct internal audit of their protection systems annually, and any shortcomings identified shall be rectified and informed to their respective RPC. The audit report along with action plan for rectification of deficiencies detected, if any, shall be shared with respective RPC for users connected at 220KV and above (132KV and above in NER).
2. All users shall also conduct third party protection audit of each substation at 220KV and above (132KV and above in NER) once in five years or earlier as advised by the respective RPC.
3. After analysis of any event, each RPC shall identify a list of substations / and generating stations where third-party protection audit is required to be carried out and accordingly advise the respective users to complete third party audit within three months.
4. The third-party protection audit report shall contain information sought in the format enclosed as Annexure-1. The protection audit reports, along with action plan for rectification of deficiencies detected, if any, shall be submitted to the respective RPC and RLDC or SLDC, as the case may be, within a month of submission of third-party audit report. The necessary compliance to such protection audit report shall be followed up regularly in the respective RPC.
5. Annual audit plan for the next financial year shall be submitted by the users to their respective RPC by 31<sup>st</sup> October. The users shall adhere to the annual audit plan and report compliance of the same to their respective RPC.
6. Users shall submit the following protection performance indices of previous month to their respective RPC and RLDC on monthly basis for 220KV and above (132KV and above in NER) system, which shall be reviewed by the RPC:
  - e. The Dependability Index defined as

$$D = \frac{N_c}{N_c + N_f}$$

where,

$N_c$  is the number of correct operations at internal power system faults and

$N_f$  is the number of failures to operate at internal power system faults.

- f. The Security Index defined as

$$S = \frac{N_c}{N_c + N_u}$$

where,

$N_c$  is the number of correct operations at internal power system faults

$N_u$  is the number of unwanted operations.

- g. The Reliability Index defined as

$$R = \frac{N_c}{N_c + N_i}$$

where,

$N_c$  is the number of correct operations at internal power system faults

$N_i$  is the number of incorrect operations and is the sum of  $N_f$  and  $N_u$

7. Each user shall also submit the reasons for performance indices less than unity of individual element wise protection system to the respective RPC and action plan for corrective measures. The action plan will be followed up regularly in the respective RPC.
8. In case any user fails to comply with the protection protocol specified by the RPC or fails to undertake remedial action identified by the RPC within the specified timelines, the concerned RPC may approach the Commission with all relevant details for suitable directions.

- **System Protection Scheme (SPS)**

1. SPS for identified system shall have redundancies in measurement of input signals and communication paths involved up to the last mile to ensure security and dependability.
2. For the operational SPS, RLDC or NLDC, as the case may be, in consultation with the concerned RPC(s) shall perform regular load flow and dynamic studies and mock testing for reviewing SPS parameters & functions, at least once in a year.
3. RLDC or NLDC shall share the report of such studies and mock testing including any short comings to respective RPC(s). The data for such studies shall be provided by CTU to the concerned RPC, RLDC and NLDC.
4. The users and SLDCs shall report about the operation of SPS immediately and detailed report shall be submitted within three days of operation to the concerned RPC and RLDC in the format specified by the respective RPCs.
5. The performance of SPS shall be assessed as per the protection performance indices specified in these Regulations. In case, the SPS fails to operate, the concerned User shall take corrective actions and submit a detailed report on the corrective actions taken to the concerned RPC within a fortnight.

- **Recording instruments**

1. All users shall keep the recording instruments (disturbance recorder and event logger) in proper working condition.
2. The disturbance recorders shall have time synchronization and a standard format for recording analogue and digital signals which shall be included in the guidelines issued by the respective RPCs.
3. The time synchronization of the disturbance recorders shall be corroborated with the PMU data or SCADA event loggers by the respective RLDC. Disturbance recorders which are non- compliant shall be listed out for discussion at RPC.

## **Annexure – 5: Third Party Protection System Checking & Validation Template for a Substation (IEGC 2023 Annexure – 1)**

### **1. Introduction:**

- a. The audit reports, along with action plan for rectification of deficiencies found, if any, shall be submitted to RPC or RLDC within a month of submission of report by auditor.
- b. The third-party protection system checking shall be carried at site by the designated agency. The agency shall furnish two reports:
  - i. Preliminary Report: This report shall be prepared on the site and shall be signed by all the parties present.
  - ii. Detailed Report: This report shall be furnished by agency within one month after carrying out detailed analysis.

### **2. Checklist:**

- a. The protection system checklist shall contain information as per this Regulation.
  - i. General Information (to be provided prior to the checking as well as to be included in final report):
    - Substation name
    - Name of Owner Utility
    - Voltage Level (s) or highest voltage level
    - Short circuit current rating of all equipment (for all voltage level) (v) Date of commissioning of the substation
    - Checking and validation date
    - Record of previous tripping's (in last one year) and details of protection operation
    - Previous Relay Test Reports
    - Overall single line diagram (SLD) (x) AC aux SLD
    - DC aux SLD
    - SAS architecture diagram
    - SPS scheme implemented (if any)



b. The preliminary report shall inter-alia contain the following:

**FORMAT OF PRELIMINARY REPORT**

S. No.	Issues	Remarks
1	Recommendation of last protection checking and validation	Status of works & pending issues if any
2	Review of existing settings at substation	Recommended Action
3	Disturbance Recorder out/ available for last 6 trippings (Y/N)	Recommended Action
4	Chronic reason of tripping, if any	Recommended Action
5	Major non-conformity/deficiency observed	Recommended Action

c. The **relay configuration check-list** for available power system elements at station:

- Transmission Line
- Bus Reactor/Line Reactor
- Inter-connecting Transformer
- Busbar Protection Relay
- AC auxiliary system
- DC auxiliary system
- Communication system
- Circuit Breaker Details
- Current Transformer details
- Capacitive Voltage Transformers Details
- Any other equipment/system relevant for protection system operation

d. The **minimum set of points on which checking & validation** shall be carried out is covered in this clause. The detailed list shall be prepared by checking and validation team in consultation with concerned entity, RLDC and RPC.

**i. Transmission Line Distance Protection/Differential Protection;**

- Name and Length of Line
- Whether series compensated or not
- Mode of communication used (PLCC/OPGW)

- Relay Make and Model for Main-I and Main-II
- List of all active protections & settings
- Carrier aided scheme if any
- Status of Power Swing/Out of Step/SOTF/Breaker Failure/Broken Conductor/STUB/Fault Locator/DR/VT fuse fail/Overvoltage Protection/Trip Circuit supervision/Auto-reclose/Load encroachment etc.
- Relay connected to Trip Coil-1 or 2 or both i. CT ratio and PT ratio
- Feed from DC supply-1 or 2
- Connected to dedicated CT core (mention name)
- Other requirements for protection checking and validation

**ii. Shunt Reactor & Inter-connecting Transformer (ICT) Protection;**

- Whether two groups of protections used (Group A and Group B)
- Do the groups have separate DC sources
- Relay Make and Model
- List of all active protections along with settings
- Status of Differential Protection/Restricted Earth Fault Protection/Back-up Directional Overcurrent/Backup Earth fault/ Breaker Failure
- Status of Oil Temperature Indicator/Winding-Temperature Indicator/Bucholz/Pressure Release Device etc.
- Relay connected to Trip Coil-1 or 2 or both
- CT ratio and PT ratio
- Feed from DC supply-1 or 2
- Connected to dedicated CT core (mention name)
- Other requirements for protection checking and validation

**iii. Busbar Protection Relay;**

- Busbar and redundant relay make and model
- Type of Busbar arrangement
- Zones
- Dedicated CT core for each busbar protection (Yes/No)
- Breaker Failure relay included (Yes/No), if additional then furnish make and model
- Trip issued to both Busbar protection in case of enabling
- Isolator indication and check relays

- Other requirements for protection checking and validation

**iv. AC auxiliary system;**

- Source of AC auxiliary system
- Supply changeover between sources (Auto/Manual)
- Diesel generator (DG) details
- Maintenance plan and supply changeover periodicity in DG
- Single Line Diagram
- Other requirements for protection checking and validation

**v. DC auxiliary system;**

- Type of Batteries (Make, vintage, model)
- Status of battery Charger
- Measured voltage (positive to earth and negative to earth)
- Availability of ground fault detectors
- Protection relays and trip circuits with independent DC sources
- Other requirements for protection checking and validation
- Communication system
  - Mode of communication for Main-1 and Main-2 protection
  - Mode of communication for data and speech communication
  - Status of PLCC channels
  - Time synchronization equipment details
  - 7OPGW on geographically diversified paths for Main-1 and main-2 relay
  - Other requirements for protection checking and validation

**vi. Circuit Breaker Details;**

- Details and Status
- Healthiness of Tripping Coil and Trip circuit supervision relay
- Single Pole/Multi pole operation
- Pole Discrepancy Relay available (Y/N)
- Monitoring Devices for checking the dielectric medium
- Other requirements for protection checking and validation
- Current Transformer (CT)/Capacitive Voltage Transformer (CVT) Details
  - CT/CVT ID name and voltage level

- CT/CVT core connection details
- Accuracy Class
- Whether Protection/Metering
- CT/CVT ratio available and ratio adopted
- Details of last checking and validation of CT/CVT healthiness
- Other requirements for protection checking and validation
- Other protections: Direction earth fault, negative sequence, over current, over voltage, over frequency, under voltage, under frequency, forward power, reverse power, out of step/power swing, HVDC protection etc.

### 3. Summary of checking:

The summary shall specifically mention minimum following points:

- a) The settings and scheme adopted are in line with agreed protection philosophy or any accepted guidelines (e.g. Ramakrishna guidelines or CBIP manual based).
- b) The deviations from the RPC protection philosophy, if any and reasons for taking the deviations shall be recorded.
- c) All the major general deficiency shall be listed in detail along with remedial recommendations.
- d) The relay settings to be adopted shall be validated with simulation based or EMTP studies and details shall be enclosed in report.
- e) The cases of protection maloperation shall be analysed from protection indices report furnished by concerned utility, the causes of failure along with corrective actions and recommendations based on the findings shall be noted in the report.

## Annexure – 6: Protection Philosophy/Protocol of Northern Region

The Protection Philosophy/Protocol of Northern Region is developed in compliance of IEGC 2023, Version 2.0 which was approved in 71<sup>st</sup> NRPC meeting held on 29.01.2024.

S.N.	Protection Setting/Protocol	Mandated Setting for transmission lines
1	<b>Protection Scheme</b>	<p>220KV and above: Independent Main-I and Main-II protection (of different make OR different type/different algorithm) of non-switched numerical type is to be provided with carrier aided scheme.</p> <p>132KV and below: One non-switched distance protection scheme and, directional over current and earth fault relays, should be provided as back up.</p>
2	<b>Distance Protection Zone-1</b>	<p>Reach: 80% of the protected line; 110% of the protected line (In case of radial lines) Time Setting: Instantaneous.</p>
3	<b>Distance Protection Zone-2</b>	<p>Reach: Single Circuit Line: 120% of length of principle line section. Double circuit line: 150% coverage of line to take care of under reaching due to mutual coupling effect.</p> <p>Time setting: i. 0.35 second <i>(considering LBB time of 200mSec, CB open time of 60ms, resetting time of 30ms and safety margin of 60ms)</i> ii. 0.5-0.6 second <i>(For a long line followed by a short line)</i></p>

S.N.	Protection Setting/Protocol	Mandated Setting for transmission lines
4	<b>Distance Protection Zone-3</b>	Reach: Zone-3 should overreach the remote terminal of the longest adjacent line by an acceptable margin (typically 20% of highest impedance seen) for all fault conditions. Time Setting: 800-1000 msec If zone-3 reach transcends to other voltage level, time may be taken up to 1.5 sec.
5	<b>Distance Protection Zone- 4</b>	The Zone-4 reverse reach must adequately cover expected levels of apparent bus bar fault resistance. Time may be coordinated accordingly. Where Bus Bar protection is not available, time setting: 160 msec.
6	<b>Lines with Series and other compensations in the vicinity of Substation</b>	<ul style="list-style-type: none"> <li>• Zone-1:                FSC end: 60% of the protected line.                Time: Instantaneous;                Remoted end: 60% of the protected line with 100ms-time delay. POR Communication scheme logic is modified such that relay trips instantaneously in Zone-1 on carrier receive.</li> <li>• Zone-2:                120 % of uncompensated line impedance for single circuit line. For Double circuit line, settings may be decided on basis of dynamic study in view of zero sequence mutual coupling.</li> <li>• Phase locked voltage memory is used to cope with the voltage inversion. Alternatively, an intentional time delay may be applied to overcome directionality problems related to voltage inversion.</li> <li>• Over-voltage stage-I setting for series compensated double circuit lines may be kept</li> </ul>

S.N.	Protection Setting/Protocol	Mandated Setting for transmission lines
		higher at 113%.
7	<b>Power Swing Blocking</b>	<ul style="list-style-type: none"> <li>Block tripping in all zones, all lines.</li> </ul> Out of Step tripping to be applied on all inter-regional tie lines. Deblock time delay = 2s
8	<b>Protection for broken conductor</b>	Negative Sequence current to Positive Sequence current ratio more than 0.2 (i.e. $I_2/I_1 \geq 0.2$ ) Alarm Time delay: 3-20 sec. Tripping may be considered for radial lines to protect single phasing of transformers.
9	<b>Switch on to fault (SOTF)</b>	Switch on to fault (SOTF) function to be provided in distance relay to take care of line energization on fault.
10	<b>VT fuse fail detection function</b>	VT fuse fail detection function shall be correctly set to block the distance function operation on VT fuse failure.
11	<b>Carrier Protection</b>	To be applied on all 220KV and above lines with the only exception of radial feeders.
12	<b>Back up Protection</b>	1. On 220KV and above lines with 2 Main Protections: <ul style="list-style-type: none"> <li>Back up Earth Fault protections alone to be provided.</li> <li>No Over current protection to be applied.</li> </ul> 2. At 132KV and below lines with only one Main protection: <ul style="list-style-type: none"> <li>Back up protection by IDMT O/C and E/F to be applied.</li> </ul>

S.N.	Protection Setting/Protocol	Mandated Setting for transmission lines
13	<b>Auto Reclosing with dead time.</b>	<p>AR shall be enabled for 220KV and above lines for single pole trip and re-closing. Dead time = 1.0s. Reclaim time = 25.0s</p> <p>Auto-recloser shall be blocked for following:</p> <ul style="list-style-type: none"> <li>• Faults in cables</li> <li>• Breaker Fail Relay</li> <li>• Line Reactor Protections</li> <li>• O/V Protection</li> <li>• Received Direct Transfer trip signals</li> <li>• Busbar Protection</li> <li>• Zone 2/3 of Distance Protection</li> <li>• Circuit Breaker Problems.</li> </ul> <p>CB Pole discrepancy relay time:1.5 sec; for tie breaker: 2.5 sec</p>
14	<b>Busbar protection</b>	To be applied on all 220KV and above sub stations with the only exception of 220KV radial fed bus bars.
15	<b>Local Breaker Backup (LBB)</b>	<p>For 220KV and above level substations as well as generating stations switchyards, LBB shall be provided for each circuit breaker.</p> <p>LBB Current sensor I &gt; 20% In LBB time delay = 200ms</p> <p>In case of variation in CT ratio, setting may be done accordingly.</p>
16	<b>Line Differential</b>	<p>For cables and composite lines, line differential protection with built in distance back up shall be applied as Main-I protection and distance relay as Main-II protection.</p> <p>For very short line (less than 10 km), line differential protection with distance protection as</p>



S.N.	Protection Setting/Protocol	Mandated Setting for transmission lines
		<p>backup (built- in Main relay or standalone) shall be provided mandatorily as Main-I and Main-II.</p> <p>Differential protection may be done using dark fiber (preferably), or using bandwidth.</p>
17	<b>Over Voltage Protection</b>	<p>FOR 765KV LINES/CABLE:  Low set stage (Stage-I): 106% - 109% (typically 108%) with a time delay of 5 seconds.  High set stage (Stage-II): 140% - 150% with a time delay of 100 milliseconds.</p> <p>400KV LINES/CABLE:  Low set stage (Stage-I): 110% - 112% (typically 110%) with a time delay of 5 seconds.  High set stage (Stage-II): 140% - 150% with a time delay of 100 milliseconds.</p> <p>FOR 220KV LINES:  No over-voltage protection shall be used.</p> <p>FOR 220KV CABLE:  Low set stage (Stage-I): 110% - 112% (typically 110%) with a time delay of 5 seconds.  High set stage (Stage-II): 140% - 150% with a time delay of 100 milliseconds.</p> <p>Drop-off to pick-up ratio of overvoltage relay:  better than 97%</p> <p>Grading: Voltage as well as time grading may be</p>

S.N.	Protection Setting/Protocol	Mandated Setting for transmission lines
		done for multi circuit lines/cable.
18	<b>Resistive reach setting to prevent load point encroachment</b>	<p>Following criteria may be considered for deciding load point encroachment:</p> <ul style="list-style-type: none"> <li>• Maximum load current (Imax) may be considered as 1.5 times the thermal rating of the line or 1.5 times the associated bay equipment current rating (the minimum of the bay equipment individual rating) whichever is lower. (Caution: The rating considered is approximately 15minutes rating of the transmission facility).</li> <li>• Minimum voltage (V min) to be considered as 0.85pu (85%).</li> </ul>
19	<b>Direct Inter-trip</b>	<p>To be sent on operation of following:</p> <ol style="list-style-type: none"> <li>i. Overvoltage Protection</li> <li>ii. LBB Protection</li> <li>iii. Busbar Protection</li> <li>iv. Reactor Protection</li> <li>v. Manual Trip (400KV and above)</li> <li>vi. Cable Fault (in composite lines)</li> </ol>
20	<b>Permissive Inter-trip</b>	To be sent on operation of Distance Protection

## Annexure – 7: Work Order & Corrigendum



पावर ट्रांसमिशन कारपोरेशन ऑफ उत्तराखण्ड लि0  
(उत्तराखण्ड सरकार का उपक्रम)  
अधीक्षण अभियन्ता (परीक्षण एवं परिचालन एवं स्काडा) कार्यालय  
कुमायु मण्डल हल्द्वानी  
मोबाइल नं0 9412089275, ईमेल dp\_singh@ptcul.org

No. 376 /SE (T&C)/PTCUL/ (H)/

Date:29.09.2023

Subject:- Order for Protection Audit of 02 Nos 400 kV and 08 Nos 220KV sub-stations in PTCUL.

Joint Advisor

Central Board of Irrigation and Power

Malcha Marg Chanakyapuri,

New Delhi-110021

Email: mrchauhan@cbip.org.

Dear Sir,

In reference to your offer submitted vide Ref No: P-1/CBIP/PTCUL/PTCUL/Audit/2023 dated: 11.09.2023 through email against Email enquiry dated 05.09.2023, an order is hereby placed in favour of your firm for the work of "Protection Audit of 02 Nos 400kV and 08 Nos 220 kV substations of PTCUL" The detail of material, price schedule and terms & conditions is here as under:-

Sr.No	Description	Unit	Qty	Amount	Total Amount
1	Protection Audit to be carried out for the following 10 nos of the 400/220kV substations of PTCUL :- 1. 400kV S/s Rishikesh 2. 400 kV S/s Kashipur 3. 220kV S/s Chamba 4. 220kV S/s Rishikesh 5. 220kV S/s Roorkee 6. 220kV S/s Haridwar (SIDCUL) 7. 220kV S/s Jhajra. 8. 220 kV S/s Pantnagar. 9. 220 kV S/s Haldwani. 10. 220kV S/s Mahuakheraganj.	Job	1	36,25,000	36,25,000
TOTAL					36,25,000

Total value of order is Rs.36,25,000 (Rupees Thirty Six Lakh Twenty Five Thousand only ) Plus GST Extra.

End: 1. Terms & Conditions.

Please acknowledge the receipt and acceptance of order.

(D.P Singh)

Superintending Engineer (T&C), Haldwani

No.376 /SE (T&C)/PTCUL/ (H)/

Date:29.09.2023

Copy forwarded to the following for information and necessary action:-

1. Director (Operation), PTCUL, Dehradun.
2. Superintending Engineer (A) MD, PTCUL, Dehradun.
3. Chief Engineer, T&C PTCUL, 132kV Substation Campus, Kathgodam Nainital.
4. Executive Engineer, T&C Division, Kashipur.
5. Director (Energy), Central Board of Irrigation and Power Malcha Marg Chanakyapuri, New Delhi-110021 Email: [sanjeev@cbip.org](mailto:sanjeev@cbip.org)

(D.P Singh)

Superintending Engineer (T&C), Haldwani

मुख्यालय एवंपंजीकृत कार्यालय:-विद्युतमवन, नजदीक-आई0एस0बी0टी0 क्रासिंग, सहारनपुररोड, माजरा, देहरादून-248002  
कारपोरेटआईडी नं0: U40101UR2004GOI028675 दूरभाष नं0 0135-2646000 फॅक्स नं0 0135-2643460 वेबसाइट [www.ptcul.org](http://www.ptcul.org)



पावर ट्रांसमिशन कारपोरेशन ऑफ उत्तराखण्ड लि०  
(उत्तराखण्ड सरकार का उपक्रम)  
अधीक्षण अभियन्ता (परीक्षण एवं परिचालन एवं स्काडा) कार्यालय  
कुमायु मण्डल हल्द्वानी  
मोबाइल नं० 9412089275, ईमेल dp\_singh@ptcul.org

Terms & Conditions:-

1	Scope	<p>: The detailed Scope work is as under:</p> <ol style="list-style-type: none"><li>1. There must be a kick off meeting for discussion on project plan before start of the work in field and the detailed plan of performance shall be submitted by CBIP.</li><li>2. Requisite data shall be collected in standard format from PTCUL grid substations by authorized and experienced auditor.</li><li>3. The site surveys and audit of grid substations of PTCUL shall be done by authorized and experienced auditor.</li><li>4. Review of the implemented protection schemes/philosophy for 400/220 kV substations which includes protection of transmission lines,interconnecting transformers, line/busreactors, bus bar, bus couplers etc.as per latest guidelines of Ramakrishna committee/CBIP/NRPC/Intenational best practices.etc.</li><li>5. Review the adequacy of primary and backup protection settings for protected equipment and suggest corrective measures where evernon compliance with respect to Ramakrishna committee/ CBIP/NRPC is found during the protection audit.</li><li>6. Review of availability/healthiness of PLCC communication links used for protection systems.</li><li>7. Review the healthiness/adequacy of 220/110/50V DC system available at substations for protection application.</li><li>8. Review of availability/healthiness of GPS system and time synchronization facility used for protection.</li><li>9. Review of availability/healthiness of recording instruments like DRs /ELs for transmission lines protection.</li><li>10. Review of test reports for assessing the healthiness of circuit breakers, CT &amp; CVT based upon available test reports at sites.</li><li>11. Field inspection of protection device for obsolescence of technology, suitability and healthiness.</li><li>12. Directory of the protection system &amp; recommendation for replacement of obsolescence relays with compatible numerical relays will be provided.</li><li>13. Checking of availability of DGset/auxiliary DC supply at substations.</li><li>14. Site visits for onsite protection audit, review and inspection of substations will be performed.</li><li>15. Submission of the detailed report for the protection audit including the protection philosophy, reviewed settings and protection audit observations.</li><li>16. The performance of above protection equipment like relays, circuit breaker, CT, CVT, DC battery bank, synchro facility, communication facility used for protection will be also checked through physical inspection and provided test reports/documents. These protection equipments will be recommended for renovation and upgradation based on their performance accessed during protection audit and physical inspection.</li><li>17. Review the availability healthiness of<ul style="list-style-type: none"><li>• Event recorders/ loggers' operation history</li><li>• CT, CVT, CB</li><li>• DC power supply</li><li>• Auxiliary supply</li><li>• Communication links</li><li>• Time synchronization/ GPS</li></ul></li><li>18. Review of Testing and Maintenance records of all protective relays, Circuit Breakers CT, CVT etc. Review of protection philosophy.</li></ol>
---	-------	--

मुख्यालय एवंपंजीकृत कार्यालय:-विद्युतमवन, नजदीक-आई०एस०बी०टी० क्रासिंग, सहारनपुररोड, माजरा, देहरादून-248002  
कारपोरेटआईडी नं०: U40101UR2004GOI028675 दूरभाष नं० 0135-2646000 फ़ैक्स नं० 0135-2643460 वेबसाइटwww.ptcul.org





पावर ट्रांसमिशन कारपोरेशन ऑफ उत्तराखण्ड लि०  
(उत्तराखण्ड सरकार का उपक्रम)  
अधीक्षण अभियन्ता (परीक्षण एवं परिचालन एवं स्काडा) कार्यालय  
कुमायु मण्डल हल्द्वानी  
मोबाइल नं० 9412089275, ईमेल dp\_singh@ptcul.org

			19. Anything which is left to be mentioned here but required for successful completion of the aforementioned subject work shall be done <b>Central Board of Irrigation and Power Malcha Marg Chanakyapuri, New Delhi-110021</b> 20. CBIP Delhi shall submit a report on detailed points in four sets of hard copy duly spiraled binding as well as soft copy shall be submitted. 21. The safety guidelines prevalent in PTCUL must be followed.
2	GST	:	GST shall be paid extra as per applicable Government rules.
3	Tax	:	Tax shall be deducted at source as per applicable Government rules. A certificate to this effect may be given to the Contractor if required.
4	Date of Start of work	:	Order shall be considered as having come in to force from the date of issue of order.
5	Supply Completion	:	NA
6	Work completion	:	The work should be completed within 24 months from the date of issue of order.
7	Engineer of the contract		Superintending Engineer (T&C), Haldwani is the "Engineer of the contract" who shall be placing the order for the work with the contractor and signing the contract agreement and who has been inherently vested with such powers by corporation in this behalf and shall act as Engineer for the purpose of the contract.
8	Engineer in-charge		<b>Respective Executive Engineer (T&amp;C) shall be "Engineer in charge"</b> for the subject work.
9	Liquidity damages	:	if the contract is delayed beyond the stipulated period mentioned in the contract. The liquidity damages shall be levied @ 0.5 % per week and maximum up to 10% of contract value.
10	Dispute		All Dispute arising out of this case under the jurisdiction local court at Kashipur and Honable High Court, Nainital.
11	Payment terms	:	1. 25% Payment will be made within 30 days after finalization of Audit plan, subject to availability of funds from PTCUL HQ. 2. 35% Payment will be made within 30 days after submission of preliminary reports verified by Executive Engineer of respective division, subject to availability of funds from PTCUL HQ. 3. 40 % Payment will be made within 30 days after submission of final reports verified by Executive Engineer of respective division, subject to availability of funds from PTCUL HQ.
12	Payment unit		Test & Commissioning Division, Kashipur shall be the payment unit and all units where is to be work done shall record the measurement and duly passed bills along with measurement book shall be submitted to payment unit.
13	Warranty period	:	NA.
14	Billing Address	:	Executive Engineer Test & Commissioning Division, PTCUL 400 KV Substation Campus, Kashipur (Uttarakhand)-244713, GSTIN No. (05AAECM1785FC29)

All other term and condition of this order shall be governed by the General conditions of the contract prevalent in PTCUL.

(D.P Singh)

Superintending Engineer(T&C), Haldwani

मुख्यालय एवंपंजीकृत कार्यालय:-विद्युतमवन, नजदीक-आईएसबीटी क्रॉसिंग, सहारनपुररोड, माजरा, देहरादून-248002  
कारपोरेटआईडी नं०: U40101UR2004GOI028675 दूरभाष नं० 0135-2646000 फैक्स नं० 0135-2643460 वेबसाइट [www.ptcul.org](http://www.ptcul.org)



पावर ट्रान्समिशन कारपोरेशन ऑफ उत्तराखण्ड लि०  
(उत्तराखण्ड सरकार का उपक्रम)  
अधीक्षण अभियन्ता (परीक्षण एवं परिचालन एवं स्काडा) कार्यालय  
कुमायु मण्डल हल्द्वानी  
मोबाइल नं० 9412089275, ईमेल dp\_singh@ptcul.org

No. 394 /SE (T&C)/PTCUL/ (H)/

Date:26.10.2023

Subject:- Corrigendum for the Order for the work of Protection Audit of 02 Nos 400 kV and 08 Nos 220KV sub-stations in PTCUL

Joint Advisor

Central Board of Irrigation and Power

Malcha Marg Chanakyapuri,

New Delhi-110021

Email: mrchauhan@cbip.org.

Dear Sir,

In reference to above mentioned subject, please refer to kick off meeting held on dated 26.10.2023 for the work of Protection Audit of 02 Nos 400 kV and 08 Nos 220KV sub-stations in PTCUL against order no.376 dated 29.09.2023.

In this regard, kindly find enclosed herewith corrigendum of order no.376 dated 29.09.2023 (Annexure-1) with necessary amendments as discussed in aforementioned meeting.

This is for your kind information and necessary action.

Please acknowledge the receipt and acceptance of order.

(D.P Singh)

Superintending Engineer (T&C), Haldwani

Copy forwarded to the following for information and necessary action:-

1. Chief Engineer, T&C PTCUL, 132kV Substation Campus, Kathgodam Nainital..
2. Executive Engineer, T&C Division, Roorkee/Dehradun/Haldwani/Kashipur/Rishikesh with request to provide assistance and information to CBIP for the above work.
3. Director (Energy), Central Board of Irrigation and Power Malcha Marg Chanakyapuri, New Delhi-110021  
Email: [sanjeev@cbip.org](mailto:sanjeev@cbip.org)

मुख्यालय एवंपञ्जीकृत कार्यालय:-विद्युतमवन, नजदीक-आईएसबीटी क्रॉसिंग, सहारनपुररोड, माजरा, देहरादून-248002  
कारपोरेटआईडी नं०: U40101UR2004GOI028675 दूरभाष नं० 0135-2646000 फॅक्स नं० 0135-2643460 वेबसाइट-[www.ptcul.org](http://www.ptcul.org)

**Annexure -1 – Work order corrigendum**

Scope: The detailed Scope work is as under:

Sr. No.	Clause of PO	Existing Clause					Modified Clause						
		Sr. No.	Description	Unit	Qty	Amount	Total Amount	Sr. No.	Description	Unit	Qty	Unit rate (Rs.)	Total Amount (Rs.)
1	Price Schedule	1	Protection Audit to be carried out for the following 10 nos. of the 400/220KV substations of PTCUL:- 1. 400KV S/s Rishikesh 2. 400 KV S/s Kashipur 3. 220KV S/s Chamba 4. 220KV S/s Rishikesh 5. 220KV S/s Roorkee 6. 220KV S/s Haridwar (SIDCUL) 7. 220KV S/s Jhajra 8. 220 KV S/s Pantnagar 9. 220 KV S/s Haldwani 10. 220kv S/s Mahuaakheraganj. TOTAL	Job	1	36,25,000	36,25,000	1	Protection Audit to be carried out for the following 10 nos of the 400/220KV substations of PTCUL:- 1. 400KV S/s Rishikesh 2. 400 KV S/s Kashipur 3. 220KV S/s Chamba 4. 220KV S/s Rishikesh 5. 220KV S/s Roorkee 6. 220KV S/s Haridwar (SIDCUL) 7. 220KV S/s Jhajra 8. 220 KV S/s Pantnagar 9. 220 KV S/s Haldwani 10. 220KV S/s Mahuaakheraganj) TOTAL	Each	10	3,62,500	36,25,000
2	Terms and Conditions - 5. No. 1 – Scope	1	There must be a kick off meeting for discussion on project plan before start of the work in field and the detailed plan of performance shall be submitted by CBIP.					1	There must be a kick off meeting for discussion on project plan before start of the work in field and the detailed plan of performance shall be submitted by CBIP.				
		2	Requisite data shall be collected in standard format from PTCUL grid substations by authorized and experienced auditor.					2	Requisite data shall be collected in standard format from PTCUL grid substations by an experienced auditor.				
		3	The site surveys and audit of grid substations of PTCUL shall be done by authorized and experienced auditor.					3	The site surveys and audit of grid substations of PTCUL shall be done by an experienced auditor.				
		4	Review of the implemented protection schemes/ philosophy for 400/220 KV substations which includes protection of transmission lines, interconnecting transformers, line/bus reactors, bus bar, bus					4	Review of the implemented protection schemes/philosophy for 400/220 KV substations which includes protection of transmission lines, interconnecting transformers, line/bus reactors, bus bar, bus couplers etc. with respect to				









5. Clause of PO	Existing Clause	Modified Clause
No.	couplers etc as per latest guidelines of Ramakrishna committee/ CBIP/NRPC/international best practices, etc.	tripping in last one year as per latest guidelines of Ramakrishna committee/ CBIP/NRPC/international best practices, which includes review of the following:
5.	Review the adequacy of primary and backup protection settings for protected equipment and suggest corrective measures where everyone compliance with respect to Ramakrishna committee/ CBIP/NRPC is found during the protection audit.	a) Adequacy of primary and backup protection settings for protected equipment and suggest corrective measures
6.	Review of availability/healthiness of PLCC communication links used for protection systems.	b) Availability/healthiness of PLCC communication links used for protection systems.
7.	Review the healthiness/adequacy of 220/110/50V DC system available at substations for protection application.	c) Healthiness/adequacy of 220/110/50V DC system available at substations for protection application.
8.	Review of availability/healthiness of GPS system and time synchronization facility used for protection.	d) Availability/healthiness of GPS system and time synchronization facility used for protection.
9.	Review of availability/healthiness of recording instruments like DRs /ELs for transmission lines protection.	e) Availability/healthiness of recording instruments like DRs /ELs for transmission lines protection.
10.	Review of test reports for assessing the healthiness of circuit breakers, CT & CVT based upon available test reports at sites.	f) Test reports for assessing the healthiness of circuit breakers, CT & CVT based upon available test reports at sites.
11.	Field inspection of protection device for obsolescence of technology, suitability and healthiness.	g) Field inspection of protection device for obsolescence of technology, suitability and healthiness.
12.	Directory of the protection system & recommendation for replacement of obsolescence relays with compatible numerical relays will be provided.	h) Prepare recommendation for replacement of obsolescence relays with compatible numerical relays will be provided.
13.	Checking of availability of DG Set/auxiliary DC supply at substations.	i) Checking of availability of DG Set / auxiliary DC supply at substations.
14.	Site visits for onsite protection audit, review and inspection of substations will be performed.	5. Site visits for onsite protection audit, review and inspection of substations will be performed
15.	Submission of the detailed report for the protection audit including the protection philosophy, reviewed settings and protection audit observations.	6. Submission of the detailed report for the protection audit including the protection philosophy, reviewed settings and protection audit observations.
16.	The performance of above protection equipment like relays, circuit breaker, CT, CVT, DC battery bank, synchro facility, communication facility used for protection will be also checked through physical inspection and provided test reports/documents. These protection equipment's will be recommended for renovation and upgradation based on their performance accessed during protection audit and physical inspection.	Deleted as it is covered in point 4 above.







S. No.	Clause of PO	Existing Clause	Modified Clause
		<p>17. Review the availability healthiness of</p> <ul style="list-style-type: none"> <li>• Event recorders/ loggers' operation history</li> <li>• CT, CVT, CB</li> <li>• DC power supply</li> <li>• Auxiliary supply</li> <li>• Communication links</li> <li>• Time synchronization/ GPS</li> </ul> <p>18. Review of Testing and Maintenance records of all protective relays, Circuit Breakers CT, CVT etc. Review of protection philosophy.</p> <p>19. Anything which is left to be mentioned here but required for successful completion of the aforementioned subject work shall be done Central Board of Irrigation and Power Malcha Marg Chanakyapuri, New Delhi-110021</p> <p>20. CBIP Delhi shall submit a report on detailed points in four sets of hard copy duly spiraled binding as well as soft copy shall be submitted.</p> <p>21. The safety guidelines prevalent in PTCUL must be followed.</p>	<p>7. Anything which is left to be mentioned here but required for successful completion of the aforementioned subject work shall be done by Central Board of Irrigation and Power.</p> <p>8. CBIP Delhi shall submit a protection report on detailed points in four sets of hard copy duly spiraled binding and in soft copy as well.</p> <p>9. The safety guidelines prevalent in PTCUL must be followed.</p>
3	Terms and Conditions – S. No. 6 - Work Completion	The work should be completed within 24 months from the date of issue of order	The work should be completed within 24 weeks from the date of issue of corrigendum.
4	Terms and Conditions – S. No. 8 - Engineer-in-charge	Respective Executive Engineer (T&C) shall be "Engineer in charge" for the subject work.	<p>The following Executive Engineers (T&amp;C) shall be "Engineer in charge" for the subject work:</p> <p>a) 400KV Rishikesh, 220KV Rishikesh, 220 KV Chamba – Mr. Harsh Verma (Ph. No.9412074038 &amp; Email: ee_tandc_sh@ptcul.org).</p> <p>b) 400KV Kashipur, 220KV Pantnagar, 220KV Haldwani &amp; 220KV Mahuaaheraganj – Mr. Asim Baig (Ph. No. 9412087885 &amp; Email: ee_tandc_esp@ptcul.org).</p> <p>c) 220KV SIDCUL Haridwar, 220 KV Roorkee – Mr. Ashwini Kumar (Ph. No.7088117301 &amp; Email: ee_tandc_ake@ptcul.org).</p> <p>d) 220KV Jhaja – Mr. Ravindra Kumar (Ph. No. 9927744222 &amp; Email: ee_tandc_ddum@ptcul.org).</p>



4



S. No.	Clause of PO	Existing Clause	Modified Clause
5	<p>Terms and Conditions</p> <p>5. No. 11 - Payment Terms</p>	<p>1. 25% Payment will be made within 30 days after finalization of Audit plan, subject to availability of funds from PTCUL HQ.</p> <p>2. 35% Payment will be made within 30 days after submission of preliminary reports verified by Executive Engineer of respective division, subject to availability of funds from PTCUL HQ.</p> <p>3. 40 % Payment will be made within 30 days after submission of final reports verified by Executive Engineer of respective division, subject to availability of funds from PTCUL HQ.</p>	<p>1. 25% Payment will be made within 30 days after finalization of Audit plan, subject to availability of funds from PTCUL HQ.</p> <p>2. 35% Payment will be made within 30 days after submission of preliminary reports <b>on prorata basis</b> verified by Executive Engineer of respective division, subject to availability of funds from PTCUL HQ.</p> <p>3. 40 % Payment will be made within 30 days after submission of final reports <b>on prorata basis</b> verified by Executive Engineer of respective division, subject to availability of funds from PTCUL HQ.</p> <p>4. The local travel, lodging &amp; boarding shall be arranged by PTCUL on free-of-cost basis for CBIP team visiting the substation</p>







## **Annexure – 8: Data Sheets**

# Contents

<b>Single Line Diagrams</b> .....	80
<i>Substation Single Line Diagram</i> .....	80
<i>AC Auxiliary System</i> .....	81
<i>DC Auxiliary System</i> .....	82
<b>Transmission Lines</b> .....	84
<b>Bus-Bar Protection</b> .....	87
<b>AC Auxiliary System</b> .....	88
<b>DC Auxiliary System</b> .....	89
<b>Circuit Breakers</b> .....	90
<b>Current Transformer</b> .....	91
<b>Capacitive Voltage Transformer/Potential Transformer</b> .....	94
<b>Disturbance Recorder (DR) &amp; Event Logger (EL)</b> .....	95
<b>Communication System</b> .....	96
<b>Transformer Protection</b> .....	97
<b>Network Diagram of Uttarakhand</b> .....	100
<b>Power Map of Uttarakhand</b> .....	101

# Protection Audit of 220/33KV Roorkee Substation

## Annexure - 8

### Data Sheets

## Single Line Diagrams

### Substation Single Line Diagram

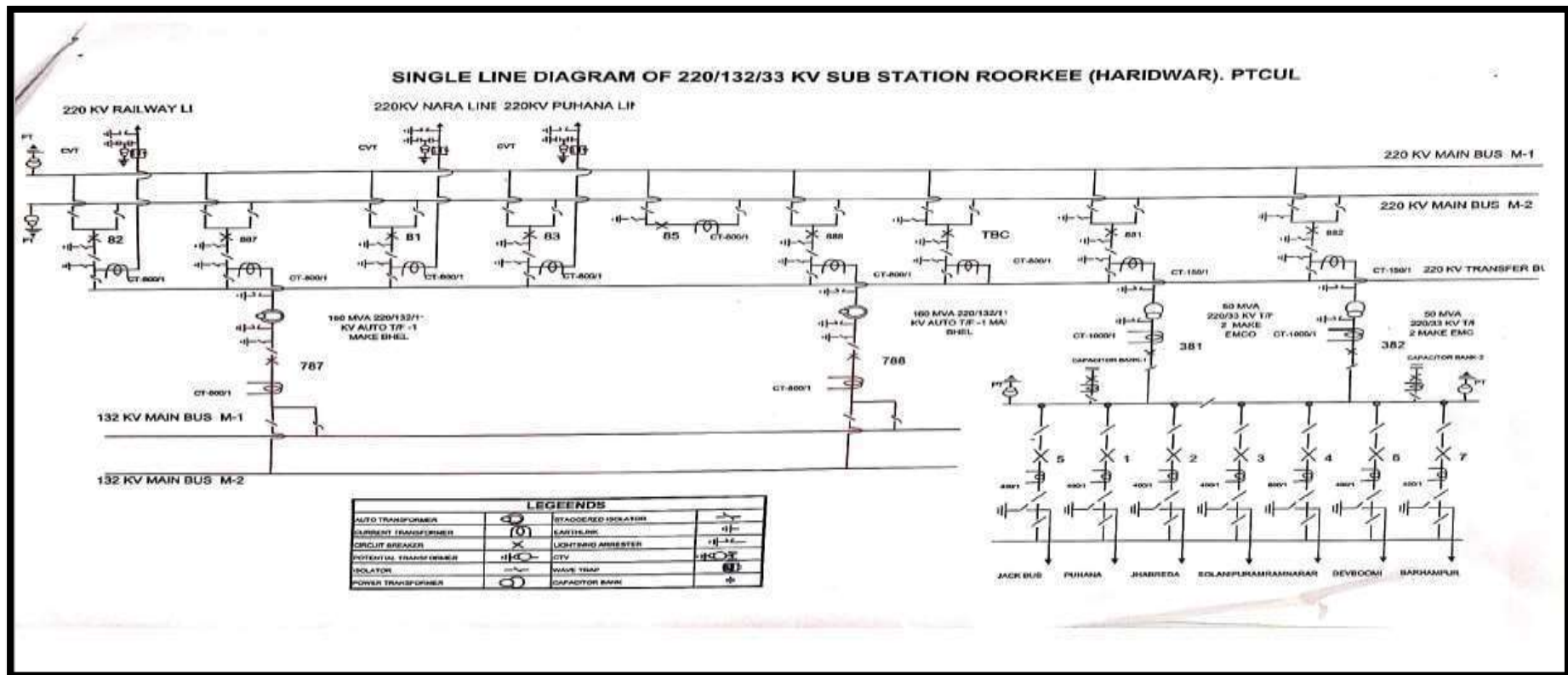

AC Auxiliary System

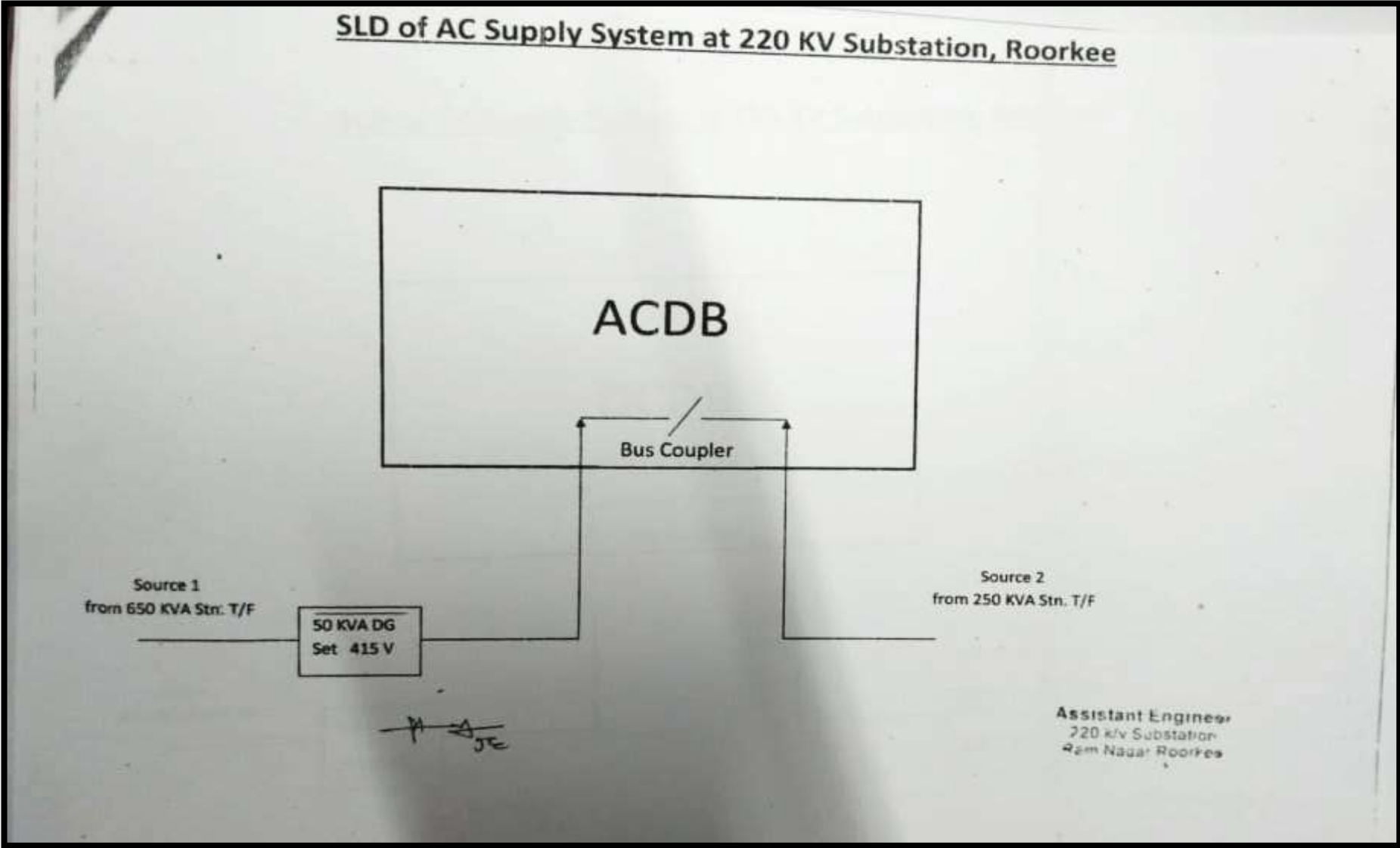

*DC Auxiliary System*

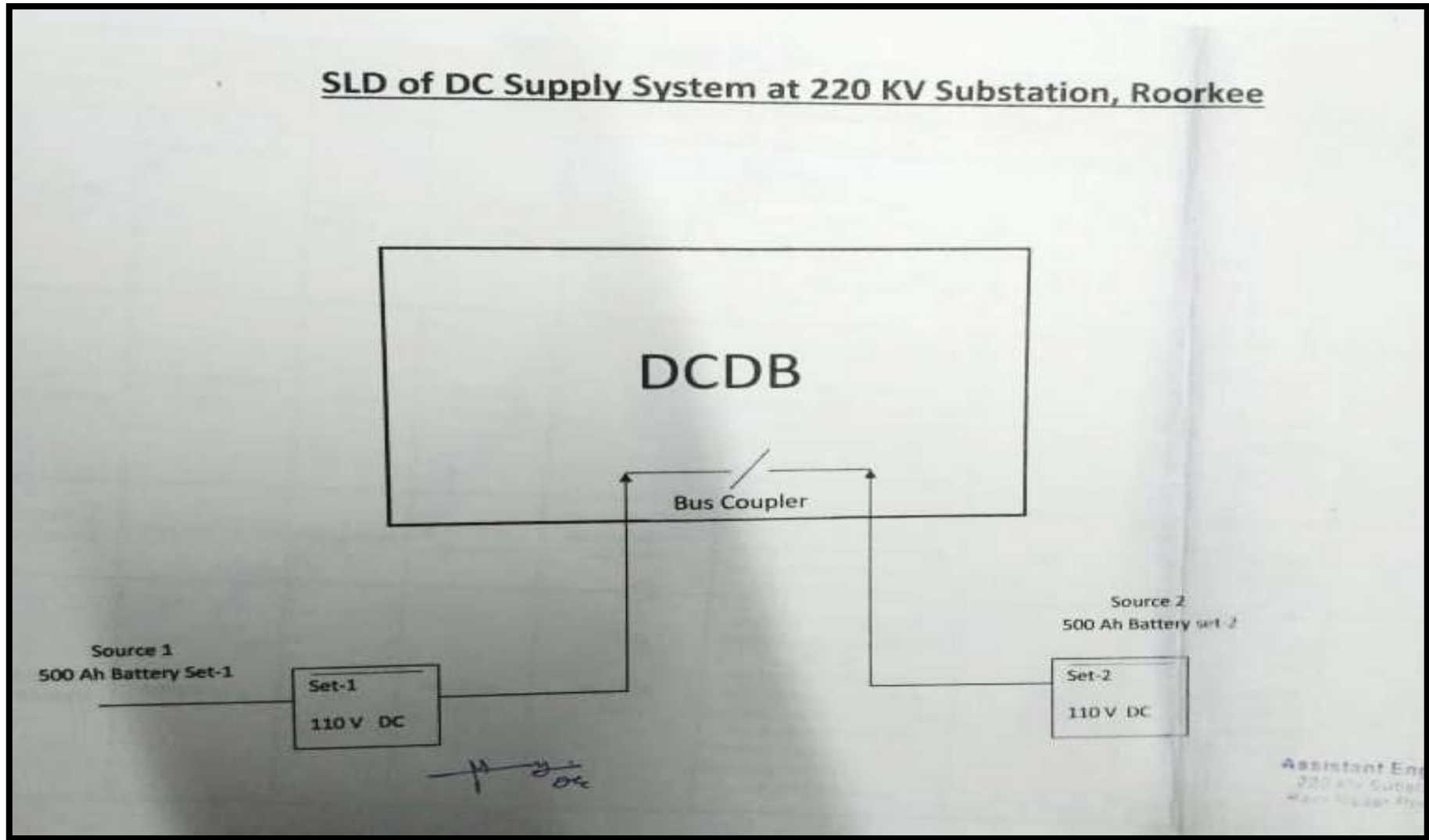



SAS Architecture diagram

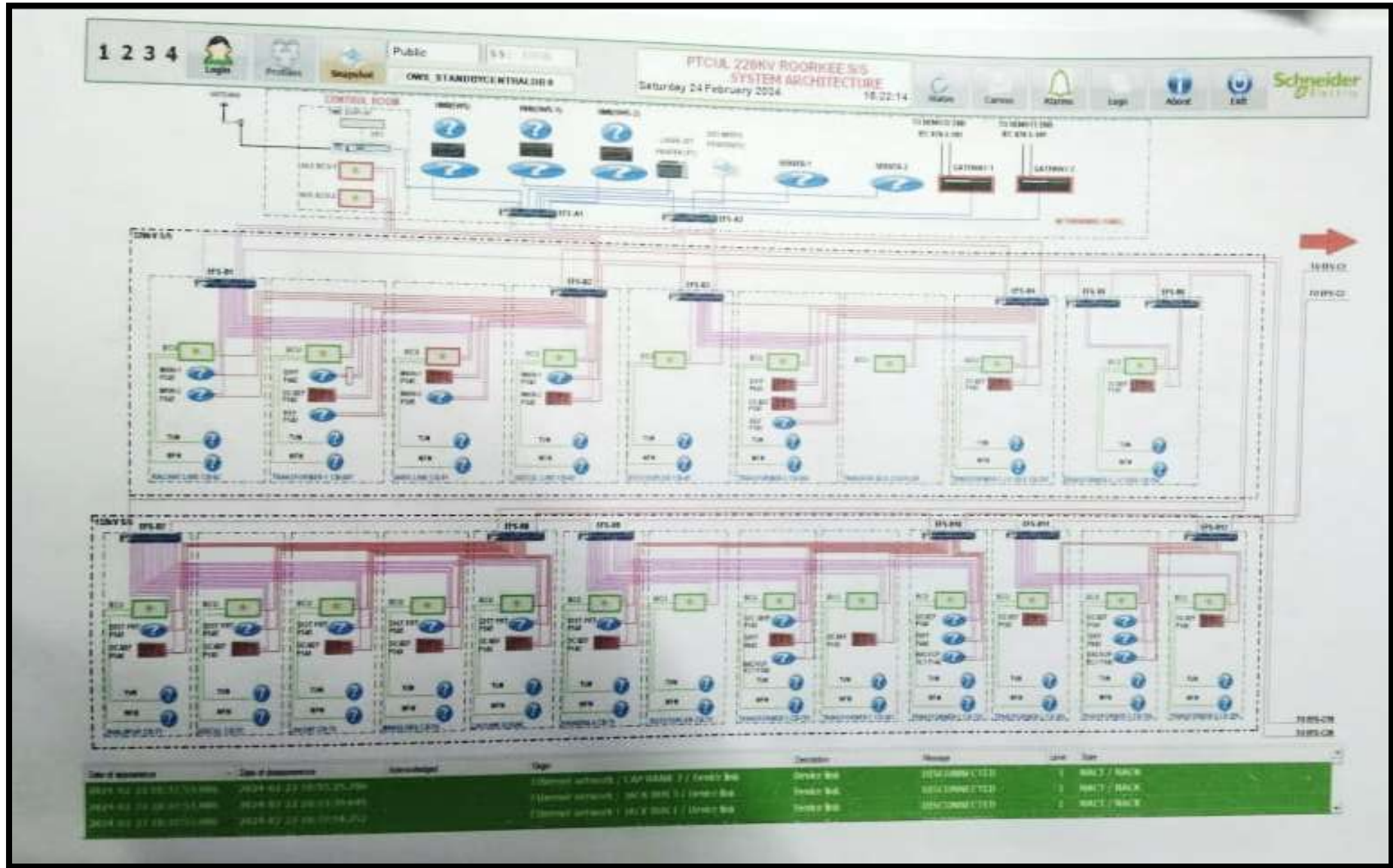



## Transmission Lines

220kV:

Particulars		Tr Line 1	Tr Line 2
Name of Tr Line		220 Imlikheda	220 Rishikesh
Length of Line		18.94	23.98
Series Compensated (Yes/No)		No	No
Connected to dedicated CT core (mention name)		Yes, PS	Yes, PS
CT Ratio		1600-800/1	1600-800/1
Connected to dedicated PT core (mention name)		Yes, 3P	Yes, 3P
PT Ratio		220KV/110V	220KV/110V
Relay connected to Trip Coil-1 or 2 or both		Both	Both
Feed from DC supply-1 or 2		1	1
i	Main-I Protection (Make and Model)	Schneider P545	Schneider P545
	Functional (Yes/No)	Yes	Yes
	Date of testing		
ii	Main-II Protection (Make and Model)	NA	NA
	Functional (Yes/No)	NA	NA
	Date of testing	NA	NA

Particulars		Tr Line 1	Tr Line 2
iii	LBB Protection (Make and Model)	NA	NA
	Functional (Yes/No)	NA	NA
	Date of testing	NA	NA
iv	PLCC/ Protection coupler (Make and Model)	NA	NA
	Functional (Yes/No)	NA	NA
v	DR (Make &Model) (Make and Model)	NA	NA
	Functional (Yes/No)	NA	NA
iv	Time Synch.Unit (Make and Model)	NA	NA
	Functional (Yes/No)	NA	NA
1	Status of Power Swing	Block in Zone 1	Block in Zone 1
2	Out of Step	NA	NA
3	SOTF	NA	NA
4	Breaker Failure	Yes	Yes
5	Broken Conductor	No	No
6	STUB	No	No
7	Fault Locator	Yes	Yes
8	Disturbance Recorder	Yes	Yes
9	VT fuse fail	Yes	Yes
10	Overvoltage Protection	No	No
11	Trip Circuit supervision	Yes	Yes

<b>Particulars</b>		<b>Tr Line 1</b>	<b>Tr Line 2</b>
12	Auto-reclose	Yes	Yes
13	Load encroachment	No	No

## Bus-Bar Protection

220kV

Sl. No.	Particulars	Observations
a	Busbar and redundant relay make and model	Electromechanical bus bar protection
b	Type of Busbar arrangement	Main 1-2 & Transfer
c	Zones	Three
d	Dedicated CT core for each busbar protection	Yes
e	Breaker Failure relay included, if additional then furnish make and model	NA
f	Trip issued to both Busbar protection in case of enabling	NA
g	Isolator indication and check relays	NA
h	Other requirements for protection checking and validation	NA

## AC Auxiliary System

Sl. No.	Particulars	Observations
a	Source of AC auxiliary system	01 No. 630 kVA 33/0.4 kV
b	Supply changeover between sources (Auto/Manual)	Auto
c	Diesel generator (DG) details	50 KVA
d	Maintenance plan and supply changeover periodicity in DG	NA
e	Single Line Diagram	NA
f	Other requirements for protection checking and validation	NA

## DC Auxiliary System

Sl. No.	Particulars	Observations			
		220 V DC - I	220 V DC - II	48 V DC-I	48 V DC-II
a	Make				
b	Model/Rating				
c	Vintage	3 Year	9 Year	6 Year	18 Year
d	Measured voltage				
	i. Positive to Earth	199 V	199 V	0 V	
	ii. Negative to Earth	42 V	42 V	47 V	
e	No. of Cells Per Bank	110	110	24	24
f	Availability of Battery Charger	Yes	Yes	Yes	yes

## Circuit Breakers

	Particulars	Make and Model	No. of trip/close coil	Trip Coil Supervision relay and healthiness of coils	LBB Setting Stage 1	LBB Setting Stage 2	Remarks (If any)
A	<b>220kV System</b>						
1	220 kV SIDCUL-RKSH	CGL, type-200-SFM-40S	6/3	Healthy	NA	NA	NA
2	220kV SIDCUL-PIRANKALIYAR	CGL, type-200-SFM-50AA	6/3	Healthy	NA	NA	NA
3	160 MVA ICT-1	CGL, type-200-SFM-50AA	6/3	Healthy	NA	NA	NA
4	160 MVA ICT-2	CGL, type-200-SFM-50AA	6/3	Healthy	NA	NA	NA
5	50 MVA	ABB, LTB245E1, 40KA	6/3	Healthy	NA	NA	NA
6	25 MVA	CGL, type-200-SFM-50AA	6/3	Healthy	NA	NA	NA

## Current Transformer

a	<b>Location of CT</b>	<b>220 KV SIDCUL-RKSH</b>				
b	Date of CT ratio Test Testing					
		Core I	Core II	Core III	Core IV	Core V
c	Accuracy Class	PS	PS	0.2	PS	PS
d	Purpose	MAIN	Back up	Metering	Protection	Protection
e	Test Results					
i	Ratio Adopted	1600-800/1	1600-800/1	1600-800/1	1600-800/1	1600-800/1
ii	Ratio measured	NA	NA	NA	NA	NA

a	<b>Location of CT</b>	<b>220 KV SIDCUL-PIRANKALIYAR</b>				
b	Date of CT ratio Test Testing					
		Core I	Core II	Core III	Core IV	Core V
c	Accuracy Class	PS	PS	0.2	PS	PS
d	Purpose	MAIN	Back up	Metering	Protection	Protection
e	Test Results					
i	Ratio Adopted	1600-800/1	1600-800/1	1600-800/1	1600-800/1	1600-800/1
ii	Ratio measured	NA	NA	NA	NA	NA



a	<b>Location of CT</b>	<b>160 MVA-I</b>				
b	Date of CT ratio Test Testing					
		Core I	Core II	Core III	Core IV	Core V
c	Accuracy Class	PS	PS	0.2	PS	PS
d	Purpose	MAIN	Back up	Metering	Protection	Protection
e	Test Results					
I	Ratio Adopted	1600-400/1	1600-400/1	1600-400/1	1600-400/1	1600-400/1
ii	Ratio measured	NA	NA	NA	NA	NA

a	<b>Location of CT</b>	<b>160 MVA-II</b>				
b	Date of CT ratio Test Testing					
		Core I	Core II	Core III	Core IV	Core V
c	Accuracy Class	PS	PS	0.2	PS	PS
d	Purpose	MAIN	Back up	Metering	Protection	Protection
e	Test Results					
I	Ratio Adopted	1600-400/1	1600-400/1	1600-400/1	1600-400/1	1600-400/1
ii	Ratio measured	NA	NA	NA	NA	NA

a	<b>Location of CT</b>	<b>50 MVA</b>				
b	Date of CT ratio Test Testing					
		Core I	Core II	Core III	Core IV	Core V
c	Accuracy Class	PS	PS	0.2	PS	PS
d	Purpose	MAIN	Back up	Metering	Protection	Protection
e	Test Results					
I	Ratio Adopted	1600-300/1	1600-300/1	1600-300/1	1600-300/1	1600-300/1
ii	Ratio measured	NA	NA	NA	NA	NA

a	<b>Location of CT</b>	<b>25 MVA</b>				
b	Date of CT ratio Test Testing					
		Core I	Core II	Core III	Core IV	Core V
c	Accuracy Class	PS	PS	0.2	PS	PS
d	Purpose	MAIN	Back up	Metering	Protection	Protection
e	Test Results					
I	Ratio Adopted	150-75/1	150-75/1	150-75/1	150-75/1	150-75/1
ii	Ratio measured	NA	NA	NA	NA	NA

## Capacitive Voltage Transformer/Potential Transformer

a	Location of CVT/PT	220 kV SIDCUL-RKSH		
b	Date of CT/PT ratio Test Testing			
		Core I	Core II	Core III
c	Accuracy Class	3P	3P	0.2
d	Purpose	Main	Backup	Metering
e	Test Results			
I	Ratio Adopted	220 kV/110 V	220 kV/110 V	220 kV/110 V
ii	Ratio measured	NA	NA	NA

a	Location of CVT/PT	220 kV SIDCUL-PIRANKALIYAR		
b	Date of CT/PT ratio Test Testing			
		Core I	Core II	Core III
c	Accuracy Class	3P	3P	0.2
d	Purpose	Main	Backup	Metering
e	Test Results			
I	Ratio Adopted	220 kV/110 V	220 kV/110 V	220 kV/110 V
ii	Ratio measured	NA	NA	NA

## Disturbance Recorder (DR) & Event Logger (EL)

Sl. No.	Particulars	220kV	132kV
1	a) Is the Disturbance recorder and Fault locator provided on all line feeders?	Yes	Yes
	b) Whether standalone or built in Main relay	Built in	Built in
	c) Whether DR is having automatic fault record download facility to a central PC	No	No
	d) Whether Central PC for DR, EL are powered by Inverter (fed from station DC)	Yes	Yes
2	Whether substation is having Event logger facility	Yes	Yes
	If Yes (standalone or built-in-SAS)	Built in	Built in
3	Whether GPS based time synchronizing equipment is provided at the substation for time synchronizing of Main relays / DR/ Event logger / SAS/ PMU / Line Current Differential Relays	Yes	

# Communication System

**Not Available**

## Transformer Protection

Particulars	TF-1	TF-2	TF-3	TF-4
Name of ICT	160 MVA I	160 MVA II	50 MVA	25 MVA
Make	IMP	IMP		
Connected to dedicated CT core (HV Bay)				
Core-1	Protection	Protection	Protection	Protection
Core-2	Protection	Protection	Protection	Protection
Core-3	Metering	Metering	Metering	Metering
Core-4	Protection	Protection	Not in use	Not in use
Core-5	Protection	Protection	Not in use	Not in use
CT ratio	1600-400/1	1600-400/1	1600-300/1	150-75/1
Connected to dedicated Bus CVT core (HV Bay)				
Core-1	Protection	Protection	Protection	Protection
Core-2	Protection	Protection	Protection	Protection
Core-3	Metering	Metering	Metering	Metering
CVT ratio	220 KV/110V	220 KV/110V	220 KV/110V	220 KV/110V
Relay connected to Trip Coil-1 or 2 or both (HV)	Both	Both	Both	Both
Feed from DC supply-1 or 2(LV)	Both	Both	Both	Both
Connected to dedicated CT core (LV Bay)				

Particulars		TF-1	TF-2	TF-3	TF-4
Core-1		Protection	Protection	Protection	Protection
Core-2		Protection	Protection	Protection	Protection
Core-3		Metering	Metering	Metering	Metering
Core-4		Protection	Protection	NA	NA
Core-5		Protection	Protection	NA	NA
CT ratio		1000-500/1 800-400/1	1000-500/1 800-400/1	1000-500/1	1000-500/1
Connected to dedicated Bus CVT core (LV Bay)					
Core-1		Protection	Protection	Protection	Protection
Core-2		Protection	Protection	Protection	Protection
Core-3		Metering	Metering	Metering	Metering
CVT ratio		132KV/110V	132KV/110V	33KV/110V	33KV/110V
Relay connected to Trip Coil-1 or 2 or both (HV)		Both	Both	Both	Both
Feed from DC supply-1 or 2(LV)		2	2	2	2
LA Rating/ HV Side		NA	NA	NA	NA
LA Rating/ LV Side		NA	NA	NA	NA
Date of last testing of Protection		NA	NA	NA	NA
Group A Protection					
1	Differential Protection (Make & Model)	ALSTOM P633	Schneider P643	GE T60	Schneider P643
2	PRV	YES	YES	YES	YES

Particulars		TF-1	TF-2	TF-3	TF-4
3	WTI Indication working	YES	YES	YES	YES
4	Back-up Over Current Protection HV (Make & Model)	P127	P127	F650	F650
5	Over Flux Protection (Make & Model) HV	NA	NA	NA	NA
Group B Protection					
1	REF Protection (Make & Model)	NA	NA	ALSTOM CAG14	ALSTOM P14NB
2	Bucholtz	YES	YES	YES	YES
3	Back-up Over Current Protection LV (Make & Model)	P127	P127	F650	F650
4	Over Flux Protection (Make & Model) LV	NA	NA	NA	NA
5	OTI Indication working	YES	YES	YES	YES



# Network Diagram of Uttarakhand

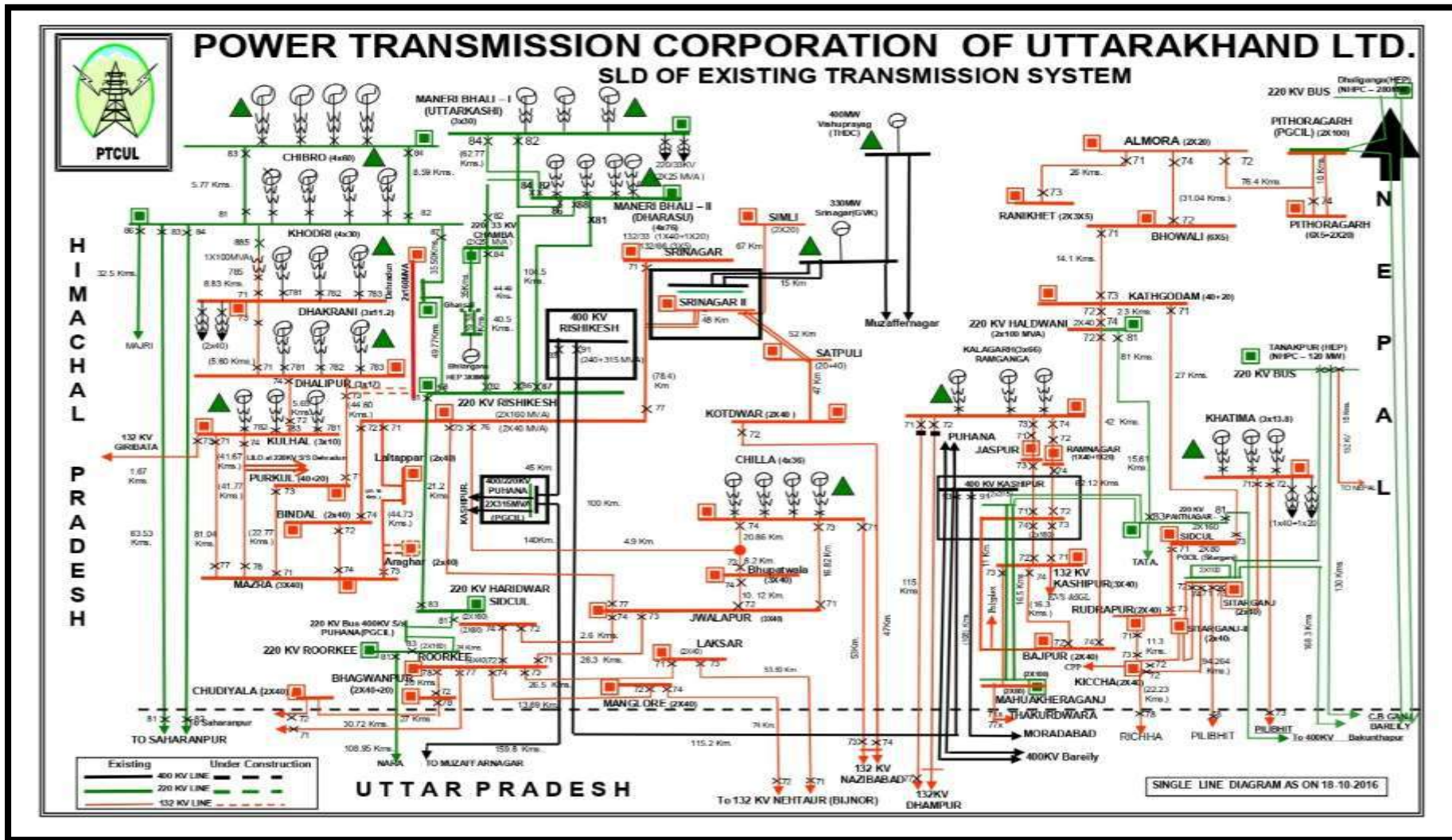

## Power Map of Uttarakhand





# **Power Transmission Corporation of Uttarakhand Limited**

(A Govt. of Uttarakhand Undertaking)

Corporate ID No.: U40101UR2004SGC028675

## **FINAL REPORT**

### **Protection Audit**

**220/132KV Jhajhra Substation**

**Submitted**

**By**



**CENTRAL BOARD OF IRRIGATION & POWER**

**NEW DELHI**





# केन्द्रीय सिंचाई व शक्ति मंडल CENTRAL BOARD OF IRRIGATION AND POWER

25<sup>th</sup> June 2024

Order No.: 376/SE (T&C)/PTCUL/(H). dated: 29.09.2023

## Protection Audit Report

FINAL PROTECTION AUDIT REPORT OF 220/132KV JHAJHRA SUB-STATION UNDER POWER TRANSMISSION  
CORPORATION OF UTTARAKHAND LIMITED (PTCUL), UTTARAKHAND.

Submitted  
To



**Power Transmission Corporation of Uttarakhand Limited**  
(A Govt. of Uttarakhand Undertaking)  
Corporate ID No.: U40101UR2004SGC028675

# Contents

<b>Disclaimer</b> .....	6
<b>1.0. Executive Summary</b> .....	7
<b>2.0. Introduction</b> .....	10
2.1. <i>Background</i> .....	10
2.2. <i>Scope of Work</i> .....	10
2.3. <i>Audit Rationale</i> .....	11
2.4. <i>Audit Process</i> .....	12
2.5. <i>About Power Transmission Corporation of Uttarakhand (PTCUL)</i> .....	14
2.6. <i>About Central Board of Irrigation &amp; Power (CBIP)</i> .....	15
<b>3.0. Preliminary Audit of 220/132KV Jhajhra Substation</b> .....	16
3.1. <i>General Information about Substation</i> .....	16
3.2. <i>Audit Team</i> .....	16
3.3. <i>Recommendation of last protection checking and validation</i> .....	17
3.4. <i>Review of existing settings at substation</i> .....	17
3.5. <i>Disturbance Recorder availability for the last 6 tripping's</i> .....	17
3.6. <i>Chronic reason of tripping, if any</i> .....	17
3.7. <i>Major non-conformity/deficiency observed</i> .....	18
<b>4.0. Tripping Statements</b> .....	19
<b>5.0. Observations and Recommendations</b> .....	43
5.1. <i>Reporting of all the Tripping with DR/EL</i> .....	43
5.2. <i>Development of centralized database of relay settings</i> .....	43
5.3. <i>Review of test results of relay and equipment</i> .....	44
5.4. <i>Availability of Testing Kits</i> .....	44
5.5. <i>Up-dation of PTCUL Protection Philosophy</i> .....	44
5.6. <i>Simulation based study of protection system</i> .....	45
5.7. <i>Capacity Building of protection team</i> .....	45
5.8. <i>Updated Fault Level/ Short Circuit Level and Network information</i> .....	45
5.9. <i>General Protection related observations</i> .....	45
5.10. <i>O&amp;M Manual</i> .....	45
<b>6.0. Station Specific Observation and Recommendations</b> .....	46
6.1. <i>Protection related observations and recommendations</i> .....	46
6.2. <i>Equipment related observations and recommendations</i> .....	47
6.3. <i>Auxiliary Equipment related observations and recommendations</i> .....	47
<b>Annexure – 1: Suggested List of Testing Instruments</b> .....	48
<b>Annexure – 2: Suggested List of Substation Equipments</b> .....	49
<b>Annexure – 3: Suggested List of Maintenance Equipments</b> .....	51

**Annexure – 4: Protection Code (IEGC 2023 Chapter 4)..... 52**

**Annexure – 5: Third Party Protection System Checking & Validation Template for a Substation (IEGC 2023 Annexure – 1)..... 58**

**Annexure – 6: Protection Philosophy/Protocol of Northern Region ..... 63**

**Annexure – 7: Work Order & Corrigendum ..... 69**

**Annexure – 8: Data Sheets..... 77**

## ACRONYMS

<b>A</b>	Ampere
<b>AC</b>	Alternating Current
<b>AMP</b>	Annual Maintenance Plan
<b>CBIP</b>	Central Board of Irrigation and Power
<b>CT</b>	Current Transformer
<b>CVT</b>	Capacitive Voltage Transformer
<b>DC</b>	Direct Current
<b>DG</b>	Diesel Generator
<b>DPR</b>	Detailed Project Report
<b>DR</b>	Disturbance Recorder
<b>EL</b>	Event Logger
<b>EMTP</b>	Electromagnetic Transient Program
<b>EE</b>	Executive Engineer
<b>GPS</b>	Global Positioning System
<b>ICT</b>	Inter Connecting Transformer
<b>IEGC</b>	Indian Electricity Grid Code
<b>JE</b>	Junior Engineer
<b>KA</b>	Kilo Ampere
<b>KV</b>	Kilo Volt
<b>LBB</b>	Local Breaker Backup
<b>LEFT</b>	Earth Fault
<b>MVA</b>	Mega Volt Ampere
<b>NA</b>	Not Available
<b>NRPC</b>	Northern Regional Power Committee
<b>O&amp;M</b>	Operation & Maintenance

<b>OCC</b>	Operation Coordination Sub Committee
<b>PLCC</b>	Power Line Carrier Communication
<b>PSC</b>	Power System Sub Committee
<b>PSDF</b>	Power System Development Fund
<b>PT</b>	Potential Transformer
<b>PTCUL</b>	Power Transmission Corporation of Uttarakhand Limited.
<b>RLDC</b>	Regional Load Dispatch Centre
<b>RPC</b>	Regional Power Committee
<b>SAS</b>	Substation Automation System
<b>SE</b>	Superintendent Engineer
<b>SCADA</b>	Supervisory Control & Data Acquisition
<b>SLD</b>	Single Line Diagram
<b>SLDC</b>	State Load Dispatch Centre
<b>SOTF</b>	Switch On-To Fault
<b>SPS</b>	Special Protection Scheme
<b>T&amp;C</b>	Testing & Commissioning
<b>UJVNL</b>	Uttarakhand Jal Vidyut Nigam Ltd
<b>UPCL</b>	Uttarakhand Power Corporation Ltd
<b>WTI</b>	Winding Temperature Indicator



## Disclaimer

The protection audit has been carried out based on the guidelines provided under various documents mentioned in the report. For the purpose of audit, the auditor(s) have relied upon the data made available by the client and information & clarifications made available, in the written or verbal form, by the officials of clients during site visit and later.

The report is not for public distribution and has been furnished solely for information and must not be reproduced or redistributed to others, except those concerned. No one can use the report as a base for any claim, demand or cause of action and, also no one is responsible for any loss incurred based upon the content of this report.

While every effort is made to ensure the accuracy and completeness of information contained, CBIP takes no responsibility and assumes no liability for any error/ omission or accuracy of the information. Recipients of this material should rely on their own judgments and conclusions from relevant sources before taking any decision.

## 1.0. Executive Summary

PTCUL awarded the work of Third-Party Protection Audit of 2 nos. 400kV and 8 nos. 220kV substations of PTCUL (“Utility”) to CBIP. CBIP planned the audit as per Audit process provided under Protection Code within Indian Electricity Grid Code 2023. In addition, the guidelines of Ramakrishna Committee for checking and validation and NRPC guidelines for Third Party Audit were also adhered too. The CBIP manual on protection (manual no 247-Revised), NRPC protection philosophy were also referred too.

As a part of audit process, utility was asked to provide set of information before start of audit. Team from CBIP consisting of Mr. Vijay Barthwal, Mr. M.R. Chauhan & Mr. Rounak Sen visited 220/132KV Jhajhra Substation during 29<sup>th</sup> February – 1<sup>st</sup> March 2024 and preliminary audit report was submitted on the spot. The representatives of utility were present during this process. Some more information was sought from the Utility.

Based on the data made available by Utility, draft of final report was submitted to Utility and after discussions, report was finalized. The details of audit process, data made available by Utility, observations from preliminary report and detailed observations and recommendations are provided in this report. Key observations and recommendations are summarized below under 2 heads.

### **General Observations and Recommendations for Organization Level implementation**

01. It is recommended that each substation to have a central repository for tripping reports, along with Time Synchronized DR/EL reports and analysis. A dedicated PC can be provided at each substation for the purpose.
02. The protection philosophy adopted by Utility, in general, is in alignment with protection philosophy adopted by NRPC. As the NRPC has recently updated the protection philosophy, PTCUL in consultation with SLDC may update protection philosophy for network not covered by NRPC too, if needed, and implement the same.
03. It is recommended that latest recommended relay settings, as per the NRPC protocol for 220KV & above Substations, along with setting calculations & parameters used for all the relays, be kept at each substation. This will help in proper fault analysis and ascertaining relay healthiness. Similarly, Relay settings for sub-stations below 220kV, based on any such protocol by SLDC, along with setting calculations and line parameters also needs to be maintained.
04. It is recommended that the detailed reports of test results for the relays and switchyard equipments be maintained at sub-station level.

05. Based on “Draft O&M Manual” of PTCUL and discussions with their officials, a list of testing equipment is suggested and enclosed at Annexure - 1. Also, a list of switchyard maintenance equipment is placed at annexure -3. It is recommended that the necessary testing and maintenance equipment at substation/Sub-division/Division be arranged for regular testing and maintenance of equipment at substations.
06. Simulation based studies or EMTP Studies should be carried out by the Utility, as per the requirement of IEGC-2023.
07. For the protection system and SAS, PTCUL may undertake capacity building exercise for the officials involved in these activities.
08. It is recommended that the updated network information and short circuit level should be periodically reviewed and maintained at central level for revising the setting as per requirement.
09. It is suggested that utility may carry out exhaustive safety and technical audit of sub-stations apart from protection audit, either internally or thru’ third party for implementing the best practices in the sub-station.
10. It is suggested that the existing draft O&M manual be updated to take care of latest developments.

#### **Observations and Recommendations for 220/132KV Jhajhra Substation:**

01. Among all the 10 nos. 220KV and above sub-stations of PTCUL, record keeping at Jhajhra sub-station is best.
02. After a major breakdown at 33KV level on 19.07.2023, a committee of PGCIL had visited substation. The suggestion/ recommendation of committee needs to be complied with.
03. Bus Bar Protection on 220kV Bus is commissioned, but due to non-availability of shut-down, stability test could not be carried out. It is recommended to get it commissioned at the earliest.
04. Multiple tripping at remote end due to over voltage at Vyasi generating plant and Zone -2 at Khodri Power House were observed. The remote end is a generating station; therefore, it is recommended that necessary protection co-ordination, based on latest NRPC guidelines be carried out with the generating company.
05. Due to fault on 33KV Network, LV side of transformers tripped in multiple instances. It is recommended that Protection co-ordination with distribution company to be carried out.
06. PLCC aided protection is not functional on important transmission lines. It is recommended to be taken up on priority for 220kV Khodri Line.

07. The sub-station is designed for single source DC, but fed using 2 sources using automatic changeover switches to maintain redundancy. It is suggested to carryout comprehensive review of DC distribution system and its philosophy.
08. Second station transformer connected to 33kV bus needs to be commissioned immediately for maintaining auxiliary supply.

## 2.0. Introduction

### 2.1. Background

The work has been awarded to the Central Board of Irrigation & Power (CBIP) vide Work Order Number: 376/SE (T&C)/PTCUL/(H), dated: 29.09.2023 for Protection Audit of 02 Nos. 400 kV and 08 Nos. 220 kV Sub-Station at Uttarakhand, for Power Transmission Corporation of Uttarakhand Limited (PTCUL) in reference to the offer submitted by CBIP to PTCUL vide ref. no. P-1/CBIP/PTCUL/Audit/2023, dated: 11.09.2023. A Kick-Off Meeting was held between PTCUL and CBIP at the office of SE (T&C), PTCUL, Kathgodam, Haldwani on 26<sup>th</sup> October 2023. Detailed discussions were held regarding process and methodology of Execution and Submission of reports of Protection Audit. As per the above-mentioned meeting, a corrigendum was released by PTCUL vide ref. no. 394/SE (T&C)/PTCUL/(H), dated: 26.10.2023.

**As per the given order, the protection audit of following sub-stations is to be carried out**

1. *400kV Rishikesh*
2. *400kV Kashipur*
3. *220kV Chamba*
4. *220kV Rishikesh*
5. *220kV Roorkee*
6. *220kV Haridwar (SIDCUL)*
7. *220kV Jhajra*
8. *220kV Pantnagar*
9. *220kV Haldwani*
10. *220kV Mahuakheraganj*

### 2.2. Scope of Work

Review of the implemented protection schemes/philosophy for 400/220 kV substations which includes protection of transmission lines, interconnecting transformers, line/bus reactors, bus bar, bus couplers etc. with respect to tripping in last one year as per latest guidelines of Ramakrishna committee/ CBIP/NRPC/International best practices, which includes review of the following:

- a. Adequacy of primary and backup protection settings for protected equipment and suggest corrective measures.
- b. Availability/healthiness of PLCC communication links used for protection systems.
- c. Healthiness/adequacy of 220/110/50V DC system available at substations for protection application.
- d. Availability/healthiness of GPS system and time synchronization facility used for protection.
- e. Availability/healthiness of recording instruments like DRs /ELs for transmission lines protection.
- f. Test reports for assessing the healthiness of circuit breakers, CT & CVT based upon available test reports at sites.
- g. Field inspection of protection device for obsolescence of technology, suitability and healthiness.
- h. Prepare recommendation for replacement of obsolescence relays with compatible numerical relays will be provided.
- i. Checking of availability of DG Set / auxiliary DC supply at substations.

### **2.3. Audit Rationale**

- a. PTCUL (Utility) has submitted a DPR for Replacement of certain equipment under PSDF scheme to Grid-India. Grid-India has asked PTCUL to carry out protection audit of certain substations.
- b. In addition, as per CERC IEGC 2023 Chapter-04 (Protection Code) Para - 15 (2) “All users shall also conduct third party protection audit of each substation at 220KV and above (132KV and above in NER) once in 5 years or earlier as advised by the respective RPC”.
- c. As per Para – 15 (4) of said Code, “The third-party protection audit report shall contain information sought in the format enclosed as Annexure–1. The protection audit reports, along with action plan for rectification of deficiencies detected, if any, shall be submitted to the respective RPC and RLDC or SLDC, as the case may be, within a month of submission of third-party audit report. The necessary compliance to such protection audit report shall be followed up regularly in the respective RPC”.
- d. Subsequently NRPC issued protection philosophy for Northern region developed in compliance of IEGC 2023, Version 2.0 which was approved in 71<sup>st</sup> NRPC meeting held on 29.01.2024. Accordingly, protection audit of 220KV and above Substations is being carried out by CBIP, as per Annexure -1 of IEGC-2023.

## 2.4. Audit Process

- PTCUL shall provide the following documents:
  - a. The Network Diagram, covering the relevant assets
  - b. Latest relay settings adopted and calculations for respective sub-stations and transmission lines.
  - c. Annual maintenance plan (AMP), including the schedule and activities covered under AMP
  - d. Any specific issues covered under OCC and/or PSC of NRPC for relevant assets.
- For each sub-station, check-list shall be provided by PTCUL. During field visit, the information shall be verified.
- The minimum set of points on which checking and validation shall be carried out is provided as per annexure - 4 for the following available power system elements at station, as per attached formats:

S. No.	Elements
1	Transmission Line
2	Bus Reactor/Line Reactor
3	Inter-Connecting Transformer [ICT]
4	Busbar
5	AC auxiliary system
6	DC auxiliary system
7	Communication system
8	Circuit Breaker Details
9	Current Transformer Details
10	Capacitive Voltage Transformers Details
11	Any other equipment/system relevant for protection system operation

- During field visit, no testing of equipment and relay shall be carried out. The visual inspection, operational log shall be considered for audit purpose, apart from the documents provided by PTCUL.
- A calibrated multi-meter shall be provided at sub-station for checking AC and DC voltages and currents online, wherever feasible, without impacting the sub-station operations.
- The preliminary report shall be prepared on the site and shall be signed by all the parties present, as given below:

S. No.	Issues	Remarks
1	Recommendation of last protection checking and validation	Status of works and pending issues if any
2	Review of existing settings at substation	Recommended Action
3	Disturbance Recorder out/ available for last 6 tripping's (Y/N)	Recommended Action
4	Chronic reason of tripping, if any	Recommended Action
5	Major non-conformity/deficiency observed	Recommended Action

- **The Final summary shall specifically mention minimum following points:**
  - The settings and scheme adopted are in line with agreed protection philosophy or any accepted guidelines (e.g., Ramakrishna guidelines or CBIP manual based).
  - The deviations from the RPC protection philosophy, if any and reasons for taking the deviations shall be recorded.
  - All the major general deficiency shall be listed in detail along with remedial recommendations.
  - The cases of protection maloperation (last 1 year) shall be analysed from tripping reports and the causes of failure along with corrective actions and recommendations based on the findings.



## ***2.5. About Power Transmission Corporation of Uttarakhand (PTCUL)***

The State of Uttarakhand's power transmission utility, PTCUL, was formerly known as Uttaranchal. According to the Uttar Pradesh State Reorganization Act 2000, this 27<sup>th</sup> state of the republic of India was formed on November 9, 2000, by dividing the Himalayan and surrounding North-Western districts of Uttar Pradesh.

The State of Uttaranchal in exercise of the power granted to it under section 63(4) of the State Re-Organization Act, 2000, formed two separate companies in power sector:

- Uttaranchal Jal Vidyut Nigam Ltd. (UJVNL) – For generation of Hydro-Electricity in the State.
- Uttaranchal Power Corporation Ltd. (UPCL) – For Transmission and Distribution of Electricity in the state.

Enactment of the Electricity Act 2003, a distinct watershed in the Indian Power Sector, made it mandatory for all the States to restructure their SEBs. As per the provisions of Electricity Act 2003, the State Government separated power transmission business from UPCL which was left only with distribution of electricity.

In order to manage Power Transmission Operations, a new company called Power Transmission Corporation of Uttaranchal Ltd. was established. On 27<sup>th</sup> May, 2004, the firm was formed as a Government Company in accordance with section 617 of the Companies Act, 1956. It began operating from 1<sup>st</sup> June, 2004.

The company's corporate and registered office is located in Vidyut Bhawan, Saharanpur Road, Majra, Dehradun, next to the ISBT Crossing.

## ***2.6. About Central Board of Irrigation & Power (CBIP)***

The Government of India established the Central Board of Irrigation and Power in 1927, making it a Premier Institution. For the past 93 years, CBIP has provided committed services to the nation's professional associations, engineers, and individuals involved in the power, water resources, and renewable energy sectors. While serving the country equally and to great honour, CBIP has developed into an esteemed institution of international significance. CBIP is Indian chapter for 10 international organizations related to Power & Water resources sectors.

CBIP is involved in executing various activities such as, International Conferences, Technical Documents Publications, Training Activities, Research & Development, Consultancy Services including Technical, Protection & Safety Audits.

### 3.0. Preliminary Audit of 220/132KV Jhajhra Substation

#### 3.1. General Information about Substation

Sl. No.	Particulars	Details
1	Substation Name	220/132 kV Jhajhra Substation
2	Name of Owner Utility	Power Transmission Corporation of Uttarakhand Limited (PTCUL)
3	Voltage Level (s) or highest voltage level	220/132/33KV
4	Short circuit current rating of all equipment (for all voltage level)	220KV level: 40KA 132 KV level: 31.5KA
5	Date of commissioning of the substation	30 <sup>th</sup> January 2014
6	Checking and validation date	29 <sup>th</sup> February 2024 – 1 <sup>st</sup> March 2024

#### 3.2. Audit Team

**Audit Team (CBIP):**

- Mr. Vijay Barthwal
- Mr. M.R. Chauhan
- Mr. Rounak Sen

**PTCUL Representative:**

- Er. Ravindra Kumar Saini, Executive Engineer (T&C)
- Er. Kanchan Nautiyal, Assistant Engineer (T&C)

### ***3.3. Recommendation of last protection checking and validation***

- a. No Protection Audit was carried out earlier.
- b. After a major breakdown at 33KV level happened on 19.07.2023, a committee of PGCIL had visited substation.

### ***3.4. Review of existing settings at substation***

- a. Utility has provided relay settings adopted for various feeders and transformers.
- b. The relay settings are done at station level and record of different relay setting calculations is kept at substation.
- c. All relays are numeric and tested annually.

### ***3.5. Disturbance Recorder availability for the last 6 tripping's***

- a. Utility is submitting Disturbance Recorder data for Inter-State Line 220kV Jhajhra-Sherpur (PGCIL) Line to NRLC Portal.
- b. For transformers and Intra-state lines DR data is taken at station level for analysis purpose.
- c. Utility shall be submitting copy of DR/EL reports subsequently.

### ***3.6. Chronic reason of tripping, if any***

- a. Based on list of tripping submitted by utility of 220 & 132 kV system for last 12 months, following is observed
- b. Most of the feeders are passing thru urban area/ forest area and trippings are happening due to encroachment of line clearance by kite, birds and construction near transmission lines. Protection system is found to be working ok during these cases.
- c. On 30/05/2023, 23/7/2023 and 27/8/2023 multiple LV side of transformers tripped due to fault on 33kV system.
- d. During this period 220kV Vyasi- Jhajhra line tripped 14 times, out of which 10 times it was due to over voltage on remote side. Setting at remote end need to be updated as per latest NRPC guidelines.

- e. During this period 2 nos. tripping from remote end on zone 2 was observed for 220kV khodri line from remote. Settings at remote end needs to be reviewed.
- f. On 17/5/2023 220kV bus-coupler tripped on over current, due to unbalanced load. Setting modified by utility.

### ***3.7. Major non-conformity/deficiency observed***

- a. Bus Bar Protection on 220kV Bus is not functional. Protection is commissioned, but due to non-availability of shut-down, stability test could not be carried out. Expected date for putting in service is 31.03.2024
- b. No Bus Bar Protection is provided for 132kV.
- c. 220kV Khodri line PLCC protection not operational due to issue at other end.
- d. 220kV IIP line PLCC protection is not functional, as protection coupler is not commissioned.
- e. The sub-station is fully operated thru SAS system.
- f. Both the 220V DC systems are replaced recently.
- g. The 220V DC system is configured for single Source DC. Therefore, both the DC sources are connected thru changeover relays at individual bay level to maintain redundancy.
- h. The events are recorded from individual relays, no separate Event Logger is provided. All relays are centrally connected for downloading the DR and EL.
- i. The 2<sup>nd</sup> Auxiliary supply source is currently from 220/132/33 kV transformer tertiary, but not in use. 2<sup>nd</sup> station transformer connected to 33kV bus is under commissioning.

## 4.0. Tripping Statements

NAME OF SUBSTATION	TYPE OF RELAY	TRIPPING DATE/TIME	CLOSING DATE/TIME	FLAGS & INDICATION OBSERVED	ANALYSIS WITH DISCREPENCY IN FLAGS	PRE-FAULT Load	POST FAULT	REMARK
Dhakrani PH	GE-D60	06.12.22 / 06.03	06.12.22/ 06.20	Flags: DIR O/C E/F PROT OPTD, 86 OPTD, 50/51 Trip, AC supply fail	Dir O/C & E/F OPTD. Power supply fail at Dhakrani PH.	NA	NA	Setting of Dir. O/C & E/F relay @ Dhakrani PH should be reviewed.
Dhalipur PH	GE-D60	06.12.22 /	06.12.22/	NA		NA	NA	
Dhakrani PH	GE-D60	06.12.22 / 06.03	06.12.22/ 07.25	Flags: DIR O/C E/F PROT OPTD, 86 OPTD, 50/51 Trip, AC supply fail	Dir O/C & E/F OPTD. Power supply fail at Dhakrani PH.	NA	NA	Setting of Dir. O/C & E/F relay @ Dhakrani PH should be reviewed.
Khodri PH	GE-D60	06.12.22 /	06.12.22/	NA		NA	NA	
Dhakrani PH	GE-D60	07.12.22 / 13.12	07.12.22/ 15.51	Flags: DIR O/C E/F PROT OPTD, 86 OPTD, 50/51 Trip	Dir O/C & E/F OPTD. Power supply fail at Dhakrani PH.	NA	NA	Setting of Dir. O/C & E/F relay @ Dhakrani PH should be reviewed.
Khodri PH	GE-D60	07.12.22 /	07.12.22/	NA		NA	NA	
Kulhal PH	GE-D60	07.12.22 / 13.13	07.12.22/ 13.40	Flags: DIR O/C E/F PROT OPTD, 86 OPTD, 50/51 Trip, B phase O/C Trip	Dir O/C & E/F OPTD. Power supply fail at Kulhal PH.	NA	NA	Setting of Dir. O/C & E/F relay @ Dhalipur should be reviewed.
Dhalipur PH	GE-D60	07.12.22 /	07.12.22/	NA		NA	NA	
220KV S/S Jhajhra	GE-D60	25.12.22 / 11.20	25.12.22/ 14.15	Flags: N/G,86A/B, Zone-1, starting AN, trip ABC, Fault timing- 61.45msec, RTT,	LEFT	NA	Ia=11.62 KA Ib=94.64 A Ic=33.72 A	Frequently Line patrolling required by O&M concern.

NAME OF SUBSTATION	TYPE OF RELAY	TRIPPING DATE/TIME	CLOSING DATE/TIME	FLAGS & INDICATION OBSERVED	ANALYSIS WITH DISCREPENCY IN FLAGS	PRE-FAULT Load	POST FAULT	REMARK
				111.3msec, FL-4.065Km, FR-378.7mohm.				
Vyasi PH		25.12.22 / 11.20	25.12.22/ 14.20	O/C & E/F trip, Group-1, Trip relay 86A,86MIR,86MIY,86MIB, Group-B,trip relay86B,86M2R, 86M2Y,86M2B, 8541/ z1, 21M2-3Px, 85y2/z2,21M1-3Px			Ia=1.426 K Ib=81.32 A Ic=16.56 A	
220KV Jhajhra	GE Multilin D60/ Alastom P442	18.01.23 / 16:21	18.01.23/ 17:31	Flags: Active Grp 1, Started Phase AN, Tripped Phase ABC, Start Element Dist, DIST Trip Z1, Fault Record-AR, Lock Out Start, Freq: 49.90 Hz, FD: 61.79ms, RTT: 110.2ms, FL: 4.036Km, Resistance: 409.9ohm CB No.80 Bus Coupler tripped. Flags: Phase IOC1 Trip OP, Phase A IOC1 Trip OP.	LEFT, a bird came near the range of line results tripping of line.		Ia: 12.08KA Ib: 264.1 A Ic: 236.59A Van: 27.33 KV Vbn: 129.5KV Vcn: 127.6KV	NA
Vyasi PH	GE D-60	18.01.23 / 16.25	18.01.23/	Flags: Trip Relay 86 A & 86 B OPTD, E/F start			IA: 47.29A IB:	NA

NAME OF SUBSTATION	TYPE OF RELAY	TRIPPING DATE/TIME	CLOSING DATE/TIME	FLAGS & INDICATION OBSERVED	ANALYSIS WITH DISCREPENCY IN FLAGS	PRE-FAULT Load	POST FAULT	REMARK
				in 1, FL: 69.14km, FR: 2.469 Ohm, Fault in Zone 3			47.25A IC: 44.17A VAN: 131.5KV VBN: 134.9KV VCN: 132.4KV	
220KV Jhajhra	GE Multilin D60/ Alastom P442	18.01.23	18.01.23	Tripping not observed.		NA	NA	
Khodri PH	GE D-60	18.01.23 /16.25	18.01.23	Flags: DIR. O/C & E/F OPTD, AC Supply fail. Main 2: DIST PROT OPTD, 86 A& B OPTD, VT fuse fail, FD: 86.84ms, FL: 44.45KM, FR: 1.960 Ohm, Fault in Zone 3.		NA	IA: 2.27 KA IB: 609.0 A IC: 191.0 A VAN: 65.83 KV VBN: 125.7 KV VCN: 123.6 KV	Setting of relay should be reviewed at Khodri end.
220KV IIP	Alstom P-442 and GE D-60	26.01.23 / 13.58  Tried to close line but not hold.	26.01.23/ 14.37  26.01.23/ 15.30	Flags: Master trip relay 1/2 OPTD, Fault in Z1, FD: 8.937 KM, , Freq: 50.13Hz, FD: 51.54 ms, RTT: 79.80 ms, Main PROT & Back up PROT Master trip relay OPTD.	A kite came in the range of Line.	81 A 8.12 MW(E )	IA: 81.50A IB: 4.32KA IC: 4.271KA VA: 132.3KV VB: 69.86KV VC: 65.31KV	NA



NAME OF SUBSTATION	TYPE OF RELAY	TRIPPING DATE/ TIME	CLOSING DATE/ TIME	FLAGS & INDICATION OBSERVED	ANALYSIS WITH DISCREPENCY IN FLAGS	PRE-FAULT Load	POST FAULT	REMARK
		26.01.23 / 14.37		Flags: Master trip relay 1/2 OPTD, Fault in Z1, FD: 8.979 KM, Freq: 49.94Hz, FD: 61.74 ms, RTT: 80.10 ms, FR: 258.2 Ohm. Main PROT & Back up PROT Master trip relay OPTD.Under Voltage Relay Flag on B&C fuse.			IA: 10.87A IB: 4.413KA IC: 4.413KA VA: 131.8KV VB: 69.67KV VC: 65.7KV	
220KV Jhajhra	GE Multilin D60/Alastom P442	26.01.23 / 14.01	26.01.23/ 15.31	Flags: Active Grp1, Start Phase BC, Tripped Phase ABC, Start Dist, Trip Zone 1, FD: 71.49 ms, RTT: 79.80 ms, FL: 15.31KM, FR: 187 ohm, 86 A trip,		79 A 12.1 MW(I)	IA: 62.79A IB: 7.219KA IC: 7.267 KA, VAN: 133.4KV VBN: 85.45KV VCN: 75.60KV	NA
220KV Jhajhra	GE Multilin D60/Alastom P442	26.01.23 / 14.01	26.01.23/ 15.58	Flags: 86 A .	LEFT, Due to Over Voltage	NA	NA	NA
Vyasi PH	GE D-60	26.01.23 / 13.58	26.01.23/ 13.58	Flags: Grp 1: Tripping relay 86 A, ABC Phase Dist. Trip. Grp 2: Tripping	Breaker tripped at other end.	NA	IA: 18 A IB: 18 A C: 18 A VAN: 138.8KV	NA

NAME OF SUBSTATION	TYPE OF RELAY	TRIPPING DATE/TIME	CLOSING DATE/TIME	FLAGS & INDICATION OBSERVED	ANALYSIS WITH DISCREPENCY IN FLAGS	PRE-FAULT Load	POST FAULT	REMARK
				relay 86 B, ABC Phase Dist. Trip.			VBN: 138.8KV VCN: 138.8KV	
220KV Jhajhra	GE Multilin D60/Alastom P442	30.01.23 / 01.44	30.01.23	Flags: 86 A & 86 B trip.	Due to Over Voltage Breaker tripped at other end.	NA	NA	NA
Vyasi PH	GE D-60	30.01.23 / 1.48	30.01.23	Flags: Overvoltage GRP 86 A/86B.	NA	NA	NA	NA
220KV Jhajhra	GE Multilin D60/Alastom P442	30.01.23 / 2.14 tried to charge line from Vyasi end	30.01.23	Flags: 86 A & 86 B trip.	NA	NA	NA	NA
Vyasi PH	GE D-60	30.01.23 / 2.18	30.01.23/	Flags: Overvoltage GRP 86 A/86B.	NA	NA	NA	NA
220KV Jhajhra	GE Multilin D60/Alastom P442	30.01.23 / 03.00	30.01.23/ 10.57	Flags: 86 A & 86 B trip.	NA	NA	NA	NA
Vyasi PH	GE D-60	30.01.23 / 03.00	30.01.23/ 11.00	Flags: Overvoltage GRP 86 A/86B.	NA	NA	NA	NA

NAME OF SUBSTATION	TYPE OF RELAY	TRIPPING DATE/TIME	CLOSING DATE/TIME	FLAGS & INDICATION OBSERVED	ANALYSIS WITH DISCREPENCY IN FLAGS	PRE-FAULT Load	POST FAULT	REMARK
220 KV S/S Jhajhra	GE Multilin e D60/ Alstom P442	21.02.23 / 20.03	21.02.23/ 20.07	86- A&B, Phase BC, LBB In-ON, Zone-2, AR Block, Started Phase BC, Tripped Phase ABC, Dist Z2, Gr-A 3 Phase Trip relay, FD: 462.5ms, RTT: 79.86 5ms, FL: 21.23 km, FR: 118.5 mohm	Line was tripped due to Hail storm with raining.	92 A 14 MW	IA=116.8 A IB= 6.008 KA IC= 5.976 KA VAN=131.5 KV VBN: 88.22 KV VCN=83.77 KV	NA
220 KV S/S IIP	Alstom P-442 and GE D-60	21.02.23 / 20.07	21.02.23/ 21.38	DIST Relay -1- Fault Phase B&C. Dist Relay -2- Freq: 50.09Hz, FD: 59.89 ms, FL: 2.945 km, R.T.T: 79.86 ms, FR: 443.6 m ohm, Fault ion Zone 1.		105 A -10 MW	IA=126.1 A IB= 4.706 KA IC= 4.788 KA VAN=130 KV VBN: 67.2 KV VCN=62.4 KV	NA
220KV Jhajhra	GE Multilin e D60/ Alstom P442	08.03.23 / 20:25	08.03.23/ 20:51	86 A & 86 B.	Due to Over Voltage Breaker tripped at other end.	(-8 MW) (-40 Amp)		NA
Vyasi PH	GE D60	08.03.23 / 20:25	08.03.23/ 20:56	GRP 1: Trip relay 86 A . Main 1- R phase DIST trip 86 M1R, Y phase DIST trip 86 M1Y, B phase DIST trip 86		NA	NA	NA

NAME OF SUBSTATION	TYPE OF RELAY	TRIPPING DATE/TIME	CLOSING DATE/TIME	FLAGS & INDICATION OBSERVED	ANALYSIS WITH DISCREPENCY IN FLAGS	PRE-FAULT Load	POST FAULT	REMARK
				M1B. GRP 2: Trip relay 86 B . Main 2- R phase DIST trip 86 M2R, Y phase DIST trip 86 M2Y, B phase DIST trip 86 M2B.				
220KV Jhajhra	GE Multilin e D60/ Alstom P442	09.03.23 / 00:27	09.03.23/ 05:45	86 A & 86 B.	Due to Over Voltage Breaker tripped at other end.	(-4.2 MW) (-35 Amp)	NA	NA
Vyasi PH	GE D60	09.03.23 / 00:27	09.03.23/ 05:51	GRP 1: Trip relay 86 A . Main 1- R phase DIST trip 86 M1R, Y phase DIST trip 86 M1Y, B phase DIST trip 86 M1B. GRP 2: Trip relay 86 B . Main 2- R phase DIST trip 86 M2R, Y phase DIST trip 86 M2Y, B phase DIST trip 86 M2B.		NA	NA	NA
220KV Jhajhra	GE Multilin D60/ Alastom P442	11.03.23 / 12:36	11.03.23/ 13:55	3 Phase trip, Zone 1, FL: 7.642 KM, FD: 70.10ms, RTT: 80.12ms, FR: 404.4 mohm	A kite came in the range of line cause line trip.	340 A 114 MW	IA= 262.9 A IB= 3.349 KA IC= 3.50	NA

NAME OF SUBSTATION	TYPE OF RELAY	TRIPPING DATE/TIME	CLOSING DATE/TIME	FLAGS & INDICATION OBSERVED	ANALYSIS WITH DISCREPENCY IN FLAGS	PRE-FAULT Load	POST FAULT	REMARK
							KA VAN=122.6 KV VBN=70.59 KV VCN=63.91 KV	
Khodri PH		11.03.23 / 12:36	11.03.23/ 14:01	Main DIST PROT OPTD, Auto recloser Unsuccessful, AC Supply fail. Main 2 DIST PROT OPTD, 86 A & B OPTD, Dist Trip Z1, fd: 60.09 ms, RTT: 80.12ms, FL: 18.80KM, FR: 988.5 m ohm		(-96 MW)	IA= 265.6 A IB=8.83 KA IC=8.69 KA VAN=124.9 KV VBN=71.43 KV VCN=63.57 KV	NA
220KV Jhajhra	GE Multilin e D60/ Alstom P442	18.03.23 / 03:37	18.03.23/ 06:56	Grp A, 3 Phase trip relay, 86 A & 86 B.		(-11.3 MW) (-43 Amp)	NA	NA
Vyasi PH	GE D60	18.03.23 / 03:38	18.03.23/ 07:01	GRP 1: Trip relay 86 A . Main 1- R phase DIST trip 86 M1R, Y phase DIST trip 86 M1Y, B phase DIST trip 86 M1B. GRP 2: Trip relay 86 B . Main 2- R phase DIST trip 86	Due to Over Voltage Breaker tripped at other end.	10.59 MW 28.54 Amp	NA	NA

NAME OF SUBSTATION	TYPE OF RELAY	TRIPPING DATE/TIME	CLOSING DATE/TIME	FLAGS & INDICATION OBSERVED	ANALYSIS WITH DISCREPENCY IN FLAGS	PRE-FAULT Load	POST FAULT	REMARK
				M2R, Y phase DIST trip 86 M2Y, B phase DIST trip 86 M2B.				
220KV Jhajhra	GE Multilin e D60/ Alstom P442	21.03.23 / 02:20	21.03.23/ 06:38	Grp A, 3 Phase trip relay, 86 A & 86 B.	Due to Over Voltage Breaker tripped at other end.	(-11.9 MW) (-43 Amp)	NA	NA
Vyasi PH	GE D60	21.03.23 / 02:25	21.03.23/ 06:44	86 A & 86 B OPTD.		11.38 MW 30.28 Amp	NA	NA
220KV Jhajhra	GE Multilin e D60/ Alstom P442	30.03.23 / 20:13	30.03.23/ 23:48	86 A & B.	Due to Over Voltage Breaker tripped at other end.	(-80A) (-30.5 MW)	NA	NA
Vyasi PH	GE D60	30.03.23 / 20:14	30.03.23/ 23:48	86 A & B. Main 1 R phase Dist. Trip 861MR, 862MR. Y Phase MIY, 86 M2Y. B Phase- 86 M1B, 86 M2B. 86A trip relay coin supervision 74A & 74B.		NA	NA	NA
220KV Jhajhra	GED- 60, F 650	30.03.23 / 20:22 tried to close breaker @ Jhajhra	31.03.23/ 00:07	B & C Phase O/C, Phase DIST Z1, 86 A , 86 B, F.D: 7.8 KM, Active Grp A.	Line was tripped due to falling of tree in Jhajhra- Majra Line.	132 A 30.5 MW	IA=139 A IB=5.5 KA IC=5.4 KA VAN = 81.81 KV VBN =	NA

NAME OF SUBSTATION	TYPE OF RELAY	TRIPPING DATE/TIME	CLOSING DATE/TIME	FLAGS & INDICATION OBSERVED	ANALYSIS WITH DISCREPENCY IN FLAGS	PRE-FAULT Load	POST FAULT	REMARK
		end but not hold tripped @ 21:05		B & C, Phase O/C, Phase DIST Z1, 86 A , 86 B, F.D: 7.8 KM, Active setting Grp A.			50.1 KV VCN = 43.1 KV  IA=000A IB=6.6KA IC=6.7 KA	
132 KV Majra		30.03.23 / 20:23	31.03.23/ 00:08	Main Relay-DIST PROT OPTD, DIST start. CP: Master trip relay 86-1 & 2. DIST PROT relay 1,3,4,5, Fault event, DIST PU, L2-3 ON, DIST trip 3P ON, Definitive trip ON, EF Trip block ON, Dist 5.7 KM. Backup Relay- 3,4,5 DIR O/C, PU-ON, DIR L2, L3 PU-ON.		(-31.6 MW) (-138 A)	I1=0.11 KA I2=4.79 KA I3=4.88 KA	NA
220KV S/S Jhajhra	GE Multilin e F-650	10.04.23 / 12:01	10.04.23/ 12:01	B Phase , C Phase Tripped, Z1 trip, 86 OPTD, F.L: 19.9 KM	Line was trip due to the kite came in the range of line.	(-5.8 MW) 27 Amp	IA=0 IB=3.81 KA IC=3.83 KA	NA
Kulhal PH	GE- D 60	10.04.23 / 12:05	10.04.23/ 12:28	DIST PROT OPTD, B Phase , C phase Tripped, Z1 trip, 86 OPTD, F.L: 9.7 KM		(-5 MW) 27 Amp		NA
220 KV S/S	NA	20.04.23 /	21.04.23/ 00:47	86 B OPTD.	Line was trip due to the	40 MW	IA=4.83 KA	Breaker close from

NAME OF SUBSTATION	TYPE OF RELAY	TRIPPING DATE/ TIME	CLOSING DATE/ TIME	FLAGS & INDICATION OBSERVED	ANALYSIS WITH DISCREPENCY IN FLAGS	PRE-FAULT Load	POST FAULT	REMARK
		23:47 21.04.23 / 00:47		Fault type BG, 86 A OPTD, F.L: 9.6 KM	damage of Y phase Jumper.	172 Amp	IB=4.83 KA IC=0  IA=0 KA IB=7882. 8 A IC=0 IG=7886. 45 A	Jhajhra but not close trip again.
132 KV S/S Purkul	NA	20.04.23 / 23:47	21.04.23/ 10:46	186, 86T,86T,86T OPTD. R. P: Active Grp 1, Started Phase A,B, Trip Phase ABC, Started element DIST, O/C>1, DIST Start-Z1, F.D: 73.40 ms, R.T.T: 80.08 ms, F.L: 2.088 KM, F.R: 80.7 mohm, Fault in Zone 1		178 Amp -40.8 MW	IA= 2.95 KA IB= 3.063 KA IC= 131.0A VAN= 40.37 KV VBN= 39.30 KV VCN = 80.07 KV	NA
220 KV S/S Jhajhra	GE-350	17.05.23 / 20:18	17.05.23/ 21:20	Phase TOC1 OPTD, 86.	Due to Over Current T/F I & II tripped with Bus Coupler. O/C setting was BDOA as per UPSEB norms. As B/C tripped both 220KV bus independent and 160 MVA T/F tripped.		IA= 773 AA IB=761.5 A IC= 793.5 A	O/C Setting has been reviewed and on 1600 A after checking capacity of CB, CT, Isolator and Jumper.
220 KV S/S Jhajhra	GE Multilin e T-60/ F650 / 7SR350	17.05.23 / 20:20	17.05.23/ 21:15	86 A& B		124.3 MW 345 A		
220 KV S/S Jhajhra	F650	17.05.23 / 20:20	17.05.23/ 21:15	86 A& B , Phase TOC1 ABC high			Ia=0.767 KA Ib=0.775	



NAME OF SUBSTATION	TYPE OF RELAY	TRIPPING DATE/TIME	CLOSING DATE/TIME	FLAGS & INDICATION OBSERVED	ANALYSIS WITH DISCREPENCY IN FLAGS	PRE-FAULT Load	POST FAULT	REMARK
				OPTD, Phase ABC O/C.			KA Ic=0.771 KA Ig=0.004 KA Vab=125.76 KV Vbc=126.72 KV Vca=125.95 KV	
220 KV S/S Jhajhra	GE-T 60/F650 /7SR350	17.05.23 / 20:19	17.05.23/ 20:57	86 A& B		109.7 MW 304 A		
220 KV S/S Jhajhra	F650	17.05.23 / 20:19	17.05.23/ 21:00	86 A& B, Phase TOC1 ABC high OPTD, Phase ABC O/C.			Ia=0.750 KA Ib=0.740 KA Ic=0.752 KA Ig=0.009 KA Vab=129.98 KV Vbc=130.08 KV Vca=129.98 KV	
Khodri PH	GE-D60	17.05.23 / 20:25	17.05.23/ 21:30	86 A, 80A, 80 B, 86 C, 86. SSR3V PROT. Trip, 132 KV Pole discrepancy trip, VT fuse Fail, CB CKT Faulty	Due to AC supply fail at Dhakrani PH. Tripped from Khori end due to O/L.	98 MW	NA	NA
Dhakrani PH	GE-D60	17.05.23 / 20:30	17.05.23/ 21:26	No Flag noted by Dhakrani PH		39 MW	NA	NA

NAME OF SUBSTATION	TYPE OF RELAY	TRIPPING DATE/TIME	CLOSING DATE/TIME	FLAGS & INDICATION OBSERVED	ANALYSIS WITH DISCREPENCY IN FLAGS	PRE-FAULT Load	POST FAULT	REMARK
220 KV S/S Jhajhra	GE Multilin e D60/ Alstom P442	18.05.23 / 02:23	18.05.23/ 08:04	GRP A, GRP B, 3 Phase Trip, 86 A& B.		26.6 MW 79 A (I)		
Vyasi PH	GE-D60	18.05.23 / 02:35	18.05.23/ Breaker closed @ Vyasi end at 06:50Hrs but not hold trip same time	Tripped on O/V.	Due to Over Voltage Breaker tripped at Vyasi PH end.	19.30 MW 53.16 A		Action taken by UJVN Ltd. End setting of O/V relay shall be reviewed.
220 KV S/S Jhajhra	GE Multilin e T-60/ F650 / 7SR350	30.05.23 / 08:22	30.05.23/ 08:28	86 A, 86 B	Due to heavy current fault (Phase to Phase fault) in 33 KV feeder in Selaqui-I & Linde Near yard.		IA=0.65 KA IB= 7.812 KA IC= 1.132 KA VAB= 21.64 KV VBC= 19.72 KV VCA= 34.03 KV	Action taken by UPCL.
220 KV S/S Jhajhra	GE Multilin e T-60/ F650 / 7SR350	30.05.23 / 08:22	30.05.23/ 08:28	86 A, 86 B, E/F	NA	NA	IA=0.688 KA IB= 7.748 KA IC= 1.043 KA VAB=	

NAME OF SUBSTATION	TYPE OF RELAY	TRIPPING DATE/TIME	CLOSING DATE/TIME	FLAGS & INDICATION OBSERVED	ANALYSIS WITH DISCREPENCY IN FLAGS	PRE-FAULT Load	POST FAULT	REMARK
							21.96 KV VBC= 19.27 KV VCA= 33.76 KV	
220 KV S/S Jhajhra	GE Multilin e T-60/ F650 / EE	30.05.23 / 08:22	30.05.23/ 08:40	86 A, 86 B	NA	NA	IA=0.683 KA IB= 7.659 KA IC= 1.113 KA VAB= 21.76 KV VBC= 19.58 KV VCA= 34.00 KV	Action taken by UPCL.
220 KV S/S Jhajhra	GE Multilin e T-60/ F650 / EE	30.05.23 / 08:22	30.05.23/ 08:41	86 A, 86 B, E/F	NA	NA	IA=0.731 KA IB= 7.721 KA IC= 1.001 KA VAB= 21.868 KV VBC= 19.176 KV VCA= 33.67 KV	
220 KV S/S Jhajhra	GE Multilin e T-60 / 7SR350	02.06.23 / 22:12	03.06.23/ 06:35	GR-A LBB, GR- B LBB, OLTC R Phase, 30 CD, 30GH, 86 A, 86 B, OSR Trip U- Phase	160 MVA T/F - II trip on OSR.	188 A 72.9 MW	NA	NA

NAME OF SUBSTATION	TYPE OF RELAY	TRIPPING DATE/TIME	CLOSING DATE/TIME	FLAGS & INDICATION OBSERVED	ANALYSIS WITH DISCREPENCY IN FLAGS	PRE-FAULT Load	POST FAULT	REMARK
220 KV S/S Jhajhra	GE Multilin e T-60/F650	02.06.23 / 22:12	03.06.23/ 06:48	86 trip		NA	NA	
220KV S/S JHAJHRA	GE T-60/F650	23.07.23 / 18:03	23.07.23/ 18:23	86A, 86B OPTD.	80mva T/F-2 CB. No.- 784/384 Tripped with 33kv CB. No.- 07 Selaqui-1 feeder	24 MW 102 A	Ia=0.055K A Ib=0.058 K A Ic=0.065 KA Ig=0.002 KA	NA
220KV S/S JHAJHRA	F650	23.07.23 / 18:03	23.07.23/ 18:25	O/C & E/F on B-phase, 86A & 86B optd.		NA	Ia=0.558KA Ib=0.531 KA Ic=8.480 KA Ig=8.326 KA	NA
220KV S/S JHAJHRA	Alstom P-442 and GE D-60	26.07.23 / 06:35	26.07.23/ 08:47	Main -1: Phase CN, GND Dist. Z2, OPTD LBB. Main-2: Started Phase CN, Tripped Phase ABC, Started element DIST, DIST Trip Z2, F.D: 442.3ms, R.T.T: 80.11 ms, F.L: 22.02km, F.R: 507.8-ohm, 86 A&B OPTD.	A branch of tree came in the range of line between Tower No.76-77.	96 A -0.4 MW	Ia=15.06 A Ib=152.7 A Ic=4.555 KA Van=146.8 KV Vbn=148.7 KV Vcn=13.93 KV	NA
220 KV IIP	Alstom P-442 and GE D-60	26.07.23 / 06:33	26.07.23/ 08:48	Master trip 1/2, Started Phase CN, Tripped Phase ABC, Dist. Trip		106 A - 3.61M W	Ia=15.06 A Ib=152.7 A	NA

NAME OF SUBSTATION	TYPE OF RELAY	TRIPPING DATE/TIME	CLOSING DATE/TIME	FLAGS & INDICATION OBSERVED	ANALYSIS WITH DISCREPENCY IN FLAGS	PRE-FAULT Load	POST FAULT	REMARK
				Z1, F.D:60.09ms, R.T.T: 80.11 ms, F.L: 1.309 KM, F.R: 2.67-ohm, Fault in Zone 1.			Ic=4.555 KA Van=146. 8 KV Vbn=148. 7 KV Vcn=13.9 3 KV	
220KV S/S JHAJHRA	GE D-60/ Alstom P-442	26.07.23	26.07.23	No. tripping observed	NA	306 A 119.7 MW (Exp.)	NA	NA
Khodri P/H	NA	26.07.23 / 06:34	26.07.23/ 07:30	Feeder prot. Optd., no trip alarm, active group-1, Dir O/C & E/F prot. Optd., std. phase earth fault, start IN tripped Elts no, F.D:105.2ms, R.T.T: 0.00s, 86a & 86B, fault in zone none		124 MW(I)	Ia=409.6 A Ib=172.4 A Ic=9863 A Van=131. 6 KV Vbn=132. 5 KV Vcn=101 KV	NA
220 KV IIP	Alstom P-442 and GE D-60	26.07.23 6:33	26.07.23 8:48	Master trip 1/2 , Started Phase CN, Tripped Phase ABC, Dist. Trip Z1, F.D:60.09ms, R.T.T: 80.11 ms, F.L: 1.309 KM, F.R: 2.67 ohm, Fault in Zone 1.	A tree came in the range of line between tower no. 76-77.	106 A - 3.61M W	Ia=15.06 A Ib=152.7 A Ic=4.555 KA Van=146. 8 KV Vbn=148. 7 KV Vcn=13.9 3 KV	NA

NAME OF SUBSTATION	TYPE OF RELAY	TRIPPING DATE/TIME	CLOSING DATE/TIME	FLAGS & INDICATION OBSERVED	ANALYSIS WITH DISCREPENCY IN FLAGS	PRE-FAULT Load	POST FAULT	REMARK
220 KV Jhajhra	GE Multilin D60/ Alastom P442	26.07.23 / 06:35	26.07.23/ 08:47	Main -1: Phase CN, GND Dist. Z2, OPTD LBB. Main-2: Started Phase CN, Tripped Phase ABC, Started element DIST, DIST Trip Z2, F.D: 442.3ms, R.T.T: 80.11 ms, F.L: 22.02km, F.R: 507.8-ohm, 86 A&B OPTD.	NA	96 A -0.4 MW	Ia=15.06 A Ib=152.7 A Ic=4.555 KA Van=146.8 KV Vbn=148.7 KV Vcn=13.9 3 KV	NA
220KV S/S JHAJHRA	GE D-60/ Alstom P-442	15.08.23 13:32	25.87.23 14:07	Phase A, N/G, Carrier send Zone - 01 Trip, R phase trip, tripped ABC, std. phase AN, dist. - Z1, F.D : 76.53ms, R.T.T : 79.86ms, F.L : 6.8km, F.R : 16.11 ohm fault in zone : 1	A bird came in the range of Line.	148 A 41MW 23mvr (Exp.)	Ia=5932 A Ib=85.12 A Ic=75.104 A Van=93 KV Vbn=132.14 KV Vcn=130.24 KV	NA
Khodri P/H	NA	15.08.23 13:33	25.87.23 14:11	Dir. O/C, E/F optd. Main - 2: Dist. Prot. Optd., Active group-1, std. phase AN, Earth fault std. IN-1, F.D: 139.7ms, R.T.T : 00s, F.L : 30.91km, F.R : 37.96 ohm, Failt		48 MW 25mvr (imp.)	Ia=1.835 KA Ib=88.6 A Ic=114.7 A Van=110.1 KV Vbn=125.7 KV Vcn=128 KV	NA

NAME OF SUBSTATION	TYPE OF RELAY	TRIPPING DATE/TIME	CLOSING DATE/TIME	FLAGS & INDICATION OBSERVED	ANALYSIS WITH DISCREPENCY IN FLAGS	PRE-FAULT Load	POST FAULT	REMARK
				in zone : 3 86a & 86B optd.				
220KV S/S JHAJHRA	GE D-60/Alstom P-442	16.08.23 / 15:01	The line is in S/D	Active group-1, Earth fault, F.D: 96.53ms, R.T.T: 00s, Fault zone none 86A & 86B optd., 3 Phase trip relay	Due to landslide at tower No.: 93	73 MW 195 Amp	Ia= 156.9 A Ib=90.61 A Ic=732.9 A Van=125.2KV Vbn=128.2 Vcn=123.4KA	NA
Vyasi P/H		16.08.23 / 15:02		86A, 86B OPTD.		72.9M W 190.1a mp	NA	
220KV S/S JHAJH	GE D-60/F650	27.08.23 / 08:34	27.08.23/ 09:02	E/F trip, 86A, 86B OPTD.	80mva T/F-1&2 CB. No.-784/384 &783/383 Tripped with 33kv CB. No.-09 AWHO (Future Bay) feeder due to heavy blast & LA damage of y phase on 33kv AWHO feeder	34 mw 151 A 9 mvr	NA	
220KV S/S JHAJHRA	F650	27.08.23 / 08:34	27.08.23/ 09:08	E/F trip, 86 optd.		Ia= 0.614K A Ib=8.2 4KA Ic=7.6 16KA Ig=7.8 4KA	Ia= 0.524KA Ib=8.10K A Ic=7.915 KA Ig=7.652 KA	NA
220KV S/S JHAJHRA	GE D-60/Alstom P-442	27.08.23 / 08:34	27.08.23/ 09:01	E/F trip, 86A, 86B OPTD.		152 A 33MW	NA	NA
220KV S/S JHAJHRA	F650	27.08.23 / 08:34	27.08.23/ 09:06	E/F trip, 86 optd.		Ia= 0.571K A Ib=8.1	Ia= 0.497KA Ib=8.056 KA	NA

NAME OF SUBSTATION	TYPE OF RELAY	TRIPPING DATE/TIME	CLOSING DATE/TIME	FLAGS & INDICATION OBSERVED	ANALYSIS WITH DISCREPENCY IN FLAGS	PRE-FAULT Load	POST FAULT	REMARK
						69KA Ic=7.9 7KA Ig=8.1 7KA	Ic=7.89K A Ig=7.69K A	
220KV S/S JHAJHRA	GE D-60/ Alstom P-442	05.09.23 / 00:34	05.09.23/13:21	Fault type-AG, N/G, Zone-1, 86A optd., F.L: 5.6KM	Due to the strom some object within the range of the conductor	130 A 29MW (I)	Ia=13859. 16A Ib=7154 A Ic=102.67 A	NA
Dhalipur P/H	GE Multilin D-60/F650	05.09.23 00:35	05.09.23 13:20	Dist. Prot. Optd., phase A, GND Dist.-Z1, N/G optd., 86 optd.	Tower No:26-27	88Amp 17MW (E)	NA	NA
220KV S/S JHAJHRA	GE D-60/ Alstom F650	15.09.23 / 02:37	15.09.23/ 03:25	R-phase, Y-phase, B-phase trip, 86 optd., F.L: 23km	Line was tripped due to lightning at Tower No :33-35	39 A 8 MW 1 mvr (Imp.)	Ia= 3459.155 A Ib= 3353.098 A Ic=3492.6 85A	NA
Kulhal P/H	GE D-60/ Alstom F650	15.09.23 / 02:40	15.03.23/ 09:27	Dist. Prot. Optd., Dir. O/C & E/F optd., Dist. Prot. Relay optd., trip a-phase, B-phase & C-phase, GND Z1 optd., Dir. O/C & E/F Relay trip A-phase, B-phase, c-phase, O/C trip, 86 optd.		41 A 9 MW -2 mvr (Exp.)	NA	NA
220 KV S/S IIP	Alstom P-442 and GE D-60	19.09.23 / 12:18	19.09.23/ 12:59	Started Phase ABC, Fault type CG, Fault in Zone 2, F.D.-393.7 ms,	A Monkey came in the range of the line between	125 A -22 MW	IA=10.6 A IB=11.28 A	NA



NAME OF SUBSTATION	TYPE OF RELAY	TRIPPING DATE/TIME	CLOSING DATE/TIME	FLAGS & INDICATION OBSERVED	ANALYSIS WITH DISCREPENCY IN FLAGS	PRE-FAULT Load	POST FAULT	REMARK
				Fault freq.- 49.95 HZ,Fault resistance-25.59 ohm, R.T.T.- 80.08 ms, F.L.- 21.31 KM	Tower No: 17-18		IC=2.328 KA VAN=133.8 KV VBN=125 KV VCN=77.03 KV	
220 KV S/S Jhajhra	Alstom P444 / P143	19.09.23 / 12:18	19.09.23/ 12:59	86 A, start phase CN , tripped phase ABC, start element distance , Earth fault start IN 1, distance trip , Z1, F.D.- 80.08 ms , R.T.T.- 80.08 ms, F.R.-23.43 ohm,F.L.-12.07 km		93 A 8 MW(E )	IA=24.39 A IB=185.7 A IC=3.878 KA VAN=128.6 KV VBN=127.2 KV VCN=109.4 KV	NA
220KV S/S Jhajhra	GE Multilin e D-60/F650	23.09.23 14:35	23.09.23 15:54	Gr-A, 3 Phase trip Relay, Dist. Z1, Carrier send Ph Dist. Z1, Main 86A/86B, A.R Block, fault AG, F.L: 3.8km, Element GND Dist Z1, Element-2 SRC 1 50DD	Due to children getting caught in the line tower No: 19-20	83 Amp 18 MW (I)	Ia=16447.586 A Ib=116.483 A Ic=131.915 A In=16666.907A Va=35703.684 V Vbn=75026.824V Vcn=74013.162V	NA
Dhalipur P/H	GE Multilin e D-60/F650	23.09.23 14:35	23.09.23 15:56	Dist. Prot. Optd., 86 Optd.		16.6 Amp 71	NA	NA

NAME OF SUBSTATION	TYPE OF RELAY	TRIPPING DATE/TIME	CLOSING DATE/TIME	FLAGS & INDICATION OBSERVED	ANALYSIS WITH DISCREPENCY IN FLAGS	PRE-FAULT Load	POST FAULT	REMARK
						MW (E)		
220KV S/S Jhajhra	GE Multilin e D-60/Alstom P442	29.09.23 06:25	29.09.23 09:48	C.P- Y-phase trip, Zone-1 optd., 86A,86B optd. R.P- Active group-1, std. phase BN, Tripped phase B, Start element Distance, Earth fault start In-1, Dist. Trip Zone-1, F.D: 71.87ms, R.T.T: 80.23ms, F.L: 10. 52KMF.R: 972.2MOhm,	Line tripped due to vulture coming on cross arms tower no.-20	117 A -44 MW (I)	Ia= 349 A Ib= 10.10 KA Ic= 545.7 A Van=130.2 KV Vbn 57.68 KV Vcn=130.9KV	NA
Vyasi P/H	NA	29.09.23 06:25	29.09.23 09:53	GRP, 86A/86B optd., Zone-2 E/F trip, F.L: 47.48 KM		116.79 A 45 MW (E)	Ia= 114.0A Ib= 117.5 A Ic= 118.3 A	NA
220KV S/S Jhajhra	GE Multilin e D-60/Alstom P442	29.09.23	29.09.23	No tripping observed		149 A 54 MW (E)		NA
Khodri P/H	GE Multilin e D-60/Alstom P442	29.09.23 06:25	29.09.23 07:24	Dir. O/C & E/F prot. Optd., 86A/86B optd. Main-2: Dist. Optd., fault in Zone-2, Active geroup-1, std. phase-Bn, Std. element Dist., E/F	NA	52 MW	Ia= 243.01A Ib= 1.987 KA Ic= 402.7 A Van=126.7 KV Vbn=91.4	NA

NAME OF SUBSTATION	TYPE OF RELAY	TRIPPING DATE/TIME	CLOSING DATE/TIME	FLAGS & INDICATION OBSERVED	ANALYSIS WITH DISCREPENCY IN FLAGS	PRE-FAULT Load	POST FAULT	REMARK
				start in 1, F.D: 76.89ms, R.T.T: 00.0s, F.L: 66.57km			0 KV Vcn=125. 2 KV	
220KV S/S Jhajhra	GE Multilin e D-60/Alstom P442	30.09.23 / 12:56	30.09.23/ 16:14	General alarm, cos alarm, Active group-1, Start phase CN, Tripped phase ABC, Start element Dist., E/F start In 1, Dist. Trip Z1, F.D:79.95ms, R.T.T:79.95ms, F.L: 6.156KM, F.R:11.18ohm, Fault in Z1	During line patrolling fault was not found	402 A 145 MW	Ia=368.3 A Ib=341.2 A Ic=6.725 KA Van= 127.9KV Vbn=125.6KV Vcn= 87.41KV	NA
Khodri P/H	GE Multilin e D-60/Alstom P442	30.09.23 12:56	30.09.23/ 16:14	Dir. O/C & E/F prot. Optd. Main-2: Dist. Prot. Optd., fault in Zone-3, F.D: 131.6ms, F.L: 26.35km, F.R: 35.04ohm, 86A/86B optd.		139 MW (I)	Ia=378A Ib= 339.9A Ic=1.690 KA Van= 121.4KV Vbn=123.7KV Vcn= 95.06KV	NA
220KV S/S Jhajhra	GE Multilin e D-60/F650	11.10.23 / 13:56	11.10.23/ 16:42	Fault type AG, GND Dist. Z1, N/G, F.L:8.9km	Line was tripped due to kite coming on tower no. 82	16 A 03 MW 02 MVR (Imp.)	Ia=7177.3 86A Ib=57.486 A Ic=82.986 A Ig=7313.8 73	NA

NAME OF SUBSTATION	TYPE OF RELAY	TRIPPING DATE/TIME	CLOSING DATE/TIME	FLAGS & INDICATION OBSERVED	ANALYSIS WITH DISCREPENCY IN FLAGS	PRE-FAULT Load	POST FAULT	REMARK
Kulhal P/H	GE Multilin e D-60/F650	11.10.23 13:55	11.10.23/ 16:42	Dist. prot. optd., Main dist. relay trip other phase A, N/G, CB Open, 86 optd.		21Amp 2 MW - 4MVR (Exp.)	NA	NA
220KV S/S Jhajhra	GE Multilin e D-60/F650	19.10.23 / 13:26	19.10.23/ 13:59	GND Dist. Z2, 86 optd, F.L: 26.7km	Patrolling done by O&M team but fault not fount	20A 04MW 03 MVR (Imp.)	Ia=3.45kA Ib=3.44kA Ic=0A Ig=0	NA
Kulhal P/H	GE Multilin e D-60/F650	19.10.23 13:28	19.10.23/ 14:01	Dist. prot. optd., Main dist. relay trip other, phase A, phase B, phase dist. Z1 optd.		29Amp 4 MW - 4MVR (Exp.)	NA	NA
220KV S/S Jhajhra	GE Multilin e D-60/F650	19.10.23 / 13:26	19.10.23/ 13:58	GND Dist. Z1 optd.	Patrolling done by O&M team but fault not fount	38 A 08MW 05 MVR (Imp.)	Ia=2.77kA Ib=1.4kA Ic=21A Ig=1.355kA	NA
Dhalipur P/H	GE Multilin e D-60/F650	19.10.23	19.10.23	No tripping observed		NA	NA	NA
220KV S/S Jhajhra	GE Multilin e D-60/F650	25.10.23 / 09:28	25.10.23/ 11:45	Active Group-1, fault type AG, GND Dist. Z1, F.L: 10.2km	the line trip due to the laying of cable by a labour	152A 33MW 09 MVR (Exp.)	Ia=142.477A Ib=191.974A Ic=8031.142A In=7863.928A	NA
132KV S/S Purkul	micome P545/micome P143	25.10.23 / 09:28	25.10.23/ 11:47	86T, 86T, 86T, 186, B-phase trip, active group-1, std. phase CN,		156Amp 33.9 MW	Ia=146.5A Ib=186.5A	NA

NAME OF SUBSTATION	TYPE OF RELAY	TRIPPING DATE/TIME	CLOSING DATE/TIME	FLAGS & INDICATION OBSERVED	ANALYSIS WITH DISCREPENCY IN FLAGS	PRE-FAULT Load	POST FAULT	REMARK
				tripped phase C, std. element dist. O/C std. I>1, E/F std. IN1, dist. trip Z1, F.D: 71.64ms, R.T.T: 79.97ms, F.L: 11.39km, F.R: 9.304ohm, fault in Zone 1		9.2MV R (imp.)	Ic=1.581 KA Van=73.9 6kv Vbn=73.8 6kv Vcn=24.7 kv	
220KV S/S Jhajhara	GE Multilin e D-60/Alstom P442	04.11.23 /11:14	04.11.23/ 18:50	Std. phase BCN, tripped phase ABC, tripped Zone-2, F.D: 463.1ms, R.T.T: 79.96ms, F.L: 25.13KM, F.R: 106.9 ohm, 86A, 86B	During patrolling it was found that	347 A 117 MW 58 MVR (Exp.)	Ia=545.8 A Ib=4.563 KA Ic=428.5 A Van= 124.6KV Vbn=81.3 9KV Vcn= 125.8KV	NA
Khodri P/H	GE Multilin e D-60/Alstom P442	04.11.23 11:15	04.11.23/ 18:52	Main-1 Dist. Prot. Optd., Dir. O/C & E/F prot. Optd., Main-2 dist. Prot. Optd. 86A & 86B optd. Backup dist. Prot. Relay- Earth fault start IN-1, trip phase ABC, Dist. Trip Z-1, F.D: 81.64ms, R.T.T: 113.3ms, F.L: 1.502KM, F.R: 4950-ohm, Fault in Zone -1	220kv jhajhara-khodri line was tripped due to breakage of Y phase jumper at tower no. -06	98 MW 45 MVR (Imp.)	Ia=573A Ib=5.262 KA Ic=448.8 A Van=134. 3KV Vbn=26.0 7KV Vcn=132. 4KV	NA

## 5.0. Observations and Recommendations

### 5.1. Reporting of all the Tripping with DR/EL

- a. For the interstate lines, as per IEGC clause 37.2(c) and clause 15.3 of CEA grid standard, all the DR/EL reports shall be uploaded on Web Based Tripping Monitoring System “http://103.7.128.184/Account/Login.aspx” within 24 hours of the events. These are being submitted by sub-station to NRLDC portal, however the record of the same is not kept at substation level.

Status of submission of FIR/DR/EL/Tripping Report on NR Tripping Portal																	
Time Period: 1st January 2024 - 31st January 2024																	
S. No.	Utility	Total No. of tripping	First Information Report (Not Received)		Disturbance Recorder (Not Received)		Disturbance Recorder (NA) as informed by utility		Event Logger (Not Received)		Event Logger (NA) as informed by utility		Tripping Report (Not Received)		Tripping Report (NA) as informed by utility	Tripping Report (Not Received)	Remark
			Value	%	Value	%	Value	%	Value	%	Value	%					
36	SLDC-PS	29	2	7	13	6	57	13	5	54	16	0	55				
37	SLDC-RS	130	12	9	23	11	19	23	9	19	35	0	30				DR, EL & Tripping report need to be submitted
38	SLDC-LIK	6	0	0	0	4	0	0	4	0	1	3	33				
39	SLDC-UP	80	10	13	11	9	15	12	10	17	11	1	14				
40	STERLITE	1	0	0	0	0	0	0	0	0	0	1	0				Details received
41	TANAKPUR-NH	4	1	25	1	0	25	1	0	25	1	0	25				DR, EL & Tripping report need to be submitted
42	JINCHAHAR-NT	1	0	0	0	0	0	0	1	0	0	0	0				Details received
Total in NR Region		520	147	28	169	69	37	171	70	38	385	17	37				

*As per the IEGC provision under clause 37.2 (c), detailed tripping report along with DR & EL has to be furnished within 24 hrs of the occurrence of the event*

Ref: NRPC 216 OCC Agenda (Annexure B.VIII)

- b. For the tripping of intra-state lines, the brief tripping reports are submitted to Divisional office. The DR/EL reports are downloaded by respective officials and forwarded, as per need basis. The record of these DR/EL is not kept at sub-stations
- c. It is recommended that each sub-station to have a central repository of such tripping reports, along with DR/EL reports and analysis. A dedicated PC can be kept for this.

### 5.2. Development of centralized database of relay settings

- a. In 48th TCC & 70th NRPC Meeting (held on 17-18 Nov 2023), NRPC Committee has approved for development of a portal through PSDF for Centralized database containing details of relay settings for grid elements connected to 220 kV and above. Portal shall have other features including protection setting calculation tool. A nodal officer shall be providing this data at central portal.
- b. The relay settings for below 220kV are to be calculated by SLDC and/or central level. The relays are tested by sub-station officials as per need basis, but the record of recommended

settings/ calculation is not kept at sub-station level. This makes it difficult to validate the settings and test results, in case of relay testing.

- c. It is recommended that latest recommended relay settings, as decided by RLDC for 220kV & above and by SLDC below 220kV along with setting calculations & parameters used for all the relays be kept at sub-station level. This will help in proper fault analysis and ascertaining relay healthiness.

### **5.3. *Review of test results of relay and equipment***

- a. Testing of most of the equipment is carried out, as per availability of shut-down and testing equipment. After testing, the test records are summarily recorded in testing register, with remarks as “tested. OK”.
- b. For the numeric relay testing, the testing is carried out by supplier at the time of installation and subsequently as per need basis, including at the time of change in settings.
- c. A draft O&M manual is available at PTCUL web-site, which includes various tests and their frequency, along with results. This manual is based on CERC/SERC regulations of 2004-2008. It is recommended that this manual may be updated and implemented and record of test values may be kept for future reference.

### **5.4. *Availability of Testing Kits***

- a. The availability of testing equipment is limited at each sub-station is limited. For comprehensive testing of equipment, as per above para, sufficient testing kits at each sub-station/Sub-division/Division level are required.
- b. It is recommended that based on approved O&M manual, station, Sub-division, Division wise testing instruments be arranged for regular testing of equipment.

### **5.5. *Up-dation of PTCUL Protection Philosophy***

The protection philosophy adopted by Utility, in general, is in alignment with protection philosophy adopted by NRPC. As the NRPC has recently updated the protection philosophy, PTCUL in consultation with SLDC may update protection philosophy for network not covered by NRPC, if needed, and implement the same.

### **5.6. *Simulation based study of protection system***

As per IEGC, protection code, during audit the relay settings to be adopted shall be validated with simulation based or EMTP studies and details shall be enclosed in report. The current scope of audit was excluding these studies, therefore, Simulation based or EMTP Studies should be carried out by the Utility, as per the requirement of Grid Code.

### **5.7. *Capacity Building of protection team***

During the discussions with officials at site, it was observed that the teams responsible for the protection system and SAS, needs to be updated on current trends on protection system, communication schemes and Sub-station automation. Utility may undertake capacity building exercise for the officials involved in these activities.

### **5.8. *Updated Fault Level/ Short Circuit Level and Network information***

The fault level/ short circuit level for each substation is being calculated at central level. Such studies are carried out, as and when new elements are added in the network. This has impact on relay settings parameters and equipment ratings. It is recommended that the updated network information and short circuit level be maintained at central level for revising the setting as per requirement.

### **5.9. *General Protection related observations***

The study of Fire protection system/ Nitrogen Injection Fire Protection System, Lightning Protection system, Earthing Mat/ Earthing Protection are not covered under protection audit. Utility may get a comprehensive technical and safety audit carried out internally or thru third party and corrective action for any discrepancy be taken up accordingly.

### **5.10. *O&M Manual***

The Utility has a draft O&M manual uploaded on its website, which is being referred by working level officials as a guideline for regular O&M and testing functions. This manual needs to be updated to incorporate recent developments and approved for regular use in all sub-stations to bring uniformity in O&M and testing practices across the utility.



## 6.0. Station Specific Observation and Recommendations

### 6.1. Protection related observations and recommendations

6.1.1. The sub-station is well kept:

- a. All the records of SLD, protection setting, equipment testing and tripping is well kept.
- b. The sub-station is fully operated thru SAS system.
- c. The events are recorded from individual relays, no separate Event Logger is provided. All relays are centrally connected for downloading the DR and EL.
- d. Both the 220V DC systems are replaced recently.

6.1.2. Based on analysis of line tripping during last 12 months, following were observed:

- a. Most of the feeders are passing thru urban area/ forest area and trippings are happening due to encroachment of line clearance by kite, birds and construction near transmission lines. Protection system is found to be working ok during these cases.
- b. During this period 220kV Vyasi- Jhajhra line tripped 14 times, out of which 10 times it was due to over voltage on remote side. The remote end is a generating station, relay co-ordination and setting at remote end need to be updated as per latest NRPC guidelines.
- c. During this period 2 nos. tripping from remote end on zone 2 was observed for 220kV khodri line from remote. The remote end is a generating station, relay co-ordination and setting at remote end need to be updated as per latest NRPC guidelines.
- d. On 30/05/2023, 23/7/2023 and 27/8/2023 multiple LV side of transformers tripped due to fault on 33kV system. The 33kV system beyond the 33kV side of transformers is owned by distribution company, i.e. UPCL. Any fault in 33kV and/or 11kV, if not cleared in time, can cause tripping of LV side of transformer, as the non-directional Over current and Earth Fault protection is provided.
- e. On 17/5/2023 220kV bus-coupler tripped on over current, due to unbalanced load. Setting modified by utility.

6.1.3. Bus Bar Protection on 220kV Bus is not functional. Protection is commissioned, but due to non-availability of shut-down, stability test could not be carried out. Utility had informed that expected date for putting in service is 31.03.2024. Status to be updated. If not commissioned so far, to be carried out ASAP.

6.1.4. PLCC aided protection is not functional on important transmission lines. It is recommended to be taken up on priority:

- j. 220kV Khodri line PLCC protection not operational due to issue at other end.

- k. 220kV IIP line PLCC protection is not functional, as protection coupler is not commissioned.

## **6.2. *Equipment related observations and recommendations***

Many of the equipment are recently replaced. Any requirement of equipment and spares may be reviewed by PTCUL.

In addition, it is recommended that sufficient quantity of maintenance equipments be made available at sites. A suggested list of Maintenance Equipment is attached at Annexure – 3.

## **6.3. *Auxiliary Equipment related observations and recommendations***

- a. The 220V DC system is configured for single Source DC. Therefore, both the DC sources are connected thru changeover relays at individual bay level to maintain redundancy. In case of delay in switchover, relays may shutdown and start rebooting. It is suggested that a comprehensive review of this philosophy and DC distribution system may be carried out.
- b. The 2<sup>nd</sup> Auxiliary supply source is from 220/132/33 kV transformer tertiary is not in use currently. A 2<sup>nd</sup> station transformer is connected to 33kV bus for, which is under commissioning. This needs to be expedited.

## Annexure – 1: Suggested List of Testing Instruments

CBIP suggests the following list of testing instruments based on the approved O&M manual

Sl. No.	Testing Instruments
1	DCRM for Circuit Breaker
2	DC Earth Fault Locator
3	SF6 Gas Density Monitor
4	SF6 Gas Leakage detector/ Imaging Camera
5	CB Analyser
6	Earth Resistance Tester
7	Portable Digital Selective Level Meter cum Level Generator
8	Selective Level Generator
9	LA Leakage Current Analyser
10	Digital Multi-meter
11	Tong Tester
12	Tan Delta Test Kit
13	Digital Leakage Clamp Meter
14	Phase Sequence Indicator
15	Megger (5 kV)
16	Digital Capacitance Meter
17	CT Polarity Tester
18	PT Test Set

## Annexure – 2: Suggested List of Substation Equipments

The suggested list of Substation Equipments keeping in mind the necessity for the modernization and upgradation of substations.

Sl. No.	Equipment	Unit	Quantity
<b>A</b>	<b>220 kV Equipment</b>		
<b>1</b>	245 kV. 1600A,40KA, (3 Phase) HDB Isolator with one E/s (Metallic & Insulator)	Nos	14
<b>2</b>	245 kV. 2500A,40KA, (3 Phase) HDB Isolator with two E/s (Metallic & Insulator)	Nos	7
<b>3</b>	245 kV. 1600A,40KA, (3 Phase) HDB tandem Isolator (Metallic & Insulator)	Nos	20
<b>4</b>	245 kV Current Transformer (5 Core), Class 0.2s (1ph), 1600/800/1, (Protection Core)800/400/1 (metering Core)	Nos	15
<b>5</b>	242 kV Current Transformer (5 Core), Class 0.2 (1ph) 600/400/1	Nos	6
<b>6</b>	243 kV Current Transformer (5 Core), Class 0.2 (1ph) 400/200/1	Nos	6
<b>7</b>	244 kV Current Transformer (5 Core), Class 0.2 (1ph) 150/50/1	Nos	3
<b>8</b>	245 kV Bus PT	Nos	6
<b>9</b>	245 kV CVT 1 Ph	Nos	6
<b>10</b>	216 kV Surge Arrestor 1Ph	Nos	6
<b>B</b>	<b>132 kV Equipment</b>		
<b>1</b>	145 kV Circuit Breaker 3PH	Nos	8
<b>2</b>	145 kV. 1250A, (3 Phase) HDB Isolator without E/s (Metallic & Insulator)	Nos	7
<b>3</b>	145 kV. 1250A, (3 Phase) HDB Isolator with one E/s (Metallic & Insulator)	Nos	8

Sl. No.	Equipment	Unit	Quantity
4	145 kV. 1250A, (3 Phase) HDB Tandem Isolator (Metallic & Insulator)	Nos	7
5	145 kV Current Transformer 1Ph (5 Core), Class 0.2s (1ph) 800/400/1	Nos	12
6	145 kV Current Transformer 1Ph (5 Core), Class 0.2s (1ph) 1200/800/1	Nos	6
7	145 kV Current Transformer 1Ph (5 Core), Class 0.2s (1ph) 200/100/1	Nos	3
8	145 kV PT	Nos	6
9	132 kV Surge Arrestor 1Ph (polymer)	Nos	15
<b>C</b>	<b>33kV Equipment</b>		
1	33 kV Circuit Breaker	Nos	15
2	33 kV Isolator 3Ph with earth switch (800 Amp)	Nos	12
3	33 kV Isolator 3Ph with earth switch (1600 Amp)	Nos	3
4	33 kV Isolator 3Ph without earth switch (800 Amp)	Nos	24
5	33 kV Isolator 3Ph without earth switch (1600 Amp)	Nos	5
6	33 kV Current Transformer (3 Core), Class 0.2s (1ph) 1600/800/1	Nos	6
7	33 kV Current Transformer (3 Core), Class 0.2s (1ph) 800/400/1	Nos	36
8	33 kV PT	Nos	6

### Annexure – 3: Suggested List of Maintenance Equipments

Sl. No.	Equipment
1	Oil Filter Machine
2	SF6 Gas Handling Plant
3	SF6 Gas Density Monitor
4	Thermo-Vision Camera Lines and Sub-Station
5	Binocular Vision Camera
6	SF6 Gas Leakage Imaging Camera
7	LA Leakage Current Analyser
8	Online DGA
9	Oil BDV Kit
10	Hydraulic Crimping Tool for different Types of ACSR Conductor
11	Hydraulic Conductor Cutter
12	Fork Lift 5 Ton Capacity
13	Digital Leakage Clamp Meter

A mobile van with test kits can be kept for optimizing the resources at various substations

## Annexure – 4: Protection Code (IEGC 2023 Chapter 4)

- **General**

1. This chapter covers the protection protocol, protection settings and protection audit plan of electrical systems.
2. There shall be a uniform protection protocol for the users of the grid:
  - a) for proper co-ordination of protection system in order to protect the equipment/system from abnormal operating conditions, isolate the faulty equipment and avoid unintended operation of protection system;
  - b) to have a repository of protection system, settings and events at regional level;
  - c) specifying timelines for submission of data;
  - d) to ensure healthiness of recording equipment including triggering criteria and time synchronization; and
  - e) to provide for periodic audit of protection system.

- **Protection protocol**

1. All users connected to the integrated grid shall provide and maintain effective protection system having reliability, selectivity, speed and sensitivity to isolate faulty section and protect element(s) as per the CEA Technical Standards for Construction, the CEA Technical Standards for Connectivity, the CEA (Grid Standards) Regulations, 2010, the CEA Technical Standards for Communication and any other applicable CEA Standards specified from time to time.
2. Back-up protection system shall be provided to protect an element in the event of failure of the primary protection system.
3. RPC shall develop the protection protocol and revise the same, after review from time to time, in consultation with the stakeholders in the concerned region, and in doing so shall be guided by the principle that minimum electrical protection functions for equipment connected with the grid shall be provided as per the CEA Technical Standards for Construction, the CEA Technical Standards for Connectivity, the CEA Technical Standards for Communication, the CEA (Grid Standards) Regulations, 2010, the CEA (Measures

relating to Safety and Electric Supply) Regulations, 2010, and any other CEA standards specified from time to time.

4. The protection protocol in a particular system may vary depending upon operational experience. Changes in protection protocol, as and when required, shall be carried out after deliberation and approval of the concerned RPC.
5. Violation of the protection protocol of the region shall be brought to the notice of concerned RPC by the concerned RLDC or SLDC, as the case may be.

- **Protection settings**

1. RPCs shall undertake review of the protection settings, assess the requirement of revisions in protection settings and revise protection settings in consultation with the stakeholders of the respective region, from time to time and at least once in a year. The necessary studies in this regard shall be carried out by the respective RPCs. The data including base case (peak and off-peak cases) files for carrying out studies shall be provided by RLDC and CTU to the RPCs:
2. All users connected to the grid shall:
  - a) furnish the protection settings implemented for each element to respective RPC in a format as prescribed by the concerned RPC;
  - b) obtain approval of the concerned RPC for,
    - i. any revision in settings, and,
    - ii. implementation of new protection system;
  - c) intimate to the concerned RPC about the changes implemented in protection system or protection settings within a fortnight of such changes;
  - d) ensure correct and appropriate settings of protection as specified by the concerned RPC.
  - e) ensure proper coordinated protection settings.
3. RPCs shall:
  - a) maintain a centralized database and update the same on periodic basis in respect of their respective region containing details of relay settings for grid elements connected to 220 KV and above (132 KV and above in NER). RLDCs shall also maintain such database.



- b) carry out detailed system studies, once a year, for protection settings and advise modifications / changes, if any, to the CTU and to all users and STUs of their respective regions. The data required to carry out such studies shall be provided by RLDCs and CTU.
  - c) provide the database access to CTU and NLDC and to all users, RLDC, SLDCs, and STUs of the respective regions. The database shall have different access rights for different users.
4. The changes in the network and protection settings of grid elements connected to 220KV and above (132 KV and above in NER) shall be informed to RPCs by CTU and STUs, as the case may be.

The elements of network below 66KV and radial in nature which do not impact the National Grid may be excluded as finalized by the respective RPC.

- **Protection audit plan**

1. All users shall conduct internal audit of their protection systems annually, and any shortcomings identified shall be rectified and informed to their respective RPC. The audit report along with action plan for rectification of deficiencies detected, if any, shall be shared with respective RPC for users connected at 220 KV and above (132 KV and above in NER).
2. All users shall also conduct third party protection audit of each substation at 220 KV and above (132 KV and above in NER) once in five years or earlier as advised by the respective RPC.
3. After analysis of any event, each RPC shall identify a list of substations / and generating stations where third-party protection audit is required to be carried out and accordingly advise the respective users to complete third party audit within three months.
4. The third-party protection audit report shall contain information sought in the format enclosed as Annexure–1. The protection audit reports, along with action plan for rectification of deficiencies detected, if any, shall be submitted to the respective RPC and RLDC or SLDC, as the case may be, within a month of submission of third-party audit report. The necessary compliance to such protection audit report shall be followed up regularly in the respective RPC.

5. Annual audit plan for the next financial year shall be submitted by the users to their respective RPC by 31<sup>st</sup> October. The users shall adhere to the annual audit plan and report compliance of the same to their respective RPC.
6. Users shall submit the following protection performance indices of previous month to their respective RPC and RLDC on monthly basis for 220 KV and above (132 KV and above in NER) system, which shall be reviewed by the RPC:
  - c. The Dependability Index defined as

$$D = \frac{N_c}{N_c + N_f}$$

where,

$N_c$  is the number of correct operations at internal power system faults and

$N_f$  is the number of failures to operate at internal power system faults.

- d. The Security Index defined as

$$S = \frac{N_c}{N_c + N_u}$$

where,

$N_c$  is the number of correct operations at internal power system faults

$N_u$  is the number of unwanted operations.

- e. The Reliability Index defined as

$$R = \frac{N_c}{N_c + N_i}$$

where,

$N_c$  is the number of correct operations at internal power system faults

$N_i$  is the number of incorrect operations and is the sum of  $N_f$  and  $N_u$

7. Each user shall also submit the reasons for performance indices less than unity of individual element wise protection system to the respective RPC and action plan for corrective measures. The action plan will be followed up regularly in the respective RPC.
8. In case any user fails to comply with the protection protocol specified by the RPC or fails to undertake remedial action identified by the RPC within the specified timelines, the concerned RPC may approach the Commission with all relevant details for suitable directions.

- **System Protection Scheme (SPS)**

1. SPS for identified system shall have redundancies in measurement of input signals and communication paths involved up to the last mile to ensure security and dependability.
2. For the operational SPS, RLDC or NLDC, as the case may be, in consultation with the concerned RPC(s) shall perform regular load flow and dynamic studies and mock testing for reviewing SPS parameters & functions, at least once in a year.
3. RLDC or NLDC shall share the report of such studies and mock testing including any short comings to respective RPC(s). The data for such studies shall be provided by CTU to the concerned RPC, RLDC and NLDC.
4. The users and SLDCs shall report about the operation of SPS immediately and detailed report shall be submitted within three days of operation to the concerned RPC and RLDC in the format specified by the respective RPCs.
5. The performance of SPS shall be assessed as per the protection performance indices specified in these Regulations. In case, the SPS fails to operate, the concerned User shall take corrective actions and submit a detailed report on the corrective actions taken to the concerned RPC within a fortnight.

- **Recording instruments**

1. All users shall keep the recording instruments (disturbance recorder and event logger) in proper working condition.

2. The disturbance recorders shall have time synchronization and a standard format for recording analogue and digital signals which shall be included in the guidelines issued by the respective RPCs.
3. The time synchronization of the disturbance recorders shall be corroborated with the PMU data or SCADA event loggers by the respective RLDC. Disturbance recorders which are non-compliant shall be listed out for discussion at RPC.

## **Annexure – 5: Third Party Protection System Checking & Validation Template for a Substation (IEGC 2023 Annexure – 1)**

### **1. Introduction:**

- a. The audit reports, along with action plan for rectification of deficiencies found, if any, shall be submitted to RPC or RLDC within a month of submission of report by auditor.
- b. The third-party protection system checking shall be carried at site by the designated agency. The agency shall furnish two reports:
  - i. Preliminary Report: This report shall be prepared on the site and shall be signed by all the parties present.
  - ii. Detailed Report: This report shall be furnished by agency within one month after carrying out detailed analysis.

### **2. Checklist:**

- a. The protection system checklist shall contain information as per this Regulation.
  - i. General Information (to be provided prior to the checking as well as to be included in final report):
    - Substation name
    - Name of Owner Utility
    - Voltage Level (s) or highest voltage level
    - Short circuit current rating of all equipment (for all voltage level) (v) Date of commissioning of the substation
    - Checking and validation date
    - Record of previous tripping's (in last one year) and details of protection operation
    - Previous Relay Test Reports
    - Overall single line diagram (SLD) (x) AC aux SLD
    - DC aux SLD
    - SAS architecture diagram
    - SPS scheme implemented (if any)

b. The preliminary report shall inter-alia contain the following:

**FORMAT OF PRELIMINARY REPORT**

S. No.	Issues	Remarks
<b>1</b>	<b>Recommendation of last protection checking and validation</b>	Status of works & pending issues if any
<b>2</b>	<b>Review of existing settings at substation</b>	Recommended Action
<b>3</b>	<b>Disturbance Recorder out/ available for last 6 trippings (Y/N)</b>	Recommended Action
<b>4</b>	<b>Chronic reason of tripping, if any</b>	Recommended Action
<b>5</b>	<b>Major non-conformity/deficiency observed</b>	Recommended Action

c. The **relay configuration check-list** for available power system elements at station:

- Transmission Line
- Bus Reactor/Line Reactor
- Inter-connecting Transformer
- Busbar Protection Relay
- AC auxiliary system
- DC auxiliary system
- Communication system
- Circuit Breaker Details
- Current Transformer details
- Capacitive Voltage Transformers Details
- Any other equipment/system relevant for protection system operation

d. The **minimum set of points on which checking & validation** shall be carried out is covered in this clause. The detailed list shall be prepared by checking and validation team in consultation with concerned entity, RLDC and RPC.

**i. Transmission Line Distance Protection/Differential Protection;**

- Name and Length of Line
- Whether series compensated or not

- Mode of communication used (PLCC/OPGW)
- Relay Make and Model for Main-I and Main-II
- List of all active protections & settings
- Carrier aided scheme if any
- Status of Power Swing/Out of Step/SOTF/Breaker Failure/Broken Conductor/STUB/Fault Locator/DR/VT fuse fail/Overvoltage Protection/Trip Circuit supervision/Auto-reclose/Load encroachment etc.
- Relay connected to Trip Coil-1 or 2 or both i. CT ratio and PT ratio
- Feed from DC supply-1 or 2
- Connected to dedicated CT core (mention name)
- Other requirements for protection checking and validation

**ii. Shunt Reactor & Inter-connecting Transformer (ICT) Protection;**

- Whether two groups of protections used (Group A and Group B)
- Do the groups have separate DC sources
- Relay Make and Model
- List of all active protections along with settings
- Status of Differential Protection/Restricted Earth Fault Protection/Back-up Directional Overcurrent/Backup Earth fault/ Breaker Failure
- Status of Oil Temperature Indicator/Winding-Temperature Indicator/Bucholz/Pressure Release Device etc.
- Relay connected to Trip Coil-1 or 2 or both
- CT ratio and PT ratio
- Feed from DC supply-1 or 2
- Connected to dedicated CT core (mention name)
- Other requirements for protection checking and validation

**iii. Busbar Protection Relay;**

- Busbar and redundant relay make and model
- Type of Busbar arrangement
- Zones
- Dedicated CT core for each busbar protection (Yes/No)
- Breaker Failure relay included (Yes/No), if additional then furnish make and model

- Trip issued to both Busbar protection in case of enabling
- Isolator indication and check relays
- Other requirements for protection checking and validation

**iv. AC auxiliary system;**

- Source of AC auxiliary system
- Supply changeover between sources (Auto/Manual)
- Diesel generator (DG) details
- Maintenance plan and supply changeover periodicity in DG
- Single Line Diagram
- Other requirements for protection checking and validation

**v. DC auxiliary system;**

- Type of Batteries (Make, vintage, model)
- Status of battery Charger
- Measured voltage (positive to earth and negative to earth)
- Availability of ground fault detectors
- Protection relays and trip circuits with independent DC sources
- Other requirements for protection checking and validation
- Communication system
  - Mode of communication for Main-1 and Main-2 protection
  - Mode of communication for data and speech communication
  - Status of PLCC channels
  - Time synchronization equipment details
  - 7OPGW on geographically diversified paths for Main-1 and main-2 relay
  - Other requirements for protection checking and validation

**vi. Circuit Breaker Details;**

- Details and Status
- Healthiness of Tripping Coil and Trip circuit supervision relay
- Single Pole/Multi pole operation
- Pole Discrepancy Relay available (Y/N)
- Monitoring Devices for checking the dielectric medium



- Other requirements for protection checking and validation
- Current Transformer (CT)/Capacitive Voltage Transformer (CVT) Details
  - CT/CVT ID name and voltage level
  - CT/CVT core connection details
  - Accuracy Class
  - Whether Protection/Metering
  - CT/CVT ratio available and ratio adopted
  - Details of last checking and validation of CT/CVT healthiness
  - Other requirements for protection checking and validation
  - Other protections: Direction earth fault, negative sequence, over current, over voltage, over frequency, under voltage, under frequency, forward power, reverse power, out of step/power swing, HVDC protection etc.

### 3. Summary of checking:

The summary shall specifically mention minimum following points:

- a) The settings and scheme adopted are in line with agreed protection philosophy or any accepted guidelines (e.g. Ramakrishna guidelines or CBIP manual based).
- b) The deviations from the RPC protection philosophy, if any and reasons for taking the deviations shall be recorded.
- c) All the major general deficiency shall be listed in detail along with remedial recommendations.
- d) The relay settings to be adopted shall be validated with simulation based or EMTP studies and details shall be enclosed in report.
- e) The cases of protection maloperation shall be analysed from protection indices report furnished by concerned utility, the causes of failure along with corrective actions and recommendations based on the findings shall be noted in the report.

## Annexure – 6: Protection Philosophy/Protocol of Northern Region

The Protection Philosophy/Protocol of Northern Region is developed in compliance of IEGC 2023, Version 2.0 which was approved in 71<sup>st</sup> NRPC meeting held on 29.01.2024.

S.N.	Protection Setting/Protocol	Mandated Setting for transmission lines
1	<b>Protection Scheme</b>	<p>220KV and above: Independent Main-I and Main-II protection (of different make OR different type/different algorithm) of non-switched numerical type is to be provided with carrier aided scheme.</p> <p>132KV and below: One non-switched distance protection scheme and, directional over current and earth fault relays, should be provided as back up.</p>
2	<b>Distance Protection Zone-1</b>	<p>Reach: 80% of the protected line; 110% of the protected line (In case of radial lines) Time Setting: Instantaneous.</p>
3	<b>Distance Protection Zone-2</b>	<p>Reach: Single Circuit Line: 120% of length of principle line section. Double circuit line: 150% coverage of line to take care of under reaching due to mutual coupling effect.</p> <p>Time setting: i. 0.35 second <i>(considering LBB time of 200mSec, CB open time of 60ms, resetting time of 30ms and safety margin of 60ms)</i> ii. 0.5-0.6 second <i>(For a long line followed by a short line)</i></p>

S.N.	Protection Setting/Protocol	Mandated Setting for transmission lines
4	<b>Distance Protection Zone-3</b>	<p>Reach: Zone-3 should overreach the remote terminal of the longest adjacent line by an acceptable margin (typically 20% of highest impedance seen) for all fault conditions.</p> <p>Time Setting: 800-1000 msec</p> <p>If zone-3 reach transcends to other voltage level, time may be taken up to 1.5 sec.</p>
5	<b>Distance Protection Zone- 4</b>	<p>The Zone-4 reverse reach must adequately cover expected levels of apparent bus bar fault resistance. Time may be coordinated accordingly.</p> <p>Where Bus Bar protection is not available, time setting: 160 msec.</p>
6	<b>Lines with Series and other compensations in the vicinity of Substation</b>	<ul style="list-style-type: none"> <li>• Zone-1: FSC end: 60% of the protected line. Time: Instantaneous; Remoted end: 60% of the protected line with 100ms-time delay. POR Communication scheme logic is modified such that relay trips instantaneously in Zone-1 on carrier receive.</li> <li>• Zone-2: 120 % of uncompensated line impedance for single circuit line. For Double circuit line, settings may be decided on basis of dynamic study in view of zero sequence mutual coupling.</li> <li>• Phase locked voltage memory is used to cope with the voltage inversion. Alternatively, an intentional time delay may be applied to overcome directionality problems related to voltage inversion.</li> <li>• Over-voltage stage-I setting for series</li> </ul>

S.N.	Protection Setting/Protocol	Mandated Setting for transmission lines
		compensated double circuit lines may be kept higher at 113%.
7	<b>Power Swing Blocking</b>	<ul style="list-style-type: none"> <li>Block tripping in all zones, all lines.</li> </ul> Out of Step tripping to be applied on all inter-regional tie lines. Deblock time delay = 2s
8	<b>Protection for broken conductor</b>	Negative Sequence current to Positive Sequence current ratio more than 0.2 (i.e. $I_2/I_1 \geq 0.2$ ) Alarm Time delay: 3-20 sec. Tripping may be considered for radial lines to protect single phasing of transformers.
9	<b>Switch on to fault (SOTF)</b>	Switch on to fault (SOTF) function to be provided in distance relay to take care of line energization on fault.
10	<b>VT fuse fail detection function</b>	VT fuse fail detection function shall be correctly set to block the distance function operation on VT fuse failure.
11	<b>Carrier Protection</b>	To be applied on all 220KV and above lines with the only exception of radial feeders.
12	<b>Back up Protection</b>	1. On 220KV and above lines with 2 Main Protections: <ul style="list-style-type: none"> <li>Back up Earth Fault protections alone to be provided.</li> <li>No Over current protection to be applied.</li> </ul> 2. At 132KV and below lines with only one Main protection: <ul style="list-style-type: none"> <li>Back up protection by IDMT O/C and E/F to be applied.</li> </ul>

S.N.	Protection Setting/Protocol	Mandated Setting for transmission lines
13	<b>Auto Reclosing with dead time.</b>	<p>AR shall be enabled for 220 KV and above lines for single pole trip and re-closing.            Dead time = 1.0s. Reclaim time = 25.0s</p> <p>Auto-recloser shall be blocked for following:</p> <ul style="list-style-type: none"> <li>• Faults in cables</li> <li>• Breaker Fail Relay</li> <li>• Line Reactor Protections</li> <li>• O/V Protection</li> <li>• Received Direct Transfer trip signals</li> <li>• Busbar Protection</li> <li>• Zone 2/3 of Distance Protection</li> <li>• Circuit Breaker Problems.</li> </ul> <p>CB Pole discrepancy relay time:1.5 sec; for tie breaker: 2.5 sec</p>
14	<b>Busbar protection</b>	To be applied on all 220KV and above sub stations with the only exception of 220KV radial fed bus bars.
15	<b>Local Breaker Backup (LBB)</b>	<p>For 220 KV and above level substations as well as generating stations switchyards, LBB shall be provided for each circuit breaker.</p> <p>LBB Current sensor I &gt; 20% In LBB time delay = 200ms</p> <p>In case of variation in CT ratio, setting may be done accordingly.</p>
16	<b>Line Differential</b>	<p>For cables and composite lines, line differential protection with built in distance back up shall be applied as Main-I protection and distance relay as Main-II protection.</p> <p>For very short line (less than 10 km), line</p>

S.N.	Protection Setting/Protocol	Mandated Setting for transmission lines
		<p>differential protection with distance protection as backup (built- in Main relay or standalone) shall be provided mandatorily as Main-I and Main-II.</p> <p>Differential protection may be done using dark fiber (preferably), or using bandwidth.</p>
17	Over Voltage Protection	<p>FOR 765KV LINES/CABLE:</p> <p>Low set stage (Stage-I): 106% - 109% (typically 108%) with a time delay of 5 seconds.</p> <p>High set stage (Stage-II): 140% - 150% with a time delay of 100 milliseconds.</p> <p>400KV LINES/CABLE:</p> <p>Low set stage (Stage-I): 110% - 112% (typically 110%) with a time delay of 5 seconds.</p> <p>High set stage (Stage-II): 140% - 150% with a time delay of 100 milliseconds.</p> <p>FOR 220 KV LINES:</p> <p>No over-voltage protection shall be used.</p> <p>FOR 220 KV CABLE:</p> <p>Low set stage (Stage-I): 110% - 112% (typically 110%) with a time delay of 5 seconds.</p> <p>High set stage (Stage-II): 140% - 150% with a time delay of 100 milliseconds.</p> <p>Drop-off to pick-up ratio of overvoltage relay: better than 97%</p>

S.N.	Protection Setting/Protocol	Mandated Setting for transmission lines
		Grading: Voltage as well as time grading may be done for multi circuit lines/cable.
18	<b>Resistive reach setting to prevent load point encroachment</b>	<p>Following criteria may be considered for deciding load point encroachment:</p> <ul style="list-style-type: none"> <li>• Maximum load current (Imax) may be considered as 1.5 times the thermal rating of the line or 1.5 times the associated bay equipment current rating (the minimum of the bay equipment individual rating) whichever is lower. (Caution: The rating considered is approximately 15minutes rating of the transmission facility).</li> <li>• Minimum voltage (V min) to be considered as 0.85pu (85%).</li> </ul>
19	<b>Direct Inter-trip</b>	<p>To be sent on operation of following:</p> <ol style="list-style-type: none"> <li>i. Overvoltage Protection</li> <li>ii. LBB Protection</li> <li>iii. Busbar Protection</li> <li>iv. Reactor Protection</li> <li>v. Manual Trip (400 KV and above)</li> <li>vi. Cable Fault (in composite lines)</li> </ol>
20	<b>Permissive Inter-trip</b>	To be sent on operation of Distance Protection

## Annexure – 7: Work Order & Corrigendum



पावर ट्रांसमिशन कारपोरेशन ऑफ उत्तराखण्ड लि०  
(उत्तराखण्ड सरकार का उपक्रम)  
अधीक्षण अभियन्ता (परीक्षण एवं परिचालन एवं स्काडा) कार्यालय  
कुमायु मण्डल हल्द्वानी  
मोबाइल नं० 9412089275, ईमेल dp\_singh@ptcul.org

No. 376 /SE (T&C)/PTCUL/ (H)/

Date:29.09.2023

Subject:- Order for Protection Audit of 02 Nos 400 kV and 08 Nos 220KV sub-stations in PTCUL.

Joint Advisor

Central Board of Irrigation and Power

Malcha Marg Chanakyapuri,

New Delhi-110021

Email: mrchauhan@cbip.org.

Dear Sir,

In reference to your offer submitted vide Ref No: P-1/CBIP/PTCUL/PTCUL/Audit/2023 dated: 11.09.2023 through email against Email enquiry dated 05.09.2023, an order is hereby placed in favour of your firm for the work of "Protection Audit of 02 Nos 400kV and 08 Nos 220 kV substations of PTCUL" The detail of material, price schedule and terms & conditions is here as under:-

Sr.No	Description	Unit	Qty	Amount	Total Amount
1	Protection Audit to be carried out for the following 10 nos of the 400/220kV substations of PTCUL :- 1. 400kV S/s Rishikesh 2. 400 kV S/s Kashipur 3. 220kV S/s Chamba 4. 220kV S/s Rishikesh 5. 220kV S/s Roorkee 6. 220kV S/s Haridwar (SIDCUL) 7. 220kV S/s Jhajra. 8. 220 kV S/s Pantnagar. 9. 220 kV S/s Haldwani. 10. 220kV S/s Mahuakheraganj.	Job	1	36,25,000	36,25,000
	<b>TOTAL</b>				36,25,000

Total value of order is Rs.36,25,000 (Rupees Thirty Six Lakh Twenty Five Thousand only ) Plus GST Extra.

End: 1. Terms & Conditions.

Please acknowledge the receipt and acceptance of order.

(D.P Singh)

Superintending Engineer (T&C), Haldwani

Date:29.09.2023

No.376 /SE (T&C)/PTCUL/ (H)/

Copy forwarded to the following for information and necessary action:-

1. Director (Operation), PTCUL, Dehradun.
2. Superintending Engineer (A) MD, PTCUL, Dehradun.
3. Chief Engineer, T&C PTCUL, 132kV Substation Campus, Kathgodam Nainital..
4. Executive Engineer, T&C Division, Kashipur.
5. Director (Energy), Central Board of Irrigation and Power Malcha Marg Chanakyapuri, New Delhi-110021 Email: [sanjeev@cbip.org](mailto:sanjeev@cbip.org)

(D.P Singh)

Superintending Engineer (T&C), Haldwani

मुख्यालय एवंपंजीकृत कार्यालय:-विद्युतमवन, नजदीक-जाई०एस०बी०टी० क्रॉसिंग, सहारनपुररोड, माजरा, देहरादून-248002  
कारपोरेटआईडी नं०: U40101UR2004GOI028675 दूरभाष नं० 0135-2646000 फैक्स नं० 0135-2643460 वेबसाइटwww.ptcul.org





पावर ट्रांसमिशन कारपोरेशन ऑफ उत्तराखण्ड लि०  
(उत्तराखण्ड सरकार का उपक्रम)  
अधीक्षण अभियन्ता (परीक्षण एवं परिचालन एवं स्काडा) कार्यालय  
कुमायु मण्डल हल्द्वानी  
मोबाइल नं० 9412089275, ईमेल dp\_singh@ptcul.org

Terms & Conditions:-

<b>1</b>	<b>Scope</b>	<p>: The detailed Scope work is as under:</p> <ol style="list-style-type: none"><li>1. There must be a kick off meeting for discussion on project plan before start of the work in field and the detailed plan of performance shall be submitted by CBIP.</li><li>2. Requisite data shall be collected in standard format from PTCUL grid substations by authorized and experienced auditor.</li><li>3. The site surveys and audit of grid substations of PTCUL shall be done by authorized and experienced auditor.</li><li>4. Review of the implemented protection schemes/philosophy for 400/220 kV substations which includes protection of transmission lines, interconnecting transformers, line/busreactors, bus bar, bus couplers etc. as per latest guidelines of Ramakrishna committee/CBIP/NRPC/International best practices. etc.</li><li>5. Review the adequacy of primary and backup protection settings for protected equipment and suggest corrective measures where ever non compliance with respect to Ramakrishna committee/ CBIP/NRPC is found during the protection audit.</li><li>6. Review of availability/healthiness of PLCC communication links used for protection systems.</li><li>7. Review the healthiness/adequacy of 220/110/50V DC system available at substations for protection application.</li><li>8. Review of availability/healthiness of GPS system and time synchronization facility used for protection.</li><li>9. Review of availability/healthiness of recording instruments like DRs /ELs for transmission lines protection.</li><li>10. Review of test reports for assessing the healthiness of circuit breakers, CT &amp; CVT based upon available test reports at sites.</li><li>11. Field inspection of protection device for obsolescence of technology, suitability and healthiness.</li><li>12. Directory of the protection system &amp; recommendation for replacement of obsolescence relays with compatible numerical relays will be provided.</li><li>13. Checking of availability of DGset/auxiliary DC supply at substations.</li><li>14. Site visits for onsite protection audit, review and inspection of substations will be performed.</li><li>15. Submission of the detailed report for the protection audit including the protection philosophy, reviewed settings and protection audit observations.</li><li>16. The performance of above protection equipment like relays, circuit breaker, CT, CVT, DC battery bank, synchro facility, communication facility used for protection will be also checked through physical inspection and provided test reports/documents. These protection equipments will be recommended for renovation and upgradation based on their performance accessed during protection audit and physical inspection.</li><li>17. Review the availability healthiness of<ul style="list-style-type: none"><li>• Event recorders/ loggers' operation history</li><li>• CT, CVT, CB</li><li>• DC power supply</li><li>• Auxiliary supply</li><li>• Communication links</li><li>• Time synchronization/ GPS</li></ul></li><li>18. Review of Testing and Maintenance records of all protective relays, Circuit Breakers CT, CVT etc. Review of protection philosophy.</li></ol>
----------	--------------	---

मुख्यालय एवंपजीकृत कार्यालय:-विद्युतमवन, नजदीक-आई०एस०बी०टी० क्रासिंग, सहारनपुररोड, माजरा, देहरादून-248002  
कारपोरेटआईडी नं०: U40101UR2004GOI028675 दूरभाष नं० 0135-2646000 फ़ैक्स नं० 0135-2643460 वेबसाइट [www.ptcul.org](http://www.ptcul.org)



पावर ट्रांसमिशन कारपोरेशन ऑफ उत्तराखण्ड लि०  
(उत्तराखण्ड सरकार का उपक्रम)  
अधीक्षण अभियन्ता (परीक्षण एवं परिचालन एवं स्काडा) कार्यालय  
कुमायु मण्डल हल्द्वानी  
मोबाइल न० 9412089275, ईमेल dp\_singh@ptcul.org

			19. Anything which is left to be mentioned here but required for successful completion of the aforementioned subject work shall be done <b>Central Board of Irrigation and Power Malcha Marg Chanakyapuri, New Delhi-110021</b> 20. CBIP Delhi shall submit a report on detailed points in four sets of hard copy duly spiraled binding as well as soft copy shall be submitted. 21. The safety guidelines prevalent in PTCUL must be followed.
2	GST	:	GST shall be paid extra as per applicable Government rules.
3	Tax	:	Tax shall be deducted at source as per applicable Government rules. A certificate to this effect may be given to the Contractor if required.
4	Date of Start of work	:	Order shall be considered as having come in to force from the date of issue of order.
5	Supply Completion	:	NA
6	Work completion	:	The work should be completed within 24 months from the date of issue of order.
7	Engineer of the contract		Superintending Engineer (T&C), Haldwani is the "Engineer of the contract" who shall be placing the order for the work with the contractor and signing the contract agreement and who has been inherently vested with such powers by corporation in this behalf and shall act as Engineer for the purpose of the contract.
8	Engineer in-charge		Respective Executive Engineer (T&C) shall be "Engineer in charge" for the subject work.
9	Liquidity damages	:	If the contract is delayed beyond the stipulated period mentioned in the contract. The liquidity damages shall be levied @ 0.5 % per week and maximum up to 10% of contract value.
10	Dispute		All Dispute arising out of this case under the jurisdiction local court at Kashipur and Honable High Court, Nainital.
11	Payment terms	:	1. 25% Payment will be made within 30 days after finalization of Audit plan, subject to availability of funds from PTCUL HQ. 2. 35% Payment will be made within 30 days after submission of preliminary reports verified by Executive Engineer of respective division, subject to availability of funds from PTCUL HQ. 3. 40 % Payment will be made within 30 days after submission of final reports verified by Executive Engineer of respective division, subject to availability of funds from PTCUL HQ.
12	Payment unit		Test & Commissioning Division, Kashipur shall be the payment unit and all units where is to be work done shall record the measurement and duly passed bills along with measurement book shall be submitted to payment unit.
13	Warranty period	:	NA.
14	Billing Address	:	Executive Engineer Test & Commissioning Division, PTCUL 400 KV Substation Campus, Kashipur (Uttarakhand)-244713, GSTIN No. (05AAECM1785FCZ9)

All other term and condition of this order shall be governed by the General conditions of the contract prevalent in PTCUL.

  
(D.P Singh)

Superintending Engineer(T&C), Haldwani

मुख्यालय एवंपंजीकृत कार्यालय:-विद्युतमवन, नजदीक-आई०एस०बी०टी० क्रासिंग, सहारनपुररोड, गाजरा, देहरादून-248002  
कारपोरेटआईडी न०: U40101UR2004GOI028675 दूरभाष न० 0135-2646000 फैक्स न० 0135-2643460 वेबसाइटwww.ptcul.org



पावर ट्रांसमिशन कारपोरेशन ऑफ उत्तराखण्ड लि०  
(उत्तराखण्ड सरकार का उपक्रम)  
अधीक्षण अभियन्ता (परीक्षण एवं परिचालन एवं स्काडा) कार्यालय  
कुमायु मण्डल हल्द्वानी  
मोबाइल नं० 9412089275, ईमेल dp\_singh@ptcul.org

No. 394 /SE (T&C)/PTCUL/ (H)/

Date:26.10.2023

Subject:- Corrigendum for the Order for the work of Protection Audit of 02 Nos 400 kV and 08 Nos 220KV sub-stations in

PTCUL

Joint Advisor

Central Board of Irrigation and Power

Malcha Marg Chanakyapuri,

New Delhi-110021

Email: mrchauhan@cbip.org.

Dear Sir,

In reference to above mentioned subject, please refer to kick off meeting held on dated 26.10.2023 for the work of Protection Audit of 02 Nos 400 kV and 08 Nos 220KV sub-stations in PTCUL against order no.376 dated 29.09.2023.

In this regard, kindly find enclosed herewith corrigendum of order no.376 dated 29.09.2023 (Annexure-1) with necessary amendements as discussed in aforementioned meeting.

This is for your kind information and necessary action.

Please acknowledge the receipt and acceptance of order.

(D.P Singh)

Superintending Engineer (T&C), Haldwani

Copy forwarded to the following for information and necessary action:-

1. Chief Engineer, T&C PTCUL, 132kV Substation Campus, Kathgodam Nainital.
2. Executive Engineer, T&C Division, Roorkee/Dehradun/Haldwani/Kashipur/Rishikesh with request to provide assistance and information to CBIP for the above work.
3. Director (Energy), Central Board of Irrigation and Power Malcha Marg Chanakyapuri, New Delhi-110021  
Email: [sanjeev@cbip.org](mailto:sanjeev@cbip.org)

मुख्यालय एवंपंजीकृत कार्यालय:-विद्युतमगन, नजदीक-आई०एस०बी०टी० क्रासिंग, सहारनपुररोड, गाजरा, देहरादून-248002  
कारपोरेटआईडी नं०: U40101UR2004GOI028675 दूरभाष नं० 0135-2646000 फैक्स नं० 0135-2643460 वेबसाइट[www.ptcul.org](http://www.ptcul.org)



**Annexure -1 – Work order corrigendum**

Scope: The detailed Scope work is as under:

S. No.	Clause of PO	Existing Clause					Modified Clause						
		Sr. No	Description	Unit	Qty	Amount	Total Amount	Sr. No	Description	Unit	Qty	Unit rate (Rs.)	Total Amount (Rs.)
1	Price Schedule	1	Protection Audit to be carried out for the following 10 nos. of the 400/220kV substations of PTCUL - 1. 400kV S/s Rishikesh 2. 400 KV S/s Kashipur 3. 220kV S/s Chamba 4. 220kV S/s Rishikesh 5. 220kV S/s Roorkee 6. 220kV S/s Haridwar (SIDCUL) 7. 220kV S/s Jhajra 8. 220 KV S/s Pantnagar. 9. 220 KV S/s Haldwani. 10. 220kV S/s Mahaukheraganj. TOTAL	Job	1	36,25,000	36,25,000	1	Protection Audit to be carried out for the following 10 nos of the 400/220kV substations of PTCUL - 1. 400kV S/s Rishikesh 2. 400 KV S/s Kashipur 3. 220kV S/s Chamba 4. 220kV S/s Rishikesh 5. 220kV S/s Roorkee 6. 220kV S/s Haridwar (SIDCUL) 7. 220kV S/s Jhajra 8. 220 KV S/s Pantnagar 9. 220 KV S/s Haldwani 10. 220kV S/s Mahaukheraganj TOTAL	Each	10	3,62,500	36,25,000
2	Terms and Conditions S. No. 1 – Scope	<ol style="list-style-type: none"> <li>There must be a kick off meeting for discussion on project plan before start of the work in field and the detailed plan of performance shall be submitted by CBIP.</li> <li>Requisite data shall be collected in standard format from PTCUL grid substations by authorized and experienced auditor.</li> <li>The site surveys and audit of grid substations of PTCUL shall be done by authorized and experienced auditor.</li> <li>Review of the implemented protection schemes/ philosophy for 400/220 kV substations which includes protection of transmission lines, interconnecting transformers, line/bus reactors, bus bar, bus couplers etc. with respect to</li> </ol>					<ol style="list-style-type: none"> <li>There must be a kick off meeting for discussion on project plan before start of the work in field and the detailed plan of performance shall be submitted by CBIP.</li> <li>Requisite data shall be collected in standard format from PTCUL grid substations by an experienced auditor.</li> <li>The site surveys and audit of grid substations of PTCUL shall be done by an experienced auditor.</li> <li>Review of the implemented protection schemes/philosophy for 400/220 kV substations which includes protection of transmission lines, interconnecting transformers, line/bus reactors, bus bar, bus couplers etc. with respect to</li> </ol>						





5. Clause of PO No.	Existing Clause	Modified Clause
	<p>couplers etc.as per latest guidelines of Ramakrishna committee/ CBIP/NRPC/international best practices, etc.</p> <p>5. Review the adequacy of primary and backup protection settings for protected equipment and suggest corrective measures where everyone compliance with respect to Ramakrishna committee/ CBIP/NRPC is found during the protection audit.</p> <p>6. Review of availability/healthiness of PLCC communication links used for protection systems.</p> <p>7. Review the healthiness/adequacy of 220/110/50V DC system available at substations for protection application.</p> <p>8. Review of availability/healthiness of GPS system and time synchronization facility used for protection.</p> <p>9. Review of availability/healthiness of recording instruments like DRs /ELs for transmission lines protection.</p> <p>10. Review of test reports for assessing the healthiness of circuit breakers, CT &amp; CVT based upon available test reports at sites.</p> <p>11. Field inspection of protection device for obsolescence of technology, suitability and healthiness.</p> <p>12. Directory of the protection system &amp; recommendation for replacement of obsolescence relays with compatible numerical relays will be provided.</p> <p>13. Checking of availability of DG Set/auxiliary DC supply at substations.</p> <p>14. Site visits for onsite protection audit, review and inspection of substations will be performed.</p> <p>15. Submission of the detailed report for the protection audit including the protection philosophy, reviewed settings and protection audit observations.</p> <p>16. The performance of above protection equipment like relays, circuit breaker, CT, CVT, DC battery bank, synchro facility, communication facility used for protection will be also checked through physical inspection and provided test reports/documents. These protection equipment's will be recommended for renovation and upgradation based on their performance accessed during protection audit and physical inspection.</p>	<p>tripping in last one year as per latest guidelines of Ramakrishna committee/ CBIP/NRPC/international best practices, which includes review of the following:</p> <p>a) Adequacy of primary and backup protection settings for protected equipment and suggest corrective measures</p> <p>b) Availability/healthiness of PLCC communication links used for protection systems.</p> <p>c) Healthiness/adequacy of 220/110/50V DC system available at substations for protection application.</p> <p>d) Availability/healthiness of GPS system and time synchronization facility used for protection.</p> <p>e) Availability/healthiness of recording instruments like DRs /ELs for transmission lines protection.</p> <p>f) Test reports for assessing the healthiness of circuit breakers, CT &amp; CVT based upon available test reports at sites.</p> <p>g) Field inspection of protection device for obsolescence of technology, suitability and healthiness.</p> <p>h) Prepare recommendation for replacement of obsolescence relays with compatible numerical relays will be provided.</p> <p>i) Checking of availability of DG Set / auxiliary DC supply at substations.</p> <p>5. Site visits for onsite protection audit, review and inspection of substations will be performed</p> <p>6. Submission of the detailed report for the protection audit including the protection philosophy, reviewed settings and protection audit observations.</p>
		<p>Deleted as it is covered in point 4 above.</p>







S. No.	Clause of PO	Existing Clause	Modified Clause
		<p>17. Review the availability healthiness of</p> <ul style="list-style-type: none"> <li>• Event recorders/ loggers' operation history</li> <li>• CT, CVT, CB</li> <li>• DC power supply</li> <li>• Auxiliary supply</li> <li>• Communication links</li> <li>• Time synchronization/ GPS</li> </ul> <p>18. Review of Testing and Maintenance records of all protective relays, Circuit Breakers, CT, CVT etc. Review of protection philosophy.</p> <p>19. Anything which is left to be mentioned here but required for successful completion of the aforementioned subject work shall be done Central Board of Irrigation and Power Malcha Marg Chanakyapuri, New Delhi-110021</p> <p>20. CBIP Delhi shall submit a report on detailed points in four sets of hard copy duly spiraled binding as well as soft copy shall be submitted.</p> <p>21. The safety guidelines prevalent in PTCUL must be followed.</p>	<p>7. Anything which is left to be mentioned here but required for successful completion of the aforementioned subject work shall be done by Central Board of Irrigation and Power.</p> <p>8. CBIP Delhi shall submit a protection report on detailed points in four sets of hard copy duly spiraled binding and in soft copy as well.</p> <p>9. The safety guidelines prevalent in PTCUL must be followed.</p>
3	Terms and Conditions — S. No. 6 - Work Completion	The work should be completed within 24 months from the date of issue of order	The work should be completed within 24 weeks from the date of issue of corrigendum.
4	Terms and Conditions — S. No. 8 - Engineer- in-charge	Respective Executive Engineer (T&C) shall be "Engineer in charge" for the subject work.	<p>The following Executive Engineers (T&amp;C) shall be "Engineer in charge" for the subject work:</p> <p>a) 400KV Rishikesh, 220KV Rishikesh, 220 KV Chamba – Mr. Harsh Verma (Ph. No.9412074038 &amp; Email: ee_tandc_rsh@ptcul.org).</p> <p>b) 400KV Kashipur, 220KV Pantnagar, 220KV Haldwani &amp; 220KV Mahuakheraganj – Mr. Asim Baig (Ph. No. 9412087885 &amp; Email: ee_tandc_ksp@ptcul.org).</p> <p>c) 220KV SIDCUL Haridwar, 220 KV Roorkee – Mr. Ashwini Kumar (Ph. No.7088117301 &amp; Email: ee_tandc_ks@ptcul.org).</p> <p>d) 220KV Jhajra – Mr. Ravindra Kumar (Ph. No. 9927744222 &amp; Email: ee_tandc_ddun@ptcul.org).</p>





4



S. No.	Clause of PO	Existing Clause	Modified Clause
5	Terms and Conditions - S. No. 11 - Payment Terms	<ol style="list-style-type: none"> <li>25% Payment will be made within 30 days after finalization of Audit plan, subject to availability of funds from PTCUL HQ.</li> <li>35% Payment will be made within 30 days after submission of preliminary reports verified by Executive Engineer of respective division, subject to availability of funds from PTCUL HQ.</li> <li>40 % Payment will be made within 30 days after submission of final reports verified by Executive Engineer of respective division, subject to availability of funds from PTCUL HQ.</li> </ol>	<ol style="list-style-type: none"> <li>25% Payment will be made within 30 days after finalization of Audit plan, subject to availability of funds from PTCUL HQ.</li> <li>35% Payment will be made within 30 days after submission of preliminary reports <b>on prorata basis</b> verified by Executive Engineer of respective division, subject to availability of funds from PTCUL HQ.</li> <li>40 % Payment will be made within 30 days after submission of final reports <b>on prorata basis</b> verified by Executive Engineer of respective division, subject to availability of funds from PTCUL HQ.</li> <li>The local travel, lodging &amp; boarding shall be arranged by PTCUL on free-of-cost basis for CBIP team visiting the substation</li> </ol>







## **Annexure – 8: Data Sheets**



# Contents

<b>Single Line Diagrams</b> .....	79
<i>Substation Single Line Diagram</i> .....	79
<i>AC Auxiliary System</i> .....	80
<i>DC Auxiliary System</i> .....	81
<i>SAS Architecture diagram</i> .....	82
<b>Transmission Lines</b> .....	83
<b>Bus-Bar Protection</b> .....	91
<b>AC Auxiliary System</b> .....	92
<b>DC Auxiliary System</b> .....	93
<b>Circuit Breakers</b> .....	94
<b>Current Transformer</b> .....	99
<b>Capacitive Voltage Transformer/Potential Transformer</b> .....	109
<b>Communication System</b> .....	119
<b>Transformer Protection</b> .....	120
<b>Network Diagram of Uttarakhand</b> .....	122
<b>Power Map of Uttarakhand</b> .....	123

# Protection Audit of 220/132/33kV Jhajhra Substation

## Annexure - 8

### Data Sheets

## Single Line Diagrams

### Substation Single Line Diagram

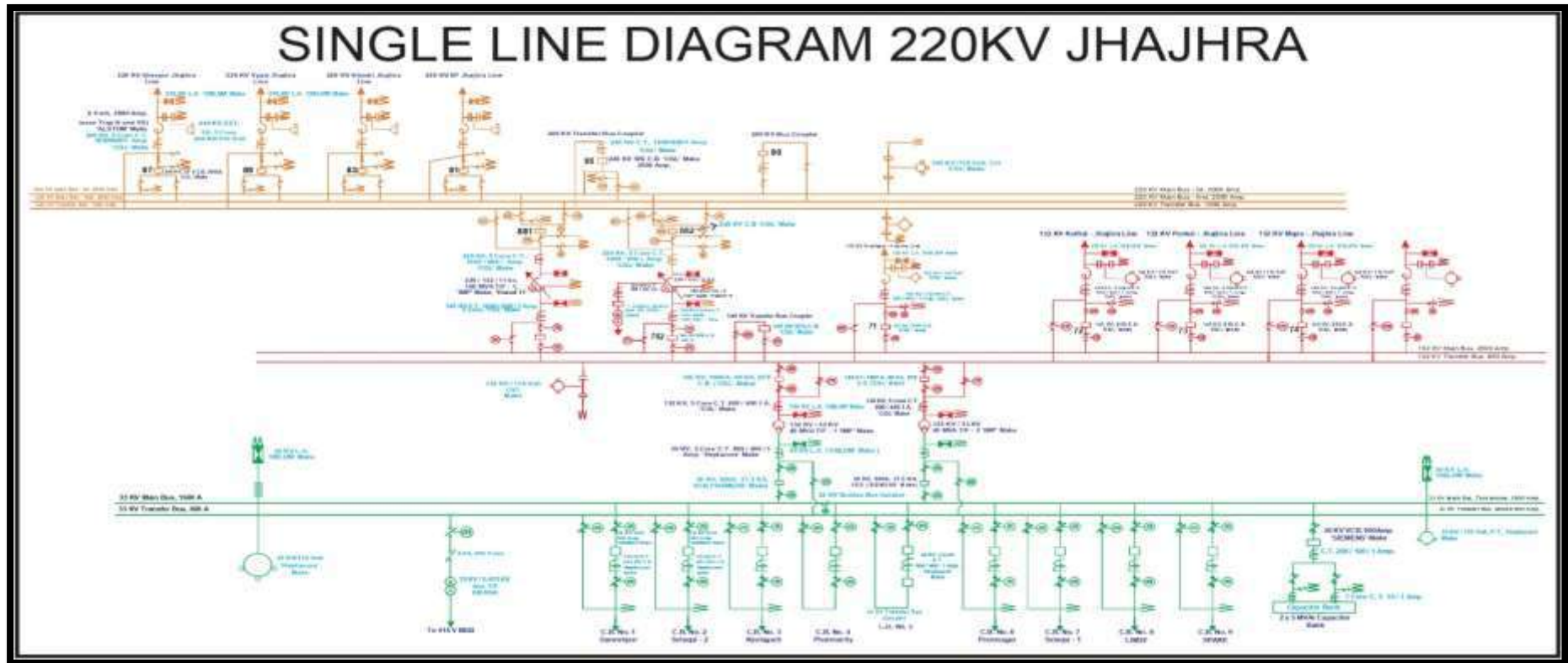

# AC Auxiliary System

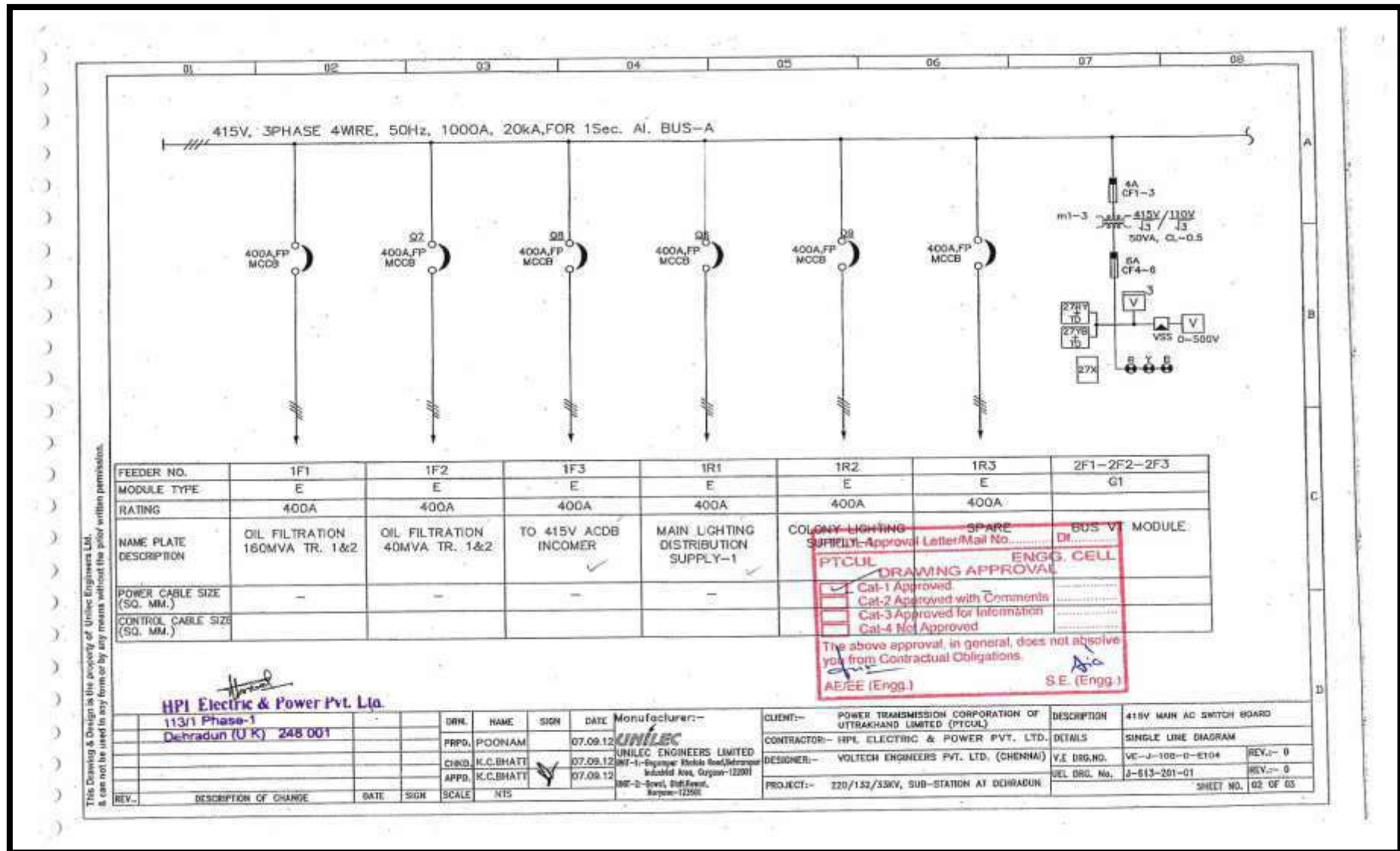

# DC Auxiliary System

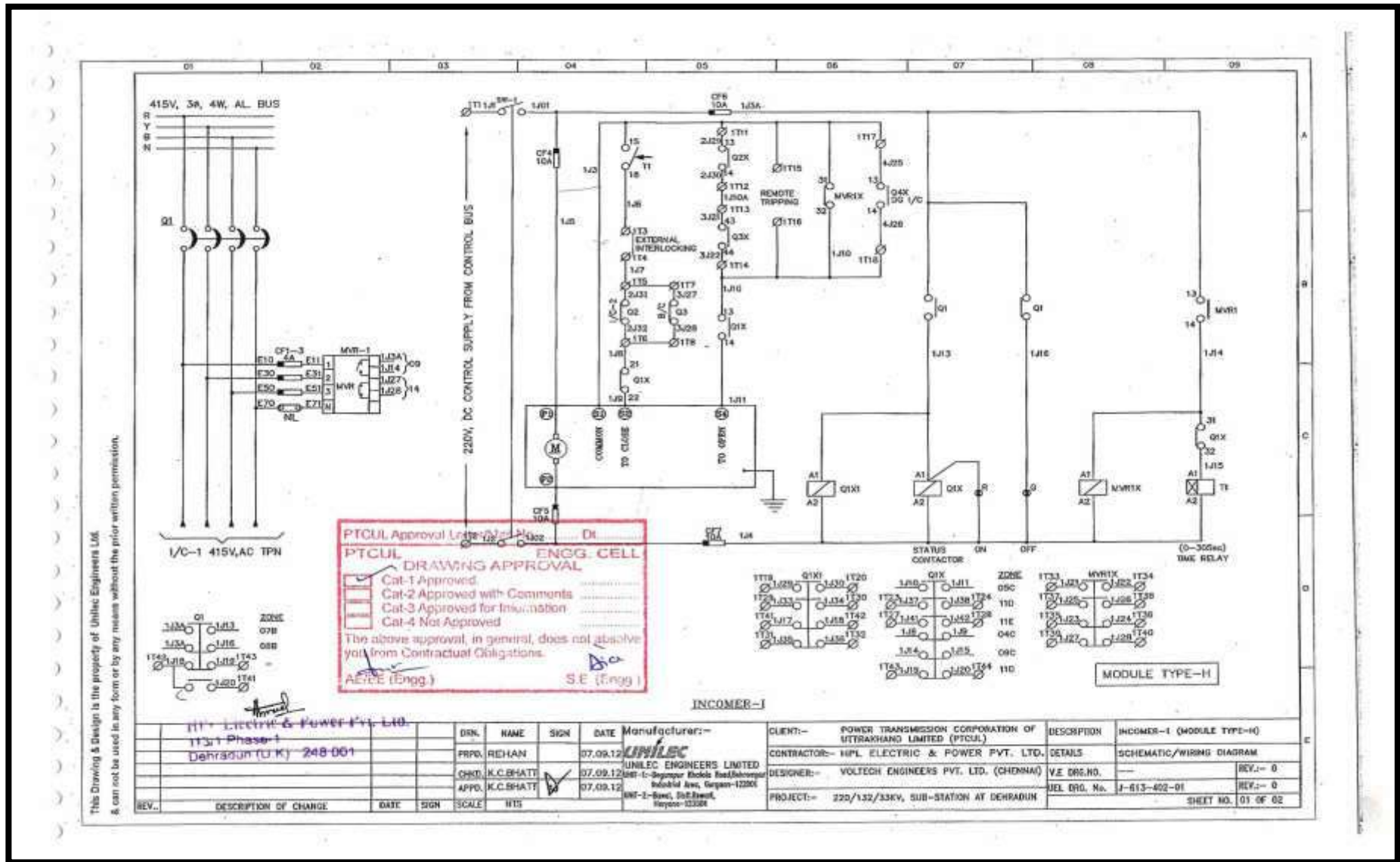



# SAS Architecture diagram

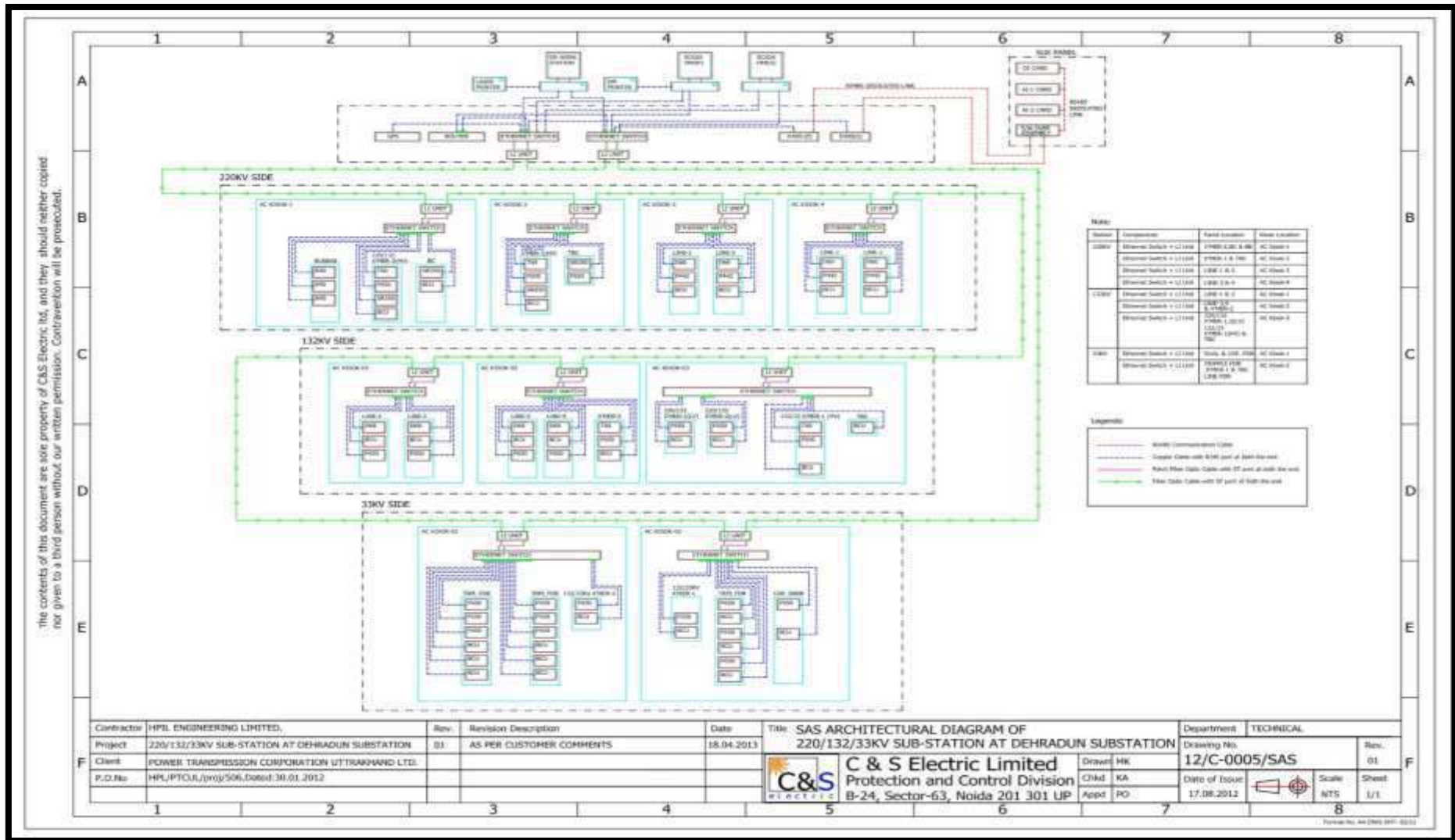

## Transmission Lines

SL. No.	Particulars	Details
<b>a</b>	Name and Length of Line	220 KV Jhajhra-IIP Line, 26 KM
<b>b</b>	Whether series compensated or not	No
<b>c</b>	Mode of communication used (PLCC/ OPGW)	PLCC
<b>d</b>	Relay Make and Model for Main-I and Main-II	GE Multiline D60 and Alstom P442
<b>e</b>	List of all active protections & settings	Enclosed
<b>f</b>	Carrier aided scheme, if any	No
<b>g</b>	Status of Power Swing/ Out of Step/ SOTF/ Breaker Failure/ Broken Conductor/ STUB/ Fault Locator/ Disturbance Recorder/ VT fuse fail/ Overvoltage Protection/ Trip Circuit supervision/ Auto-reclose/ Load encroachment etc.	Power Swing/ SOTF/ Broken Conductor/ Breaker Failure/ Fault Locator/ Disturbance Recorder/ VT fuse fail/ Trip Circuit supervision/ Auto-reclose Active
<b>h</b>	Relay connected to Trip Coil-1 or 2 or both	Both
<b>i</b>	CT ratio and PT ratio	1600/1, 220KV/ 110V
<b>j</b>	Feed from DC supply-1 or 2	DC-1 and Auto changeover at DC-2
<b>k</b>	Connected to dedicated CT core (mention name)	Core- 1 (Prot Main-1), Core- 2 (Prot Main-2), Core-3 (BCU & Metering), Core-4 Spare, Core-5 (Busbar Prot)
<b>l</b>	Other requirements for protection checking and validation	NA

<b>SL. No.</b>	<b>Equipment</b>	<b>Details</b>
<b>a</b>	Name and Length of Line	220 KV Jhajhra-Khodri Line, 27.53 Km.
<b>b</b>	Whether series compensated or not	No
<b>c</b>	Mode of communication used (PLCC/ OPGW)	PLCC
<b>d</b>	Relay Make and Model for Main-I and Main-II	GE Multiline D60 and Alstom P442
<b>e</b>	List of all active protections & settings	Enclosed
<b>f</b>	Carrier aided scheme, if any	N/A
<b>g</b>	Status of Power Swing/ Out of Step/ SOTF/ Breaker Failure/ Broken Conductor/ STUB/ Fault Locator/ Disturbance Recorder/ VT fuse fail/ Overvoltage Protection/ Trip Circuit supervision/ Auto-reclose/ Load encroachment etc.	Power Swing/ SOTF/ Broken Conductor/ Breaker Failure Fault Locator/ Disturbance Recorder/ VT fuse fail/ Trip Circuit supervision/ Auto-reclose Active
<b>h</b>	Relay connected to Trip Coil-1 or 2 or both	Both
<b>i</b>	CT ratio and PT ratio	1600/1, 220KV/ 110V
<b>j</b>	Feed from DC supply-1 or 2	DC-1 and Auto changeover at DC-2
<b>k</b>	Connected to dedicated CT core (mention name)	Core- 1 (Prot Main-1), Core- 2 (Prot Main-2), Core-3 (BCU & Metering), Core-4 Spare, Core-5 (Busbar Prot)
<b>l</b>	Other requirements for protection checking and validation	NA

<b>SL. No.</b>	<b>Equipment</b>	<b>Details</b>
<b>a</b>	Name and Length of Line	220 KV Jhajhra-PGCIL Line, 6.11 Km.
<b>b</b>	Whether series compensated or not	No
<b>c</b>	Mode of communication used (PLCC/ OPGW)	PLCC
<b>d</b>	Relay Make and Model for Main-I and Main-II	GE Multiline D60 and Alstom P442
<b>e</b>	List of all active protections & settings	Enclosed
<b>f</b>	Carrier aided scheme, if any	Carrier inter-tripping
<b>g</b>	Status of Power Swing/ Out of Step/ SOTF/ Breaker Failure/ Broken Conductor/ STUB/ Fault Locator/ Disturbance Recorder/ VT fuse fail/ Overvoltage Protection/ Trip Circuit supervision/ Auto-reclose/ Load encroachment etc.	Power Swing/ SOTF/ Broken Conductor/ Breaker Failure Fault Locator/ Disturbance Recorder/ VT fuse fail/ Trip Circuit supervision/ Auto-reclose Active
<b>h</b>	Relay connected to Trip Coil-1 or 2 or both	Both
<b>i</b>	CT ratio and PT ratio	1600/1, 220KV/ 110V
<b>j</b>	Feed from DC supply-1 or 2	DC-1 and Auto changeover at DC-2
<b>k</b>	Connected to dedicated CT core (mention name)	Core- 1 (Prot Main-1), Core- 2 (Prot Main-2), Core-3 (BCU & Metering), Core-4 Spare, Core-5 (Busbar Prot)
<b>l</b>	Other requirements for protection checking and validation	NA



<b>SL. No.</b>	<b>Equipment</b>	<b>Details</b>
<b>a</b>	Name and Length of Line	220 KV Jhajhra-Vyasi Line, 40.31 Km.
<b>b</b>	Whether series compensated or not	No
<b>c</b>	Mode of communication used (PLCC/ OPGW)	PLCC
<b>d</b>	Relay Make and Model for Main-I and Main-II	GE Multiline D60 and Alstom P442
<b>e</b>	List of all active protections & settings	Enclosed
<b>f</b>	Carrier aided scheme, if any	Carrier inter-tripping
<b>g</b>	Status of Power Swing/ Out of Step/ SOTF/ Breaker Failure/ Broken Conductor/ STUB/ Fault Locator/ Disturbance Recorder/ VT fuse fail/ Overvoltage Protection/ Trip Circuit supervision/ Auto-reclose/ Load encroachment etc.	Power Swing/ SOTF/ Broken Conductor/ Breaker Failure Fault Locator/ Disturbance Recorder/ VT fuse fail/ Trip Circuit supervision/ Auto-reclose Active
<b>h</b>	Relay connected to Trip Coil-1 or 2 or both	Both
<b>i</b>	CT ratio and PT ratio	1600/1, 220KV/ 110V
<b>j</b>	Feed from DC supply-1 or 2	DC-1 and Auto changeover at DC-2
<b>k</b>	Connected to dedicated CT core (mention name)	Core- 1 (Prot Main-1), Core- 2 (Prot Main-2), Core-3 (BCU & Metering), Core-5 (Busbar Prot)
<b>l</b>	Other requirements for protection checking and validation	NA

<b>SL. No.</b>	<b>Particulars</b>	<b>Details</b>
<b>a</b>	Name and Length of Line	132 KV Jhajhra-Dhalipur Line, 26.47 KM
<b>b</b>	Whether series compensated or not	No
<b>c</b>	Mode of communication used (PLCC/ OPGW)	NA
<b>d</b>	Relay Make and Model for Main and Backup Prot	GE Multilin D60 and F650
<b>e</b>	List of all active protections & settings	Enclosed
<b>f</b>	Carrier aided scheme, if any	No
<b>g</b>	Status of Power Swing/ Out of Step/ SOTF/ Breaker Failure/ Broken Conductor/ STUB/ Fault Locator/ Disturbance Recorder/ VT fuse fail/ Overvoltage Protection/ Trip Circuit supervision/ Auto-reclose/ Load encroachment etc.	Power Swing/ SOTF/ Broken Conductor/ Breaker Failure Fault Locator/ Disturbance Recorder/ VT fuse fail/ Trip Circuit supervision/ Auto-reclose Active
<b>h</b>	Relay connected to Trip Coil-1 or 2 or both	Both
<b>i</b>	CT ratio and PT ratio	800/1, 132KV/ 110V
<b>j</b>	Feed from DC supply-1 or 2	DC-1 and Auto changeover at DC-2
<b>k</b>	Connected to dedicated CT core (mention name)	Core- 1 (Dist Prot), Core- 2 (Backup Prot), Core-3 (BCU & Metering), Core-4 & 5 (Spare)
<b>l</b>	Other requirements for protection checking and validation	NA

<b>SL. No.</b>	<b>Equipment</b>	<b>Details</b>
<b>a</b>	Name and Length of Line	132 KV Jhajhra-Kulhal Line, 31.97
<b>b</b>	Whether series compensated or not	No
<b>c</b>	Mode of communication used (PLCC/ OPGW)	N/A
<b>d</b>	Relay Make and Model for Main and Backup Prot	GE Multiline D60 and F650
<b>e</b>	List of all active protections & settings	Enclosed
<b>f</b>	Carrier aided scheme, if any	No
<b>g</b>	Status of Power Swing/ Out of Step/ SOTF/ Breaker Failure/ Broken Conductor/ STUB/ Fault Locator/ Disturbance Recorder/ VT fuse fail/ Overvoltage Protection/ Trip Circuit supervision/ Auto-reclose/ Load encroachment etc.	Power Swing/ SOTF/ Broken Conductor/ Breaker Failure Fault Locator/ Disturbance Recorder/ VT fuse fail/ Trip Circuit supervision/ Auto-reclose Active
<b>h</b>	Relay connected to Trip Coil-1 or 2 or both	Both
<b>i</b>	CT ratio and PT ratio	800/1, 132KV/ 110V
<b>j</b>	Feed from DC supply-1 or 2	DC-1 and Auto changeover at DC-2
<b>k</b>	Connected to dedicated CT core (mention name)	Core- 1 (Dist Prot), Core- 2 (Backup Prot), Core-3 (BCU & Metering), Core-4 & 5 (Spare)
<b>l</b>	Other requirements for protection checking and validation	NA

<b>SL. No.</b>	<b>Equipment</b>	<b>Details</b>
<b>a</b>	Name and Length of Line	132 KV Jhajhra-Majra Line, 15.98 KM
<b>b</b>	Whether series compensated or not	No
<b>c</b>	Mode of communication used (PLCC/ OPGW)	N/A
<b>d</b>	Relay Make and Model for Main and Backup Prot	GE Multiline D60 and F650
<b>e</b>	List of all active protections & settings	Enclosed
<b>f</b>	Carrier aided scheme, if any	No
<b>g</b>	Status of Power Swing/ Out of Step/ SOTF/ Breaker Failure/ Broken Conductor/ STUB/ Fault Locator/ Disturbance Recorder/ VT fuse fail/ Overvoltage Protection/ Trip Circuit supervision/ Auto-reclose/ Load encroachment etc.	Power Swing/ SOTF/ Broken Conductor/ Breaker Failure Fault Locator/ Disturbance Recorder/ VT fuse fail/ Trip Circuit supervision/ Auto-reclose Active
<b>h</b>	Relay connected to Trip Coil-1 or 2 or both	Both
<b>i</b>	CT ratio and PT ratio	800/1, 132KV/ 110V
<b>j</b>	Feed from DC supply-1 or 2	DC-1 and Auto changeover at DC-2
<b>k</b>	Connected to dedicated CT core (mention name)	Core- 1 (Dist Prot), Core- 2 (Backup Prot), Core-3 (BCU & Metering), Core-4 & 5 (Spare)
<b>l</b>	Other requirements for protection checking and validation	NA

<b>SL. No.</b>	<b>Equipment</b>	<b>Details</b>
<b>a</b>	Name and Length of Line	132 KV Jhajhra-Purkul Line, 21.29 KM
<b>b</b>	Whether series compensated or not	No
<b>c</b>	Mode of communication used (PLCC/ OPGW)	N/A
<b>d</b>	Relay Make and Model for Main and Backup Prot	GE Multiline D60 and F650
<b>e</b>	List of all active protections & settings	Enclosed
<b>f</b>	Carrier aided scheme, if any	No
<b>g</b>	Status of Power Swing/ Out of Step/ SOTF/ Breaker Failure/ Broken Conductor/ STUB/ Fault Locator/ Disturbance Recorder/ VT fuse fail/ Overvoltage Protection/ Trip Circuit supervision/ Auto-reclose/ Load encroachment etc.	Power Swing/ SOTF/ Broken Conductor/ Breaker Failure Fault Locator/ Disturbance Recorder/ VT fuse fail/ Trip Circuit supervision/ Auto-reclose Active
<b>h</b>	Relay connected to Trip Coil-1 or 2 or both	Both
<b>i</b>	CT ratio and PT ratio	800/1, 132KV/ 110V
<b>j</b>	Feed from DC supply-1 or 2	DC-1 and Auto changeover at DC-2
<b>k</b>	Connected to dedicated CT core (mention name)	Core- 1 (Dist Prot), Core- 2 (Backup Prot), Core-3 (BCU & Metering), Core-4 & 5 (Spare)
<b>l</b>	Other requirements for protection checking and validation	NA

## Bus-Bar Protection

SL. No.	Equipment	Busbar Protection Relay
a	Busbar and redundant Relay make and model	GE make Model B90
b	Type of Busbar arrangement Relay make and model	GE make Model B90
c	Zones	Zone 1, Zone 2 and Zone 3
d	Dedicated CT core for each Busbar protection (Yes/No)	Yes (Core-5)
e	Breaker Failure Relay included (Yes/No) if additional then furnish make and model	Yes (LBB)
f	Trip issued to both Busbar Protection in case of enabling	Yes
g	Isolator indication and check relays	Yes
h	Other requirements for protection checking and validation	NA

## AC Auxiliary System

SL. No.	Equipment	AC auxiliary system
a	Source of AC auxiliary system	2X630 KVA S/S Transformer
b	Supply changeover between sources (Auto/Manual	Auto
c	Diesel generator (DG) details	250 KVA, Make- Jackson, Model-
d	Maintenance plan and supply changeover periodicity in DG	Quarterly
e	Single Line Diagram	Enclosed
f	Other requirements for protection checking and validation	NA

## DC Auxiliary System

SL. No.	Equipment	DC auxiliary system
a	Type of Batteries (Make, voltage, model)	1- HBL VRLA/220V/ 500AH- 02 Set 2- HBL VRLA/48V / 300AH - 02 Set
b	Status of battery Charger	Healthy
c	Measured voltage (positive to earth and negative to earth)	(+Ve to E) 117 V; (-Ve to E) 116 V
d	Availability of ground fault detectors	Available
e	Protection relays and trip circuits with independent DC sources	Available
f	Other requirements for protection checking and validation	NA



## Circuit Breakers

<b>220KV Jhajhra-IIP Line</b>		
<b>SL. No.</b>	<b>Equipment</b>	<b>Circuit Breaker</b>
<b>a</b>	Details and Status	Make-CGL, Sf6, 200-SFM-40S
<b>b</b>	Healthiness of Tripping Coil and Trip circuit supervision relay	Operational and Healthy
<b>c</b>	Single Pole/ Multi pole operation	Single Pole
<b>d</b>	Pole Discrepancy Relay available (Y/ N)	YES
<b>e</b>	Monitoring Devices for checking the dielectric medium	YES
<b>f</b>	Other requirements for protection checking and validation	NA

<b>220KV Jhajhra-Khodri Line</b>		
<b>SL. No.</b>	<b>Equipment</b>	<b>Circuit Breaker</b>
<b>a</b>	Details and Status	Make-CGL, Sf6, 200-SFM-40S
<b>b</b>	Healthiness of Tripping Coil and Trip circuit supervision relay	Operational and Healthy
<b>c</b>	Single Pole/ Multi pole operation	Single Pole
<b>d</b>	Pole Discrepancy Relay available (Y/ N)	YES
<b>e</b>	Monitoring Devices for checking the dielectric medium	Yes
<b>f</b>	Other requirements for protection checking and validation	NA

<b>220KV Jhajhra-PGCIL Line</b>		
<b>S. No.</b>	<b>Equipment</b>	<b>Circuit Breaker</b>
<b>a</b>	Details and Status	Make-CGL, Sf6, 200-SFM-40S
<b>b</b>	Healthiness of Tripping Coil and Trip circuit supervision relay	Operational and Healthy
<b>c</b>	Single Pole/ Multi pole operation	Single Pole
<b>d</b>	Pole Discrepancy Relay available (Y/ N)	YES
<b>e</b>	Monitoring Devices for checking the dielectric medium	Yes
<b>f</b>	Other requirements for protection checking and validation	28.05.2023 at Routine testing

<b>220 KV Jhajhra-Vyasi Line</b>		
<b>S. No.</b>	<b>Equipment</b>	<b>Circuit Breaker</b>
<b>a</b>	Details and Status	Make-CGL, Sf6, 200-SFM-40S
<b>b</b>	Healthiness of Tripping Coil and Trip circuit supervision relay	Operational and Healthy
<b>c</b>	Single Pole/ Multi pole operation	Single Pole
<b>d</b>	Pole Discrepancy Relay available (Y/ N)	YES
<b>e</b>	Monitoring Devices for checking the dielectric medium	YES
<b>f</b>	Other requirements for protection checking and validation	NA

<b>220/132 KV, 160MVA TF-1</b>		
<b>S. No.</b>	<b>Equipment</b>	<b>Circuit Breaker</b>
<b>a</b>	Details and Status	Make-CGL, Sf6, 200-SFM-40S
<b>b</b>	Healthiness of Tripping Coil and Trip circuit supervision relay	Operational and Healthy
<b>c</b>	Single Pole/ Multi pole operation	Single Pole (HV), Multi pole operation (LV)
<b>d</b>	Pole Discrepancy Relay available (Y/ N)	YES, Available on HV Side, Not Available at LV
<b>e</b>	Monitoring Devices for checking the dielectric medium	Yes
<b>f</b>	Other requirements for protection checking and validation	NA

<b>220/132 KV, 160MVA TF-2</b>		
<b>S. No.</b>	<b>Equipment</b>	<b>Circuit Breaker</b>
<b>a</b>	Details and Status	Make-CGL, Sf6, 200-SFM-40S
<b>b</b>	Healthiness of Tripping Coil and Trip circuit supervision relay	Operational and Healthy
<b>c</b>	Single Pole/ Multi pole operation	Single Pole (HV), Multi pole operation (LV)
<b>d</b>	Pole Discrepancy Relay available (Y/ N)	YES, Available on HV Side, Not Available at LV
<b>e</b>	Monitoring Devices for checking the dielectric medium	Yes
<b>f</b>	Other requirements for protection checking and validation	NA

<b>132 KV Jhajhra-Dhalipur Line</b>		
<b>S. No.</b>	<b>Equipment</b>	<b>Circuit Breaker</b>
<b>a</b>	Details and Status	Make-CGL, Sf6, 120-SFM-32B
<b>b</b>	Healthiness of Tripping Coil and Trip circuit supervision relay	Operational and Healthy
<b>c</b>	Single Pole/ Multi pole operation	Three Pole Gang operated
<b>d</b>	Pole Discrepancy Relay available (Y/ N)	YES
<b>e</b>	Monitoring Devices for checking the dielectric medium	YES
<b>f</b>	Other requirements for protection checking and validation	NA

<b>132 KV Jhajhra-Kulhal Line</b>		
<b>S. No.</b>	<b>Equipment</b>	<b>Circuit Breaker</b>
<b>a</b>	Details and Status	Make-CGL, Sf6, 120-SFM-32B
<b>b</b>	Healthiness of Tripping Coil and Trip circuit supervision relay	Operational and Healthy
<b>c</b>	Single Pole/ Multi pole operation	Three Pole Gang operated
<b>d</b>	Pole Discrepancy Relay available (Y/ N)	YES
<b>e</b>	Monitoring Devices for checking the dielectric medium	Yes
<b>f</b>	Other requirements for protection checking and validation	NA

<b>132 KV Jhajhra-Majra Line</b>		
<b>S. No.</b>	<b>Equipment</b>	<b>Circuit Breaker</b>
<b>a</b>	Details and Status	Make-CGL, Sf6, 120-SFM-32B
<b>b</b>	Healthiness of Tripping Coil and Trip circuit supervision relay	Operational and Healthy
<b>c</b>	Single Pole/ Multi pole operation	Three Pole Gang operated
<b>d</b>	Pole Discrepancy Relay available (Y/ N)	YES
<b>e</b>	Monitoring Devices for checking the dielectric medium	Yes
<b>f</b>	Other requirements for protection checking and validation	NA

<b>132 KV Jhajhra-Purkul Line</b>		
<b>S. No.</b>	<b>Equipment</b>	<b>Circuit Breaker</b>
<b>a</b>	Details and Status	Make-CGL, Sf6, 120-SFM-32B
<b>b</b>	Healthiness of Tripping Coil and Trip circuit supervision relay	Operational and Healthy
<b>c</b>	Single Pole/ Multi pole operation	Three Pole Gang operated
<b>d</b>	Pole Discrepancy Relay available(Y/ N)	YES
<b>e</b>	Monitoring Devices for checking the dielectric medium	Yes
<b>f</b>	Other requirements for protection checking and validation	-

## Current Transformer

220KV Jhajhra-IIP Line		
SL. No.	Equipment	Current Transformer
a	CT ID name and voltage level	Heptacare Power Industries
b	CT core connection details	5 No. Core: Core- 1 (Prot Main-1), Core- 2 (Prot Main-2), Core-3 (BCU & Metering), Core-5 (Busbar Prot)
c	Accuracy Class	PS, PS, 0.2, PS, PS
d	Whether Protection/ Metering	Both
e	CT ratio available and ratio adopted	1600/800/1, Prot: 1600/1 ; Met : 800/1
f	Details of last checking and validation of CT healthiness	30.01.2014 at Commissioning
g	Other requirements for protection checking and validation	NA
h	Other protection: Direction earth fault, negative sequence, over current, over voltage, over frequency, under voltage, under frequency, forward power, reverse power, out of step/ power swing, HVDC protection etc.	Direction earth fault

<b>220KV Jhajhra-Khodri Line</b>		
<b>SL. No.</b>	<b>Equipment</b>	<b>Current Transformer</b>
<b>a</b>	CT ID name and voltage level	Heptacare Power Industries
<b>b</b>	CT core connection details	Core- 1 (Prot Main-1), Core- 2 (Prot Main-2), Core-3 (BCU & Metering), Core-4 Spare, Core-5 (Busbar Prot)
<b>c</b>	Accuracy Class	PS, PS, 0.2, PS, PS
<b>d</b>	Whether Protection/ Metering	Both
<b>e</b>	CT ratio available and ratio adopted	1600/800/1, Prot : 1600/1 ; Met : 800/1
<b>f</b>	Details of last checking and validation of CT healthiness	30.01.2014 at Commissioning
<b>g</b>	Other requirements for protection checking and validation	-
<b>h</b>	Other protection: Direction earth fault, negative sequence, over current, over voltage, over frequency, under voltage, under frequency, forward power, reverse power, out of step/ power swing, HVDC protection etc.	Direction earth fault

<b>220KV Jhajhra-PGCIL Line</b>		
<b>SL. No.</b>	<b>Equipment</b>	<b>Current Transformer</b>
<b>a</b>	CT ID name and voltage level	Heptacare Power Industries
<b>b</b>	CT core connection details	Core- 1 (Prot Main-1), Core- 2 (Prot Main-2), Core- 3 (BCU & Metering), Core-4 Spare, Core-5 (Busbar Prot)
<b>c</b>	Accuracy Class	PS, PS, 0.2, PS, PS
<b>d</b>	Whether Protection/ Metering	Both
<b>e</b>	CT ratio available and ratio adopted	1600/800/1, Prot: 1600/1 ; Met : 1600/1
<b>f</b>	Details of last checking and validation of CT healthiness	10.06.2022 at Commissioning of New CT
<b>g</b>	Other requirements for protection checking and validation	NA
<b>h</b>	Other protection: Direction earth fault, negative sequence, over current, over voltage, over frequency, under voltage, under frequency, forward power, reverse power, out of step/ power swing, HVDC protection etc.	Direction earth fault



<b>220 KV Jhajhra-Vyasi Line</b>		
<b>SL. No.</b>	<b>Equipment</b>	<b>Current Transformer</b>
<b>a</b>	CT ID name and voltage level	Heptacare Power Industries
<b>b</b>	CT core connection details	Core- 1 (Prot Main-1), Core- 2 (Prot Main-2), Core- 3 (BCU & Metering), Core-4 Spare, Core-5 (Busbar Prot)
<b>c</b>	Accuracy Class	PS, PS, 0.2, PS, PS
<b>d</b>	Whether Protection/ Metering	Both
<b>e</b>	CT ratio available and ratio adopted	1600/800/1, Prot 1600/1 , Met 800/1
<b>f</b>	Details of last checking and validation of CT healthiness	13.04.2022 at commissioning
<b>g</b>	Other requirements for protection checking and validation	NA
<b>h</b>	Other protection: Direction earth fault, negative sequence, over current, over voltage, over frequency, under voltage, under frequency, forward power, reverse power, out of step/ power swing, HVDC protection etc.	Direction earth fault

<b>220/132 KV, 160MVA TF-1</b>		
<b>SL. No.</b>	<b>Equipment</b>	<b>Current Transformer</b>
<b>a</b>	CT ID name and voltage level	Heptacare Power Industries
<b>b</b>	CT core connection details	5 No. Core: Core- 1 (Diff Prot), Core- 2 (Backup Prot), Core-3 (BCU & Metering), Core-5 (Busbar Prot)
<b>c</b>	Accuracy Class	PS, PS, 0.2, PS, PS
<b>d</b>	Whether Protection/ Metering	Both
<b>e</b>	CT ratio available and ratio adopted	1600/800/1, 800/1
<b>f</b>	Details of last checking and validation of CT healthiness	30.01.2014 at Commissioning
<b>g</b>	Other requirements for protection checking and validation	NA
<b>h</b>	Other protection: Direction earth fault, negative sequence, over current, over voltage, over frequency, under voltage, under frequency, forward power, reverse power, out of step/ power swing, HVDC protection etc.	Direction earth fault, over current

<b>220/132 KV, 160MVA TF-2</b>		
<b>SL. No.</b>	<b>Equipment</b>	<b>Current Transformer</b>
<b>a</b>	CT ID name and voltage level	Heptacare Power Industries
<b>b</b>	0	5 No. Core: Core- 1 (Diff Prot), Core- 2 (Backup Prot), Core-3 (BCU & Metering), Core-5 (Busbar Prot)
<b>c</b>	Accuracy Class	PS, PS, 0.2, PS, PS
<b>d</b>	Whether Protection/ Metering	Both
<b>e</b>	CT ratio available and ratio adopted	1600/800/1, 800/1
<b>f</b>	Details of last checking and validation of CT healthiness	01.02.2014 at Commissioning
<b>g</b>	Other requirements for protection checking and validation	NA
<b>h</b>	Other protection: Direction earth fault, negative sequence, over current, over voltage, over frequency, under voltage, under frequency, forward power, reverse power, out of step/ power swing, HVDC protection etc.	Direction earth fault, over current

<b>132 KV Jhajhra-Dhalipur Line</b>		
<b>SL. No.</b>	<b>Equipment</b>	<b>Current Transformer</b>
<b>a</b>	CT ID name and voltage level	Heptacare Power Industries
<b>b</b>	CT core connection details	5 No. Core: Core- 1 (Dist Prot), Core- 2 (Backup Prot), Core-3 (BCU & Metering), Core-4 & 5 (Spare)
<b>c</b>	Accuracy Class	PS, PS, 0.2, PS, PS
<b>d</b>	Whether Protection/ Metering	Both
<b>e</b>	CT ratio available and ratio adopted	800/400/1, Prot 800/1, Met 400
<b>f</b>	Details of last checking and validation of CT healthiness	24.02.2017 at Commissioning
<b>g</b>	Other requirements for protection checking and validation	NA
<b>h</b>	Other protection: Direction earth fault, negative sequence, over current, over voltage, over frequency, under voltage, under frequency, forward power, reverse power, out of step/ power swing, HVDC protection etc.	Direction Over current & earth fault

<b>132 KV Jhajhra-Kulhal Line</b>		
<b>SL. No.</b>	<b>Equipment</b>	<b>Current Transformer</b>
<b>a</b>	CT ID name and voltage level	Heptacare Power Industries
<b>b</b>	CT core connection details	5 No. Core: Core- 1 (Dist Prot), Core- 2 (Backup Prot), Core-3 (BCU & Metering), Core-4 & 5 (Spare)
<b>c</b>	Accuracy Class	PS, PS, 0.2, PS, PS
<b>d</b>	Whether Protection/ Metering	Both
<b>e</b>	CT ratio available and ratio adopted	800/400/1, Prot 800/1, Met 400
<b>f</b>	Details of last checking and validation of CT healthiness	28.07.2015 at Commissioning
<b>g</b>	Other requirements for protection checking and validation	-
<b>h</b>	Other protection: Direction earth fault, negative sequence, over current, over voltage, over frequency, under voltage, under frequency, forward power, reverse power, out of step/ power swing, HVDC protection etc.	Direction Over current & earth fault

<b>132 KV Jhajhra-Majra Line</b>		
<b>SL. No.</b>	<b>Equipment</b>	<b>Current Transformer</b>
<b>a</b>	CT ID name and voltage level	Heptacare Power Industries
<b>b</b>	CT core connection details	5 No. Core: Core- 1 (Dist Prot), Core- 2 (Backup Prot), Core-3 (BCU & Metering), Core-4 & 5 (Spare)
<b>c</b>	Accuracy Class	PS, PS, 0.2, PS, PS
<b>d</b>	Whether Protection/ Metering	Both
<b>e</b>	CT ratio available and ratio adopted	800/400/1, Prot 400/1, Met 400
<b>f</b>	Details of last checking and validation of CT healthiness	28.07.2015 at Commissioning
<b>g</b>	Other requirements for protection checking and validation	-
<b>h</b>	Other protection: Direction earth fault, negative sequence, over current, over voltage, over frequency, under voltage, under frequency, forward power, reverse power, out of step/ power swing, HVDC protection etc.	Direction Over current & earth fault

<b>132 KV Jhajhra-Purkul Line</b>		
<b>SL. No.</b>	<b>Equipment</b>	<b>Current Transformer</b>
<b>a</b>	CT ID name and voltage level	Heptacare Power Industries
<b>b</b>	CT core connection details	5 No. Core: Core- 1 (Dist Prot), Core- 2 (Backup Prot), Core-3 (BCU & Metering), Core-4 & 5 (Spare)
<b>c</b>	Accuracy Class	PS, PS, 0.2, PS, PS
<b>d</b>	Whether Protection/ Metering	Both
<b>e</b>	CT ratio available and ratio adopted	800/400/1, Prot <u>800</u> /1, Met 400
<b>f</b>	Details of last checking and validation of CT healthiness	04.02.2017 at Commissioning
<b>g</b>	Other requirements for protection checking and validation	-
<b>h</b>	Other protection: Direction earth fault, negative sequence, over current, over voltage, over frequency, under voltage, under frequency, forward power, reverse power, out of step/ power swing, HVDC protection etc.	Direction Over current & earth fault

## Capacitive Voltage Transformer/Potential Transformer

220KV Jhajhra-IIP Line		
CVT Details		CVT: CBE-245/1050/50
SL. No.	Equipment	CVT
a	CVT ID name and voltage level	Make-CGL, 245KV
b	CVT core connection details	110/ $\sqrt{3}$ , 3Core
c	Accuracy Class	PS, PS, 0.2
d	Whether Protection/ Metering	Both
e	CVT ratio available and ratio adopted	220KV/ 110V
f	Details of last checking and validation of CVT healthiness	30.01.2014 at Commissioning
g	Other requirements for protection checking and validation	NA
h	Other protection: Direction earth fault, negative sequence, over current, over voltage, over frequency, under voltage, under frequency, forward power, reverse power, out of step/ power swing, HVDC protection etc.	Direction earth fault



<b>220KV Jhajhra-Khodri Line</b>		
<b>CVT Details</b>		CVT: CBE-245/1050/50
<b>S. No.</b>	<b>Equipment</b>	CVT
<b>a</b>	CVT ID name and voltage level	Make-CGL, 245KV
<b>b</b>	CVT core connection details	110/√3, 3Core
<b>c</b>	Accuracy Class	3P, 3P,0.2
<b>d</b>	Whether Protection/ Metering	Both
<b>e</b>	CVT ratio available and ratio adopted	220KV/ 110V
<b>f</b>	Details of last checking and validation of CVT healthiness	30.01.2014 at Commissioning
<b>g</b>	Other requirements for protection checking and validation	NA
<b>h</b>	Other protection: Direction earth fault, negative sequence, over current, over voltage, over frequency, under voltage, under frequency, forward power, reverse power, out of step/ power swing, HVDC protection etc.	Direction earth fault

<b>220KV Jhajhra-PGCIL Line</b>		
<b>CVT Details</b>		CVT: CBE-245/1050/50
<b>S. No.</b>	<b>Equipment</b>	CVT
<b>a</b>	CVT ID name and voltage level	Make-CGL, 245KV
<b>b</b>	CVT core connection details	110/√3, 3Core
<b>c</b>	Accuracy Class	3P, 3P,0.2
<b>d</b>	Whether Protection/ Metering	Both
<b>e</b>	CVT ratio available and ratio adopted	220KV/ 110V
<b>f</b>	Details of last checking and validation of CVT healthiness	30.01.2014 at Commissioning
<b>g</b>	Other requirements for protection checking and validation	NA
<b>h</b>	Other protection: Direction earth fault, negative sequence, over current, over voltage, over frequency, under voltage, under frequency, forward power, reverse power, out of step/ power swing, HVDC protection etc.	Direction earth fault

<b>220KV Jhajhra-Vyasi Line</b>		
<b>CVT Details</b>		CVT : CBE-245/1050/50
<b>S. No.</b>	<b>Equipment</b>	CVT
<b>a</b>	CVT ID name and voltage level	Make-CGL, 245KV
<b>b</b>	CVT core connection details	110/√3, 3Core
<b>c</b>	Accuracy Class	3P, 3P,0.2
<b>d</b>	Whether Protection/ Metering	Both
<b>e</b>	CVT ratio available and ratio adopted	220KV/ 110V
<b>f</b>	Details of last checking and validation of CVT healthiness	30.01.2014 at Commissioning
<b>g</b>	Other requirements for protection checking and validation	NA
<b>h</b>	Other protection: Direction earth fault, negative sequence, over current, over voltage, over frequency, under voltage, under frequency, forward power, reverse power, out of step/ power swing, HVDC protection etc.	Direction earth fault

<b>220/132 KV, 160MVA TF-1</b>		
<b>CVT Details</b>		CVT: CBE-245/1050/50
<b>S. No.</b>	<b>Equipment</b>	CVT
<b>a</b>	CVT ID name and voltage level	Make-CGL, 245KV
<b>b</b>	CVT core connection details	110/√3, 3Core
<b>c</b>	Accuracy Class	3P, 3P, 0.2
<b>d</b>	Whether Protection/ Metering	Both
<b>e</b>	CVT ratio available and ratio adopted	220KV/ 110V
<b>f</b>	Details of last checking and validation of CVT healthiness	30.01.2014 at Commissioning
<b>g</b>	Other requirements for protection checking and validation	NA
<b>h</b>	Other protection: Direction earth fault, negative sequence, over current, over voltage, over frequency, under voltage, under frequency, forward power, reverse power, out of step/ power swing, HVDC protection etc.	Direction earth fault,over current

<b>220/132 KV, 160MVA TF-2</b>		
<b>CVT Details</b>		CVT: CBE-245/1050/50
<b>S. No.</b>	<b>Equipment</b>	CVT
<b>a</b>	CVT ID name and voltage level	Make-CGL, 245KV
<b>b</b>	CVT core connection details	110/√3, 3Core
<b>c</b>	Accuracy Class	3P, 3P, 0.2
<b>d</b>	Whether Protection/ Metering	Both
<b>e</b>	CVT ratio available and ratio adopted	220KV/ 110V
<b>f</b>	Details of last checking and validation of CVT healthiness	30.01.2014 at Commissioning
<b>g</b>	Other requirements for protection checking and validation	NA
<b>h</b>	Other protection: Direction earth fault, negative sequence, over current, over voltage, over frequency, under voltage, under frequency, forward power, reverse power, out of step/ power swing, HVDC protection etc.	Direction earth fault,over current

<b>132 KV Jhajhra-Dhalipur Line</b>		
<b>CVT Details</b>		CVT: CBE-145/650/50
<b>SL. No.</b>	<b>Equipment</b>	CVT
<b>a</b>	CVT ID name and voltage level	Make-CGL, 145KV
<b>b</b>	CVT core connection details	110/√3, 3Core
<b>c</b>	Accuracy Class	3P, 3P, 0.2
<b>d</b>	Whether Protection/ Metering	Both
<b>e</b>	CVT ratio available and ratio adopted	HV: 132KV/ 110V
<b>f</b>	Details of last checking and validation of CVT healthiness	24.02.2017 at Commissioning
<b>g</b>	Other requirements for protection checking and validation	-
<b>h</b>	Other protection: Direction earth fault, negative sequence, over current, over voltage, over frequency, under voltage, under frequency, forward power, reverse power, out of step/ power swing, HVDC protection etc.	Direction earth fault, over current

<b>132 KV Jhajhra-Kulhal Line</b>		
<b>CVT Details</b>		CVT: CBE-145/650/50
<b>SL. No.</b>	<b>Equipment</b>	CVT
<b>a</b>	CVT ID name and voltage level	Make-CGL, 145KV
<b>b</b>	CVT core connection details	110/√3, 3Core
<b>c</b>	Accuracy Class	3P, 3P, 0.2
<b>d</b>	Whether Protection/ Metering	Both
<b>e</b>	CVT ratio available and ratio adopted	HV: 132KV/ 110V
<b>f</b>	Details of last checking and validation of CVT healthiness	28.07.2015 at Commissioning
<b>g</b>	Other requirements for protection checking and validation	-
<b>h</b>	Other protection: Direction earth fault, negative sequence, over current, over voltage, over frequency, under voltage, under frequency, forward power, reverse power, out of step/ power swing, HVDC protection etc.	Direction earth fault, over current

<b>132 KV Jhajhra-Majra Line</b>		
<b>CVT Details</b>		CVT: CBE-145/650/50
<b>S. No.</b>	<b>Equipment</b>	CVT
<b>a</b>	CVT ID name and voltage level	Make-CGL, 145KV
<b>b</b>	CVT core connection details	110/√3, 3Core
<b>c</b>	Accuracy Class	3P, 3P, 0.2
<b>d</b>	Whether Protection/ Metering	Both
<b>e</b>	CVT ratio available and ratio adopted	HV: 132KV/ 110V
<b>f</b>	Details of last checking and validation of CVT healthiness	28.07.2015 at Commissioning
<b>g</b>	Other requirements for protection checking and validation	-
<b>h</b>	Other protection: Direction earth fault, negative sequence, over current, over voltage, over frequency, under voltage, under frequency, forward power, reverse power, out of step/ power swing, HVDC protection etc.	Direction earth fault, over current



<b>132 KV Jhajhra-Purkul Line</b>		
<b>CVT Details</b>		CVT: CBE-145/650/50
<b>S. No.</b>	<b>Equipment</b>	CVT
<b>a</b>	CVT ID name and voltage level	Make-CGL, 145KV
<b>b</b>	CVT core connection details	110/√3, 3Core
<b>c</b>	Accuracy Class	3P, 3P, 0.2
<b>d</b>	Whether Protection/ Metering	Both
<b>e</b>	CVT ratio available and ratio adopted	HV: 132KV/ 110V
<b>f</b>	Details of last checking and validation of CVT healthiness	04.02.2017 at Commissioning
<b>g</b>	Other requirements for protection checking and validation	-
<b>h</b>	Other protection: Direction earth fault, negative sequence, over current, over voltage, over frequency, under voltage, under frequency, forward power, reverse power, out of step/ power swing, HVDC protection etc.	Direction earth fault, over current

## Communication System

Sl. No.	Particulars	Details
1	Mode of communication for Main- 1 and Main- 2 protection	Main-1 (PLCC), Main-2 (PLCC)
2	Mode of communication for data and speech communication	Speech communication- PLCC DATA communication- PLCC/Modem
3	Status of PLCC channels	Active
4	Time synchronization equipment details	GPS Clock Make - Masibus
5	OPGW on geographically diversified paths for Main- 1 and Main- 2 relay	Main-1
6	Other requirements for protection checking and validation	NA

## Transformer Protection

SL. No.	Equipment	132/33 KV, 80MVA TF-1
a	Whether two groups of protections used (Group A and Group B)	Group A
b	Do the groups have separate DC sources	NA
c	Relay Make and Model	GE Multiline T60, F650, Alstom CAG14
d	List of all active protections along with settings	Enclosed
e	Status of Differential Protection/ Restricted Earth Fault Protection/ Back-up Directional Overcurrent/ Backup Earth Fault/ Breaker Failure	Differential Protection/ Restricted Earth Fault Protection/ Back-up Directional Overcurrent/ Backup Earth Fault Active
f	Status of Oil Temperature Indicator/ Winding Temperature Indicator/ Bucholz/ Pressure Release Device etc.	Oil Temperature Indicator/ Winding Temperature Indicator/ Bucholz/ Pressure Release Device etc Active
g	Relay connected to Trip Coil-1 or 2 or both	Both
h	CT ratio and PT ratio	HV: 400/1, 132KV/110V, LV: 1600/1, 33KV/110V
i	Feed from DC supply-1 or 2	DC-1 and Auto changeover at DC-2
j	Connected to dedicated CT core (mention name)	Core- 1 (Dist Prot), Core- 2 (Backup Prot), Core- 3 (BCU & Metering), Core-4 & 5 (Spare)
k	Other requirements for protection checking and validation	NIFPS

<b>SL. No.</b>	<b>Equipment</b>	<b>132/33 KV, 80MVA TF-2</b>
<b>a</b>	Whether two groups of protections used (Group A and Group B)	Group A
<b>b</b>	Do the groups have separate DC sources	NA
<b>c</b>	Relay Make and Model	GE Multiline T60, F650, Alstom CAG14
<b>d</b>	List of all active protections along with settings	Enclosed
<b>e</b>	Status of Differential Protection/ Restricted Earth Fault Protection/ Back-up Directional Overcurrent/ Backup Earth Fault/ Breaker Failure	Differential Protection/ Restricted Earth Fault Protection/ Back-up Directional Overcurrent/ Backup Earth Fault Active
<b>f</b>	Status of Oil Temperature Indicator/ Winding Temperature Indicator/ Bucholz/ Pressure Release Device etc.	Oil Temperature Indicator/ Winding Temperature Indicator/ Bucholz/ Pressure Release Device etc Active
<b>g</b>	Relay connected to Trip Coil-1 or 2 or both	Both
<b>h</b>	CT ratio and PT ratio	HV: 400/1, 132KV/110V, LV: 1600/1, 33KV/110V
<b>i</b>	Feed from DC supply-1 or 2	DC-1 and Auto changeover at DC-2
<b>j</b>	Connected to dedicated CT core (mention name)	Core- 1 (Dist Prot), Core- 2 (Backup Prot), Core- 3 (BCU & Metering), Core-4 & 5 (Spare)
<b>k</b>	Other requirements for protection checking and validation	NIFPS

# Network Diagram of Uttarakhand

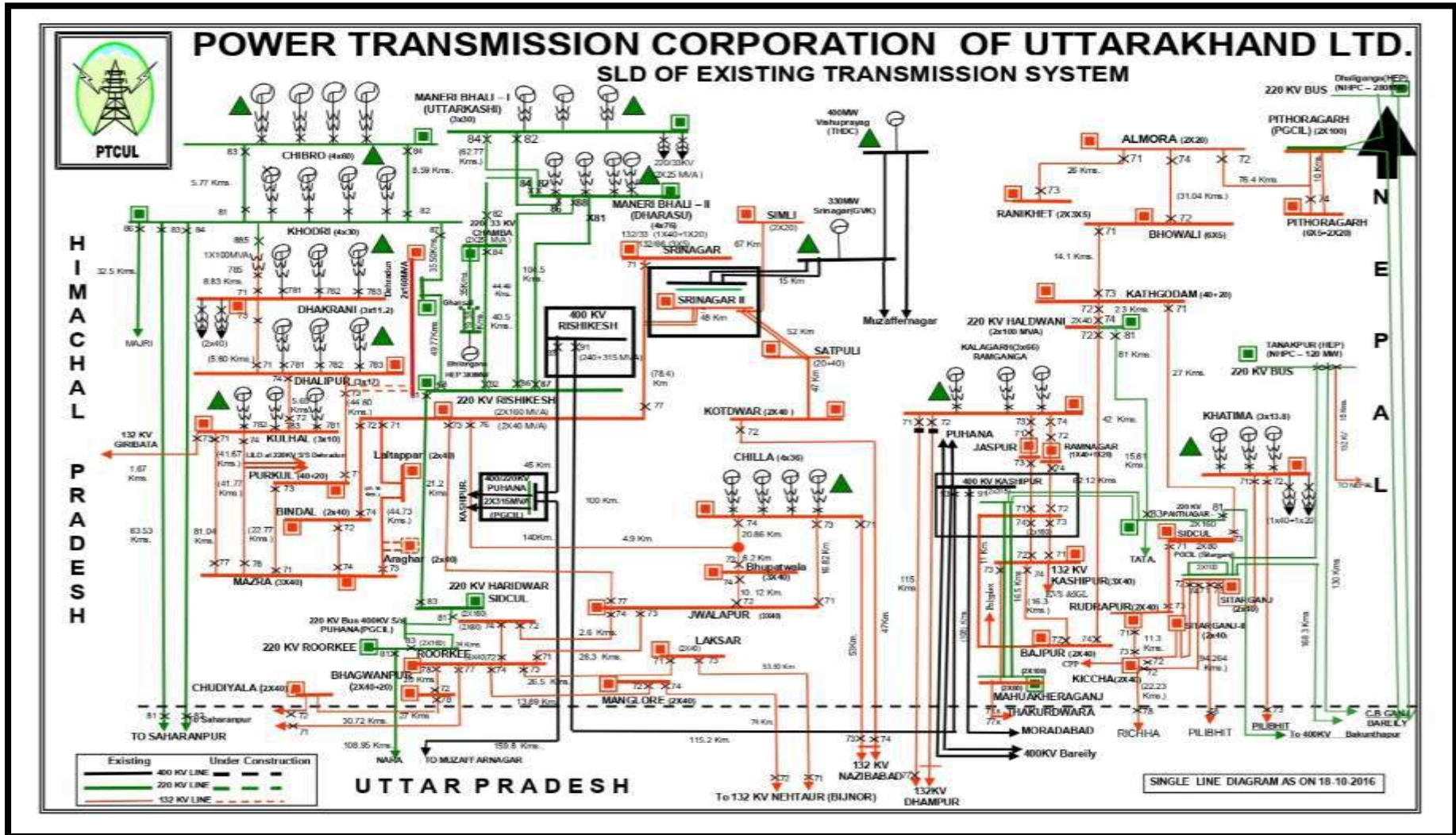



# Power Map of Uttarakhand

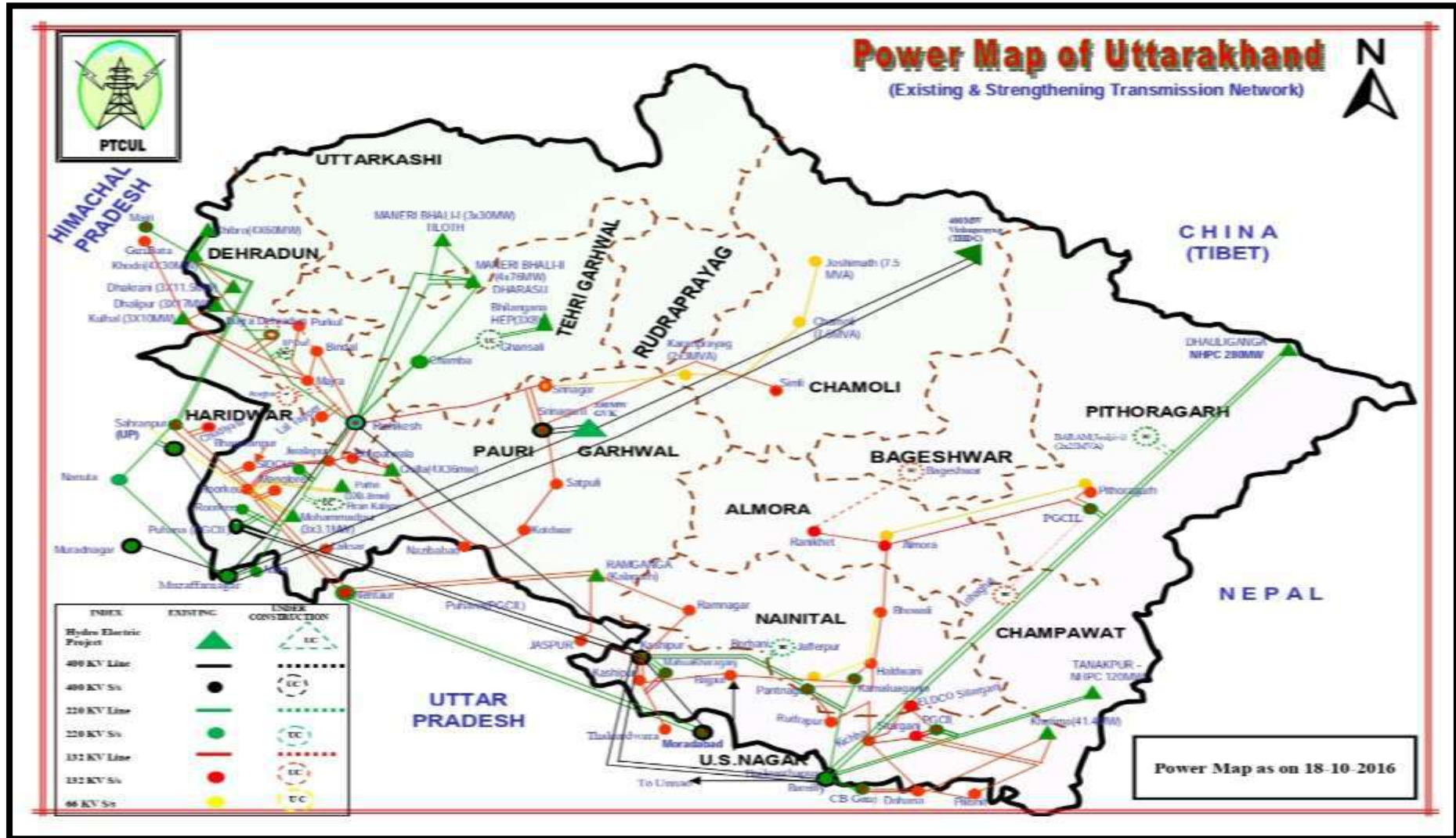

# Electrical Research And Development Association



<b>Particulars:</b>	<i>Report on Third Party Protection Audit of 400kV Sub-station of Generating Station at SSCTPS – Suratgarh, Rajasthan</i>
<b>Location:</b>	<i>Suratgarh, Rajasthan, India</i>
<b>Customer:</b>	<i>Suratgarh Super Critical Thermal Power Station (SSCTPS)</i>
<b>WO &amp; Date:</b>	<i>RVUN/STPS/SE(Elect.)/XEN-I/TN-2703(E)/D.380, dtd. 06.09.22</i>
<b>Submitted to</b>	<i>Superintending Engineer (S.E.) (Elect.), RRVUNL, SSCTPS Service Building, Prabhat Nagar, Suratgarh, Rajasthan. se1.ssctps@rrvun.com</i>
<b>Submitted by</b>	<i>Mr. Shailesh B. Modi (Sr. Manager), ERDA Road, Industrial Estate, G.I.D.C., Vadodara, Gujarat. Email:- shailesh.modi@erda.org</i>





## INDEX

Sr. No.			PARTICULARS	PAGE NO.
			Foreword	
			Acknowledgement	
			Executive Summary	
1			Introduction	1
2			Background	2
3			Scope of work	6
4			Objective	7
5			Methodology	9
6			Protection Audit of switchyard & substation	10
7			Short Circuit Study and Analysis	57
	7.1		Introduction	58
	7.2		Objective of Short Circuit Study	58
	7.3		Glossary for Short Circuit Study	58
	7.4		Methodology for Short Circuit Study	61
		7.4.1	ETAP Model	61
		7.4.2	System Parameter	63
		7.4.3	Short Circuit Study Configuration	64
	7.5		Short Circuit Study Result	65
	7.6		ETAP Crystal report	65
			ETAP reports – All Faults Summary Table	66
8			Relay Co-ordination Study	70
	8.1		Protection Relaying Philosophy	70
		8.1.1	Requirement of Protection system	70
	8.2		Over current Co-ordination	71
	8.3		Existing and recommended relay settings	74
	8.4		TCC Curves with respect to recommended settings	94
9			Review of Various Protection schemes	115
	9.1		Review of Distance Protection relay settings	115
		9.1.1	400 kV Bikaner Line-1 & Line-2 (Main-I)	115
		9.1.2	400 kV Bikaner Line-1 & Line-2 (Main-II)	117
		9.1.3	400 kV Babai Line 1 & 2 Feeders Settings Review Details – Main-I Relay- Siemens 7SA522	119



Sr. No.		PARTICULARS	PAGE NO.
	9.1.4	400 kV Babai Line 1 & 2 Feeders Settings Review Details – Main-II Relay Micom P442	122
	9.2	Review of Generator Transformer Protection Relay settings	124
	9.3	Review of Unit Transformer Protection Relay settings	125
	9.4	Review of Station Transformer Protection Relay settings	126
	9.5	Review of Reactor Protection Relay settings	127
	9.6	Review of 400 kV Interconnector Protection Relay settings	130
10		Review of Bus Bar protection relay settings	132
11		Recommendation	133
		Annexure-I: Single Line Diagram	

## **FORWARD**

*Electrical apparatus operates at various voltage levels and under abnormal operating conditions; protection is necessary for Safety of electrical equipments & Safety of human personnel under any abnormal conditions and for rapid restoration of the system.*

*The objectives of electrical system protection are improvement in system stability, system reliability, limit the extent & duration of interruption in service, enhancement of equipment life and safety of personnel. Protective relays has major role to play in this regards. Protective relays sense the status of power system and if any abnormality is detected due to some faulty operation they send the signal to the switching devices to operate and isolate the faulty section, if the protection system is designed properly.*

*Protection audit is required to determine the adequacy, healthiness, appropriateness of protection settings & schemes of individual elements associated with system protection. The protection audit is necessary to ensure the continuity of service.*

*It is very essential to ensure the continuity of the service & prevent the equipment failure due to abnormal system performance by adequate protection schemes in the system.*

*In view of the above; Rajasthan Rajya Vidyut Utpadan Nigam Limited (RRVUNL), Suratgarh Super Critical Thermal Power Station (SSCTPS) has appointed M/s. Electrical Research and Development Association (ERDA), Vadodara for **“Carrying out the Protection Audit of 400kV Sub-station of Suratgarh Super Critical Thermal Power Generating Station, Suratgarh, Rajasthan”.***

*This report gives the observations/verification of protective schemes and relay settings provided for electrical system of Suratgarh Super Critical Thermal Power Plant of Rajasthan Rajya Vidyut Utpadan Nigam Limited (RRVUNL), Suratgarh.*

## **ACKNOWLEDGEMENT**

*We are greatly indebted to Rajasthan Rajya Vidyut Utpadan Nigam Limited (RRVUNL), Suratgarh Super Critical Thermal Power Station (SSCTPS) for having entrusted to us the job to carry out this study.*

*We heartily acknowledge the support received from concerned officers of Suratgarh Super Critical Thermal Power Plant (SSCTPS) during the study.*

## **EXECUTIVE SUMMARY**

Electrical power is vital important for the growth & development of country & hence it is very essential to ensure the continuity of the service & prevent the equipment failure due to abnormal system performance by adequate protection schemes in the system.

The protection system is required for the detection and prompt isolation of the affected portion of the system whenever any faults or abnormality occurs.

Protection audit is required to determine the adequacy, healthiness, appropriateness of protection settings & schemes of individual elements associated with system protection. The protection audit is necessary to ensure the continuity of service.

In view of the above, SSCTPS-Suratgarh have awarded the work of ‘Protection Audit of 2 X 660 MW generating units with 400kV substation, SSCTPS-Suratgarh’ to M/s. Electrical Research and Development Association (ERDA), Vadodara. The SSCTPS-Suratgarh, a wholly owned subsidiary of Rajasthan Government and is under the management of Rajasthan Rajya Vidyut Utpadan Nigam Limited.

ERDA has carried out the protection audit study and reviewed the implemented protection schemes & setting of relays considering philosophy agreed for Northern Region and guidelines of CBIP.

### **SALIENT FEATURES:**

1	Tender No.	TN-63 (E)
2	Name of Customer	Rajasthan Rajya Vidyut Utpadan Nigam Limited
3	Name of work	Third Party Protection Audit of 400kV Sub-station of Generating Station at Suratgarh Super Critical Thermal Power Station (SSCTPS), Suratgarh
4	Name of Agency	Electrical Research and Development Association (ERDA), Vadodara
5	Letter of Intent No.	RVUN/SSCTPP/SE (Elect.) F./D. 335, dated 22.08.2022
6	Work Order No.	RVUN/STPS/SE (Elect.)/XEN-I/TN-2703 (E)/D. 380, dated 06.09.2022

SSCTPS-Suratgarh comprises of 2 nos. of 660 MW generators and its associated switchyard of 400kV with power evacuated through 1 nos. of 400kV feeder to Grid along with 2 nos. of 400kV interconnections.

List of various studies that have been carried out by ERDA on overall network are as listed under:

- Protection Audit of 400 kV switchyard and all protection equipments
- Relay Co-ordination study of network
- Checking of healthiness of DC system

The study carried out by ERDA team includes review of existing protection schemes of Power station equipment's like Generator Transformer, Unit Transformer, Station transformers, 400kV switchyard along with its Transmission lines network. The scope includes adequacy and verification of supply system with reference to regulatory guidelines, review of relay settings as per standards, Relay co-ordination, checking the healthiness of DC system etc. ERDA has suggested changes for improvement (if any) based on study of the existing network.

This report gives the observations/verification of protective schemes and relay settings provided for electrical system of Suratgarh Super Critical Thermal Power Plant (SSCTPS).

# 1

## INTRODUCTION:

The function of protection system may be defined as the detection of the fault and prompt isolation of the affected portion of the system whenever a short circuit or other abnormality occurs that might cause damage to, or adversely affect the operation of any portion of the system or the load that it supplies. The isolation of short circuits and overloads requires the application of protective equipment that senses when an abnormal current flow exists and then removes the affected portion from the system.

Protection system is required to be selective and sensitive so that the faults are quickly identified and cleared. However, in a well-designed system the protection system may operate very infrequently. Therefore, protective relays are rarely required to go into operation. However, these relays should maintain their integrity under normal system operating conditions and be ready for fault detection and isolation whenever required. Therefore, to assess the healthiness of the protection system the relays are required to be tested periodically.

Relay Co-ordination is the selection and/or setting of protective devices in order to isolate only the portion of the system where the abnormality occurs. Coordination is a basic ingredient of a well-designed electrical network protection system. This involves periodic fault studies followed by relay setting, checking and co-ordination studies. This study is essential in order to ensure that various relays function correctly with proper discrimination to provide reliable, sensitive and selective isolation of faulty power system equipment.

In this Protection Audit, the healthiness and adequacy of the various protection equipment's shall be checked and suitable recommendations are provided in order to improve the overall protection system performance. The purpose of carrying out this type of study is mainly to identify possible gaps if available in the protection system of the entire plant at various voltage levels.

The protection audit of Suratgarh Super Critical Thermal Power Plant has been carried out by Electrical Research and Development Association (ERDA) and this report showing the various outcomes and recommendations observed by ERDA during the Audit.

# 2

## BACKGROUND:

Two major grid disturbances took place in the Indian grid on the last two consecutive days of July 2012. The first disturbance took place in the Northern Region in the early hours of 30th July 2012 which resulted in failure of the Northern Regional Grid which was at that time meeting a load of around 36,000 MW. Subsequently, there was another grid disturbance in the Noon of 31st July 2012 resulting in failure of the Northern, Eastern and the North Eastern Regional grids. Ministry of Power constituted an Enquiry Committee headed by Chairman, CEA to analyze the causes of these disturbances and to suggest measures to avoid recurrence of such disturbances. The Committee recommended constitution of a Task Force to study the grid security issues.

The Task Force had discussed in detailed the various issues affecting the operation of the grid in a secure manner. The Task Force constituted two Sub-Committees – Study Sub-Committee for carrying out the system simulation studies corresponding to various extreme operation conditions in the grid both under normal and faulted conditions; and Protection Sub-Committee to examine the philosophy of relay and protection coordination adopted by the various utilities and also to evolve a common philosophy for relay and protection coordination in the integrated grid and also methodology for auditing and revision of protective relay setting at frequent intervals.

Accordingly, a sub-committee was constituted which has deliberated on the philosophy of relay and protection coordination and has come out with detailed recommendations on methodology for relay settings, audit of Protection system. As per the Task Force for proper protection coordination, all utilities should follow the guide lines and get their protection system audited from time to time as per the recommended methodology for relay settings, data format and checklist as recommended by the Protection Sub-Committee.

A data base of the settings of various relays also needs to be created, kept updated and verified during the audit. Data regarding settings of relays in their network should be compiled by the CTU and STUs and furnished to the RLDC and SLDC respectively and a copy should also submitted to RPC for maintaining the data base. Report of every audit should be submitted to RPC and also the RLDC/NLDC by the CTU and to the SLDCs by the STU's. Audit of protection system should be made mandatory by the CERC and SERC's in their regulations. This should be specified by the regulatory commissions in their Grid Code.

The Task Force has also observed that many of the utilities do not possess well trained and dedicated group to carry out studies for calculations for relay settings. The Task force strongly recommends that a dedicated group is required to be constituted and train them to carry out computer aided studies for relay settings.

There is also a need for periodic review of protection coordination and relay settings to take care of changes in network topology due to addition of new system elements – generating units, transmission lines, etc.

In view of above; SSCTPS decided for “Carrying out the Protection Audit of 400kV Sub-station of Suratgarh Super Critical Thermal Power Generating Station, Suratgarh, Rajasthan”.

.



Suratgarh Super Critical Thermal Power Plant is Steam based power station having 2 nos. of units 660 MW with installed capacity of 1320 MW.

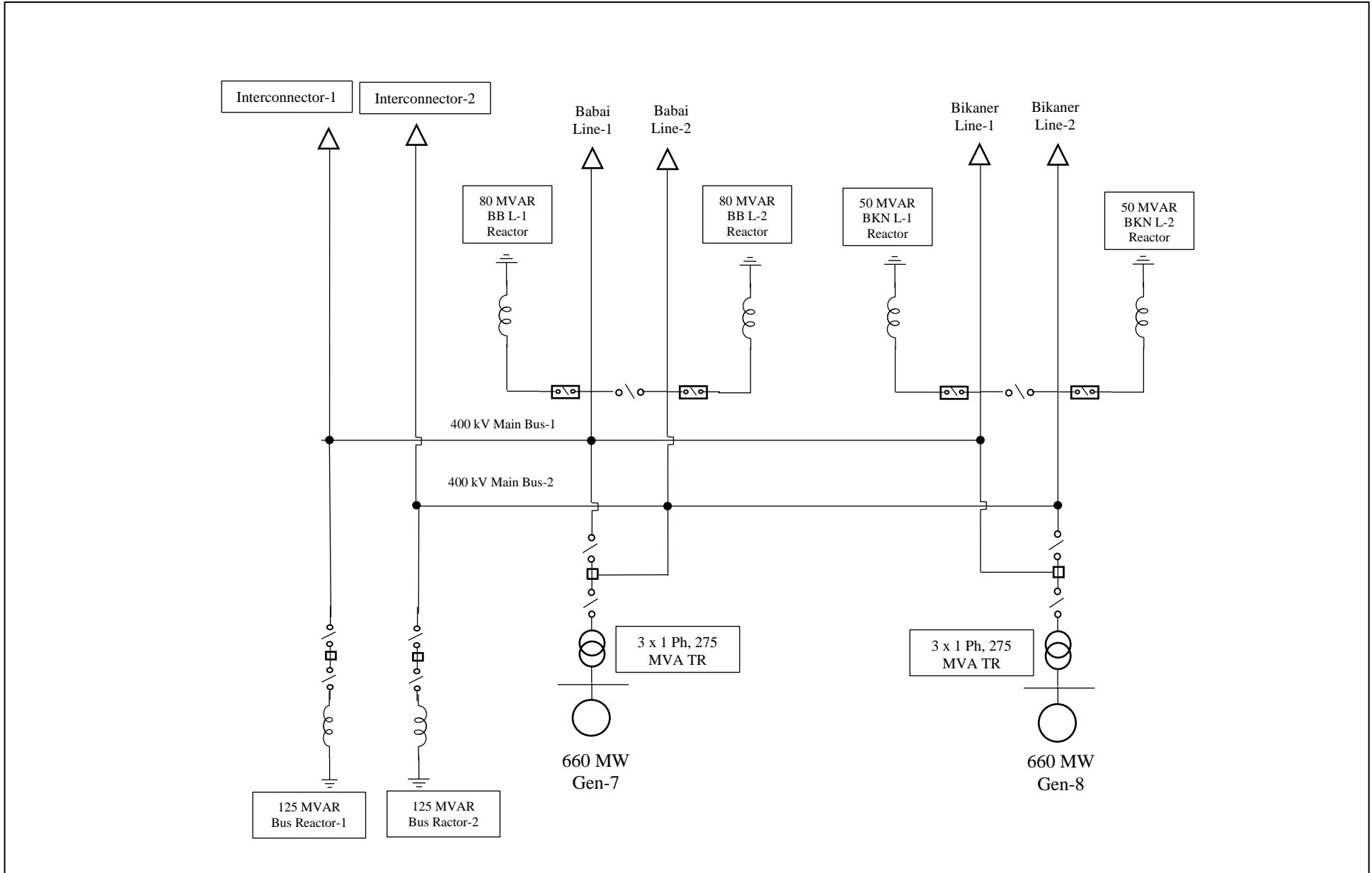

The above diagram showing the Single Line Diagram of complete 400 kV power system network of Suratgarh Super Critical Thermal Power Plant.

It has an installed capacity of 1320 MW (2 x 660MW) and is situated approximately 27 kms from the Suratgarh in the Sriganganagar district. Presently, there are 2 generators having capacity of 660 MW each and they are running and producing electric power on need basis. The total power generated from the 2 units are evacuated by 400kV Bikaner line (Double Circuit) & 2 nos. of 400kV interconnections connected to Suratgarh Super Thermal Power Plant (SSTP).

The electrical system comprise of following:

Sr. No.	Electrical Component	Installed Quantity
1	660 MW Generator, 21kV	2 Nos.
2	3 X 275 MVA, 420/ $\sqrt{3}$ /21kV Generating Transformer	2 Nos.
3	400 kV Double Circuit Transmission line	4 Nos.
4	400kV Interconnectors	2 Nos.
5	400kV Tie	5 Nos.
6	40 MVA, 21/11.5 kV Unit Transformer	4 Nos.
7	125/62.5/62.5 MVA 21/11.5/11.5 kV Station Transformers	2 Nos.
8	400kV 50 MVAR Line Reactor	2 Nos.
9	400kV 80 MVAR Line Reactor	2 Nos.
10	400kV 125 MVAR Bus Reactor	2 Nos.

In this Power plant, the 2 nos. of generators generating voltage at 21 kV level. This voltage is step up to 400 kV with the help of 2 set of 3 x 275 MVA Generating Transformer. The power is evacuated to 400 kV Bikaner line (Double Circuit) and 2 nos. of 400 kV interconnectors.

Suratgarh Super Critical Thermal Power Station operated by Rajasthan Rajya Vidyut Utpadan Nigam which is a state enterprise & hence it is very essential to ensure the continuity of the service & prevent the equipment failure due to abnormal system performance by inadequate protection schemes in the system.

In view of the above; Rajasthan Rajya Vidyut Utpadan Nigam has assigned the work to M/s. Electrical Research and Development Association (ERDA), Vadodara for Carrying out the Protection Audit of 400kV switchyard of Suratgarh Super Critical Thermal Power Plant, Suratgarh, Rajasthan.

# 3

## SCOPE OF WORK:

The scope of work is to carry out the Protection Audit of 2 X 660 MW generating units with 400 kV switchyard at Suratgarh Super Critical Thermal Power Plant as per Work Order No. RVUN/STPS/SE (Elect.)/XEN-I/TN-2703 (E)/D. 380, dtd. 06.09.2022.

The glimpses of Scope of Work are as shown below:

- 1) Protection audit of 400kV with interconnectors, Reactors, GTs etc.
- 2) Review of the implemented protection scheme/philosophy and setting in the 400kV substations & its major equipments as per CBIP publication no. 274 etc.
- 3) To carry out relay co-ordination studies for the different protection schemes
- 4) To check the adequacy / healthiness of primary and backup protection schemes and settings and recommend the corrective action
- 5) Checking healthiness / adequacy and proper load distribution on DCDB 220kV DC and suggest corrective measures in case of any problem.
- 6) Review of availability / healthiness of communication links like PLCC/Optical Fibre & recording instruments namely DR & event loggers along with time synchronization unit.
- 7) Review of test reports of relays & circuit breakers
- 8) Field inspection of existing protection devices for obsolescence of technology, suitability, healthiness

# 4

## OBJECTIVE:

ERDA is assigned to carry out the Protection Audit of 2 X 660 MW generating units with 400 kV switchyards at Suratgarh Super Critical Thermal Power Plant.

Following major activities are covered under this assignment:

- 1) Protection Audit of 400 kV switchyards covering all protection equipments
- 2) Checking healthiness of DC system
- 3) Carrying out the Power system studies on 400 kV Suratgarh Super Critical Thermal Plant network etc.

The objectives of electrical system protection are improvement in system stability, system reliability, limit the extent & duration of interruption in service, enhancement of equipment life and safety of personnel. Protective relays has major role to play in this regards. Protective relays sense the status of power system and if any abnormality is detected due to some faulty operation they send the signal to the switching devices to operate and isolate the faulty section, if the protection system is designed properly.

### **Protection Audit of 400 kV switchyard and all protection equipments**

ERDA has carried out the Protection Audit on 400kV switchyard & control room of Suratgarh Super Critical Thermal Power Plant. During this activity, the protection equipments like CT, CVT, PT, Circuit Breaker, Transformer, Lightning Arrestor details have been captured. The details of the relays installed in the control room have been captured and recorded. ERDA has also reviewed the various protections given in the relays and recorded the same.

### **Checking Healthiness of the DC system**

General healthiness of DC system Voltage is checked with regard to 'Earth fault' in 220 V DC system of C&R Panel supply, at 220 kV switchyard. In the 220kV switchyard, the DC voltage in the both sources require to be checked and recorded. The DC voltage in the chargers having automatically switchover from float to boost required to be checked and recorded. The condition of the battery checked along with the battery room.

**Carrying out the various Power System Studies of 400 kV Suratgarh network:**

**Short circuit study** is being carried out on entire system in order to check adequacy of the protective equipments in the event of fault. SSCTPS-Suratgarh system simulated in the various fault conditions like:

- a) Single phase to ground fault
- b) Phase to Phase fault
- c) Three phase fault

The simulation will give us the fault current against each conditions which then compared with the protection equipment in order to check its adequacy. If breaker operates in all the aforesaid fault effectively then system is stable and if not then breaker rating needs to be optimized. To find out the magnitude of currents flow during an electrical fault. Comparing these calculated values against the protective device rating in order to find system is safely protected. Each interrupting device is analyzed to determine whether it is appropriately designed and sized to interrupt circuit in the event of short circuit.

Short Circuit studies are carried out to evaluate steady state and transient state behavior of the system after the addition various loads. Based on the full load current and fault level calculation, ratings of the protective scheme are decided.

**Relay Co-ordination Study** is being carried out in order to find the required operation to be performed by desired relay & co-ordination schemes must guarantee fast, selective & reliable relay operation to isolate the power system from the faulted conditions. This study is done in order to prevent nuisance tripping in the power system. In the event of fault, desired relay shall operate immediately & isolate the faulty part from the network. There should not be any nuisance tripping in the system. Relay Co-ordination is useful in order to have smooth and reliable operation of entire network during normal & abnormal condition.

ERDA conducted the aforesaid studies on the entire SSCTPS-Suratgarh network with the help of suitable software. The entire system as provided by the SSCTPS-Suratgarh personnel simulated in the software and system data i. e. voltage level, transformer rating, relay settings, breaker capacity etc. is entered in the software.

This report provides the observations found by ERDA during the Protection audit activities of various equipments installed at SSCTPS-Suratgarh along with verification of protective scheme and relay settings of entire SSCTPS-Suratgarh electric network.

# 5

## METHODOLOGY:

The entire Protection Audit on Suratgarh Power Plant is conducted based on the Northern Region Protection Committee (NRPC) etc. guidelines. The same is as shown below:

### Protection Philosophy agreed for implementation in Northern Region (NRPC)

Sr. No.	Protection Setting	Reach & Time
1.	<b>Long lines Zone-1</b>	80% of the Protected line, Instantaneous
	<b>Zone-2</b>	100% of the Protected line + 50% of the shortest line emanating from the far end bus bar or 120% of the Protected line whichever is higher. Time Setting: 350ms for short lines ( $\leq 100\text{km}$ ) and 500ms for long lines $> 100\text{km}$ .
	<b>Zone-3</b>	120% of the protected line + 100% of the longest line emanating from the far end bus bar or 100% of the Protected line + 100% of the longest line emanating from the far end bus bar + 25% of the longest line emanating from the far end of the second line considered, whichever is lower. The zone setting to be limited such that it will not reach into the next voltage level. Time Setting: 1000m sec.
	<b>Zone- 3R</b>	25% of the Zone-1 reach. Time Setting: 1000m sec.
2.	<b>Lines with Series and other compensations in the vicinity of Substation</b>	70% of the Protected line. 100ms-time delay for allowing correct distance measurement after the series capacitor is bypassed.
3.	<b>Power Swing Blocking</b>	Block tripping in all zones, all lines. Out of Step tripping to be applied on all inter regional tie lines Deblock time delay = 2s
4.	<b>Protection for broken conductor</b>	Negative Sequence current to Positive Sequence current ratio more than 0.2 ( $I_2/I_1 \geq 0.2$ ) Only for alarm: Time delay = 3-5 sec
5.	<b>Carrier Protection</b>	To be applied on all 400kV and 220 kV lines with the only exception of Radial feeders.
6.	<b>Back up Protection</b>	1) On 400 & 220 kV lines with 2 Main Protections, back up Earth Fault protections alone to be provided. No Over current protection to be applied. 2) On 220 kV and lower voltage lines with only one Main protection Back up protection by IDMT O/C and E/F to be applied.
7.	<b>Auto Re-closing with dead time.</b>	Single pole trip and re-closing Dead time = 1.0s. Reclaim time = 25.0s
8.	<b>LBB Protection and busbar protection</b>	To be applied on all 400kV and 220 kV sub stations with the only exception of 220 kV radial fed bus bars. LBB Current sensor $I > 20\%$ In LBB time delay = 200ms

6

# PROTECTION AUDIT OF SWITCHYARD & SUBSTATION

<b>OBSERVATIONS &amp; STATUS</b>		
<b>Item No</b>	<b>Issues</b>	<b>Remark</b>
<b>1</b>	<b>Recommendation of last Protection Audit</b>	<b>Status of works &amp; Reason for Pending/ Suggestion</b>
	Not Applicable	Not Applicable
<b>2</b>	<b>Review of Existing Setting at Substations</b>	
	ERDA has collected the existing relay settings of relays.	Yes
<b>3</b>	<b>Disturbance recorder - list of 3 trappings in last 6 months</b>	<b>Recommended Action(s)</b>
	No disturbance recorder tripping details maintained by SSCTPS	It is recommended to maintain the DR data in proper way
3.a	DR as well as EL records for the trappings available (Yes / No)	EL Not Available, DR records available
3.b	Records available for tripping analysis and corrective action taken	Yes
3.c	Time Synch Matched Between EL signals and DR signals (Yes/No)	Yes
3.d	Digital Signal of DR named properly (main CB Trip, Z1 Trip etc) (Yes/No)	Yes
<b>4</b>	<b>Chronic Reason of tripping, if any</b>	
	Not Applicable	Not Applicable
<b>5</b>	<b>Existing process for records of changes incorporated in the relay settings</b>	<b>Attach Correspondence if any</b>
	SSCTPS has maintained the settings of all the relays as provided by M/s. BHEL	Existing settings are already mentioned in this report.
<b>6</b>	<b>Overvoltage grading for parallel line (time &amp; peak up grading, provided or not)</b>	<b>Recommended Action(s)</b>
	Nil	Nil
<b>7</b>	<b>Other deficiencies / Nonconformity observed (including the major non-conformities mentioned in the audit format. Ex. Single Ac source etc.)</b>	<b>Recommended Action(s)</b>
	Nil	Nil



**Line Distance Protection - Check List (Bikaner Line 1)**

**Audited data**

No.	Relay configuration - Line distance protection				
1	Name and length of line	Bikaner Line 1, 142 kms.			
2	Series compensated Y/N	No			
3	Is this a cable feeder/line feeder/composite feeder (Line + cable)	No			
4	Which mode of communication is used (PLCC/OPGW)	Both			
5	<b>Details of Relays</b>		<b>Main-1 Relay</b>	<b>Main-2 Relay</b>	<b>Other relays (Back up Relay, DR, FL etc.)</b>
	Details of composite type numerical relay		Siemens 7SA52	MiCOM P442	SIPROTEC 7VK61
	Relay Make and model		Siemens	Schneider	Siemens
	Whether the relay is functional	Yes/No	Yes	Yes	Yes
	Date of testing		January, 2017	January, 2017	January, 2017
	Mention all the active protections out of- 21,87L,67,67N,51,51N	21/87L/67/67N/51/51N	Overvoltage, SOTF, STUB,O/C, E/F, VT fuse fail, Broken Conductor, Distance, Directional O/C, Directional E/F etc.	Overvoltage, SOTF, STUB,O/C, E/F, VT fuse fail, Broken Conductor, Distance, Directional O/C, Directional E/F etc.	R/Y/B ph INITIATION, LINE 86 A/B INITIATION, BUS 96 A/B INITIATION, LBB OPTD. etc.
	Mode of carrier aided scheme for 21 (If POR Scheme is used whether current reversal Guard logic implemented?)	Accelerated under reach/ Permissive under reach/ Intercropping under reach/ permissive under reach/ Blocking over reach/ Phase comparison protection (for PLCC)		Permissive Under Reach	Permissive Under Reach
Carrier aided scheme active for 67/67N			Yes	Yes	-

	Mode of Carrier aided scheme for 67/67N	Directional comparison Protection (Permissive) / Directional Comparison Protection (Blocking)	Directional Comparison Protection (Blocking)	Directional Comparison Protection (Blocking)	-
	For 87L which scheme is used? (Pilot wire communication / digital communication)		N. A.	N. A.	N. A.
	Power swing/out of step active?	Yes/No	Yes	Yes	-
	SOTF Active ?	Yes/No	Yes	Yes	-
	Auto reclose (79) active?	Yes/No	Yes	Yes	-
	Breaker failure active	Yes/No	-	-	Yes
	Load Encroachment active	Yes/No	Yes	Yes	-
	Stub protection active	Yes/No	Yes	Yes	-
	Fault Locator active?	Yes/No	Yes	Yes	-
	Disturbance recorder active?	Yes/No	Yes	Yes	-
6	Relay connected to trip coil-1/Trip coil-2 or both?		Both	Both	Both
7	Feed from DC supply 1/DC supply-2		DC Supply 1	DC Supply 2	DC Supply 2
8	Connected to dedicated CT core? Define CT core no. to which the relay is connected		Core 6	Core 5	Core 2
9	CT ratio selected		3000/1	3000/1	3000/1
10	VT ratio selected		400kV/110V	400kV/110V	-
11	VT Fuse failure protection	Yes/No	Yes	Yes	-
12	Overvoltage protection available	Yes/No	Yes	Yes	-
	Functional with two stage protection	Yes/No	Yes	Yes	-
13	Are all the auxiliary relays (94) considered for Line protection (Main-1/Main-2/Backup) provided with supervision Relays (74/94)?	Yes/No	Yes	Yes	-
14	Do the line protection panels have supervision relay for DC supply-1 and DC supply-2 (74/DC-1 & 74/DC2)?	Yes/No	Yes	Yes	-

**Line Distance Protection - Check List (Bikaner Line 2)**

**Audited data**

No.	Relay configuration - Line distance protection				
1	Name and length of line	Bikaner Line 2, 142 kms.			
2	Series compensated Y/N	No			
3	Is this a cable feeder/line feeder/composite feeder (Line+cable)	No			
4	Which mode of communication is used (PLCC/OPGW)	Both			
5	<b>Details of Relays</b>		<b>Main-1 Relay</b>	<b>Main-2 Relay</b>	<b>Other relays (Back up relay, DR, FL etc.)</b>
	Details of composite type numerical relay		Siemens 7SA52	MiCOM P442	SIPROTEC 7VK61
	Relay Make and model		Siemens	Schneider	Siemens
	whether the relay is functional	Yes/No	Yes	Yes	Yes
	Date of testing		January, 2017	January, 2017	January, 2017
	Mention all the active protections out of- 21,87L,67,67N,51,51N	21/87L/67/67N/51/51N	Overvoltage, SOTF, STUB,O/C, E/F, VT fuse fail, Directional O/C, Directional E/F, Broken Conductor, Distance etc.	Overvoltage, SOTF, STUB,O/C, E/F, VT fuse fail, Directional O/C, Directional E/F, Broken Conductor, Distance etc.	R/Y/B ph INITIATION, LINE 86 A/B INITIATION, BUS 96 A/B INITIATION, LBB etc
	Mode of carrier aided scheme for 21 (If POR Scheme is used whether current reversal Guard logic implemented?)	Accelerated under reach/ Permissive under reach/ Intercropping under reach/ permissive under reach/ Blocking over reach/ Phase comparison protection (for PLCC)	Permissive Under Reach	Permissive Under Reach	-
	Carrier aided scheme active for 67/67N		Yes	Yes	-

**Line Distance Protection - Check List (Bikaner Line 2)**

	Mode of Carrier aided scheme for 67/67N	Directional comparison Protection (Permissive) / Directional Comparison Protection (Blocking)	Directional Comparison Protection (Blocking)	Directional Comparison Protection (Blocking)	-
	for 87L which scheme is used? ( Pilot wire communication /digital communication)		N. A.	N. A.	N. A.
	Power swing/out of step active?	Yes/No	Yes	Yes	-
	SOTF Active ?	Yes/No	Yes	Yes	-
	Auto reclose (79) active?	Yes/No	Yes	Yes	-
	Breaker failure active	Yes/No	-	-	Yes
	Load Encroachment active	Yes/No	Yes	Yes	-
	Stub protection active	Yes/No	Yes	Yes	-
	Fault Locator active?	Yes/No	Yes	Yes	-
	Disturbance recorder active?	Yes/No	Yes	Yes	-
6	Relay connected to trip coil-1/Trip coil-2 or both?		Both	Both	Both
7	Feed from DC supply 1/DC supply-2		DC Supply 1	DC Supply 2	DC Supply 2
8	Connected to dedicated CT core? Define CT core no. to which the relay is connected		Core 6	Core 5	Core 2
9	CT ratio selected		3000/1	3000/1	3000/1
10	VT ratio selected		400kV/110V	400kV/110V	-
11	VT Fuse failure protection	Yes/No	Yes	Yes	-
12	Overvoltage protection available	Yes/No	Yes	Yes	-
	Functional with two stage protection	Yes/No	Yes	Yes	-
13	Are all the auxiliary relays (94) considered for Line protection (Main-1/Main-2/Backup) provided with supervision Relays (74/94)?	Yes/No	Yes	Yes	-

**Line Distance Protection - Check List (Bikaner Line 2)**

14	Do the line protection protection panels have supervision relay for DC supply-1 and DC supply-2 (74/DC-1 & 74/DC2)?	Yes/No	Yes	Yes	-
----	---	--------	-----	-----	---

**Line Distance Protection - Check List (Babai Line 1)**

**Audited data**

No	Relay configuration - Line distance protection				
1	Name and length of line	Babai Line 1, 245 kms.			
2	Series compensated Y/N	No			
3	Is this a cable feeder/line feeder/composite feeder (Line+cable)	No			
4	Which mode of communication is used (PLCC/OPGW)	Both			
5	<b>Details of Relays</b>		Main-1 Relay	Main-2 Relay	Other relays (Back up relay, DR, FL etc)
	Details of composite type numerical relay		Siemens 7SA52	MiCOM P442	SIPROTEC 7VK61
	Relay Make and model		Siemens	Schneider	Siemens
	whether the relay is functional	Yes/No	Yes	Yes	Yes
	Date of testing		January, 2017	January, 2017	January, 2017
	Mention all the active protections out of- 21,87L,67,67N,51,51N	21/87L/67/67N/51/51N	Overvoltage, SOTF, STUB,O/C, E/F, VT fuse fail, Directional O/C, Directional E/F, Broken Conductor, Distance etc.	Overvoltage, SOTF, STUB,O/C, E/F, VT fuse fail, Directional O/C, Directional E/F, Broken Conductor, Distance etc.	R/Y/B ph INITIATION, LINE 86 A/B INITIATION, BUS 96 A/B INITIATION, LBB etc

**Line Distance Protection - Check List (Babai Line 1)**

	Mode of carrier aided scheme for 21 (If POR Scheme is used whether current reversal Guard logic implemented?)	Accelerated under reach/ Permissive under reach/ Intercropping under reach/ permissive under reach/ Blocking over reach/ Phase comparison protection (for PLCC)	Permissive Under Reach	Permissive Under Reach	-
	Carrier aided scheme active for 67/67N		Yes	Yes	-
	Mode of Carrier aided scheme for 67/67N	Directional comparison Protection (Permissive) / Directional Comparison Protection (Blocking)	Directional Comparison Protection (Blocking)	Directional Comparison Protection (Blocking)	-
	for 87L which scheme is used? ( Pilot wire communication /digital communication)		N. A.	N. A	N. A.
	Power swing/out of step active?	Yes/No	Yes	Yes	-
	SOTF Active?	Yes/No	Yes	Yes	-
	Auto reclose (79) active?	Yes/No	Yes	Yes	-
	Breaker failure active	Yes/No	-	-	Yes
	Load Encroachment active	Yes/No	Yes	Yes	-
	Stub protection active	Yes/No	Yes	Yes	-
	Fault Locator active?	Yes/No	Yes	Yes	-
	Disturbance recorder active?	Yes/No	Yes	Yes	-
6	Relay connected to trip coil-1/Trip coil-2 or both?		Both	Both	Both
7	Feed from DC supply 1/DC supply-2		DC Supply 1	DC Supply 2	DC Supply 2
8	Connected to dedicated CT core? Define CT core no. to which the relay is connected		Core 6	Core 5	Core 2
9	CT ratio selected		3000/1	3000/1	3000/1
10	VT ratio selected		400kV/110V	400kV/110V	-
11	VT Fuse failure protection	Yes/No	Yes	Yes	-

**Line Distance Protection - Check List (Babai Line 1)**

12	Overvoltage protection available	Yes/No	Yes	Yes	-
	Functional with two stage protection	Yes/No	Yes	Yes	-
13	Are all the auxiliary relays (94) considered for Line protection (Main-1/Main-2/Backup) provided with supervision Relays (74/94)?	Yes/No	Yes	Yes	-
14	Do the line protection panels have supervision relay for DC supply-1 and DC supply-2 (74/DC-1 & 74/DC2)?	Yes/No	Yes	Yes	-

**Line Distance Protection - Check List (Babai Line 2)**

**Audited data**

No .	Relay configuration - Line distance protection				
1	Name and length of line	Babai Line 2, 245 kms.			
2	Series compensated Y/N	No			
3	Is this a cable feeder/line feeder/composite feeder (Line + Cable)	No			
4	Which mode of communication is used (PLCC/OPGW)	Both			
5	<b>Details of Relays</b>		Main-1 Relay	Main-2 Relay	Other relays (Back up Relay, DR, FL etc.)
	Details of composite type numerical relay		Siemens 7SA52	MiCOM P442	SIPROTEC 7VK61
	Relay Make and model		Siemens	Schneider	Siemens
	Whether the relay is functional	Yes/No	Yes	Yes	Yes
	Date of testing		January, 2017	January, 2017	January, 2017

**Line Distance Protection - Check List (Babai Line 2)**

	Mention all the active protections out of- 21,87L,67,67N,51,51N	21/87L/67/67N/51/51N	Overvoltage, SOTF, STUB,O/C, E/F, VT fuse fail, Directional O/C, Directional E/F, Broken Conductor, Distance etc.	Overvoltage, SOTF, STUB,O/C, E/F, VT fuse fail, Directional O/C, Directional E/F, Broken Conductor, Distance etc.	R/Y/B ph INITIATION LINE 86 A/B INITIATION BUS 96 A/B INITIATION LB*B etc
	Mode of carrier aided scheme for 21 (If POR Scheme is used whether current reversal Guard logic implemented?)	Accelerated under reach/ Permissive under reach/ Intertripping under reach/ permissive under reach/ Blocking over reach/ Phase comparison protection (for PLCC)	Permissive Under Reach	Permissive Under Reach	-
	Carrier aided scheme active for 67/67N		Yes	Yes	-
	Mode of Carrier aided scheme for 67/67N	Directional comparison Protection (Permissive) / Directional Comparison Protection (Blocking)	Directional Comparison Protection (Blocking)	Directional Comparison Protection (Blocking)	-
	for 87L which scheme is used? ( Pilot wire communication /digital communication)		N. A.	N. A.	N. A.
	Power swing/out of step active?	Yes/No	Yes	Yes	-
	SOTF Active ?	Yes/No	Yes	Yes	-
	Auto reclose (79) active?	Yes/No	Yes	Yes	-
	Breaker failure active	Yes/No	-	-	Yes
	Load Encroachment active	Yes/No	Yes	Yes	-
	Stub protection active	Yes/No	Yes	Yes	-
	Fault Locator active?	Yes/No	Yes	Yes	-
	Disturbance recorder active?	Yes/No	Yes	Yes	-
6	Relay connected to trip coil-1/Trip coil-2 or both?		Both	Both	Both



**Line Distance Protection - Check List (Babai Line 2)**

7	Feed from DC supply 1/DC supply-2		DC Supply 1	DC Supply 2	DC Supply 2
8	Connected to dedicated CT core? Define CT core no. to which the relay is connected		Core 6	Core 5	Core 2
9	CT ratio selected		3000/1	3000/1	3000/1
10	VT ratio selected		400kV/110V	400kV/110V	-
11	VT Fuse failure protection	Yes/No	Yes	Yes	-
12	Overvoltage protection available	Yes/No	Yes	Yes	-
	Functional with two stage protection	Yes/No	Yes	Yes	-
13	Are all the auxiliary relays (94) considered for Line protection (Main-1/Main-2/Backup) provided with supervision Relays (74/94)?	Yes/No	Yes	Yes	-
14	Do the line protection panels have supervision relay for DC supply-1 and DC supply-2 (74/DC-1 & 74/DC2)?	Yes/No	Yes	Yes	-

**Line Distance Protection - Check List (Interconnector 1 & 2)**

**Audited data**

No.	Relay configuration - Line distance protection				
1	Name and length of line	Interconnector Line 1 & 2, 2.5 kM.			
2	Series compensated Y/N	No			
3	Is this a cable feeder/line feeder/composite feeder (Line+cable)	No			
4	Which mode of communication is used (PLCC/OPGW)	Both			
5	<b>Details of Relays</b>		Main-1 Relay	Main-2 Relay	Other relays (Back up relay, DR, FL etc)

**Line Distance Protection - Check List (Interconnector 1 & 2)**

Details of composite type numerical relay		Siemens 7SD5	Siemens 7SD5	SIPROTEC 7VK61
Relay Make and model		Siemens 7SD5	Siemens 7SD5	Siemens
whether the relay is functional	Yes/No	Yes	Yes	Yes
Date of testing		October, 2016	October, 2016	October, 2016
Mention all the active protections out of- 21,87L,67,67N,51,51N	21/87L/67/67N/51/51N	Overvoltage, SOTF, STUB,O/C, E/F, VT fuse fail, Directional O/C, Directional E/F, Broken Conductor, Distance etc.	Overvoltage, SOTF, STUB,O/C, E/F, VT fuse fail, Directional O/C, Directional E/F, Broken Conductor, Distance etc.	LBB INIT – R/Y/B PH LBB INIT – 3 PH LBB etc.
Mode of carrier aided scheme for 21 (If POR Scheme is used whether current reversal Guard logic implemented?)	Accelerated under reach/ Permissive under reach/ Intertripping under reach/ permissive under reach/ Blocking over reach/ Phase comparison protection (for PLCC)	N. A.	N. A.	-
Carrier aided scheme active for 67/67N		N. A.	N. A.	-
Mode of Carrier aided scheme for 67/67N	Directional comparison Protection (Permissive) / Directional Comparison Protection (Blocking)	N. A.	N. A.	-
For 87L which scheme is used? ( Pilot wire communication /digital communication)		Digital Communication (via OPGW)	Digital Communication (via OPGW)	
Power swing/out of step active?	Yes/No	No	No	
SOTF Active ?	Yes/No	Yes	Yes	
Auto reclose (79) active?	Yes/No	No	No	-
Breaker failure active	Yes/No	-	-	Yes

**Line Distance Protection - Check List (Interconnector 1 & 2)**

	Load Encroachment active	Yes/No	N. A.	N. A.	-
	Stub protection active	Yes/No	No	No	-
	Fault Locator active?	Yes/No	N. A.	N. A.	-
	Disturbance recorder active?	Yes/No	Yes	Yes	-
6	Relay connected to trip coil-1/Trip coil-2 or both?		Both	Both	Both
7	Feed from DC supply 1/DC supply-2		DC Supply 1	DC Supply 2	DC Supply 2
8	Connected to dedicated CT core? Define CT core no. to which the relay is connected		Core 1	Core 2	Core 2
9	CT ratio selected		2000/1	2000/1	3000/1
10	VT ratio selected		400kV/110V	400kV/110V	400kV/110V
11	VT Fuse failure protection	Yes/No	N. A.	N. A.	-
12	Overvoltage protection available	Yes/No	N. A.	N. A.	-
	Functional with two stage protection	Yes/No	N. A.	N. A.	-
13	Are all the auxiliary relays (94) considered for Line protection (Main-1/Main-2/Backup) provided with supervision Relays (74/94)?	Yes/No	Yes	Yes	-
14	Do the line protection panels have supervision relay for DC supply-1 and DC supply-2 (74/DC-1 & 74/DC2)?	Yes/No	Yes	Yes	-

**Transformer Protection Audit - Check list (GT 07)**

Audited data							
<b>No.</b>	<b>Relay configuration - Power Transformer Protection</b>						
1	Name, Voltage, Power rating		GT - 7, 21 kV / 420 kV, 3 X 275 MVA				
2	Are 2 groups of Protections used (Group A and Group B) for transformer Protection?	Yes/No	Yes				
3	Are Group A and Group B Protections connected to separate DC source for Power transformer	Yes/No	Yes				
4	Do the group A and Group B protections have separate Lockout relays?	Yes/No	Yes				
5	<b>Details of Type relay</b>		<b>Main-1</b>		<b>Main-2/Back up</b>		<b>Other Protections</b>
			<b>A</b>	<b>B</b>	<b>A</b>	<b>B</b>	
	Details of composite type Numerical relays						1. Overall Differential Protn. Relay 2. Overhang Diff. Protn. 3. LBB Protn. Etc.
	Relay Make and Model		Siemens 7UT63	Siemens 7SJ8022	Siemens 7UT63	Siemens 7SJ8022	1. SIPROTEC 7UT63 2. SIPROTEC 7UT61 3. SIPROTEC 7VK61
	whether the relay is functional	Yes/No	Yes	Yes	Yes	Yes	Yes
	Date of testing		January, 2017	January, 2017	January, 2017	January, 2017	January, 2017
	Mention all the active protection		Under frequency, GT SPR, PRV A, WTI etc.	HV REF	Buch, OTI, PRV B, GT FR	HV REF	Diff. R/Y/B ph TRIP Diff. Pick up LBB etc
	Differential protection		Yes		Yes		-

**Transformer Protection Audit - Check list (GT 07)**

	REF protection			Yes		Yes	-
	Backup Directional OC + EF Protection		Yes		Yes		-
	Over fluxing Protection		Yes		Yes		-
	Connected to trip coil 1/Trip coil 2/Both		Both	Both	Both	Both	Both
	feed from DC supply 1 Dc supply 2		DC Supply 1	DC Supply 1	DC Supply 2	DC Supply 2	DC Supply 2
	Breaker failure active	Yes/No	Yes	Yes	Yes	Yes	1.No 2.No 3.Yes
	Disturbance report active	Yes/No	Yes	Yes	Yes	Yes	Yes
	Connected to dedicated CT core? Define CT core no. to which the relay is connected		Core 1	Core 2	Core 1	Core 2	Core 2
	CT ratio selected	Yes/No	14000/5	1250/1	14000/5	1250/1	1.2000/1 2.2000/1 3.3000/1
	Is CT supervision enabled or not in case of Transformer differential protection ?	Yes/No	Yes	Yes	Yes	Yes	Yes
6	Are all the lockout relays (86) considered for Transformer protection provided with supervision relays (74/86) ?	Yes/No	Yes	Yes	Yes	Yes	Yes
7	Do the Transformer Protection panels have supervision relays for DC supply 1 and DC supply 2 (74/DC -1 & 74/DC-2) ?	Yes/No	Yes	Yes	Yes	Yes	Yes
8	OTI/WTI working	Yes/No	Yes		Yes		-
9	Bucholz / PRD working	Yes/No	Yes		Yes		-
10	LA rating on switchyard side	Yes/No	-	-	-	-	Yes, 360kV

**Transformer Protection Audit - Check list (GT-08)**

<b>Audited data</b>			
<b>No.</b>	<b>Relay configuration - Power Transformer Protection</b>		

**Transformer Protection Audit - Check list (GT-08)**

1	Name, Voltage, Power		GT - 8, 21kV/420 kV, 3 X 275 MVA				
2	Are 2 groups of Protections used (Group A and Group B) for transformer Protection?	Yes/No	Yes				
3	Are Group A and Group B Protections connected to separate DC source for Power transformer	Yes/No	Yes				
4	Do the group A and Group B protections have separate Lockout relays?	Yes/No	Yes				
5	<b>Details of Type relay</b>		<b>Main-1</b>		<b>Main-2/Back up</b>		<b>Other Protections</b>
			<b>A</b>	<b>B</b>	<b>A</b>	<b>B</b>	
	Details of composite type Numerical relays						1. Overall Differential Protn. Relay 2. Overhead Diff. Protn. 3. LBB Protn. Etc.
	Relay Make and Model		Siemens 7UT63	Siemens 7SJ8022	Siemens 7UT63	Siemens 7SJ8022	1. SIPROTEC 7UT63 2. SIPROTEC 7UT61 3. SIPROTEC 7VK61
	Whether the relay is functional	Yes/No	Yes	Yes	Yes	Yes	Yes
	Date of testing		2018	2018	2018	2018	2018
	Mention all the active protection		Under frequency, GT SPR, PRV A, WTI etc.	HV REF	Buch, OTI, PRV B, GT FR	HV REF	Diff. R/Y/B ph TRIP, Diff. Pick up, LBB etc
	Differential protection		Yes		Yes		-
	REF protection			Yes		Yes	-
	Backup Directional OC + EF Protection		Yes		Yes		-
	Over fluxing Protection		Yes		Yes		-

**Transformer Protection Audit - Check list (GT-08)**

	Connected to trip coil 1/Trip coil 2/Both		Both	Both	Both	Both	Both
	feed from DC supply 1 Dc supply 2		DC Supply 1	DC Supply 1	DC Supply 2	DC Supply 2	DC Supply 2
	Breaker failure active	Yes/No	Yes	Yes	Yes	Yes	1.No 2.No 3.Yes
	Disturbance report active	Yes/No	Yes	Yes	Yes	Yes	Yes
	Connected to dedicated CT core? Define CT core no. to which the relay is connected		Core 1	Core 2	Core 1	Core 2	Core 2
	CT ratio selected	Yes/No	14000/5	1250/1	14000/5	1250/1	1.2000/1 2.2000/1 3.3000/1
	Is CT supervision enabled or not in case of Transformer differential protection?	Yes/No	Yes	Yes	Yes	Yes	Yes
6	Are all the lockout relays (86) considered for Transformer protection provided with supervision relays (74/86) ?	Yes/No	Yes	Yes	Yes	Yes	Yes
7	Do the Transformer Protection panels have supervision relays for DC supply 1 and DC supply 2 (74/DC -1 & 74/DC-2) ?	Yes/No	Yes	Yes	Yes	Yes	Yes
8	OTI/WTI working	Yes/No	Yes		Yes		-
9	Bucholz / PRD working	Yes/No	Yes		Yes		-
10	LA rating on switchyard side	Yes/No	-	-	-	-	Yes, 360kV

**Synchro-Check Protection Audit Check list**

**Audited data**

Sr. No.	Relay configuration Synchro check protections		
Details of Relay			
1	Relay Make and Model		Alstom SKDIIBF80D3BCH
2	Whether the relay is functional	Yes/No	Yes
3	Date of testing		-

4	Voltage Measurement	P-P or P-N	P-N
5	What is the set value of voltage Difference ( $\Delta U$ ) ?	%	90%
6	What is the set value of Phase Angle Difference ( $\Delta\phi$ ) ?	°	35
7	What is the set value of frequency slip ( $\Delta f$ ) ?	mHz	0.08%
8	What is the time delay of output relay ? (DELAY)	sec	5
9	setting value for dead bus line	%	



**Shunt Reactor Protection - Checklist (Bikaner Line 1 Reactor)**

**Audited data**

No .	Relay configuration - Shunt Reactor Protections						
		1	Are 2 groups (Group A and Group B) used for Shunt Reactor protection?	Yes/No	Yes		
2	Are Group A and Group B protections connected to separate DC sources for shunt reactors?	Yes/No	Yes				
3	Do the Group A and Group B protections have separate lockout relays?	Yes/No	Yes				
4	<b>Details of type Relays</b>		<b>Main</b>		<b>Back-up</b>		<b>Other Protections</b>
			A	B	A	B	
	Details of composite type numerical relay						
	Relay Make and model		Siemens 7UT63	Siemens 7UT63	Siemens 7SA52		Siemens SIPROTEC 7VK61
	Whether the relay is functional?	Yes/No	Yes	Yes	Yes		Yes
	Date of testing		January, 2017	January, 2017	January, 2017		January, 2017
	Mention all the active protections			Buch. OTI, WTI	Backup Impedance		LBB Protn. etc
	Differential Protection		Yes	Yes	-		-
	REF Protection		Yes	-	-		-
	Back-up directional O/c + E/f protection				-		-
	Overfluxing protection				-		-
	Connected to Trip Coil 1/Trip Coil 2/Both		Both	Both	Both		Both
	Feed from DC supply 1/DC supply 2/Auto changeover		DC Supply 1	DC Supply 2	DC Supply 2		DC Supply 2
	Breaker Failure active	Yes/No					Yes
	Disturbance recorder active	Yes/No	Yes	Yes	Yes		YES
Connected to dedicated CT core? Define CT core no. to which the relay is connected		Core 2	Core 1	Core 3		Core 3	

**Shunt Reactor Protection - Checklist (Bikaner Line 1 Reactor)**

	CT ratio selected		3000/1	3000/1	200/1		200/1
	Is CT supervision enabled or not in case of Reactor Differential protection?	Yes/No	Yes	Yes	Yes		-
5	Are all the lock out relays (86) considered for reactor protection provided with supervision relays (74/86)?	Yes/No	Yes	Yes	Yes		Yes
6	Do the reactor protection panels have supervision relays for DC supply-1 & DC-supply-2 (74/DC-1 & 74/DC-2)?	Yes/No	Yes	Yes	Yes		Yes
7	OTI/WTI Indications working?	Yes/No	Yes	Yes	-		-
8	Buchholz / PRD working?	Yes/No	Yes	Yes	-		-
9	LA rating HV side?	Yes/No	Yes, 360KV				

**Shunt Reactor Protection - Checklist (Bikaner Line 2 Reactor)**

**Audited data**

No.	Relay configuration - Shunt Reactor Protections						
1	Are 2 groups (Group A and Group B) used for Shunt Reactor protection?	Yes/No	Yes				
2	Are Group A and Group B protections connected to separate DC sources for shunt reactors?	Yes/No	Yes				
3	Do the Group A and Group B protections have separate lockout relays?	Yes/No	Yes				
4	<b>Details of type Relays</b>		<b>Main</b>		<b>Back-up</b>		<b>Other Protections</b>
			<b>A</b>	<b>B</b>	<b>A</b>	<b>B</b>	
	Details of composite type numerical relay						
	Relay Make and model		Siemens 7UT63	Siemens 7UT63	Siemens 7SA52		Siemens SIPROTEC 7VK61
	Whether the relay is functional?	Yes/No	Yes	Yes	Yes		Yes
	Date of testing		January, 2017	January, 2017	January, 2017		January, 2017

**Shunt Reactor Protection - Checklist (Bikaner Line 2 Reactor)**

	Mention all the active protections			Buchhoiz ,OTI, WTI	Backup Impedance		LBB Protn. etc
	Differential Protection		Yes	Yes	-		-
	REF Protection		Yes	-	-		-
	Back-up directional O/c + E/f protection				-		-
	Overfluxing protection				-		-
	Connected to Trip Coil 1/Trip Coil 2/Both		Both	Both	Both		Both
	Feed from DC supply 1/DC supply 2/Auto changeover		DC Supply 1	DC Supply 2	DC Supply 2		DC Supply 2
	Breaker Failure active	Yes/No	No	No	No		Yes
	Disturbance recorder active	Yes/No	Yes	Yes	Yes		YES
	Connected to dedicated CT core? Define CT core no. to which the relay is connected		Core 2	Core 1	Core 3		Core 3
	CT ratio selected		3000/1	3000/1	200/1		200/1
	Is CT supervision enabled or not in case of Reactor Differential protection?	Yes/No	Yes	Yes	Yes		-
5	Are all the lock out relays (86) considered for reactor protection provided with supervision relays (74/86)?	Yes/No	Yes	Yes	Yes		YES
6	Do the reactor protection panels have supervision relays for DC supply-1 & DC-supply-2 (74/DC-1 & 74/DC-2)?	Yes/No	Yes	Yes	Yes		YES
7	OTI/WTI Indications working?	Yes/No	Yes	Yes	-		-
8	Buchholz / PRD working?	Yes/No	Yes	Yes	-		-
9	LA rating HV side?	Yes/No	Yes, 360KV				

**Bus Reactor 1 Protection**

**Audited data**

No.	Relay configuration - Shunt Reactor Protections	Yes/No		Yes			
		1	Are 2 groups (Group A and Group B) used for Shunt Reactor protection?	Yes/No		Yes	
2	Are Group A and Group B protections connected to separate DC sources for shunt reactors?	Yes/No		Yes			
3	Do the Group A and Group B protections have separate lockout relays?	Yes/No		Yes			
4	<b>Details of type Relays</b>		<b>Main</b>		<b>Back-up</b>		<b>Other Protections</b>
			<b>A</b>	<b>B</b>	<b>A</b>	<b>B</b>	
	Details of composite type numerical relay						
	Relay Make and model		Siemens 7UT63	Siemens 7UT63	Siemens 7SA52		Siemens SIPROTEC 7VK61
	Whether the relay is functional?	Yes/No	Yes	Yes	Yes		Yes
	Date of testing		February-2017	February-2017	February-2017		February, 2017
	Mention all the active protections			Buchhoiz ,OTI, WTI	Backup Impedance		LBB Protn. etc
	Differential Protection		Yes	Yes	-		-
	REF Protection		Yes	-	-		-
	Back-up directional O/c + E/f protection		No	No	-		-
	Overfluxing protection		No	No	-		-
	Connected to Trip Coil 1/Trip Coil 2/Both		Both	Both	Both		Both
	Feed from DC supply 1/DC supply 2/Auto changeover		DC Supply 1	DC Supply 2	DC Supply 2		DC Supply 2
	Breaker Failure active	Yes/No	No	No	No		Yes
	Disturbance recorder active	Yes/No	Yes	Yes	Yes		-
Connected to dedicated CT core? Define CT core no. to which the relay is connected		Core 6	Core 5	Core 3		Core 2	
CT ratio selected		500/1	500/1	200/1		3000/1	

**Bus Reactor 1 Protection**

	Is CT supervision enabled or not in case of Reactor Differential protection?	Yes/No	No	No	-	-
5	Are all the lock out relays (86) considered for reactor protection provided with supervision relays (74/86)?	Yes/No	Yes	yes	Yes	Yes
6	Do the reactor protection panels have supervision relays for DC supply-1 & DC-supply-2 (74/DC-1 & 74/DC-2)?	Yes/No	Yes	Yes	Yes	Yes
7	OTI/WTI Indications working?	Yes/No	Yes	Yes	-	-
8	Buchholz / PRD working?	Yes/No	Yes	Yes	-	-
9	LA rating HV side?	Yes/No	Yes, 360KV			

**Bus Reactor 2 Protection**

**Audited data**

No.	Relay configuration - Shunt Reactor Protections						
1	Are 2 groups (Group A and Group B) used for Shunt Reactor protection?	Yes/No	Yes				
2	Are Group A and Group B protections connected to separate DC sources for shunt reactors?	Yes/No	Yes				
3	Do the Group A and Group B protections have separate lockout relays?	Yes/No	Yes				
4	<b>Details of type Relays</b>		<b>Main</b>		<b>Back-up</b>		<b>Other Protections</b>
			<b>A</b>	<b>B</b>	<b>A</b>	<b>B</b>	
	Details of composite type numerical relay						
	Relay Make and model		Siemens 7UT63	Siemens 7UT63	Siemens 7SA52		Siemens SIPROTEC 7VK61
	Whether the relay is functional?	Yes/No	Yes	Yes	Yes		Yes
Date of testing		January, 2017	January, 2017	January, 2017		February, 2017	

**Bus Reactor 2 Protection**

	Mention all the active protections			Buchhoiz ,OTI, WTI	Backup Impedance		LBB Protn. etc	
	Differential Protection		Yes	Yes	-		-	
	REF Protection		Yes	-	-		-	
	Back-up directional O/c + E/f protection		No	No	-		-	
	Overfluxing protection		No	No	-		-	
	Connected to Trip Coil 1/Trip Coil 2/Both		Both	Both	Both		Both	
	Feed from DC supply 1/DC supply 2/Auto changeover		DC Supply 1	DC Supply 2	DC Supply 2		DC Supply 2	
	Breaker Failure active	Yes/No	No	No	No		Yes	
	Disturbance recorder active	Yes/No	Yes	Yes	Yes		-	
	Connected to dedicated CT core? Define CT core no. to which the relay is connected		Core 6	Core 5	Core 3		Core 2	
	CT ratio selected		500/1	500/1	200/1		3000/1	
	Is CT supervision enabled or not in case of Reactor Differential protection?	Yes/No	No	No	-		-	
5	Are all the lock out relays (86) considered for reactor protection provided with supervision relays (74/86)?	Yes/No	Yes	Yes	Yes		Yes	
6	Do the reactor protection panels have supervision relays for DC supply-1 & DC-supply-2 (74/DC-1 & 74/DC-2)?	Yes/No	Yes	Yes	Yes		Yes	
7	OTI/WTI Indications working?	Yes/No	Yes	Yes	-		-	
8	Buchholz / PRD working?	Yes/No	Yes	Yes	-		-	
9	LA rating HV side?	Yes/No	Yes, 360KV					

**Shunt Reactor Protection - Checklist (Babai Line 1 Reactor)**

**Audited data**

No.	Relay configuration - Shunt Reactor Protections						
		1	Are 2 groups (Group A and Group B) used for Shunt Reactor protection?	Yes/No	Yes		
2	Are Group A and Group B protections connected to separate DC sources for shunt reactors?	Yes/No	Yes				
3	Do the Group A and Group B protections have separate lockout relays?	Yes/No	Yes				
4	<b>Details of type Relays</b>		<b>Main</b>		<b>Back-up</b>		<b>Other Protections</b>
			<b>A</b>	<b>B</b>	<b>A</b>	<b>B</b>	
	Details of composite type numerical relay		Yes	Yes	Yes		
	Relay Make and model		Siemens 7UT63	Siemens 7UT63	Siemens 7SA52		Siemens SIPROTEC 7VK61
	Whether the relay is functional?	Yes/No	Yes	Yes	Yes		Yes
	Date of testing		January, 2017	January, 2017	January, 2017		January, 2017
	Mention all the active protections			Buchhoiz ,OTI, WTI	Backup Impedance		LBB Protn. etc
	Differential Protection		Yes	Yes	-		-
	REF Protection		Yes	-	-		-
	Back-up directional O/c + E/f protection		No	No	-		-
	Overfluxing protection		No	No	-		-
	Connected to Trip Coil 1/Trip Coil 2/Both		Both	Both	Both		both
	Feed from DC supply 1/DC supply 2/Auto changeover		DC Supply 1	DC Supply 2	DC Supply 2		DC Supply 2
	Breaker Failure active	Yes/No	No	No	No		Yes
	Disturbance recorder active	Yes/No	Yes	Yes	Yes		YES
Connected to dedicated CT core? Define CT core no. to which the relay is connected		Core 2	Core 1	Core 3		Core 2	
CT ratio selected		3000/1	3000/1	200/1		200/1	

**Shunt Reactor Protection - Checklist (Babai Line 1 Reactor)**

	Is CT supervision enabled or not in case of Reactor Differential protection?	Yes/No	Yes	Yes	Yes		-	
5	Are all the lock out relays (86) considered for reactor protection provided with supervision relays (74/86)?	Yes/No	Yes	Yes	Yes		YES	
6	Do the reactor protection panels have supervision relays for DC supply-1 & DC-supply-2 (74/DC-1 & 74/DC-2)?	Yes/No	Yes	Yes	Yes		YES	
7	OTI/WTI Indications working?	Yes/No	Yes	Yes	-		-	
8	Buchholz / PRD working?	Yes/No	Yes	Yes	-		-	
9	LA rating HV side?	Yes/No	Yes, 360KV					

**Shunt Reactor Protection - Checklist (Babai Line 2 Reactor)**

**Audited data**

No.	Relay configuration - Shunt Reactor Protections						
1	Are 2 groups (Group A and Group B) used for Shunt Reactor protection?	Yes/No			Yes		
2	Are Group A and Group B protections connected to separate DC sources for shunt reactors?	Yes/No			Yes		
3	Do the Group A and Group B protections have separate lockout relays?	Yes/No			Yes		
4	<b>Details of type Relays</b>		<b>Main</b>		<b>Back-up</b>		<b>Other Protections</b>
			<b>A</b>	<b>B</b>	<b>A</b>	<b>B</b>	
	Details of composite type numerical relay		Yes	Yes	Yes		
	Relay Make and model		Siemens 7UT63	Siemens 7UT63	Siemens 7SA52		Siemens SIPROTEC 7VK61
	Whether the relay is functional?	Yes/No	Yes	Yes	Yes		Yes
Date of testing		March-2017	March-2017	March-2017		January, 2017	



**Shunt Reactor Protection - Checklist (Babai Line 2 Reactor)**

	Mention all the active protections			Buchhoiz ,OTI, WTI	Backup Impedance		LBB Protn. etc	
	Differential Protection		Yes	Yes	-		-	
	REF Protection		Yes	-	-		-	
	Back-up directional O/c + E/f protection		No	No	-		-	
	Overfluxing protection		No	No	-		-	
	Connected to Trip Coil 1/Trip Coil 2/Both		Both	Both	Both		Both	
	Feed from DC supply 1/DC supply 2/Auto changeover		DC Supply 1	DC Supply 2	DC Supply 2		DC Supply 2	
	Breaker Failure active	Yes/No					Yes	
	Disturbance recorder active	Yes/No	Yes	Yes	Yes		Yes	
	Connected to dedicated CT core? Define CT core no. to which the relay is connected		Core 2	Core 1	Core 3		Core 2	
	CT ratio selected		3000/1	3000/1	200/1		200/1	
	Is CT supervision enabled or not in case of Reactor Differential protection?	Yes/No	Yes	Yes	Yes		-	
5	Are all the lock out relays (86) considered for reactor protection provided with supervision relays (74/86)?	Yes/No	Yes	Yes	Yes		YES	
6	Do the reactor protection panels have supervision relays for DC supply-1 & DC-supply-2 (74/DC-1 & 74/DC-2)?	Yes/No	Yes	Yes	Yes		YES	
7	OTI/WTI Indications working?	Yes/No	Yes	Yes	-		-	
8	Buchholz / PRD working?	Yes/No	Yes	Yes	-		-	
9	LA rating HV side?	Yes/No	Yes, 360KV					

<b>Details of Bus-bar Protection System</b>				
<b>BB and BF Protection</b>		<b>400 kV</b>		
<b>BUSBAR PROTECTION</b>				
1	Main BB available or not?	Yes / No	Yes	
2	Back-up busbar protection to be provided by either of the following:			
	- Remote end distance relay overreaching elements (second zone)	Yes / No	Yes	
	- Reverse looking element of the local distance relay	Yes / No	Yes	
	- Directional back-up overcurrent relays at remote end	Yes / No	Yes	
3	Redundant BBP available or not?	Yes / No	Yes	
4	Type of Bus Bar arrangement: 1 and 1/2 breaker scheme/ Single Busbar/ Double Busbar/ Main-1, Main-2 and Transfer		1 and 2 breaker scheme	
			<b>Busbar 1 (BB1)</b>	<b>Busbar 2 (BB2)</b>
5	Main 1 Relay Make		SIPROTEC 7SS85 Siemens	SIPROTEC 7SS85 Siemens
	Main 1 Relay Functional?	Yes / No	Yes	Yes
	Main 1 Relay Type	Low / High Impedance	Low Impedance	Low Impedance
	Connected to Trip Coil 1 / Trip Coil 2		Both	Both
	Feed from DC Supply 1 / DC Supply 2		DC Supply 1	DC Supply 1
6	Main 2 Relay Make		Siemens 7SS85	Siemens 7SS85
	Main 2 Relay Functional?	Yes / No	Yes	Yes
	Main 2 Relay Type	Low / High Impedance	Low Impedance	Low Impedance
	Connected to Trip Coil 1 / Trip Coil 2		Both	Both
	Feed from DC Supply 1 / DC Supply 2		DC Supply 2	DC Supply 2

Details of Bus-bar Protection System						
7	Trip to both coils in case of one BBP	Yes / No	Yes		Yes	
			<b>BB1Main -1</b>	<b>BB1Main -2</b>	<b>BB2Main -1</b>	<b>BB2Main -2</b>
8	Dedicated CT core for each BB protection	Yes / No	Yes	Yes	Yes	Yes
9	<i>For High Impedance Busbar Protection</i>					
	a) Is the high impedance protection used for simple busbar arrangement like 1 and 1/2 breaker scheme or single busbar arrangement?	Yes / No	No	No	No	No
	b) Whether the CT ratios and characteristics are same ( $V_k$ etc.)	Yes / No	No	No	No	No
	c) Whether stability check has been conducted?	Yes / No	No	No	No	No
	d) Is CT supervision relay provided or not?	Yes / No	No	No	No	No
	e) In case of busbar protection where CT selection contacts are used for zone selectivity / CT selection, please fill below items:					
	- Is check zone enabled or not?	Yes / No	No	No	No	No
	- Is check zone measurement connected to separate CT cores?	Yes / No	No	No	No	No
	- If check zone is not enabled, is the relay setting increased to value higher than the heaviest loaded feeder current?	Yes / No	No	No	No	No
10	<i>For Low Impedance Busbar Protection</i>					
	a) Centralized BBP	Yes / No	Yes	Yes	Yes	Yes
	b) Or decentralized BBP with peripheral units	Yes / No				
	c) Whether stability check has been conducted?	Yes / No	Yes	Yes	Yes	Yes
	d) Is CT supervision enabled or not?	Yes / No	Yes	Yes	Yes	Yes
10	e) In case of busbar protection where CT selection contacts are used for zone selectivity / CT					

Details of Bus-bar Protection System						
	selection, please fill below items:					
	- Is checkzone enabled or not?	Yes / No	Yes	Yes	Yes	Yes
	- If check zone is not enabled, is the relay setting increased to value higher than the heaviest loaded feeder current?	Yes / No				
11	One zone for one bus	Yes / No	Yes			
12	Are all the Busbar protection Lockout relays (86 BB) provided with supervision relays (74 / 86BB) ?	Yes / No	Yes			
13	Do all the busbar protection panels have supervision relays for DC supply-1 and DC supply-2 (74/DC-1 & 74 DC-2) ?	Yes / No	Yes			
	<b>BREAKER FAILURE PROTECTION</b>					
14	Breaker failure included in BB protection	Yes / No	No			
15	Breaker failure included in Line/Transformer protection	Yes / No	No			
16	Separate BFP provided	Yes / No	Yes			
17	If separate BFP is provided, furnish Make/model	Yes / No	Yes Siemens 7VK61			
18	BFP relay functional	Yes / No	Yes			
19	BFP conditions: Current presence	Yes / No	Yes			
20	BFP conditions: CB closed position	Yes / No	Yes			
21	BFP retrip active (first stage)	Yes / No	Yes			
22	Tripping time for BFP (second stage) $0.2\text{ s} < t < 0.3\text{ s}$	Yes / No	0.2 S			
23	Are Breaker Failure protection auxiliary relay for Stage-1 (94BF) and Lock out relay for Stage-2 (86BF) provided with supervision relays (74/94BF & 74/86BF)	Yes / No	Yes			
24	Do all the Breaker Failure protection panels have supervision relays for DC Supply-1 & DC Supply-2 (74/DC-1 and 74/DC-2)	Yes / No	Yes			

Details of CVT / CC / PT

Sr. No.	Feeder Name	CVT / CC / PT	Phase	Make	Serial No.	Prot. / Met	Capacitance / Ratio	Ratio	Standard	Accuracy Class		Win-1 & 2 Burden (VA)	Win-3 & 4 Burden (VA)	Connected to Which relays	Relay setting calc. and configuration files based on VT Ratio? (For VTs connected to Distance prot. / synchro check relays)	For Synchrocheck relays, VT l/p connected Ph-Ph OR Ph-N (Which Phase?)	Date of Commissioning
										Core-1 Core-2	Core-3 Core-4						
1	Y1 IC 1	CVT	R	BHEL	6192039	Both	4400 pF	400kV/v3/110 v/ v3	IS:3156	3P	0.2	30	15	BCU/CP	NA	R-N	2016
		CVT	Y	BHEL	6192040	Both	4400 pF	400kV/v3/110 v/ v3	IS:3156	3P	0.2	30	15	BCU/CP	NA	R-N	2016
		CVT	B	BHEL	6192041	Both	4400 pF	400kV/v3/110 v/ v3	IS:3156	3P	0.2	30	15	BCU/CP	NA	R-N	2016
2	Y2 IC 2	CVT	R	BHEL	6192042	Both	4400 pF	400kV/v3/110 v/ v3	IS:3156	3P	0.2	30	15	BCU/CP	NA	R-N	2016
		CVT	Y	BHEL	6192043	Both	4400 pF	400kV/v3/110 v/ v3	IS:3156	3P	0.2	30	15	BCU/CP	NA	R-N	2016
		CVT	B	BHEL	6192044	Both	4400 pF	400kV/v3/110 v/ v3	IS:3156	3P	0.2	30	15	BCU/CP	NA	R-N	2016
3	Y3 BABAI 1	CVT	R	BHEL	6194262	Both	4400 pF	400kV/v3/110 v/ v3	IS:3156	3P	0.2	30	15	BCU/CP/21M1/M2	Only Bay Commissioned & Line Not Erected	R-N	2023
		CVT	Y	BHEL	6192048	Both	4400 pF	400kV/v3/110 v/ v3	IS:3156	3P	0.2	30	15	BCU/CP/21M1/M2		R-N	2023
		CVT	B	BHEL	6194264	Both	4400 pF	400kV/v3/110 v/ v3	IS:3156	3P	0.2	30	15	BCU/CP/21M1/M2		R-N	2023
4	Y6 BABAI 2	CVT	R	BHEL	6192025	Both	4400 pF	400kV/v3/110 v/ v3	IS:3156	3P	0.2	30	15	BCU/CP/21M1/M2	Only Bay Commissioned & Line Not Erected	R-N	2023
		CVT	Y	BHEL	6194263	Both	4400 pF	400kV/v3/110 v/ v3	IS:3156	3P	0.2	30	15	BCU/CP/21M1/M2		R-N	2023
		CVT	B	BHEL	6194257	Both	4400 pF	400kV/v3/110 v/ v3	IS:3156	3P	0.2	30	15	BCU/CP/21M1/M2		R-N	2023
5	Y9 BIKANER 1	CVT	R	BHEL	6194256	Both	4400 pF	400kV/v3/110 v/ v3	IS:3156	3P	0.2	30	15	BCU/CP/21M1/M2	Attached	R-N	2017
		CVT	Y	BHEL	6194259	Both	4400 pF	400kV/v3/110 v/ v3	IS:3156	3P	0.2	30	15	BCU/CP/21M1/M2	Attached	R-N	2017
		CVT	B	BHEL	6197230	Both	4400 pF	400kV/v3/110 v/ v3	IS:3156	3P	0.2	30	15	BCU/CP/21M1/M2	Attached	R-N	2017
6	Y10 BIKANER 2	CVT	R	BHEL	6194266	Both	4400 pF	400kV/v3/110 v/ v3	IS:3156	3P	0.2	30	15	BCU/CP/21M1/M2	Attached	R-N	2017
		CVT	Y	BHEL	6194258	Both	4400 pF	400kV/v3/110 v/ v3	IS:3156	3P	0.2	30	15	BCU/CP/21M1/M2	Attached	R-N	2017
		CVT	B	BHEL	6192029	Both	4400 pF	400kV/v3/110 v/ v3	IS:3156	3P	0.2	30	15	BCU/CP/21M1/M2	Attached	R-N	2017
7	Y7 GT 07	CVT	R	BHEL	6192036	Both	4400 pF	400kV/v3/110 v/ v3	IS:3156	3P	0.2	30	15	BCU/CP	NA	R-N	2016
		CVT	Y	BHEL	6192037	Both	4400 pF	400kV/v3/110 v/ v3	IS:3156	3P	0.2	30	15	BCU/CP	NA	R-N	2016
		CVT	B	BHEL	6192038	Both	4400 pF	400kV/v3/110 v/ v3	IS:3156	3P	0.2	30	15	BCU/CP	NA	R-N	2016
8	BUS 02	CVT	R	BHEL	6192033	Both	4400 pF	400kV/v3/110 v/ v3	IS:3156	3P	0.2	30	15	BCU/CP/21R	NA	R-N	2016
		CVT	Y	BHEL	6192034	Both	4400 pF	400kV/v3/110 v/ v3	IS:3156	3P	0.2	30	15	BCU/CP/21R	NA	R-N	2016
		CVT	B	BHEL	6192035	Both	4400 pF	400kV/v3/110 v/ v3	IS:3156	3P	0.2	30	15	BCU/CP/21R	NA	R-N	2016
9	BUS 01	CVT	R	BHEL	6192030	Both	4400 pF	400kV/v3/110 v/ v3	IS:3156	3P	0.2	30	15	BCU/CP/21R	NA	R-N	2017
		CVT	Y	BHEL	6192031	Both	4400 pF	400kV/v3/110 v/ v3	IS:3156	3P	0.2	30	15	BCU/CP/21R	NA	R-N	2017
		CVT	B	BHEL	6192032	Both	4400 pF	400kV/v3/110 v/ v3	IS:3156	3P	0.2	30	15	BCU/CP/21R	NA	R-N	2017
10	Y12 GT 08	CVT	R	BHEL	6194261	Both	4400 pF	400kV/v3/110 v/ v3	IS:3156	3P	0.2	30	15	BCU/CP	NA	R-N	2017
		CVT	Y	BHEL	6192028	Both	4400 pF	400kV/v3/110 v/ v3	IS:3156	3P	0.2	30	15	BCU/CP	NA	R-N	2017
		CVT	B	BHEL	6194265	Both	4400 pF	400kV/v3/110 v/ v3	IS:3156	3P	0.2	30	15	BCU/CP	NA	R-N	2017

Details of Circuit Breaker

Sr. No.	Parameter / Details	1	2	3	4	5	6	7	8	9	10	11	12	13	14	15	16	17	18	19
1	Feeder / Bay Name	IC-1	IC-2	BABAI TIE	BABAI -1 REACTOR	BABAI -2 REACTOR	BIKANE R-1 RECTOR	BIKANE R-2 REACTOR	BIKANER TIE	Bikaner-2	Bikaner-1	Babai-2	Babai-1	Bus-1 Reactor	Bus-1 & 2 Reactor Tie	Bus-2 Reactor	GT-07	GT-07 Tie	GT-08 Tie	GT-08
2	CB Rated Voltage in kV	420	420	420	420	420	420	420	420	420	420	420	420	420	420	420	420	420	420	420
3	Type of CB	400-SFM-40A	400-SFM-40A	400-SFM-40A	400-SFM-40A	400-SFM-40A	400-SFM-40A	400-SFM-40A	400-SFM-40A	400-SFM-40A	400-SFM-40A	400-SFM-40A	400-SFM-40A	400-SFM-40A	400-SFM-40A	400-SFM-40A	400-SFM-40A	400-SFM-40A	400-SFM-40A	400-SFM-40A
4	Breaker Healthy? (Yes / No)	Yes	Yes	Yes	Yes	Yes	Yes	Yes	Yes	Yes	Yes	Yes	Yes	Yes	Yes	Yes	Yes	Yes	Yes	Yes
5	Continuous Rated Current	40kA	40kA	40kA	40kA	40kA	40kA	40kA	40kA	40kA	40kA	40kA	40kA	40kA	40kA	40kA	40kA	40kA	40kA	40kA
6	Rated Breaking Current (kA)	50kA	50kA	50kA	50kA	50kA	50kA	50kA	50kA	50kA	50kA	50kA	50kA	50kA	50kA	50kA	50kA	50kA	50kA	50kA
7	Number of Closing Coils	1	1	1	1	1	1	1	1	1	1	1	1	1	1	1	1	1	1	1
8	Healthiness of Closing Coils	OK	OK	OK	OK	OK	OK	OK	OK	OK	OK	OK	OK	OK	OK	OK	OK	OK	OK	OK
9	Number of Tripping Coils	2	2	2	2	2	2	2	2	2	2	2	2	2	2	2	2	2	2	2
10	Healthiness of Tripping Coils	OK	OK	OK	OK	OK	OK	OK	OK	OK	OK	OK	OK	OK	OK	OK	OK	OK	OK	OK
11	Trip circuit supervision relay available for monitoring Trip Circuit-1 & Trip Circuit-2 with breaker in both open and closed condition (Yes / No)	Yes	Yes	Yes	Yes	Yes	Yes	Yes	Yes	Yes	Yes	Yes	Yes	Yes	Yes	Yes	Yes	Yes	Yes	Yes
12	Are the trip circuit supervision relays healthy?	Yes	Yes	Yes	Yes	Yes	Yes	Yes	Yes	Yes	Yes	Yes	Yes	Yes	Yes	Yes	Yes	Yes	Yes	Yes
13	One / Three Pole Operation	Three	Three	Three	Three	Three	Three	Three	Three	Three	Three	Three	Three	Three	Three	Three	Three	Three	Three	Three
14	For breakers with three poles, is pole discrepancy relay provided?	Yes	Yes	Yes	Yes	Yes	Yes	Yes	Yes	Yes	Yes	Yes	Yes	Yes	Yes	Yes	Yes	Yes	Yes	Yes
15	Does the pole discrepancy relay have facility for Stage-1 (own breaker tripping) & Stage-2 (Boundary breaker tripping)	Yes	Yes	Yes	Yes	Yes	Yes	Yes	Yes	Yes	Yes	Yes	Yes	Yes	Yes	Yes	Yes	Yes	Yes	Yes
16	What monitoring devices are provided for checking the dielectric medium of the breaker? (e.g. Gas Pressure Low etc.)	Yes	Yes	Yes	Yes	Yes	Yes	Yes	Yes	Yes	Yes	Yes	Yes	Yes	Yes	Yes	Yes	Yes	Yes	Yes
17	What action is initiated by each of different Stages of these devices (Alarm / Block Tripping)	Alarm	Alarm	Alarm	Alarm	Alarm	Alarm	Alarm	Alarm	Alarm	Alarm	Alarm	Alarm	Alarm	Alarm	Alarm	Alarm	Alarm	Alarm	Alarm
18	PIR (Available / Not)?	No	No	Yes	No	No	No	No	Yes	Yes	Yes	Yes	Yes	No	No	No	No	No	No	Yes

<b>Details of Communication System</b>				
<b>No.</b>	<b>No.</b>	<b>Communication System</b>		<b>400 kV</b>
1	a	Type of Communication for Main-1 Protection	PLCC / OPGW	Both OPGW & PLCC
	b	Type of Communication for Main-2 Protection	PLCC / OPGW	Both OPGW & PLCC
	c	Mode used for Data Communication	Mono / Bi Directional	Bi Directional
	d	Mode used for Speech Communication		Both OPGW & PLCC
2	<b>PLCC Details</b>			
	a	Do you use PLL for teleprotection of Distance relays	Yes / No	Yes
	b	Specify type of coupling	Ph-Ph/ Ph-G/ Inter-circuit	Ph-Ph
	c	Whether redundant PLCC channels provided for 400 kV and 765 kV lines	Yes / No	Yes
	d	Specify number of PLCC channels per circuit	One / Two	Two
	e	No. of protection channels No. of data channels No. of speech channels		Two Two Two
	f	Whether dependability & security of each tele-protection channel measured and record kept?	Yes / No	No
	g	Is the PLCC equipment and channels healthy & functional	Yes / No	Yes
3	<b>OPGW Details</b>			
	a	Redundancy maintained by providing two sets of Fibre optic Equipment	Yes / No	No
	b	Card level redundancy (Power supply card, protection card, CPU board) maintained in each fibre of optic equipment	Yes / No	No
	c	Separate DC battery supply or common DC battery supply separately fused for each fibre optic equipment	Yes / No	Yes
	d	Are the Fibre Optic equipment and channels healthy & functional	Yes / No	Yes
4	<b>Time Synchronization Equipment Details</b>			
	a	Whether GPS based time synchronizing equipment is provided at the substation for time synchronizing of Main Relays/ DR/ Event Logger/ SAS/ PMU/ Line Current Differential Relays	Yes / No	Yes

<b>Details of Communication System</b>				
<b>No.</b>	<b>No.</b>	<b>Communication System</b>		<b>400 kV</b>
	b	Are Time Synchronization Equipment (TSE) complete with antenna, all cables, processing equipments etc. provided to receive synchronizing pulse through Global Positioning System (GPS) compatible for synchronization of event logger, disturbance recorder and SCADA/ automation system.	Yes / No	Yes
	c	Are the Main Relays/ DR/ Event Logger/ SAS/ PMU/ Line current differential relays time synchronized?	Yes / No	Yes
5	<b>Disturbance Recorder (DR) and Event Logger (EL) Details</b>			
	a	Is DR provided on all feeders?	Yes / No	Yes
	b	Is the Fault locator provided on all line feeders?	Yes / No	Yes
	c	Whether DR is standalone or part of main relay?	Yes / No	Yes
	d	Whether DR functional?	Yes / No	No
	e	Whether DR is having automatic fault record download facility to a central PC?	Yes / No	No
	f	Whether substation is having EL facility?	Standalone / Built-in SAS	Built-in SAS
	g	EL functional?	Yes / No	Yes



**Details of Plant AC Supply System**

No.	AC Supply System		Supply - 1
1	Source of AC HT Supplies	Name of Source	ST 07 & ST 08
	In case of two AC HT supplies, the supplies are arranged from independent sources	Yes / No	Yes
	Voltage of supply		11kV
	Supply changeover method between Supply 1 & 2	Auto / Manual	Bus Coupler
2	<b>DG</b>		
	DG Available?	Yes / No	Yes
	Make and Rating		3 X 1750 kVA (Super Nova)
	What loads are supplied by DG?		Emergency MCC (EMCC), 6 - DC motors (JOP, EOP, SOP, TDBFP-EOPs, Scanner fan etc.)
	Starting operation and sequence Automatic / Manual?		Automatic
	Supply changeover method between Normal AC supply and DG	Auto / Manual	Auto
3	The SS to furnish the supply changeover scheme / SLD		N.A.
4	<b>Maintenance / Testing Plan</b>		
	What is maintenance plan/ schedule followed by the utility for maintenance of DG?		Maintenance is to be done according to the requirement i. e. daily, routine and preventive etc.
5	Remark		

Details of DC System						
No .	DC Supply Systems		Voltage - 220 V	Voltage - 220 V	Voltage - 48 V	Voltage - 48 V
1	Type of Batteries		Exide YHP 15	Exide YHP 15	Exide YHP 13	Exide YHP 13
2	Number of Cells per bank		108	108	24	24
3	Date of procurement / commissioning of Battery Bank					
4	Is the Battery functional and in Good Condition?	Yes / No	Yes	Yes	Yes	Yes
5	Availability of Battery Charger	Yes / No	Yes	Yes	Yes	Yes
6	Date of procurement / commissioning of the charger					
7	Is the charger functional?	Yes / No	Yes	Yes	Yes	Yes
8	Used combination of charging	(a) Two sets of Battery and charger, (b) Single battery with charger, (c) One battery with two chargers	Two sets of Battery and Charger	Two sets of Battery and Charger	Two sets of Battery and Charger	Two sets of Battery and Charger
9	Measure Voltage at Farthest Panel		243.8 V	243.8 V	53.1 V	53.4 V
	Positive to Earth		119.57 V	119.3 V	0 V	0 V
	Negative to Earth		124.24 V	124.7 V	53.1 V	53.4 V
10	Availability of Battery Ground Fault Detectors?	Yes / No	Yes	Yes	Yes	Yes
11	The protection relays and trip circuits are segregated into two independent system feed through fuses from Two different sources?	Yes / No	Yes	Yes	Yes	Yes
12	Maintenance / Testing Plan					
	What is maintenance plan/ schedule followed by the utility for maintenance of battery and charger?		Maintenance is to be done according to the requirement i. e. daily, routine and preventive etc.			

Lightning Arrester									
Sl. No.	Feeder Name	Physical Check and damages in the porcelain skirt	Earthing of Counter	Leakage Current of LA (in mA)			Counter Reading		
				RΦ	YΦ	BΦ	RΦ	YΦ	BΦ
1	Interconnector- 1	OK	Yes	0.85	0.8	0.8	41	17	17
2	Interconnector- 2	OK	Yes	0	0.8	0.6	9	8	9
3	Babai Line-1	OK	Yes	0.6	0.8	0.8	8	10	7
4	Babai Line- 1 Reactor	OK	Yes	0.9	0.8	0.8	8	8	10
5	Babai Line- 2	OK	Yes	0.8	0.7	0.9	8	9	13
6	Babai Line- 2 Reactor	OK	Yes	0.7	0.9	0.8	9	10	9
7	Bikaner Line 1 Reactor	OK	Yes	0.85	0.85	0.7	7	9	10
8	Bikaner Line 1	OK	Yes	0.85	0.75	0.8	8	7	8
9	Bikaner Line 2	OK	Yes	0.85	0.8	0.8	8	13	7
10	Bikaner Line 2 Reactor	OK	Yes	0.95	0.8	0.75	8	9	9
11	Bus Reactor- 1	OK	Yes	0.9	0.8	0.8	11	19	8
12	Bus Reactor- 2	OK	Yes	0.3	0.3	0.3	7	7	8

Sr. No	Particular	Available (Yes/NO)	Verification done (Yes/NO)	Detail of SPS Scheme						Remark
1	Special protection scheme	NO	---	Scheme not finalized as this has to be finalized by RRVUNL.						---
2	Status of corrective actions based on tripping analysis	---	---	--	---	---	---	---	---	---

3	Any othe observations /comments	---	---	-- -	---	---	---	---	---	---
---	---------------------------------	-----	-----	---------	-----	-----	-----	-----	-----	-----

### CHECK-LIST

Check list for different protected objects & elements in fault clearance system are as under:

#### **A. Transmission Lines (OHL and Cables)**

1	Independent Main-I and Main-II protection (of different make OR different type) is provided with carrier aided scheme	Yes
2	Are the Main-I & Main-II relays connected to two separate DC sources (Group-A and Group-B)	Yes
3	Is the Distance protection (Non-switched type, suitable for 1-ph & 3- ph tripping) as Main1 and Main2 provided to ensure selectivity & reliability for all faults in the shortest possible time	Yes
4	Is both main-I & Main-II distance relay are numerical design having Quadrilateral or Polygon operating characteristic	Yes
5	In the Main-I / Main-II Distance protection, Zone-I is set cover 80% of the protected line section	Yes
6	In the Main-I / Main-II distance protection, Zone-2 is set cover 120% of the protected line section in case of Single circuit line and 150% in case of Double circuit line	Yes (100% OF PL + 50% OF ASL)
7	In the Main-I / Main-II distance protection, Zone-3 is set cover 120% of the total of protected line section plus longest line at remote end as a minimum.	Yes
8	Resistive reach for Ground fault element set to give maximum coverage considering fault resistance, arc resistance & tower footing resistance. (In case, it is not possible to set the ground fault and phase fault reaches separately, load point encroachment condition imposed on Phase fault resistive reach shall be applied)	Yes
9	Resistive reach for Phase fault element set to give maximum coverage subject to check of possibility against load point encroachment considering minimum expected voltage and maximum load.	Yes
10	In case of short lines, is manufacturers recommendation considered in respect of resistive setting vis a vis reactance setting to avoid overreach.	N.A.
11	Is Zone-2 time delay of Main-I / Main-II distance relay set to 0.350 seconds?  In case any other value has been set for Zone-II timer, kindly specify the value and justification thereof.	0.4 S  Settings recommended by M/s. BHEL
12	Is Zone-3 timer is set to provide discrimination with the operating time of relays at adjacent sections with which Zone-3 reach of relay is set to overlap. Please specify the Zone-3 time set.	Yes 1 S
13	Is Zone-4 reach set in reverse direction to cover expected levels of apparent bus bar	Yes

	fault resistance, when allowing for multiple in feeds from other circuits?	
14	Is reverse looking Zone-4 time delay set as Zone-2 time delay?	NO
15	Is Switch on to fault (SOTF) function provided in distance relay to take care of line energization on fault?  Whether SOTF initiation has been implemented using hardwire logic In case of Breaker and half switching scheme,  whether initiation of line SOTF from CB closing has been interlocked with the other CB	Yes  IN BUILT IN RELAY  Yes (MAIN & TIE BREAKER)
16	Whether VT fuse fail detection function has been correctly set to block the distance function operation on VT fuse failure	Yes
17	Is the sensitive IDMT directional E/F relay (either separate relay or built-in function of Main relay) for protection against high resistive earth faults?	Yes (DT settings provided)
18	Is additional element (Back-up distance) for remote back-up protection function provided in case of unit protection is used as Main relay for lines?	Yes
19	In case of Cables, is unit protection provided as Main-I & Main-II protection with distance as back-up.	N. A.
20	Are the line parameters used for setting the relay verified by field testing	Yes
21	Is Two stages Over-Voltage protection provided for 765 & 400kV Lines? Do you apply grading in over-voltage setting for lines at one station. Please specify the setting values adopted for:  Stage-I :  Stage-II:	Yes  Yes  110%  130%
22	Is 1-ph Auto - reclosing provided on 765, 400 & 220kV lines? Please specify the set value:  Dead time:  Reclaim time:	Yes  1 S  25 S
23	Is the Distance communication. Scheme Permissive Over Reach (POR) applied for short lines and Permissive Under Reach (PUR) applied for long lines?  If any other communication scheme has been applied, please provide the detail with justification thereof.	Permissive Under Reach (PUR)  N. A.
24	Is the Current Reversal Guard logic for POR scheme provided on Double circuit lines?	N. A.
25	In case the protected line is getting terminated at a station having very low fault level i.e. HVDC terminal, whether week end-infeed feature has been enabled in respective distance relay or not	N. A.

26	In case of protected line is originating from nuclear power station, are the special requirement (stability of nuclear plant auxiliaries) as required by them has been met	N. A.
27	What line current, Voltage and Load angle have been considered for Load encroachment blinder setting and what is the resultant MVA that the line can carry without load encroachment. (In the absence of Load encroachment blinder function, this limit shall be applied to Zone-3 phase fault resistive reach.)	85 degrees 400kV
28	a) What are the Zones blocked on Power swing block function: b) Setting for Unblock timer: (typical 02 second) c) Out of Step trip enabled	ZONE 2, 3, 4  Yes
29	Whether the location of Out of step relay has been identified on the basis of power system simulation studies	Yes
30	a) Is the Disturbance recorder and Fault locator provided on all line feeder? b) Whether standalone or built in Main relay c) Whether DR is having automatic fault record download facility to a central PC d) Whether DR is time synchronized with the GPS based time synchronizing equipment e) Whether DR analog channels contain line phase & neutral current and line phase & neutral voltage. f) Whether DR digital channel as a minimum contain the CB status, Main-I & II trip status, LBB trip status, Over-voltage trip status, Stub protn trip status, Permissive and direct carrier receive status, Line reactor trip status.	Yes  Built in  No  Yes
31	Does the setting document for the numerical relays (IED) contain all the settings for all functions that are used and indicates clearly the functions not used (to be blocked / Disabled)? Are all default settings validated or revised settings are given in the setting document?	Yes

## B. Power Transformers

1	Do you use Group A and Group B protections connected to separate DC sources for power transformers	Yes										
2	Do you follow CBIP guideline (274 & 296) for protection setting of transformer	Yes										
3	Do you use duplicated PRD and Bucholtz initiating contact for power transformers at 765kV and 400kV levels	No										
4	Do you classify transformer protections as below in groups: <table style="width: 100%; border: none;"> <tr> <td style="width: 50%; text-align: center;">Group A</td> <td style="width: 50%; text-align: center;">Group B</td> </tr> <tr> <td>• Biased differential relay</td> <td>Restricted earth fault (REF) relay</td> </tr> <tr> <td>• PRD , WTI</td> <td>Buchholz Protection, OTI</td> </tr> <tr> <td>• Back up Protection(HV)</td> <td>Back up Protection(MV)</td> </tr> <tr> <td>• Over fluxing protection(HV)</td> <td>Over fluxing protection(MV)</td> </tr> </table>	Group A	Group B	• Biased differential relay	Restricted earth fault (REF) relay	• PRD , WTI	Buchholz Protection, OTI	• Back up Protection(HV)	Back up Protection(MV)	• Over fluxing protection(HV)	Over fluxing protection(MV)	Yes
Group A	Group B											
• Biased differential relay	Restricted earth fault (REF) relay											
• PRD , WTI	Buchholz Protection, OTI											
• Back up Protection(HV)	Back up Protection(MV)											
• Over fluxing protection(HV)	Over fluxing protection(MV)											
5	In case of Breaker & half switching scheme, whether CT associated with Main & Tie Breakers are connected to separate bias winding of the low impedance Biased differential protection in order to avoid false operation due to dissimilar CT response.	Yes										
6	Is Restricted earth fault (REF) protection used a high impedance type	Yes										
7	Are Main protection relays provided for transformer are of numerical design?	Yes										
8	a) Are directional over current & earth fault relays provided as back-up protection of Transformer are of numerical design. b) Do the back-up earth fault relays have harmonic restrain feature	Yes										
9	Is Fire protection system (HVW type) provided for power transformer and functioning	Yes										
10	a) Is the Disturbance recorder provided for Transformer feeder b) Whether standalone or built in Main relay c) Whether DR is having automatic fault record download facility to a central PC d) Whether DR is time synchronised with the GPS time synchronising equipment	Yes Built in No Yes										
11	Does the setting document for the numerical relays (IED) contain all the settings for all functions that are used and indicates clearly the functions not used (to be blocked / Disabled)? Are all default settings validated or revised settings are given in the setting document?	Yes										

### C. Shunt Reactors

1	Do you use Group A and Group B protections connected to separate DC sources for reactors	Yes				
2	Do you follow CBIP guideline (274 and 296) for protection setting of reactors	Yes				
3	Do you use duplicated PRD and Bucholtz initiating contact for Reactors at 765kV and 400kV levels	No				
4	Do you classify Reactor protections as below in groups:  <table style="width: 100%; border: none;"> <tr> <td style="text-align: center; width: 50%;">Group A</td> <td style="text-align: center; width: 50%;">Group B</td> </tr> <tr> <td> <ul style="list-style-type: none"> <li>• Biased differential relay</li> <li>• PRD , WTI</li> <li>• Back up impedance Protection Or Direction O/C &amp; E/F relay</li> </ul> </td> <td> <ul style="list-style-type: none"> <li>R.E.F Protection</li> <li>Buchholz Protection, OTI</li> </ul> </td> </tr> </table>	Group A	Group B	<ul style="list-style-type: none"> <li>• Biased differential relay</li> <li>• PRD , WTI</li> <li>• Back up impedance Protection Or Direction O/C &amp; E/F relay</li> </ul>	<ul style="list-style-type: none"> <li>R.E.F Protection</li> <li>Buchholz Protection, OTI</li> </ul>	Yes
Group A	Group B					
<ul style="list-style-type: none"> <li>• Biased differential relay</li> <li>• PRD , WTI</li> <li>• Back up impedance Protection Or Direction O/C &amp; E/F relay</li> </ul>	<ul style="list-style-type: none"> <li>R.E.F Protection</li> <li>Buchholz Protection, OTI</li> </ul>					
5	In case of Breaker & half switching scheme, whether CT associated with Main & Tie Breakers are connected to separate bias winding of the low impedance Biased differential protection in order to avoid false operation due to dissimilar CT response.	Yes				
6	Is Restricted earth fault (REF) protection used a high impedance type	Yes				
7	Are Main & back-up protection relays provided for Reactor are of numerical design.	Yes				
8	Is Fire protection system (HVW type) provided for Reactor and functioning	Yes				
9	a) Is the Disturbance recorder and Fault locator provided on all the Shunt Reactors used in 765 kV, 400 kV substations?  b) Whether standalone or built in Main relay  c) Whether DR is having automatic fault record download facility to a central PC	Yes  BUILT IN  No				
10	Does the setting document for the numerical relays (IED) contain all the settings for all functions that are used and indicates clearly the functions not used (to be blocked / Disabled)? Are all default settings validated or revised settings are given in the setting document?	Yes				



#### D. Bus Bars

1	Bus Bar protection for 765, 400 & 220kV buses is provided	Yes
2	Duplicated Bus bar protection is provided for 765kV and 400kV buses	Yes
3	CBIP guideline for Protection (274 and 296) settings is followed	Yes
4	In an existing substation if CTs are of different ratios, is biased type bus protection provided.	N.A
5	In stations where single bus bar protection is provided, is backup provided by reverse looking elements of distance relays or by second zone elements of remote end distance relays?	N.A
6	In case of GIS where burn through time of SF6 is shorter than remote back up protection is the bus bar protection duplicated irrespective of voltage level?	N.A
7	Since it is difficult to get shutdowns to allow periodic testing of bus protection, numerical bus protections with self-supervision feature is an answer. Is this followed?	Yes
8	Does the setting document for the numerical relays (IED) contain all the settings for all functions that are used and indicates clearly the functions not used (to be blocked / Disabled)? Are all default settings validated or revised settings are given in the setting document?	Yes

#### E. Disturbance Recorder (DR) and Event Logger (EL)

1	<p>a) Is the Disturbance recorder and Fault locator provided on all line feeder of 765, 400 &amp; 220kV substations?</p> <p>b) Whether standalone or built in Main relay</p> <p>c) Whether DR is having automatic fault record download facility to a central PC</p> <p>d) Whether Central PC for DR , EL are powered by Inverter (fed from station DC)</p>	<p>Yes</p> <p>Built In</p> <p>No</p> <p>Yes</p>
---	---	---

2	<p>Whether DR is having the following main signals for lines:</p> <p><u>Analogue signals:</u></p> <ul style="list-style-type: none"> <li>• From CT: IA, IB, IC, IN</li> <li>• From VT: VAN, VBN, VCN</li> <li>• From Aux. VT: V0</li> </ul> <p><u>Digital Signals</u></p> <ul style="list-style-type: none"> <li>• Main 1 Carrier receive</li> <li>• Main 1 Trip</li> <li>• Line O/V Stage I / Stage II</li> <li>• Reactor Fault Trip</li> <li>• Stub Protection Operated.</li> <li>• Main II Trip</li> <li>• Main II Carrier Receive</li> <li>• Direct Trip CH I / II</li> <li>• CB I Status (PH-R, Y &amp; B)</li> <li>• CB II Status (PH R, Y &amp; B)</li> <li>• Busbar trip</li> <li>• Main / Tie CB LBB Operated</li> <li>• Main / Tie Auto-reclose operated.</li> </ul> <p>DR for Transformer / Reactor feeder should contain analog channel like input currents &amp; voltage. Binary signal include all protection trip input, Main &amp; Tie CB status, LBB trip</p>	
3	Whether substation (765, 400 , 220kV) is having Event logger facility (standalone or built-in-SAS)	Yes (Built In Relay)
4	Whether GPS based time synchronizing equipment is provided at the substation for time synchronizing of Main relays / DR/ Event logger / SAS/ PMU / Line Current Differential Relays	Yes

#### F. Circuit Breakers

1	Is breaker fail protection ( LBB / BFR) provided for all the Circuit Breakers at 220kV , 400kV & 765kV rating	Yes
2	For Circuit Breaker connected to line feeder / transformer feeder, whether operation of LBB / BFR sends direct trip signal to trip remote end breaker ?	Yes

3	For lines employing single phase auto reclosing, Is start signal from protection trip to LBB / BFR relay is given on single phase basis?	Yes
4	Is separate relay provided for each breaker and the relay has to be connected from the secondary circuit of the CTs associated with that particular breaker?	Yes
5	Is LBB relay provided with separate DC circuit independent from Group-A and Group-B Protections?	No
6	Is the LBB initiation provided with initiating contact independent of CB trip relay contact?	Yes
7	Is Separation maintained between protective relay and CB trip coil DC circuit so that short circuit or blown fuse in the CB circuit will not prevent the protective relay from energizing the LBB scheme?	Yes
8	Is LBB relay initiated by Bus bar protection in addition to other fault sensing relays, since failure of CB to clear a bus fault would result in the loss of entire station if BFP relay is not initiated?	Yes
9	Is tripping logic of the bus bar protection scheme used for LBB protection also?	Yes
10	Are the special considerations provided to ensure proper scheme operation by using Circuit Breaker contact logic in addition to current detectors in cases breaker-fail relaying for low energy faults like buchholz operation?	Yes
11	Are the Current level detectors set as sensitive as the main protection? (Generally setting of 0.2 A is commonly practiced for lines and transformers)	Yes
12	Is timer set considering breaker interrupting time, current detector reset time and a margin? (Generally a timer setting of 200ms has been found to be adequate)	Yes
13	Is the back-up fault clearance time is shorter than the operating time of the remote protections (distance relay Zone-2)?	Yes
14	Is the breaker failure protection provided with two steps ( First stage – retrip own CB, Second stage- Trip all associated CBs). This mitigates unwanted operation of breaker failure protection during maintenance and fault tracing.	Yes
15	Is the breaker failure protection hardware provided is separate from line /transformer feeder protection?	Yes

### G. Communication Systems:

1	a) Do you use PLCC for tele-protection of distance relays at 765, 400 & 220kV feeders	PLCC & OPGW Both
	b) Specify type of coupling	Ph-Ph
	c) Whether redundant PLCC channels provided for 400 & 765kV lines	Yes
	d) Specify number of PLCC channels per circuit :	Two
	e) Whether dependability & security of each tele-protection channel measured & record kept ?	No

2	<p>a) In case you use OPGW for tele-protection, are they on geographically diversified route for Main-I and Main-II relay?</p> <p>b) Whether dedicated fibre is being used for Main-I / Main-II relay or multiplexed channel are being used.</p>	Yes
---	--	-----

#### H. Station DC Supply Systems:

1	Do you have two separate independent DC system (220V or 110V) (Source-A and Source-B)	Yes 220 V
2	Do you have two independent DC system (48V) for PLCC (source-A and source-B)	Yes
3	There is no mixing of supplies from DC source-A and DC source-B	Yes
4	Whether the protection relays and trip circuits are segregated into two independent system fed through fuses from two different DC source	Yes
5	<p>Whether Bay wise distribution of DC supply done in the following way:</p> <p>a) Protection</p> <p>b) CB functions</p> <p>c) Isolator / earth switch functions</p> <p>d) Annunciation / Indications</p> <p>e) Monitoring functions</p>	Yes
6	<p>Whether following has been ensured in the cabling:</p> <p>a) Separate cables are used for AC &amp; DC circuits</p> <p>b) Separate cables are used for DC-I &amp; DC-II circuits</p> <p>c) Separate cables are used for different cores of CT and CVT outputs to enhance reliability &amp; security</p>	Yes
7	Is guidelines prescribed in CBIP manual 274 & 296 followed in general	Yes

#### I. Performance Indices:

1	Is there a system of periodically measuring Dependability & Security of Protection system (as given in CBIP manual 296) and recorded	No
2	Is there a system of periodically measuring Dependability of switchgear associated with Protection system and recorded	No
3	Is there a process of Root cause analysis of unwanted tripping events	No
4	Are improvement action like revision of relay setting, better maintenance practices, modernising & retrofitting of switching & protection system taken based on above data.	Record on log book Maintained & implement based on same

		implemented
5	Is attention also given to DC supply system, tele-protection signalling, healthiness of tripping cables, terminations etc. in order to improve the performance of fault clearance system	No

G Line Parameters											
Sr. No.	Name of line	Type of Conductor	Line parameters (In ohms /per km/per phase /primary value)							Relay Settings Enclose setting file	
			Line Length (km)	R1	X1	R0	X0	R0M	X0M	Adopted	Recommended
1	400 KV STPS NEW-BIKANER-1 Line	Twin Moose	142	0.0288	0.30768	0.16192	1.24	0	0	*Settings are as shown in rep	
2	400 KV STPS NEW-BIKANER-2 Line	Twin Moose	142	0.0288	0.30768	0.16192	1.24	0	0		

# 7

# SHORT CIRCUIT STUDY & ANALYSIS

# SHORT CIRCUIT STUDY AND ANALYSIS:

## 7.1 Introduction

This section of report describes the Objectives and Outcomes of Short circuit study and also discusses the methodology adopted by ERDA for Short circuit study and analysis. This includes as under:

- Objective of Short circuit study
- Outcomes of Short circuit study
- Glossary for Short circuit study
- Methodology for Short circuit study

## 7.2 Objective of Short circuit study

The basic aim of the short circuit study is to verify the duty of electrical devices under fault condition and also to establish the fault levels of system at various voltage levels for various operating philosophy of plant. Fault duties are in compliance with the latest editions of the IEC- 60909.

The ETAP Short-Circuit Analysis program analyzes the effect of 3-phase, line-to-ground, line-to- line, and line-to-line-to-ground faults on electrical distribution systems. The program calculates the total short circuit currents as well as the contributions of individual motors, generators, and utility ties in the system.

## 7.3 Glossary for Short circuit study

- **3-Phase Faults - Device Duty (IEC 60909)**

This study calculates initial symmetrical RMS, peak, symmetrical and asymmetrical breaking RMS, and steady-state RMS short circuit currents and their DC offset at faulted buses. ETAP checks the protective device for rated making and breaking capacities against the fault currents and flags inadequacy in devices if any. Generators and motors are modeled by their positive sequence sub-transient reactance.

- **LG, LL, LLG, & 3-Phase Faults (IEC 60909) (Relay Co-ordination Duty)**

This study performs line-to-ground, line-to-line, line-to-line-to-ground, and 3-phase fault studies as per IEC 60909 Standard. This study calculates initial symmetrical RMS, peak and symmetrical breaking RMS, and steady-state RMS short circuit currents at faulted buses. Generators are modeled by their positive, negative, and zero sequence reactance, and motors are modeled by their locked-rotor impedance. It is assumed that the negative sequence impedance of a machine is equal to its positive

sequence impedance. Generator, motor, and transformer grounding types, and winding connections are taken into consideration when constructing system positive, negative, and zero sequence networks.

- **Synchronous Machine Direct-Axis Sub-transient Reactance ( $X_d''$ ) Adjustment**

The direct-axis sub-transient reactance ( $X_d''$ ) for a synchronous generator will always be adjusted by the  $X_d''$  tolerance value entered in the Impedance/Model page of the machine editor. The Short-Circuit module reduces the  $X_d''$  value by the specified percent tolerance resulting in smaller impedance and consequently a higher fault current. For example, if the  $X_d''$  value is 10% and its tolerance is 5%, then the adjusted  $X_d''$  value used in the short circuit calculation is 9.5%.

- **Initial Symmetrical Short circuit current ( $I''_k$ )**

This is the RMS value of the AC symmetrical component of an available short circuit current applicable at the instant of Short circuit if the impedance remains at zero time value.

- **Peak Short Circuit Current ( $i_p$ )**

This is the maximum possible instantaneous value of the available Short circuit current.

- **Symmetrical Short Circuit Breaking Current ( $I_b$ )**

This is the RMS value of an integral cycle of the symmetrical AC component of the available Short circuit current at the instant of contact separation of the first pole of a switching device.

- **Steady-State Short Circuit Current ( $I_k$ )**

This is the RMS value of the short circuit current, which remains after the decay of the transient phenomena.

- **Sub-transient Reactance ( $X_d''$ ) of a Synchronous Machine**

This is the effective reactance at the moment of short circuit. For the calculation of Short circuit currents, the saturated value of ( $X_d''$ ) is taken.

- **Minimum Time Delay ( $T_{min}$ ) of a Circuit Breaker**

This is the shortest time between the beginning of the short circuit current and the first contact separation of one pole of the switching device. The time delay ( $T_{min}$ ) is the sum of the shortest possible operating time of an instantaneous relay and the shortest opening time of a circuit breaker.



Minimum time delay does not include the adjustable time delays of tripping devices.

- **Comparison of Device Rating and Short-Circuit Duty**

In the 3-phase Device Duty calculation, ETAP compares the protective device rating against bus Short circuit current duty for the devices that are checked as complying with IEC Standard and also have device rating entered.

In case the Short circuit duty is greater than the device duty, ETAP will flag the device as underrated in both one-line diagram and output reports.

## 7.4 METHODOLOGY FOR SHORT CIRCUIT STUDY:

### 7.4.1 ETAP Model

ETAP provides three options to specify pre-fault voltage in terms of “c” factor as under:

- Maximum
- User-Defined c Factor
- Minimum

When the Max option is selected, values for c factor as defined in IEC 60909 Standard are used to calculate maximum fault current which are as under:

< 1001 V c Factor = 1.10

1001 to 35000 V c Factor = 1.10

> 35000 V c Factor = 1.10

When the User-Defined c Factor option is selected, ETAP uses the user specified c factor. The ranges for the c factors are as follows:

< 1001 V c Factor = 0.95 -- 1.10

1001 to 35000 V c Factor = 1.00 -- 1.10

> 35000 V c Factor = 1.00 -- 1.10

When the Min. option is selected, values for c Factor, as defined in IEC 60909 Standard, are used to calculate minimum fault current which are as under:

< 1001 V c Factor = 0.95

1001 to 35000 V c Factor = 1.00

> 35000 V c Factor = 1.0

**For evaluating device duty of equipments c factor has been selected as maximum and for relay-coordination duty c factor has been selected as minimum**

### **CALCULATION OF SHORT CIRCUIT CURRENT CLOSE TO TRANSFORMER:**

If the MCCB is used as a main switch, whether for a transfer or for a distribution breaker close to the transformer, a rough estimate of the short-circuit current can be made. The percentage impedance of the transformer Z can be obtained from the nameplate. The short circuit current can be calculated with the help of the following simple formula:

$$I_{SC} = I_n \times 100/Z$$

Where,

$I_{SC}$  = short-circuit current (A)

$I_n$  = rated current of the transformer (Full load current)

Z = percentage impedance of the transformer

The rated current of the transformer( $\Delta/Y$ ) is calculated as follows:

$$I_n = S \times 1000 / (\sqrt{3} \times U_e)$$

S = rating of transformer in kVA

$U_e$  = rated voltage at the low voltage side

For example,

A transformer with S = 1000kVA, Z = 5% and  $U_e = 415$  V

$$I_n = 1000 \text{ kVA} \times 1000 / (\sqrt{3} \times 415 \text{ V}) = 1393 \text{ A}$$

$$I_{SC} = 1393 \text{ A} \times 100/5 = 27760 \text{ Amps}$$

In this example, the short-circuit current for a fault close to the transformer is approximately 27 kA. The breaking capacity of the MCCB to be installed at this point should be higher than this value. This is applicable if a high breaking capacity MCCB with an ultimate short circuit breaking capacity  $I_{sc} = 35$  kA or 50 kA is used here.

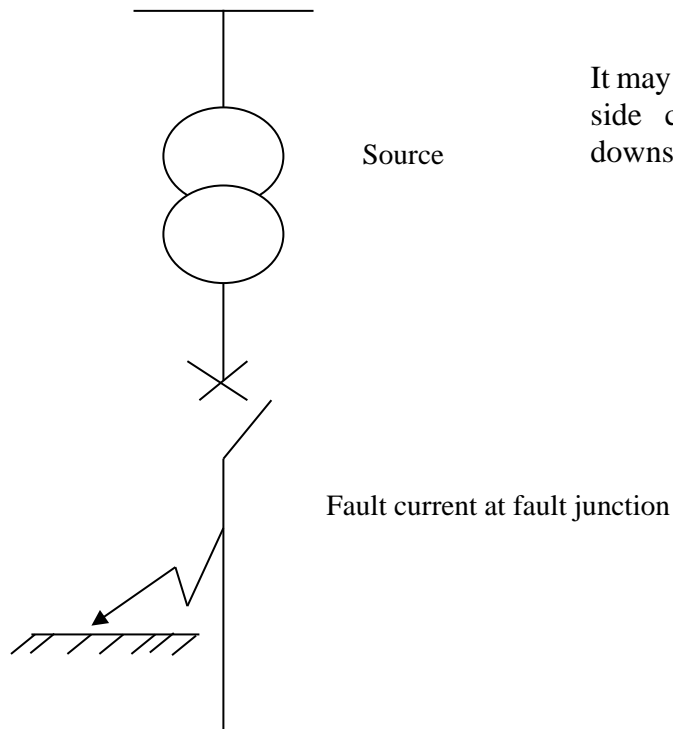

It may be noted that a 100 kA fault at upstream side can be reduced to 5 kA levels at downstream.

In a supply system, if we move away from the source the impedance will be higher, resulting in lower the value for the short-circuit current. Each length of conductor or device in the circuit provides an impedance which reduces the short-circuit current. To calculate the maximum level of the short-circuit current, all the impedances between the transformer and the MCCB must be considered.

#### 7.4.2 System parameters

Negative tolerance of Generator and Transformer parameters has been used for Short circuit study calculations.

- The voltage and frequency limits against which the study results are compared for satisfactory operation are taken as under:
- Switchgear is considered to be adequately rated for system faults if the maximum calculated fault level is less than 90% of the equipment rating. The 10% margin takes into account contribution from both sources & loads.

### 7.4.3 Short Circuit Study Configurations

ERDA has conducted Short circuit study under two separate headings viz. Device Duty and Relay Co-ordination. Whereas device duty report checks for the adequacy of ratings of switchgears, in relay co-ordination study ETAP gives minimum values of short circuit currents so that relay settings can be established.

- As suggested, Fault level of Grid is taken as per below:

Name of the Line	3-Phase (MVAsc)	1-Phase (MVAsc)
400kV Bikaner (1 & 2)	19494	12042

ETAP results of Short circuit study confirm the adequacy of system parameters and Equipment ratings for the reliable operation of the system.

## **7.5 Short Circuit Study Results:**

This study has been conducted by using the suitable Power System simulation software. In this study, we can see the various faults e. g. a) 3 phase fault, b) Double Line to Ground fault, c) Double Line fault, d) Line to Ground fault have been imposed on the buses to check whether the breaker capacity is adequate to trip the bus or not.

In this study, each and every bus as formulated during the short circuit study has been covered. In case of higher current observed than the rating of the circuit breaker, the system show the overload and Protection Engineer required to increase the capacity of breaker post analysis of system.

## **7.6 ETAP crystal reports**

Results observed from Short circuit study of the system have been summarized are as shown here under:

# ETAP REPORT ALL FAULTS SUMMARY TABLE

### **FAULT LEVEL SUMMARY TABLE**

ID	3Phase Fault (KA)	LG FAULT (kA)	LL FAULT (kA)	LLG FAULT (kA)
7CAT01 HT Bus	16.940	0.420	23.377	23.478
7CAT02 HT Bus	16.940	0.419	22.604	22.704
7DAT01 HT Bus	16.940	0.419	23.258	23.359
7DAT02 HT Bus	16.940	0.419	22.546	22.647
7DBT01 HT Bus	16.940	0.419	23.258	23.359
7DBT02 HT Bus	16.940	0.419	22.546	22.647
7DCT01 HT Bus	16.940	0.419	23.237	23.338
7DCT02 HT Bus	16.940	0.419	22.535	22.636
7DDT01 HT Bus	16.940	0.419	23.247	23.348
7DDT02 HT Bus	16.940	0.419	22.535	22.636
7DET01 HT Bus	16.940	0.419	23.247	23.348
7DET02 HT Bus	16.940	0.419	22.535	22.636
7DFT01 HT Bus	16.940	0.419	23.247	23.348
7DFT02 HT Bus	16.940	0.419	22.535	22.636
8CAT01 HT Bus	16.940	0.420	23.375	23.475
8CAT02 HT Bus	16.940	0.419	21.783	21.884
8DAT01 HT Bus	16.940	0.419	23.256	23.357
8DAT02 HT Bus	16.940	0.419	21.727	21.828
8DBT01 HT Bus	16.940	0.419	23.256	23.357
8DBT02 HT Bus	16.940	0.419	21.727	21.828
8DCT01 HT Bus	16.940	0.419	23.235	23.336
8DCT02 HT Bus	16.940	0.419	21.717	21.818
8DDT01 HT Bus	16.940	0.419	23.245	23.346
8DDT02 HT Bus	16.940	0.419	21.717	21.818
8DET01 HT Bus	16.940	0.419	23.245	23.346
8DET02 HT Bus	16.940	0.419	21.717	21.818
8DFT01 HT Bus	16.940	0.419	23.245	23.346
8DFT02 HT Bus	16.940	0.419	21.717	21.818
Bikaner S/s	28.311	17.705	24.661	25.576
BKL1R Bus	29.565	31.197	26.047	30.875
BKL2R Bus	29.565	31.196	26.046	30.874
Bus-1 CVT Bus	29.565	31.197	26.047	30.875
Bus-2 CVT Bus	29.565	31.196	26.046	30.874
Colony Load1 Bus	25.643	0.420	27.532	27.636
Colony Load2 Bus	25.643	0.420	26.603	26.707
CW-7A Bus	15.493	0.416	20.261	20.358
CW-7B Bus	15.511	0.416	20.298	20.395
CW-7C Bus	15.548	0.416	19.836	19.933
CW-7D Bus	15.586	0.416	19.906	20.003



ID	3Phase Fault (KA)	LG FAULT (kA)	LL FAULT (kA)	LLG FAULT (kA)
CW-8A Bus	15.341	0.416	19.959	20.056
CW-8B Bus	15.341	0.416	19.959	20.056
CW-8C Bus	15.323	0.416	18.828	18.925
FD-7A Bus	16.242	0.418	21.792	21.891
FD-7B Bus	15.736	0.417	20.190	20.288
FD-8A Bus	16.158	0.418	21.613	21.712
FD-8B Bus	15.717	0.417	19.517	19.615
GT-7 HT Bus	29.565	31.197	26.047	30.875
GT-8 Bus	29.565	31.196	26.046	30.874
IDF-7A Bus	15.868	0.417	21.126	21.224
IDF-7B Bus	15.586	0.416	20.030	20.127
IDF-8A Bus	15.815	0.417	21.020	21.118
IDF-8B Bus	15.548	0.416	19.343	19.441
MAIN BUS-I	29.565	31.197	26.047	30.875
MAIN BUS-II	29.565	31.196	26.046	30.874
MDBFP-7A Bus	26.351	0.420	28.518	28.622
MDBFP-8A Bus	25.447	0.420	29.471	29.575
OCAT01 HT Bus	25.643	0.420	29.303	29.408
OCAT02 HT Bus	25.643	0.420	30.239	30.343
OCBT01 HT Bus	25.643	0.420	27.578	27.682
OCBT02 HT Bus	25.643	0.420	26.647	26.752
OCCT01 HT Bus	25.643	0.420	27.554	27.658
OCCT02 HT Bus	25.643	0.420	26.624	26.728
OCDT01 HT Bus	25.643	0.420	27.697	27.801
OCDT02 HT Bus	25.643	0.420	26.762	26.866
ODAT01 HT Bus	25.643	0.420	27.563	27.667
ODAT02 HT Bus	25.643	0.420	26.633	26.737
ODBT01 HT Bus	25.643	0.420	27.563	27.667
ODBT02 HT Bus	25.643	0.420	26.633	26.737
ODCT01 HT Bus	25.643	0.420	27.550	27.654
ODCT02 HT Bus	25.643	0.420	26.620	26.724
ODDT01 HT Bus	25.643	0.420	27.534	27.638
ODDT02 HT Bus	25.643	0.420	26.604	26.709
ODET01 HT Bus	25.643	0.420	28.751	28.856
ODET02 HT Bus	25.643	0.420	29.669	29.773
PAF-7A Bus	15.944	0.417	21.205	21.304
PAF-7B Bus	15.773	0.417	20.297	20.395
PAF-8A Bus	16.054	0.417	21.429	21.528
PAF-8B Bus	16.112	0.418	20.250	20.349
SS-7C	26.465	0.421	29.963	30.068
SS-7D	26.465	0.421	28.662	28.767
SS-8C	26.465	0.421	30.967	31.071

ID	3Phase Fault (KA)	LG FAULT (kA)	LL FAULT (kA)	LLG FAULT (kA)
SS-8D	26.465	0.421	27.652	27.757
STPS	30.517	33.804	26.886	32.692
US-7A	17.290	0.420	24.045	24.147
US-7B	17.290	0.420	23.285	23.386
US-8A	17.290	0.420	24.043	24.144
US-8B	17.290	0.420	22.408	22.510

# 8

## Relay Co-ordination Studies:

### 8.1 Protective Relaying Philosophy

In spite of all the precautions taken in the design and installation of such system (catering to various loads containing major components like Transformers, Cables etc.), there are bound to arise abnormal conditions or faults. For example short circuits may prove extremely damaging not only to the faulty components but to the neighboring components and to the power system as whole. It is of vital importance to limit the damage to a minimum by speedy isolation of the faulty section, without disturbing the healthy system.

#### 8.1.1 REQUIREMENT OF PROTECTION SYSTEM:

Following important quality requirements are to be fulfilled by a good protective system:

**1) RELIABILITY:** Reliability is a qualitative term. Quantitatively it can be expressed as probability of failure. Failure is not confined to protective relay only but may also be due to breaker defects or unfaithful transformation of transducers or open circuit in control wiring. Therefore every component involved in protection must be regarded as a potential source of failure. Regular and thorough maintenance of protective equipment, quality of personnel operating the system and inherent design features and fabrication make the protective system reliable.

Reliability is the measure of the degree of certainty that the relay or relay system will perform correctly. Reliability denotes certainty of correct operation (dependability) together with assurance against incorrect operation from all extraneous cause (security).

**2) SELECTIVITY:** This is the property by which only the faulty element of the system is be isolated and the remaining healthy sections are left intact. Selectivity is absolute if the protection responds only to faults within its own zone and relative if it is obtained by grading the settings of the protection of several zones all of which may respond to a given fault. System of protection which, in principle, are absolutely selective are known as unit system. Systems in which selectivity is relative are known as non-unit systems. Differential protection is a unit protective system and current – time graded protection or distance protection are non-unit systems.

**3) SPEED:** It is obvious that faster the speed of operation of elements of protective system (relay & breaker), less is the damage to the equipment. As such, equipment are short time rated for high current and therefore there will be practically no damage to the equipment if the relays and breaker operate fast. The time setting of the relay has to be decided on the basis of this short time rating of the equipment to be protected.

**4) DISCRIMINATION:** Protective system should be able to discriminate between faults and load conditions even when the minimum fault current is less than the maximum load current. A relay should be able to distinguish between a fault and an overload. In the case of transformers; the inrush of magnetizing current may be comparable to the fault current. The relay should not operate for such inrush currents. In interconnected systems, there will be power swings, which should also be ignored by the distance relay protecting transmission lines.

**5) SENSITIVITY:** Sensitivity refers to the minimum level of fault current at which operation occurs. In other words, it is the fault setting and is usually expressed in operating quantity referred to the primary of transducer.

## **8.2 OVER CURRENT CO-ORDINATION**

The co-ordination of protection system is very important to ensure that a fault is cleared with minimum disturbance to the system by isolating faulty portion quickly and safe guarding the integrity of the remaining system. This requires proper selectivity of the various relays located at different places in the system. In case of over current relaying system co-ordination; the operating times is provided through inverse time characteristics or definite time characteristics. The relay close to the fault has the lowest operating time and the one farthest from the fault has the largest operating time.

Reliability of power system operation mainly depends on the integrated performance of relays. The relays should operate for all faults in its own zone and also provide backup protection for faults in immediately adjoining system elements in the downstream, ensuring a minimum dislocation following a breakdown. The important features that protection scheme should possess reliability and selectivity. Protective system shall be ensured for reliability and selectivity.

In short (summary); the co-ordination study is carried out for:

- (1) To determine characteristics, ratings & settings of overcurrent protective devices.
- (2) To ensure that the minimum unfaulty load is interrupted when the protective device isolates a fault or overload anywhere in the system.
- (3) The device and its settings selected should provide satisfactory protection against overloads on the equipment and interrupt short circuits as rapidly as possible.
- (4) Minimize the equipment damage and process outage costs,
- (5) To protect personnel from the effects of these failures

Protective relays plays an important role in the operation of power network. If they are correctly applied; they provide protection for both equipment & personnel together & ensure the best possible quality of electric power supply.

The detection & elimination of different faults require several types of protective relays.

Over current relays can be set in two manners. (1) Discrimination by time & (2) Discrimination by time & current. First category can be termed instantaneous overcurrent relay where relay operates on pre decided current & trip given by time. In second category; the timing of the tripping depends on how much higher the current is sensed by relay and timing will be taken accordingly. This is called Inverse over current relay.

#### **PHASE INSTANTANEOUS OVERCURRENT (50P)**

A high set instantaneous overcurrent intended to operate for close faults with high short circuit current. The setting applied is usually higher than the maximum short circuit current beyond the closest downstream device (breaker or fuse) and above the feeder inrush current.

#### **PHASE INVERSE TIME OVERCURRENT (51P)**

The settings of these elements must be coordinated with the downstream and upstream devices which should be above the feeder maximum load current and less than short circuit current.

#### **TRANSFORMER PROTECTION:**

The transformer is one of the most important links in a power system. Because of its relatively simple construction, it is a highly reliable piece of equipment. Protection of such key elements in power system is very important. Being static, totally enclosed, it develops faults rarely but the consequences of even a rare fault may be serious unless the transformer is quickly disconnected from the system.

#### **OVERLOAD PROTECTION FOR PHASE FAULTS [50, 51]**

On the primary side of transformers, an overcurrent relay having a time-delayed low-set unit and an instantaneous high-set unit can be used. The low-set level is set to be selective ('graded') with the downstream protection, in order to provide back up and to eliminate internal faults of relatively low amplitude.

The use of an inverse-time relay is sometimes preferable under the following circumstances:

- The outgoing feeders on the transformer secondary side are protected by either ACB or another inverse time relay.
- The system operation gives the possibility of relatively high overloads of several seconds duration (for example motor re-accelerations).
- The magnetizing currents during transformer energization are of high amplitude and decrease slowly.

The high-set instantaneous unit is set slightly above the symmetrical three-phase short-circuit current on the secondary side (approximately + 20%) and also above the transformer inrush current. Set in this manner it remains insensitive to faults on the low-voltage side, ensuring that there is no possibility of a spurious instantaneous trip for a downstream fault.

However, this unit will operate very rapidly in the event of a heavy fault within the transformer, or a fault affecting the primary side feeder. Therefore use of a relay with a high-set instantaneous unit for transformer protection enables a considerable reduction in the operating times of upstream protection for heavy fault levels which are the most damaging. Due to this, it is also possible to reduce short-circuit withstand requirements for the transformer supply cables.

# **8.3**

# **Existing &**

# **Recommended**

# **Protection Settings**

### Existing relay settings

Relay ID	CT Ratio	Trip Element	Level	Curve	Tap (Pickup)		Time Dial / Mult.	Instantaneous		Inst. Delay
					Setting	Primary	Setting	Settings	Primary	Setting
US-7A IC Relay	2500:1	Phase	OC1	IEC - Standard Inverse	1.000	2500.000	0.275			
US-7A IC Relay	2500:1	Neutral	OC1					0.080	200.00	0.5 s
7DAT01 Relay	150:1	Phase	OC1	IEC - Normal Inverse	1.000	150.000	0.320	11.400	1710.00	0.04 s
7DAT01 Relay	50:1	Ground	OC1					0.200	10.00	0.2 s
7DBT01 Relay	150:1	Phase	OC1	IEC - Normal Inverse	1.000	150.000	0.400	11.400	1710.00	0.04 s
7DBT01 Relay	50:1	Ground	OC1					0.200	10.00	0.2 s
7DCT01 Relay	100:1	Phase	OC1	IEC - Normal Inverse	1.000	100.000	0.350	13.700	1370.00	0.04 s
7DCT01 Relay	50:1	Ground	OC1					0.200	10.00	0.2 s
7DDT01 Relay	100:1	Phase	OC1	IEC - Normal Inverse	1.000	100.000	0.350	13.700	1370.00	0.04 s
7DDT01 Relay	50:1	Ground	OC1					0.200	10.00	0.2 s
7DET01 Relay	100:1	Phase	OC1	IEC - Normal Inverse	1.000	100.000	0.350	13.700	1370.00	0.04 s
7DET01 Relay	50:1	Ground	OC1					0.200	10.00	0.2 s
7DFT01 Relay	100:1	Phase	OC1	IEC - Normal Inverse	1.000	100.000	0.350	13.700	1370.00	0.04 s
7DFT01 Relay	50:1	Ground	OC1					0.200	10.00	0.2 s
PAF-7A Relay	250:1	Phase	OC1	Definite Time	1.500	375.000	28.000	6.500	1625.00	0.04 s
PAF-7A Relay	50:1	Ground	OC1					0.390	19.50	0.1 s
IDF-7A Relay	300:1	Phase	OC1	Definite Time	1.500	450.000	30.400	6.500	1950.00	0.04 s
IDF-7A Relay	50:1	Ground	OC1					0.500	25.00	0.1 s
CW-7A Relay	200:1	Phase	OC1	Definite Time	1.500	300.000	14.400	6.500	1300.00	0.04 s
CW-7A Relay	50:1	Ground	OC1					0.340	17.00	0.1 s
CW-7B Relay	200:1	Phase	OC1	Definite Time	1.500	300.000	14.400	6.500	1300.00	0.04 s
CW-7B Relay	50:1	Ground	OC1					0.340	17.00	0.1 s
FD-7A Relay	200:1	Phase	OC1	Definite Time	1.500	300.000	20.000	6.500	1300.00	0.04 s
FD-7A Relay	50:1	Ground	OC1					0.210	10.50	0.1 s
7CAT01 Relay	1000:1	Phase	OC1	IEC - Normal Inverse	1.000	1000.000	0.150	8.200	8200.00	0.04 s
7CAT01 Relay	50:1	Ground	OC1					0.400	20.00	0.2 s
US-7B IC Relay	2500:1	Phase	OC1	IEC - Standard Inverse	1.000	2500.000	0.275			
US-7B IC Relay	2500:1	Ground	OC1					0.080	200.00	0.5 s
7DAT02 Relay	150:1	Phase	OC1	IEC - Normal Inverse	1.000	150.000	0.320	11.400	1710.00	0.04 s
7DAT02 Relay	50:1	Ground	OC1					0.200	10.00	0.2 s
7DBT02 Relay	150:1	Phase	OC1	IEC - Normal Inverse	1.000	150.000	0.400	11.400	1710.00	0.04 s
7DBT02 Relay	50:1	Ground	OC1					0.200	10.00	0.2 s



Relay ID	CT Ratio	Trip Element	Level	Curve	Tap (Pickup)		Time Dial / Mult.	Instantaneous		Inst. Delay
					Setting	Primary	Setting	Settings	Primary	Setting
7DCT02 Relay	100:1	Phase	OC1	IEC - Normal Inverse	1.000	100.000	0.350	13.700	1370.00	0.04 s
7DCT02 Relay	50:1	Ground	OC1					0.200	10.00	0.2 s
7DDT02 Relay	100:1	Phase	OC1	IEC - Normal Inverse	1.000	100.000	0.350	13.700	1370.00	0.04 s
7DDT02 Relay	50:1	Ground	OC1					0.200	10.00	0.2 s
7DET02 Relay	100:1	Phase	OC1	IEC - Normal Inverse	1.000	100.000	0.350	13.700	1370.00	0.04 s
7DET02 Relay	50:1	Ground	OC1					0.200	10.00	0.2 s
7DFT02 Relay	100:1	Phase	OC1	IEC - Normal Inverse	1.000	100.000	0.350	13.700	1370.00	0.04 s
7DFT02 Relay	50:1	Ground	OC1					0.200	10.00	0.2 s
PAF-7B Relay	250:1	Phase	OC1	Definite Time	1.500	375.000	28.000	6.500	1625.00	0.04 s
PAF-7B Relay	50:1	Ground	OC1					0.390	19.50	0.1 s
IDF-7B Relay	300:1	Phase	OC1	Definite Time	1.500	450.000	30.400	6.500	1950.00	0.04 s
IDF-7B Relay	50:1	Ground	OC1					0.500	25.00	0.1 s
CW-7C Relay	250:1	Phase	OC1	Definite Time	1.500	375.000	14.400	6.500	1625.00	0.04 s
CW-7C Relay	50:1	Ground	OC1					0.340	17.00	0.1 s
CW-7D Relay	250:1	Phase	OC1	Definite Time	1.500	375.000	14.400	6.500	1625.00	0.04 s
CW-7D Relay	50:1	Ground	OC1					0.340	17.00	0.1 s
FD-7B Relay	200:1	Phase	OC1	Definite Time	1.500	300.000	20.000	6.500	1300.00	0.04 s
FD-7B Relay	50:1	Ground	OC1					0.210	10.50	0.1 s
7CAT02 Relay	1000:1	Phase	OC1	IEC - Normal Inverse	1.000	1000.000	0.150	8.200	8200.00	0.04 s
7CAT02 Relay	50:1	Ground	OC1					0.400	20.00	0.2 s
SS-7C IC Relay	3500:1	Phase	OC1	IEC - Standard Inverse	1.000	3500.000	0.400			
SS-7C IC Relay	3500:1	Ground	OC1					0.080	280.00	0.9 s
OCAT01 Relay	2500:1	Phase	OC1	IEC - Normal Inverse	1.000	2500.000	0.330	9.100	22750.00	0.04 s
OCAT01 Relay	50:1	Ground	OC1					0.400	20.00	0.2 s
ODET01 Relay	75:1	Phase	OC1	IEC - Normal Inverse	1.000	75.000	0.210	11.400	855.00	0.04 s
ODET01 Relay	50:1	Ground	OC1					0.200	10.00	0.2 s
SW SRV TRF1 Relay	50:1	Phase	OC1	IEC - Normal Inverse	1.000	50.000	0.270			
SW SRV TRF1 Relay	50:1	Ground	OC1					0.200	10.00	0.2 s
MDBFP-7A Relay1	250:1	Phase	OC1	Definite Time	1.500	375.000	20.800	6.500	1625.00	0.04 s
MDBFP-7A Relay1	50:1	Ground	OC1					2.090	104.50	0.1 s
MDBFP-7A Relay2	250:1	Phase	OC1	Definite Time	1.500	375.000	20.800	6.500	1625.00	0.04 s
MDBFP-7A Relay2	50:1	Ground	OC1					2.090	104.50	0.1 s
OCCT01 Relay	150:1	Phase	OC1	IEC - Normal Inverse	1.000	150.000	0.240	15.200	2280.00	0.04 s
OCCT01 Relay	50:1	Ground	OC1					0.200	10.00	0.2 s

Relay ID	CT Ratio	Trip Element	Level	Curve	Tap (Pickup)		Time Dial / Mult.	Instantaneous		Inst. Delay
					Setting	Primary	Setting	Settings	Primary	Setting
OCDT01 Relay	800:1	Phase	OC1	IEC - Normal Inverse	1.000	800.000	0.300	10.700	8560.00	0.04 s
OCDT01 Relay	50:1	Ground	OC1					0.400	20.00	0.2 s
ODAT01 Relay	150:1	Phase	OC1	IEC - Normal Inverse	1.000	150.000	0.320	11.400	1710.00	0.04 s
ODAT01 Relay	50:1	Ground	OC1					0.200	10.00	0.2 s
Coln Fdr1 Relay	150:1	Phase	OC1	IEC - Extremely Inverse	0.100	15.000	0.050	4.000	600.00	0.04 s
Coln Fdr1 Relay	150:1	Neutral	OC1	IEC - Extremely Inverse	0.010	1.500	0.050	8.000	1200.00	0.1 s
Coln Fdr1 Relay	150:1	Ground	OC1	IEC - Extremely Inverse	0.005	0.750	0.050			
Coln Fdr1 Relay	150:1	Sensitive Ground	OC1	IEC - Extremely Inverse	0.010	1.500	0.050	8.000	1200.00	0.08 s
Coln Fdr1 Relay	150:1	Phase		Thermal Overload	0.500	75.000	2.000			
ODDT01 Relay	50:1	Phase	OC1	IEC - Normal Inverse	1.000	50.000	0.220	14.400	720.00	0.04 s
ODDT01 Relay	50:1	Ground	OC1					0.200	10.00	0.2 s
ODCT01 Relay	100:1	Phase	OC1	IEC - Normal Inverse	1.000	100.000	0.340	13.700	1370.00	0.04 s
ODCT01 Relay	50:1	Ground	OC1					0.200	10.00	0.2 s
ODBT01 Relay	150:1	Phase	OC1	IEC - Normal Inverse	1.000	150.000	0.390	11.400	1710.00	0.04 s
ODBT01 Relay	50:1	Ground	OC1					0.200	10.00	0.2 s
OCBT01 Relay	250:1	Phase	OC1	IEC - Normal Inverse	1.000	250.000	0.320	15.900	3975.00	0.04 s
OCBT01 Relay	50:1	Ground	OC1					0.200	10.00	0.2 s
OCAT02 Relay	2500:1	Phase	OC1	IEC - Normal Inverse	1.000	2500.000	0.330	9.100	22750.00	0.04 s
OCAT02 Relay	50:1	Ground	OC1					0.400	20.00	0.2 s
ODET02 Relay	75:1	Phase	OC1	IEC - Normal Inverse	1.000	75.000	0.210	11.400	855.00	0.04 s
ODET02 Relay	50:1	Ground	OC1					0.200	10.00	0.2 s
SW SRV TRF2 Relay	50:1	Phase	OC1	IEC - Normal Inverse	1.000	50.000	0.270			
SW SRV TRF2 Relay	50:1	Ground	OC1					0.200	10.00	0.2 s
MDBFP-8A Relay1	250:1	Phase	OC1	Definite Time	1.500	375.000	20.800	6.500	1625.00	0.04 s
MDBFP-8A Relay1	50:1	Ground	OC1					2.090	104.50	0.1 s
MDBFP-8A Relay2	250:1	Phase	OC1	Definite Time	1.500	375.000	20.800	6.500	1625.00	0.04 s
MDBFP-8A Relay2	50:1	Ground	OC1					2.090	104.50	0.1 s
ODDT02 Relay	50:1	Phase	OC1	IEC - Normal Inverse	1.000	50.000	0.220	14.400	720.00	0.04 s
ODDT02 Relay	50:1	Ground	OC1					0.200	10.00	0.2 s
OCBT02 Relay	250:1	Phase	OC1	IEC - Normal Inverse	1.000	250.000	0.320	15.900	3975.00	0.04 s

Relay ID	CT Ratio	Trip Element	Level	Curve	Tap (Pickup)		Time Dial / Mult.	Instantaneous		Inst. Delay
					Setting	Primary	Setting	Settings	Primary	Setting
OCBT02 Relay	50:1	Ground	OC1					0.200	10.00	0.2 s
Coln Fdr2 Relay	150:1	Phase	OC1	IEC - Extremely Inverse	0.100	15.000	0.050	4.000	600.00	0.04 s
Coln Fdr2 Relay	150:1	Neutral	OC1	IEC - Extremely Inverse	0.010	1.500	0.050	8.000	1200.00	0.1 s
Coln Fdr2 Relay	150:1	Ground	OC1	IEC - Extremely Inverse	0.005	0.750	0.050			
Coln Fdr2 Relay	150:1	Sensitive Ground	OC1	IEC - Extremely Inverse	0.010	1.500	0.050	8.000	1200.00	0.08 s
Coln Fdr2 Relay	150:1	Phase		Thermal Overload	0.500	75.000	2.000			
ODAT02 Relay	150:1	Phase	OC1	IEC - Normal Inverse	1.000	150.000	0.320	11.400	1710.00	0.04 s
ODAT02 Relay	50:1	Ground	OC1					0.200	10.00	0.2 s
ODCT02 Relay	800:1	Phase	OC1	IEC - Normal Inverse	1.000	800.000	0.340	13.700	10960.00	0.04 s
ODCT02 Relay	50:1	Ground	OC1					0.200	10.00	0.2 s
ODBT02 Relay	150:1	Phase	OC1	IEC - Normal Inverse	1.000	150.000	0.390	11.400	1710.00	0.04 s
ODBT02 Relay	50:1	Ground	OC1					0.200	10.00	0.2 s
OCCT02 Relay	150:1	Phase	OC1	IEC - Normal Inverse	1.000	150.000	0.240	15.200	2280.00	0.04 s
OCCT02 Relay	50:1	Ground	OC1					0.200	10.00	0.2 s
OCDT02 Relay	800:1	Phase	OC1	IEC - Normal Inverse	1.000	800.000	0.300	10.700	8560.00	0.04 s
OCDT02 Relay	50:1	Ground	OC1					0.400	20.00	0.2 s
SS-7D IC Relay	3500:1	Phase	OC1	IEC - Standard Inverse	1.000	3500.000	0.350			
SS-7D IC Relay	3500:1	Ground	OC1					0.080	280.00	0.9 s
SS-8C IC Relay	3500:1	Phase	OC1	IEC - Standard Inverse	1.000	3500.000	0.400			
SS-8C IC Relay	3500:1	Ground	OC1					0.080	280.00	0.9 s
SS-8D IC Relay	2500:1	Phase	OC1	IEC - Standard Inverse	1.000	2500.000	0.350			
SS-8D IC Relay	2500:1	Ground	OC1					0.080	200.00	0.9 s
US-8A IC Relay	2500:1	Phase	OC1	IEC - Standard Inverse	1.000	2500.000	0.275			
US-8A IC Relay	2500:1	Ground	OC1					0.080	200.00	0.5 s
8DAT01 Relay	150:1	Phase	OC1	IEC - Normal Inverse	1.000	150.000	0.320	11.400	1710.00	0.04 s
8DAT01 Relay	50:1	Ground	OC1					0.200	10.00	0.2 s
8DBT01 Relay	150:1	Phase	OC1	IEC - Normal Inverse	1.000	150.000	0.400	11.400	1710.00	0.04 s
8DBT01 Relay	50:1	Ground	OC1					0.200	10.00	0.2 s
8DCT01 Relay	100:1	Phase	OC1	IEC - Normal Inverse	1.000	100.000	0.350	13.700	1370.00	0.04 s
8DCT01 Relay	50:1	Ground	OC1					0.200	10.00	0.2 s

Relay ID	CT Ratio	Trip Element	Level	Curve	Tap (Pickup)		Time Dial / Mult.	Instantaneous		Inst. Delay
					Setting	Primary	Setting	Settings	Primary	Setting
8DDT01 Relay	100:1	Phase	OC1	IEC - Normal Inverse	1.000	100.000	0.350	13.700	1370.00	0.04 s
8DDT01 Relay	50:1	Ground	OC1					0.200	10.00	0.2 s
8DET01 Relay	100:1	Phase	OC1	IEC - Normal Inverse	1.000	100.000	0.350	13.700	1370.00	0.04 s
8DET01 Relay	50:1	Ground	OC1					0.200	10.00	0.2 s
8DFT01 Relay	100:1	Phase	OC1	IEC - Normal Inverse	1.000	100.000	0.350	13.700	1370.00	0.04 s
8DFT01 Relay	50:1	Ground	OC1					0.200	10.00	0.2 s
PAF-8A Relay	250:1	Phase	OC1	Definite Time	1.500	375.000	28.000	6.500	1625.00	0.04 s
PAF-8A Relay	50:1	Ground	OC1					0.390	19.50	0.1 s
IDF-8A Relay	300:1	Phase	OC1	Definite Time	1.500	450.000	30.400	6.500	1950.00	0.04 s
IDF-8A Relay	50:1	Ground	OC1					0.500	25.00	0.1 s
CW-8A Relay	250:1	Phase	OC1	Definite Time	1.500	375.000	14.400	6.500	1625.00	0.04 s
CW-8A Relay	50:1	Ground	OC1					0.340	17.00	0.1 s
CW-8B Relay	250:1	Phase	OC1	Definite Time	1.500	375.000	14.400	6.500	1625.00	0.04 s
CW-8B Relay	50:1	Ground	OC1					0.340	17.00	0.1 s
FD-8A Relay	200:1	Phase	OC1	Definite Time	1.500	300.000	20.000	6.500	1300.00	0.04 s
FD-8A Relay	50:1	Ground	OC1					0.210	10.50	0.1 s
8CAT01 Relay	1000:1	Phase	OC1	IEC - Normal Inverse	1.000	1000.000	0.150	8.200	8200.00	0.04 s
8CAT01 Relay	50:1	Ground	OC1					0.400	20.00	0.2 s
US-8B IC Relay	2500:1	Phase	OC1	IEC - Standard Inverse	1.000	2500.000	0.275			
US-8B IC Relay	2500:1	Ground	OC1					0.080	200.00	0.5 s
FD-8B Relay	250:1	Phase	OC1	Definite Time	1.500	375.000	20.000	6.500	1625.00	0.04 s
FD-8B Relay	50:1	Ground	OC1					0.210	10.50	0.1 s
8CAT02 Relay	1000:1	Phase	OC1	IEC - Normal Inverse	1.000	1000.000	0.150	8.200	8200.00	0.04 s
8CAT02 Relay	50:1	Ground	OC1					0.400	20.00	0.2 s
PAF-8B Relay	250:1	Phase	OC1	Definite Time	1.500	375.000	28.000	6.500	1625.00	0.04 s
PAF-8B Relay	50:1	Ground	OC1					0.390	19.50	0.1 s
IDF-8B Relay	300:1	Phase	OC1	Definite Time	1.500	450.000	30.400	6.500	1950.00	0.04 s
IDF-8B Relay	50:1	Ground	OC1					0.500	25.00	0.1 s
CW-8C Relay	200:1	Phase	OC1	Definite Time	1.500	300.000	14.400	6.500	1300.00	0.04 s
CW-8C Relay	50:1	Ground	OC1					0.340	17.00	0.1 s
8DDT02 Relay	100:1	Phase	OC1	IEC - Normal Inverse	1.000	100.000	0.350	13.700	1370.00	0.04 s
8DDT02 Relay	50:1	Ground	OC1					0.200	10.00	0.2 s
8DET02 Relay	100:1	Phase	OC1	IEC - Normal Inverse	1.000	100.000	0.350	13.700	1370.00	0.04 s
8DET02 Relay	50:1	Ground	OC1					0.200	10.00	0.2 s

Relay ID	CT Ratio	Trip Element	Level	Curve	Tap (Pickup)		Time Dial / Mult.	Instantaneous		Inst. Delay
					Setting	Primary	Setting	Settings	Primary	Setting
8DFT02 Relay	100:1	Phase	OC1	IEC - Normal Inverse	1.000	100.000	0.350	13.700	1370.00	0.04 s
8DFT02 Relay	50:1	Ground	OC1					0.200	10.00	0.2 s
8DAT02 Relay	150:1	Phase	OC1	IEC - Normal Inverse	1.000	150.000	0.320	11.400	1710.00	0.04 s
8DAT02 Relay	50:1	Ground	OC1					0.200	10.00	0.2 s
8DBT02 Relay	150:1	Phase	OC1	IEC - Normal Inverse	1.000	150.000	0.400	11.400	1710.00	0.04 s
8DBT02 Relay	50:1	Ground	OC1					0.200	10.00	0.2 s
8DCT02 Relay	100:1	Phase	OC1	IEC - Normal Inverse	1.000	100.000	0.350	13.700	1370.00	0.04 s
8DCT02 Relay	50:1	Ground	OC1					0.200	10.00	0.2 s
US7A SS8C Tie Relay	2500:1	Phase	OC1	IEC - Standard Inverse	1.000	2500.000	0.325			
US7A SS8C Tie Relay	2500:1	Neutral	OC1					0.080	200.00	0.5 s
US8A SS7C Tie Relay	2500:1	Phase	OC1	IEC - Standard Inverse	1.000	2500.000	0.325			
US8A SS7C Tie Relay	2500:1	Ground	OC1					0.080	200.00	0.5 s
US7B SS8D Tie Relay	2500:1	Phase	OC1	IEC - Standard Inverse	1.000	2500.000	0.325			
US7B SS8D Tie Relay	2500:1	Ground	OC1					0.080	200.00	0.5 s
US8B SS7D Tie Relay	2500:1	Phase	OC1	IEC - Standard Inverse	1.000	2500.000	0.325			
US8B SS7D Tie Relay	2500:1	Ground	OC1					0.080	200.00	0.5 s
SS7C SS8C Tie Relay	3500:1	Phase	OC1	IEC - Standard Inverse	1.000	3500.000	0.325			
SS7C SS8C Tie Relay	3500:1	Ground	OC1					0.080	280.00	0.7 s
SS7C US8A Tie Relay	2500:1	Phase	OC1	IEC - Standard Inverse	1.000	2500.000	0.325			
SS7C US8A Tie Relay	2500:1	Ground	OC1					0.080	200.00	0.5 s
SS8C US7A Tie Relay	2500:1	Phase	OC1	IEC - Standard Inverse	1.000	2500.000	0.325			
SS8C US7A Tie Relay	2500:1	Ground	OC1					0.080	200.00	0.5 s
SS8C SS7C Tie Relay	3500:1	Phase	OC1	IEC - Standard Inverse	1.000	3500.000	0.325			
SS8C SS7C Tie Relay	3500:1	Ground	OC1					0.080	280.00	0.7 s
SS7D US8B Tie Relay	2500:1	Phase	OC1	IEC - Standard Inverse	1.000	2500.000	0.325			
SS7D US8B Tie Relay	2500:1	Ground	OC1					0.080	200.00	0.5 s
SS8D US7B Tie Relay	2500:1	Phase	OC1	IEC - Standard Inverse	1.000	2500.000	0.325			
SS8D US7B Tie Relay	2500:1	Ground	OC1					0.080	200.00	0.5 s
SS7D SS8D Tie Relay	3500:1	Phase	OC1	IEC - Standard Inverse	1.000	3500.000	0.300			
SS7D SS8D Tie Relay	3500:1	Ground	OC1					0.080	280.00	0.7 s
SS8D SS7D Tie Relay	3500:1	Phase	OC1	IEC - Standard Inverse	1.000	3500.000	0.300			
SS8D SS7D Tie Relay	3500:1	Ground	OC1					0.080	280.00	0.7 s
ST-7 LT-1 Relay	3500:1	Phase	OC1	IEC - Inverse	2.000	7000.000	0.500	1.500	5250.00	1.5 s
ST-7 LT-1 Relay	3500:1	Phase	OC2					5.000	17500.00	0.1 s

Relay ID	CT Ratio	Trip Element	Level	Curve	Tap (Pickup)		Time Dial / Mult.	Instantaneous		Inst. Delay
					Setting	Primary	Setting	Settings	Primary	Setting
ST-7 LT-1 Relay	200:1	Ground	OC1					0.550	110.00	1.2 s
ST-7 LT-2 Relay	3500:1	Phase	OC1	IEC - Inverse	2.000	7000.000	0.500	1.500	5250.00	1.5 s
ST-7 LT-2 Relay	3500:1	Phase	OC2					5.000	17500.00	0.1 s
ST-7 LT-2 Relay	200:1	Ground	OC1					0.550	110.00	1.2 s
ST-8 LT-1 Relay	3500:1	Phase	OC1	IEC - Inverse	2.000	7000.000	0.500	1.500	5250.00	1.5 s
ST-8 LT-1 Relay	3500:1	Phase	OC2					5.000	17500.00	0.1 s
ST-8 LT-1 Relay	3500:1	Neutral	OC1					0.550	1925.00	1.2 s
ST-8 LT-2 Relay	3500:1	Phase	OC1	IEC - Inverse	2.000	7000.000	0.500	1.500	5250.00	1.5 s
ST-8 LT-2 Relay	3500:1	Phase	OC2					5.000	17500.00	0.1 s
ST-8 LT-2 Relay	200:1	Ground	OC1					0.550	110.00	1.2 s
UT-7A LT Relay	2500:1	Phase	OC1	IEC - Inverse	4.000	10000.000	0.500	1.500	3750.00	1.5 s
UT-7A LT Relay	2500:1	Phase	OC2					10.000	25000.00	0.1 s
UT-7A LT Relay	200:1	Ground	OC1	IEC - Inverse	4.000	800.000	0.500	0.550	110.00	1.5 s
UT-7A LT Relay	200:1	Ground	OC2					0.550	110.00	1.2 s
UT-7B LT Relay	2500:1	Phase	OC1	IEC - Inverse	4.000	10000.000	0.500	1.500	3750.00	1.5 s
UT-7B LT Relay	2500:1	Phase	OC2					10.000	25000.00	0.1 s
UT-7B LT Relay	200:1	Ground	OC1	IEC - Inverse	4.000	800.000	0.500	0.550	110.00	1.5 s
UT-7B LT Relay	200:1	Ground	OC2					0.550	110.00	1.2 s
UT-8B LT Relay	2500:1	Phase	OC1	IEC - Inverse	4.000	10000.000	0.500	1.500	3750.00	1.5 s
UT-8B LT Relay	2500:1	Phase	OC2					10.000	25000.00	0.1 s
UT-8B LT Relay	200:1	Ground	OC1	IEC - Inverse	4.000	800.000	0.500	0.550	110.00	1.5 s
UT-8B LT Relay	200:1	Ground	OC2					0.550	110.00	1.2 s
UT-8A LT Relay	2500:1	Phase	OC1	IEC - Inverse	4.000	10000.000	0.500	1.500	3750.00	1.5 s
UT-8A LT Relay	2500:1	Phase	OC2					10.000	25000.00	0.1 s
UT-8A LT Relay	200:1	Ground	OC1	IEC - Inverse	4.000	800.000	0.500	0.550	110.00	1.5 s
UT-8A LT Relay	200:1	Ground	OC2					0.550	110.00	1.2 s



### Recommended Settings

Relay ID	CT Ratio	Trip Element	Level	Curve	Tap (Pickup)		Time Dial / Mult.	Instantaneous		Inst. Delay
					Setting	Primary	Setting	Settings	Primary	Setting
US-7A IC Relay	2500:1	Phase	OC1	IEC - Standard Inverse	1.000	2500.000	0.375			
US-7A IC Relay	2500:1	Neutral	OC1					0.100	250.00	0.4 s
7DAT01 Relay	150:1	Phase	OC1	IEC - Normal Inverse	1.000	150.000	0.300	5.400	810.00	0.25 s
7DAT01 Relay	150:1	Phase	OC2					11.400	1710.00	0.04 s
7DAT01 Relay	50:1	Ground	OC1	IEC - Normal Inverse	0.300	15.000	0.100	2.000	100.00	0.2 s
7DBT01 Relay	150:1	Phase	OC1	IEC - Normal Inverse	1.000	150.000	0.300	5.400	810.00	0.25 s
7DBT01 Relay	150:1	Phase	OC2					11.400	1710.00	0.04 s
7DBT01 Relay	50:1	Ground	OC1	IEC - Normal Inverse	0.300	15.000	0.100	2.000	100.00	0.2 s
7DCT01 Relay	100:1	Phase	OC1	IEC - Normal Inverse	1.000	100.000	0.300	5.100	510.00	0.25 s
7DCT01 Relay	100:1	Phase	OC2					13.700	1370.00	0.04 s
7DCT01 Relay	50:1	Ground	OC1	IEC - Normal Inverse	0.400	20.000	0.100	2.400	120.00	0.2 s
7DDT01 Relay	100:1	Phase	OC1	IEC - Normal Inverse	1.000	100.000	0.300	5.100	510.00	0.25 s
7DDT01 Relay	100:1	Phase	OC2					13.700	1370.00	0.04 s
7DDT01 Relay	100:1	Neutral	OC2					8.000	800.00	0.1 s
7DDT01 Relay	50:1	Ground	OC1	IEC - Normal Inverse	0.400	20.000	0.100	2.400	120.00	0.2 s
7DDT01 Relay	50:1	Sensitive Ground	OC2					8.000	400.00	0.08 s
7DET01 Relay	100:1	Phase	OC1	IEC - Normal Inverse	1.000	100.000	0.300	5.100	510.00	0.25 s
7DET01 Relay	100:1	Phase	OC2					13.700	1370.00	0.04 s
7DET01 Relay	50:1	Ground	OC1	IEC - Normal Inverse	0.400	20.000	0.100	2.400	120.00	0.2 s
7DFT01 Relay	100:1	Phase	OC1	IEC - Normal Inverse	1.000	100.000	0.300	5.100	510.00	0.25 s
7DFT01 Relay	100:1	Phase	OC2					13.700	1370.00	0.04 s
7DFT01 Relay	50:1	Ground	OC1	IEC - Normal Inverse	0.400	20.000	0.100	2.400	120.00	0.2 s
PAF-7A Relay	250:1	Phase	OC1	Definite Time	1.500	375.000	28.000	6.500	1625.00	0.04 s
PAF-7A Relay	50:1	Ground	OC1					0.390	19.50	0.1 s

Relay ID	CT Ratio	Trip Element	Level	Curve	Tap (Pickup)		Time Dial / Mult.	Instantaneous		Inst. Delay
					Setting	Primary	Setting	Settings	Primary	Setting
IDF-7A Relay	300:1	Phase	OC1	Definite Time	1.500	450.000	30.400	6.500	1950.00	0.04 s
IDF-7A Relay	50:1	Ground	OC1					0.500	25.00	0.1 s
CW-7A Relay	200:1	Phase	OC1	Definite Time	1.500	300.000	14.400	6.500	1300.00	0.04 s
CW-7A Relay	50:1	Ground	OC1					0.340	17.00	0.1 s
CW-7B Relay	200:1	Phase	OC1	Definite Time	1.500	300.000	14.400	6.500	1300.00	0.04 s
CW-7B Relay	50:1	Ground	OC1					0.340	17.00	0.1 s
FD-7A Relay	200:1	Phase	OC1	Definite Time	1.500	300.000	20.000	6.500	1300.00	0.04 s
FD-7A Relay	50:1	Ground	OC1					0.210	10.50	0.1 s
7CAT01 Relay	1000:1	Phase	OC1	IEC - Normal Inverse	1.000	1000.000	0.220	4.800	4800.00	0.25 s
7CAT01 Relay	1000:1	Phase	OC2					8.200	8200.00	0.04 s
7CAT01 Relay	50:1	Ground	OC1	IEC - Normal Inverse	2.000	100.000	0.100	4.000	200.00	0.2 s
US-7B IC Relay	2500:1	Phase	OC1	IEC - Standard Inverse	1.000	2500.000	0.350			
US-7B IC Relay	2500:1	Ground	OC1					0.080	200.00	0.5 s
7DAT02 Relay	150:1	Phase	OC1	IEC - Normal Inverse	1.000	150.000	0.300	5.400	810.00	0.25 s
7DAT02 Relay	150:1	Phase	OC2					11.400	1710.00	0.04 s
7DAT02 Relay	50:1	Ground	OC1	IEC - Normal Inverse	0.300	15.000	0.100	2.000	100.00	0.2 s
7DBT02 Relay	150:1	Phase	OC1	IEC - Normal Inverse	1.000	150.000	0.300	5.400	810.00	0.25 s
7DBT02 Relay	150:1	Phase	OC2					11.400	1710.00	0.04 s
7DBT02 Relay	50:1	Ground	OC1	IEC - Normal Inverse	0.300	15.000	0.100	2.000	100.00	0.2 s
7DCT02 Relay	100:1	Phase	OC1	IEC - Normal Inverse	1.000	100.000	0.300	5.100	510.00	0.25 s
7DCT02 Relay	100:1	Phase	OC2					13.700	1370.00	0.04 s
7DCT02 Relay	50:1	Ground	OC1	IEC - Normal Inverse	0.400	20.000	0.100	2.400	120.00	0.2 s
7DDT02 Relay	100:1	Phase	OC1	IEC - Normal Inverse	1.000	100.000	0.300	5.100	510.00	0.25 s
7DDT02 Relay	100:1	Phase	OC2					13.700	1370.00	0.04 s
7DDT02 Relay	50:1	Ground	OC1	IEC - Normal Inverse	0.400	20.000	0.100	2.400	120.00	0.2 s
7DET02 Relay	100:1	Phase	OC1	IEC - Normal Inverse	1.000	100.000	0.300	5.100	510.00	0.25 s



Relay ID	CT Ratio	Trip Element	Level	Curve	Tap (Pickup)		Time Dial / Mult.	Instantaneous		Inst. Delay
					Setting	Primary	Setting	Settings	Primary	Setting
7DET02 Relay	100:1	Phase	OC2					13.700	1370.00	0.04 s
7DET02 Relay	50:1	Ground	OC1	IEC - Normal Inverse	0.400	20.000	0.100	2.400	120.00	0.2 s
7DFT02 Relay	100:1	Phase	OC1	IEC - Normal Inverse	1.000	100.000	0.300	5.100	510.00	0.25 s
7DFT02 Relay	100:1	Phase	OC2					13.700	1370.00	0.04 s
7DFT02 Relay	50:1	Ground	OC1	IEC - Normal Inverse	0.400	20.000	0.100	2.400	120.00	0.2 s
PAF-7B Relay	250:1	Phase	OC1	Definite Time	1.500	375.000	28.000	6.500	1625.00	0.04 s
PAF-7B Relay	50:1	Ground	OC1					0.390	19.50	0.1 s
IDF-7B Relay	300:1	Phase	OC1	Definite Time	1.500	450.000	30.400	6.500	1950.00	0.04 s
IDF-7B Relay	50:1	Ground	OC1					0.500	25.00	0.1 s
CW-7C Relay	250:1	Phase	OC1	Definite Time	1.500	375.000	14.400	6.500	1625.00	0.04 s
CW-7C Relay	50:1	Ground	OC1					0.340	17.00	0.1 s
CW-7D Relay	250:1	Phase	OC1	Definite Time	1.500	375.000	14.400	6.500	1625.00	0.04 s
CW-7D Relay	50:1	Ground	OC1					0.340	17.00	0.1 s
FD-7B Relay	200:1	Phase	OC1	Definite Time	1.500	300.000	20.000	6.500	1300.00	0.04 s
FD-7B Relay	50:1	Ground	OC1					0.210	10.50	0.1 s
7CAT02 Relay	1000:1	Phase	OC1	IEC - Normal Inverse	1.000	1000.000	0.220	4.800	4800.00	0.25 s
7CAT02 Relay	1000:1	Phase	OC2					8.200	8200.00	0.04 s
7CAT02 Relay	50:1	Ground	OC1	IEC - Normal Inverse	2.000	100.000	0.100	4.000	200.00	0.2 s
SS-7C IC Relay	3500:1	Phase	OC1	IEC - Standard Inverse	1.000	3500.000	0.400			
SS-7C IC Relay	3500:1	Ground	OC1					0.080	280.00	0.9 s
OCAT01 Relay	2500:1	Phase	OC1	IEC - Normal Inverse	1.000	2500.000	0.330	4.200	10500.00	0.25 s
OCAT01 Relay	2500:1	Phase	OC2					9.100	22750.00	0.04 s
OCAT01 Relay	50:1	Ground	OC1	IEC - Normal Inverse	2.000	100.000	0.200	5.500	275.00	0.2 s
ODET01 Relay	75:1	Phase	OC1	IEC - Normal Inverse	1.000	75.000	0.210	4.000	300.00	0.25 s
ODET01 Relay	75:1	Phase	OC2					8.000	600.00	0.04 s
ODET01 Relay	50:1	Ground	OC1	IEC - Normal Inverse	0.200	10.000	0.100	0.800	40.00	0.2 s

Relay ID	CT Ratio	Trip Element	Level	Curve	Tap (Pickup)		Time Dial / Mult.	Instantaneous		Inst. Delay
					Setting	Primary	Setting	Settings	Primary	Setting
SW SRV TRF1 Relay	50:1	Phase	OC1	IEC - Normal Inverse	1.000	50.000	0.270			
SW SRV TRF1 Relay	50:1	Ground	OC1					0.200	10.00	0.2 s
MDBFP-7A Relay1	250:1	Phase	OC1	Definite Time	1.500	375.000	20.800	6.500	1625.00	0.04 s
MDBFP-7A Relay1	50:1	Ground	OC1					2.090	104.50	0.1 s
MDBFP-7A Relay2	250:1	Phase	OC1	Definite Time	1.500	375.000	20.800	6.500	1625.00	0.04 s
MDBFP-7A Relay2	50:1	Ground	OC1					2.090	104.50	0.1 s
OCCT01 Relay	150:1	Phase	OC1	IEC - Normal Inverse	1.000	150.000	0.240	4.200	630.00	0.25 s
OCCT01 Relay	150:1	Phase	OC2					9.000	1350.00	0.04 s
OCCT01 Relay	50:1	Ground	OC1	IEC - Normal Inverse	0.400	20.000	0.100	1.600	80.00	0.2 s
OCDT01 Relay	800:1	Phase	OC1	IEC - Normal Inverse	1.000	800.000	0.300	4.500	3600.00	0.25 s
OCDT01 Relay	800:1	Phase	OC2					10.700	8560.00	0.04 s
OCDT01 Relay	50:1	Ground	OC1	IEC - Normal Inverse	1.000	50.000	0.100	4.000	200.00	0.2 s
ODAT01 Relay	150:1	Phase	OC1	IEC - Normal Inverse	1.000	150.000	0.300	5.400	810.00	0.25 s
ODAT01 Relay	150:1	Phase	OC2					11.400	1710.00	0.04 s
ODAT01 Relay	50:1	Ground	OC1	IEC - Normal Inverse	0.300	15.000	0.100	2.000	100.00	0.2 s
Coln Fdr1 Relay	150:1	Phase	OC1	IEC - Extremely Inverse	0.100	15.000	0.050	4.000	600.00	0.04 s
Coln Fdr1 Relay	150:1	Neutral	OC1	IEC - Extremely Inverse	0.010	1.500	0.050	8.000	1200.00	0.1 s
Coln Fdr1 Relay	150:1	Ground	OC1	IEC - Extremely Inverse	0.005	0.750	0.050			
Coln Fdr1 Relay	150:1	Sensitive Ground	OC1	IEC - Extremely Inverse	0.010	1.500	0.050	8.000	1200.00	0.08 s
Coln Fdr1 Relay	150:1	Phase		Thermal Overload	0.500	75.000	2.000			

Relay ID	CT Ratio	Trip Element	Level	Curve	Tap (Pickup)		Time Dial / Mult.	Instantaneous		Inst. Delay
					Setting	Primary	Setting	Settings	Primary	Setting
ODDT01 Relay	50:1	Phase	OC1	IEC - Normal Inverse	0.800	40.000	0.220	4.000	200.00	0.25 s
ODDT01 Relay	50:1	Phase	OC2					14.400	720.00	0.04 s
ODDT01 Relay	50:1	Ground	OC1	IEC - Normal Inverse	0.140	7.000	0.100	0.600	30.00	0.2 s
ODCT01 Relay	100:1	Phase	OC1	IEC - Normal Inverse	1.000	100.000	0.300	5.100	510.00	0.25 s
ODCT01 Relay	100:1	Phase	OC2					13.700	1370.00	0.04 s
ODCT01 Relay	50:1	Ground	OC1	IEC - Normal Inverse	0.400	20.000	0.100	2.400	120.00	0.2 s
ODBT01 Relay	150:1	Phase	OC1	IEC - Normal Inverse	1.000	150.000	0.300	5.400	810.00	0.25 s
ODBT01 Relay	150:1	Phase	OC2					11.400	1710.00	0.04 s
ODBT01 Relay	50:1	Ground	OC1	IEC - Normal Inverse	0.300	15.000	0.100	2.000	100.00	0.2 s
OCBT01 Relay	250:1	Phase	OC1	IEC - Normal Inverse	1.000	250.000	0.320	4.500	1125.00	0.25 s
OCBT01 Relay	250:1	Phase	OC2					15.900	3975.00	0.04 s
OCBT01 Relay	50:1	Ground	OC1	IEC - Normal Inverse	0.600	30.000	0.100	3.000	150.00	0.2 s
OCAT02 Relay	2500:1	Phase	OC1	IEC - Normal Inverse	1.000	2500.000	0.330	4.200	10500.00	0.25 s
OCAT02 Relay	2500:1	Phase	OC2					9.100	22750.00	0.04 s
OCAT02 Relay	50:1	Ground	OC1	IEC - Normal Inverse	2.000	100.000	0.200	5.500	275.00	0.2 s
ODET02 Relay	75:1	Phase	OC1	IEC - Normal Inverse	1.000	75.000	0.210	4.000	300.00	0.25 s
ODET02 Relay	75:1	Phase	OC2					8.000	600.00	0.04 s
ODET02 Relay	50:1	Ground	OC1	IEC - Normal Inverse	0.200	10.000	0.100	0.800	40.00	0.2 s
SW SRV TRF2 Relay	50:1	Phase	OC1	IEC - Normal Inverse	1.000	50.000	0.270			
SW SRV TRF2 Relay	50:1	Ground	OC1					0.200	10.00	0.2 s
MDBFP-8A Relay1	250:1	Phase	OC1	Definite Time	1.500	375.000	20.800	6.500	1625.00	0.04 s
MDBFP-8A Relay1	50:1	Ground	OC1					2.090	104.50	0.1 s
MDBFP-8A Relay2	250:1	Phase	OC1	Definite Time	1.500	375.000	20.800	6.500	1625.00	0.04 s

Relay ID	CT Ratio	Trip Element	Level	Curve	Tap (Pickup)		Time Dial / Mult.	Instantaneous		Inst. Delay
					Setting	Primary	Setting	Settings	Primary	Setting
MDBFP-8A Relay2	50:1	Ground	OC1					2.090	104.50	0.1 s
ODDT02 Relay	50:1	Phase	OC1	IEC - Normal Inverse	1.000	50.000	0.220	4.000	200.00	0.25 s
ODDT02 Relay	50:1	Phase	OC2					14.400	720.00	0.04 s
ODDT02 Relay	50:1	Ground	OC1	IEC - Normal Inverse	0.140	7.000	0.100	0.600	30.00	0.2 s
OCBT02 Relay	250:1	Phase	OC1	IEC - Normal Inverse	1.000	250.000	0.320	4.500	1125.00	0.25 s
OCBT02 Relay	250:1	Phase	OC2					15.900	3975.00	0.04 s
OCBT02 Relay	50:1	Ground	OC1	IEC - Normal Inverse	0.600	30.000	0.100	3.000	150.00	0.2 s
Coln Fdr2 Relay	150:1	Phase	OC1	IEC - Extremely Inverse	0.100	15.000	0.050	4.000	600.00	0.04 s
Coln Fdr2 Relay	150:1	Neutral	OC1	IEC - Extremely Inverse	0.010	1.500	0.050	8.000	1200.00	0.1 s
Coln Fdr2 Relay	150:1	Ground	OC1	IEC - Extremely Inverse	0.005	0.750	0.050			
Coln Fdr2 Relay	150:1	Sensitive Ground	OC1	IEC - Extremely Inverse	0.010	1.500	0.050	8.000	1200.00	0.08 s
Coln Fdr2 Relay	150:1	Phase		Thermal Overload	0.500	75.000	2.000			
ODAT02 Relay	150:1	Phase	OC1	IEC - Normal Inverse	1.000	150.000	0.300	5.400	810.00	0.25 s
ODAT02 Relay	150:1	Phase	OC2					11.400	1710.00	0.04 s
ODAT02 Relay	50:1	Ground	OC1	IEC - Normal Inverse	0.300	15.000	0.100	2.000	100.00	0.2 s
ODCT02 Relay	800:1	Phase	OC1	IEC - Normal Inverse	1.000	800.000	0.300	5.100	4080.00	0.25 s
ODCT02 Relay	800:1	Phase	OC2					13.700	10960.00	0.04 s
ODCT02 Relay	50:1	Ground	OC1	IEC - Normal Inverse	0.400	20.000	0.100	2.400	120.00	0.2 s
ODBT02 Relay	150:1	Phase	OC1	IEC - Normal Inverse	1.000	150.000	0.300	5.400	810.00	0.25 s
ODBT02 Relay	150:1	Phase	OC2					11.400	1710.00	0.04 s
ODBT02 Relay	50:1	Ground	OC1	IEC - Normal Inverse	0.300	15.000	0.100	2.000	100.00	0.2 s
OCCT02 Relay	150:1	Phase	OC1	IEC - Normal Inverse	1.000	150.000	0.240	4.200	630.00	0.25 s
OCCT02 Relay	150:1	Phase	OC2					15.200	2280.00	0.04 s

Relay ID	CT Ratio	Trip Element	Level	Curve	Tap (Pickup)		Time Dial / Mult.	Instantaneous		Inst. Delay
					Setting	Primary		Settings	Primary	
OCCT02 Relay	50:1	Ground	OC1	IEC - Normal Inverse	0.400	20.000	0.100	1.600	80.00	0.2 s
OCDT02 Relay	800:1	Phase	OC1	IEC - Normal Inverse	1.000	800.000	0.300	4.500	3600.00	0.25 s
OCDT02 Relay	800:1	Phase	OC2					10.700	8560.00	0.04 s
OCDT02 Relay	50:1	Ground	OC1	IEC - Normal Inverse	1.000	50.000	0.200	4.000	200.00	0.2 s
SS-7D IC Relay	3500:1	Phase	OC1	IEC - Standard Inverse	1.000	3500.000	0.375			
SS-7D IC Relay	3500:1	Ground	OC1					0.080	280.00	0.9 s
SS-8C IC Relay	3500:1	Phase	OC1	IEC - Standard Inverse	1.000	3500.000	0.400			
SS-8C IC Relay	3500:1	Ground	OC1					0.080	280.00	0.9 s
SS-8D IC Relay	2500:1	Phase	OC1	IEC - Standard Inverse	1.000	2500.000	0.375			
SS-8D IC Relay	2500:1	Ground	OC1					0.080	200.00	0.9 s
US-8A IC Relay	2500:1	Phase	OC1	IEC - Standard Inverse	1.000	2500.000	0.375			
US-8A IC Relay	2500:1	Ground	OC1					0.100	250.00	0.4 s
8DAT01 Relay	150:1	Phase	OC1	IEC - Normal Inverse	1.000	150.000	0.300	5.100	765.00	0.25 s
8DAT01 Relay	150:1	Phase	OC2					11.400	1710.00	0.04 s
8DAT01 Relay	150:1	Neutral	OC2					8.000	1200.00	0.1 s
8DAT01 Relay	50:1	Ground	OC1					0.200	10.00	0.2 s
8DAT01 Relay	50:1	Sensitive Ground	OC2					8.000	400.00	0.08 s
8DBT01 Relay	150:1	Phase	OC1	IEC - Normal Inverse	1.000	150.000	0.300	5.400	810.00	0.25 s
8DBT01 Relay	150:1	Phase	OC2					11.400	1710.00	0.04 s
8DBT01 Relay	50:1	Ground	OC1					0.200	10.00	0.2 s
8DCT01 Relay	100:1	Phase	OC1	IEC - Normal Inverse	1.000	100.000	0.300	5.100	510.00	0.25 s
8DCT01 Relay	100:1	Phase	OC2					13.700	1370.00	0.04 s
8DCT01 Relay	50:1	Ground	OC1	IEC - Normal Inverse	0.400	20.000	0.100	2.400	120.00	0.2 s
8DDT01 Relay	100:1	Phase	OC1	IEC - Normal Inverse	1.000	100.000	0.300	5.100	510.00	0.25 s
8DDT01 Relay	100:1	Phase	OC2					13.700	1370.00	0.04 s

Relay ID	CT Ratio	Trip Element	Level	Curve	Tap (Pickup)		Time Dial / Mult.	Instantaneous		Inst. Delay
					Setting	Primary	Setting	Settings	Primary	Setting
8DDT01 Relay	50:1	Ground	OC1	IEC - Normal Inverse	0.400	20.000	0.100	2.400	120.00	0.2 s
8DET01 Relay	100:1	Phase	OC1	IEC - Normal Inverse	1.000	100.000	0.300	5.100	510.00	0.25 s
8DET01 Relay	100:1	Phase	OC2					13.700	1370.00	0.04 s
8DET01 Relay	50:1	Ground	OC1	IEC - Normal Inverse	0.400	20.000	0.100	2.400	120.00	0.2 s
8DFT01 Relay	100:1	Phase	OC1	IEC - Normal Inverse	1.000	100.000	0.300	5.100	510.00	0.25 s
8DFT01 Relay	100:1	Phase	OC2					13.700	1370.00	0.04 s
8DFT01 Relay	50:1	Ground	OC1	IEC - Normal Inverse	0.400	20.000	0.100	2.400	120.00	0.2 s
PAF-8A Relay	250:1	Phase	OC1	Definite Time	1.500	375.000	28.000	6.500	1625.00	0.04 s
PAF-8A Relay	50:1	Ground	OC1					0.390	19.50	0.1 s
IDF-8A Relay	300:1	Phase	OC1	Definite Time	1.500	450.000	30.400	6.500	1950.00	0.04 s
IDF-8A Relay	50:1	Ground	OC1					0.500	25.00	0.1 s
CW-8A Relay	250:1	Phase	OC1	Definite Time	1.500	375.000	14.400	6.500	1625.00	0.04 s
CW-8A Relay	50:1	Ground	OC1					0.340	17.00	0.1 s
CW-8B Relay	250:1	Phase	OC1	Definite Time	1.500	375.000	14.400	6.500	1625.00	0.04 s
CW-8B Relay	50:1	Ground	OC1					0.340	17.00	0.1 s
FD-8A Relay	200:1	Phase	OC1	Definite Time	1.500	300.000	20.000	6.500	1300.00	0.04 s
FD-8A Relay	50:1	Ground	OC1					0.210	10.50	0.1 s
8CAT01 Relay	1000:1	Phase	OC1	IEC - Normal Inverse	1.000	1000.000	0.220	4.800	4800.00	0.25 s
8CAT01 Relay	1000:1	Phase	OC2					8.200	8200.00	0.04 s
8CAT01 Relay	50:1	Ground	OC1	IEC - Normal Inverse	2.000	100.000	0.100	4.000	200.00	0.2 s
US-8B IC Relay	2500:1	Phase	OC1	IEC - Standard Inverse	1.000	2500.000	0.350			
US-8B IC Relay	2500:1	Ground	OC1					0.080	200.00	0.5 s
FD-8B Relay	250:1	Phase	OC1	Definite Time	1.500	375.000	20.000	6.500	1625.00	0.04 s
FD-8B Relay	50:1	Ground	OC1					0.210	10.50	0.1 s
8CAT02 Relay	1000:1	Phase	OC1	IEC - Normal Inverse	0.910	910.000	0.150	4.800	4800.00	0.25 s
8CAT02 Relay	1000:1	Phase	OC2					8.200	8200.00	0.04 s

Relay ID	CT Ratio	Trip Element	Level	Curve	Tap (Pickup)		Time Dial / Mult.	Instantaneous		Inst. Delay
					Setting	Primary	Setting	Settings	Primary	Setting
8CAT02 Relay	50:1	Ground	OC1	IEC - Normal Inverse	2.000	100.000	0.100	4.000	200.00	0.2 s
PAF-8B Relay	250:1	Phase	OC1	Definite Time	1.500	375.000	28.000	6.500	1625.00	0.04 s
PAF-8B Relay	50:1	Ground	OC1					0.390	19.50	0.1 s
IDF-8B Relay	300:1	Phase	OC1	Definite Time	1.500	450.000	30.400	6.500	1950.00	0.04 s
IDF-8B Relay	50:1	Ground	OC1					0.500	25.00	0.1 s
CW-8C Relay	200:1	Phase	OC1	Definite Time	1.500	300.000	14.400	6.500	1300.00	0.04 s
CW-8C Relay	50:1	Ground	OC1					0.340	17.00	0.1 s
8DDT02 Relay	100:1	Phase	OC1	IEC - Normal Inverse	1.000	100.000	0.300	5.100	510.00	0.25 s
8DDT02 Relay	100:1	Phase	OC2					13.700	1370.00	0.04 s
8DDT02 Relay	50:1	Ground	OC1	IEC - Normal Inverse	0.400	20.000	0.100	2.400	120.00	0.2 s
8DET02 Relay	100:1	Phase	OC1	IEC - Normal Inverse	1.000	100.000	0.300	5.100	510.00	0.25 s
8DET02 Relay	100:1	Phase	OC2					13.700	1370.00	0.04 s
8DET02 Relay	100:1	Neutral	OC2					8.000	800.00	0.1 s
8DET02 Relay	50:1	Ground	OC1	IEC - Normal Inverse	0.400	20.000	0.100	2.400	120.00	0.2 s
8DET02 Relay	50:1	Sensitive Ground	OC2					8.000	400.00	0.08 s
8DFT02 Relay	100:1	Phase	OC1	IEC - Normal Inverse	1.000	100.000	0.300	5.100	510.00	0.25 s
8DFT02 Relay	100:1	Phase	OC2					13.700	1370.00	0.04 s
8DFT02 Relay	50:1	Ground	OC1	IEC - Normal Inverse	0.400	20.000	0.100	2.400	120.00	0.2 s
8DAT02 Relay	150:1	Phase	OC1	IEC - Normal Inverse	1.000	150.000	0.300	5.400	810.00	0.25 s
8DAT02 Relay	150:1	Phase	OC2					4.000	600.00	0.04 s
8DAT02 Relay	150:1	Neutral	OC2					8.000	1200.00	0.1 s
8DAT02 Relay	50:1	Ground	OC1					0.200	10.00	0.2 s
8DAT02 Relay	50:1	Sensitive Ground	OC2					8.000	400.00	0.08 s
8DBT02 Relay	150:1	Phase	OC1	IEC - Normal Inverse	1.000	150.000	0.300	5.400	810.00	0.25 s
8DBT02 Relay	150:1	Phase	OC2					11.400	1710.00	0.04 s



Relay ID	CT Ratio	Trip Element	Level	Curve	Tap (Pickup)		Time Dial / Mult.	Instantaneous		Inst. Delay
					Setting	Primary	Setting	Settings	Primary	Setting
8DBT02 Relay	150:1	Neutral	OC2					8.000	1200.00	0.1 s
8DBT02 Relay	50:1	Ground	OC1					0.200	10.00	0.2 s
8DBT02 Relay	50:1	Sensitive Ground	OC2					8.000	400.00	0.08 s
8DCT02 Relay	100:1	Phase	OC1	IEC - Normal Inverse	1.000	100.000	0.300	5.100	510.00	0.25 s
8DCT02 Relay	100:1	Phase	OC2					13.700	1370.00	0.04 s
8DCT02 Relay	50:1	Ground	OC1	IEC - Normal Inverse	0.400	20.000	0.100	2.400	120.00	0.2 s
US7A SS8C Tie Relay	2500:1	Phase	OC1	IEC - Standard Inverse	1.000	2500.000	0.325			
US7A SS8C Tie Relay	2500:1	Neutral	OC1					0.100	250.00	0.4 s
US8A SS7C Tie Relay	2500:1	Phase	OC1	IEC - Standard Inverse	1.000	2500.000	0.325			
US8A SS7C Tie Relay	2500:1	Neutral	OC1					0.100	250.00	0.4 s
US7B SS8D Tie Relay	2500:1	Phase	OC1	IEC - Standard Inverse	1.000	2500.000	0.325			
US7B SS8D Tie Relay	2500:1	Ground	OC1					0.080	200.00	0.5 s
US8B SS7D Tie Relay	2500:1	Phase	OC1	IEC - Standard Inverse	1.000	2500.000	0.325			
US8B SS7D Tie Relay	2500:1	Ground	OC1					0.080	200.00	0.5 s
SS7C SS8C Tie Relay	3500:1	Phase	OC1	IEC - Standard Inverse	1.000	3500.000	0.325			
SS7C SS8C Tie Relay	3500:1	Ground	OC1					0.080	280.00	0.7 s
SS7C US8A Tie Relay	2500:1	Phase	OC1	IEC - Standard Inverse	1.000	2500.000	0.325			
SS7C US8A Tie Relay	2500:1	Ground	OC1					0.080	200.00	0.5 s



Relay ID	CT Ratio	Trip Element	Level	Curve	Tap (Pickup)		Time Dial / Mult.	Instantaneous		Inst. Delay
					Setting	Primary	Setting	Settings	Primary	Setting
SS8C US7A Tie Relay	2500:1	Phase	OC1	IEC - Standard Inverse	1.000	2500.000	0.325			
SS8C US7A Tie Relay	2500:1	Ground	OC1					0.080	200.00	0.5 s
SS8C SS7C Tie Relay	3500:1	Phase	OC1	IEC - Standard Inverse	1.000	3500.000	0.325			
SS8C SS7C Tie Relay	3500:1	Ground	OC1					0.080	280.00	0.7 s
SS7D US8B Tie Relay	2500:1	Phase	OC1	IEC - Standard Inverse	1.000	2500.000	0.325			
SS7D US8B Tie Relay	2500:1	Ground	OC1					0.080	200.00	0.5 s
SS8D US7B Tie Relay	2500:1	Phase	OC1	IEC - Standard Inverse	1.000	2500.000	0.325			
SS8D US7B Tie Relay	2500:1	Ground	OC1					0.080	200.00	0.5 s
SS7D SS8D Tie Relay	3500:1	Phase	OC1	IEC - Standard Inverse	1.000	3500.000	0.300			
SS7D SS8D Tie Relay	3500:1	Ground	OC1					0.080	280.00	0.7 s
SS8D SS7D Tie Relay	3500:1	Phase	OC1	IEC - Standard Inverse	1.000	3500.000	0.300			
SS8D SS7D Tie Relay	3500:1	Ground	OC1					0.080	280.00	0.7 s
ST-7 LT-1 Relay	3500:1	Phase	OC1	IEC - Inverse	2.000	7000.000	0.500	5.000	17500.00	2 s
ST-7 LT-1 Relay	3500:1	Phase	OC2					10.500	36750.00	0.1 s
ST-7 LT-1 Relay	200:1	Ground	OC1					1.500	300.00	1.2 s
ST-7 LT-2 Relay	3500:1	Phase	OC1	IEC - Inverse	2.000	7000.000	0.500	5.000	17500.00	2 s
ST-7 LT-2 Relay	3500:1	Phase	OC2					10.500	36750.00	0.1 s
ST-7 LT-2 Relay	3500:1	Ground	OC1					1.500	5250.00	1.2 s
ST-8 LT-1 Relay	3500:1	Phase	OC1	IEC - Inverse	2.000	7000.000	0.500	5.000	17500.00	2 s

Relay ID	CT Ratio	Trip Element	Level	Curve	Tap (Pickup)		Time Dial / Mult.	Instantaneous		Inst. Delay
					Setting	Primary	Setting	Settings	Primary	Setting
ST-8 LT-1 Relay	3500:1	Phase	OC2					10.500	36750.00	0.1 s
ST-8 LT-1 Relay	200:1	Ground	OC1					1.500	300.00	1.2 s
ST-8 LT-2 Relay	3500:1	Phase	OC1	IEC - Inverse	2.000	7000.000	0.500	5.000	17500.00	2 s
ST-8 LT-2 Relay	3500:1	Phase	OC2					10.500	36750.00	0.1 s
ST-8 LT-2 Relay	3500:1	Ground	OC1					1.500	5250.00	1.2 s
UT-7A LT Relay	2500:1	Phase	OC1	IEC - Inverse	1.500	3750.000	0.500	7.500	18750.00	1.5 s
UT-7A LT Relay	2500:1	Phase	OC2					12.000	30000.00	0.1 s
UT-7A LT Relay	200:1	Ground	OC1					1.400	280.00	0.65 s
UT-7B LT Relay	2500:1	Phase	OC1	IEC - Inverse	1.500	3750.000	0.500	7.500	18750.00	1.5 s
UT-7B LT Relay	2500:1	Phase	OC2					12.000	30000.00	0.1 s
UT-7B LT Relay	200:1	Ground	OC1					1.400	280.00	0.65 s
UT-8B LT Relay	2500:1	Phase	OC1	IEC - Inverse	1.500	3750.000	0.500	7.500	18750.00	1.5 s
UT-8B LT Relay	2500:1	Phase	OC2					12.000	30000.00	0.1 s
UT-8B LT Relay	200:1	Ground	OC1					1.400	280.00	0.65 s
UT-8A LT Relay	2500:1	Phase	OC1	IEC - Inverse	1.500	3750.000	0.500	7.500	18750.00	1.5 s
UT-8A LT Relay	2500:1	Phase	OC2					12.000	30000.00	0.1 s
UT-8A LT Relay	200:1	Ground	OC1					1.400	280.00	0.65 s

# **8.4**

## **TCC curves with respect to recommended settings**

Amps X 100 US-7A (Nom. kV=11, Plot Ref. kV=11.528)

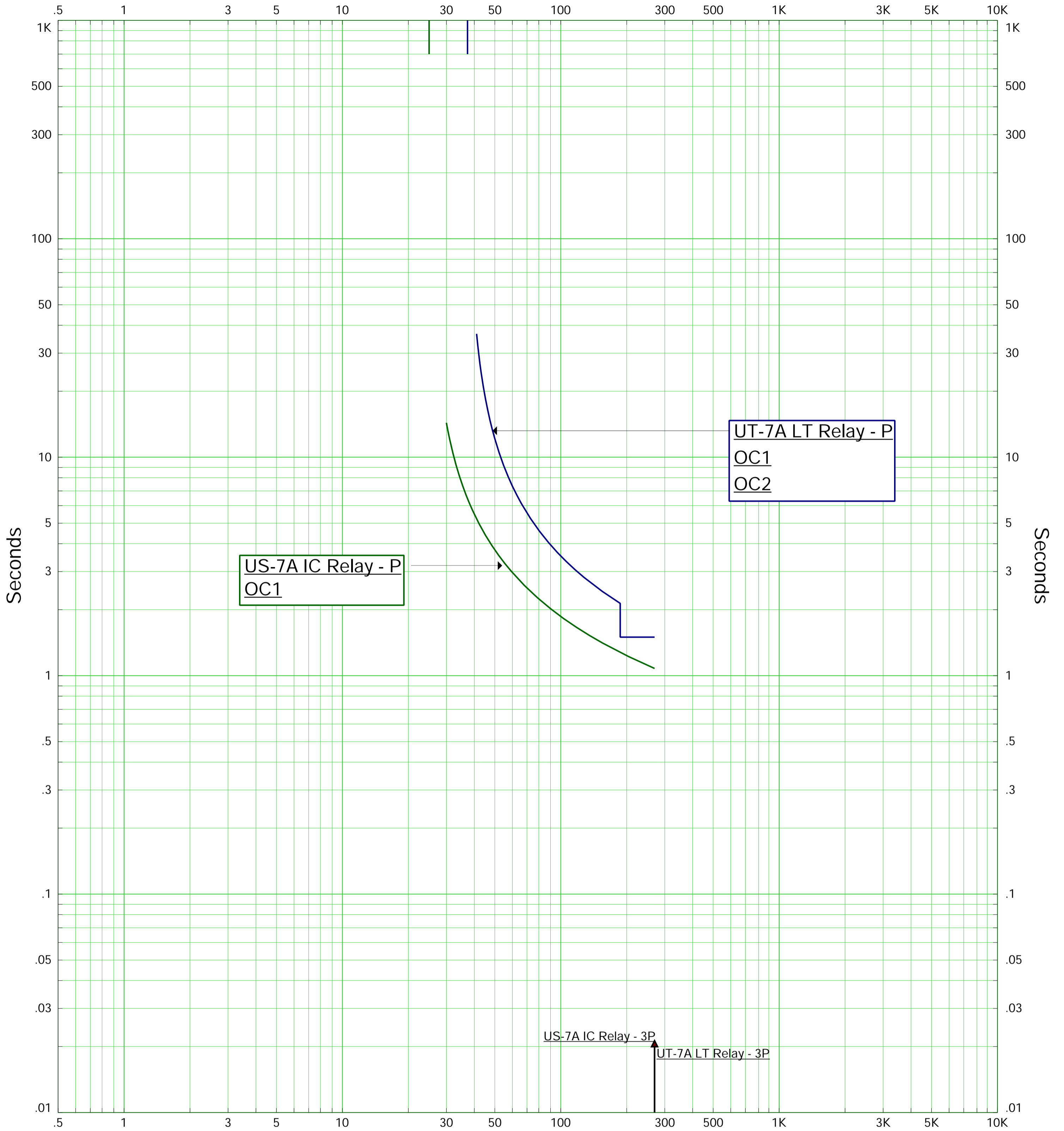

Amps X 100 US-7A (Nom. kV=11, Plot Ref. kV=11.528)

ETAP Star 20.6.0C

ERDA	<b>UT-7 LT TCC</b>	SSCTPS
		Rev: Base - RC1 Fault: Phase

Amps X 10 US-7A (Nom. kV=11, Plot Ref. kV=11.528)

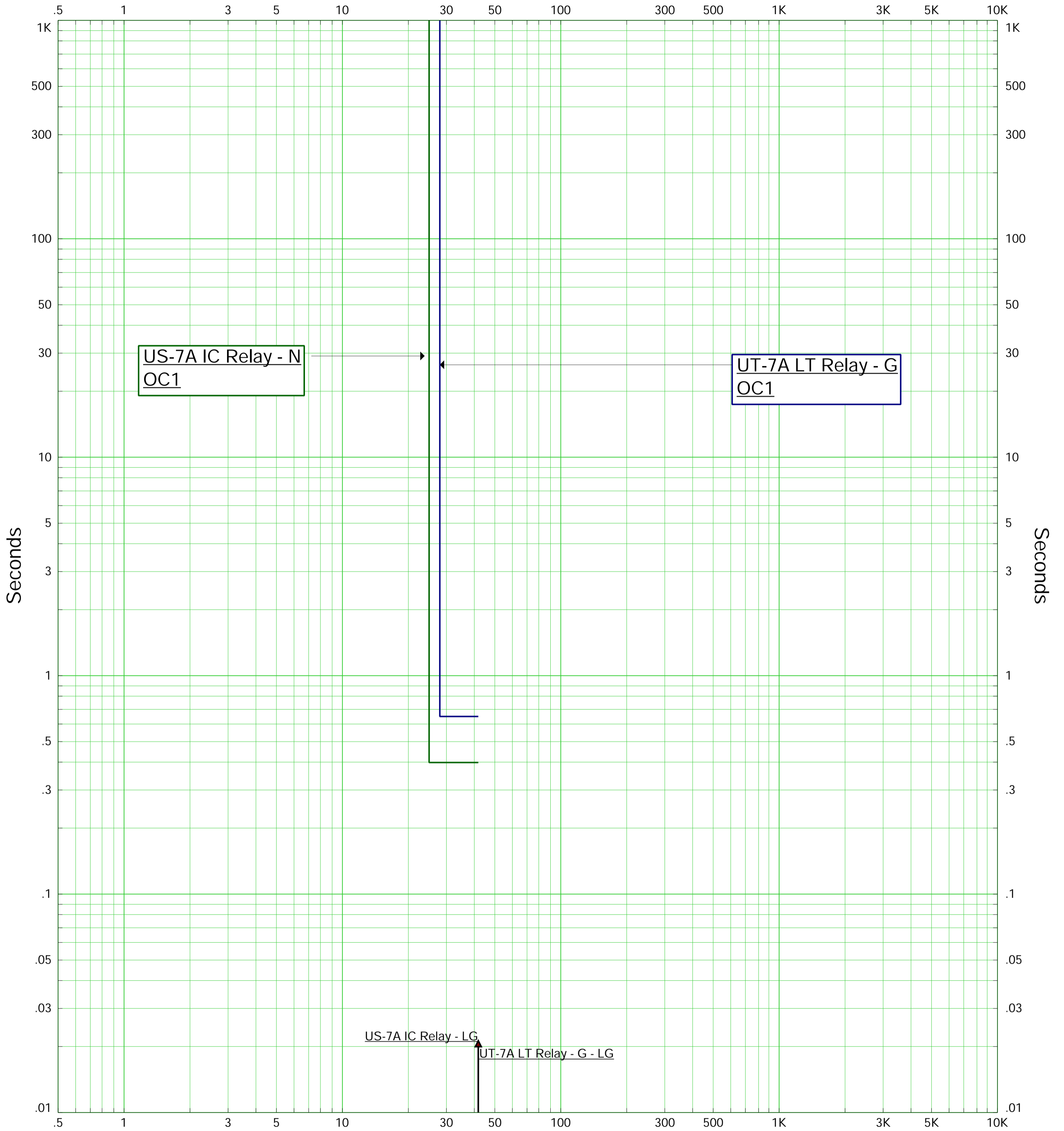

Amps X 10 US-7A (Nom. kV=11, Plot Ref. kV=11.528)

ETAP Star 20.6.0C

ERDA	<b>UT-7 LT TCC</b>	SSCTPS
		Rev: Base - RC1 Fault: Ground

Amps X 100 SS-7C (Nom. kV=11, Plot Ref. kV=11.233)

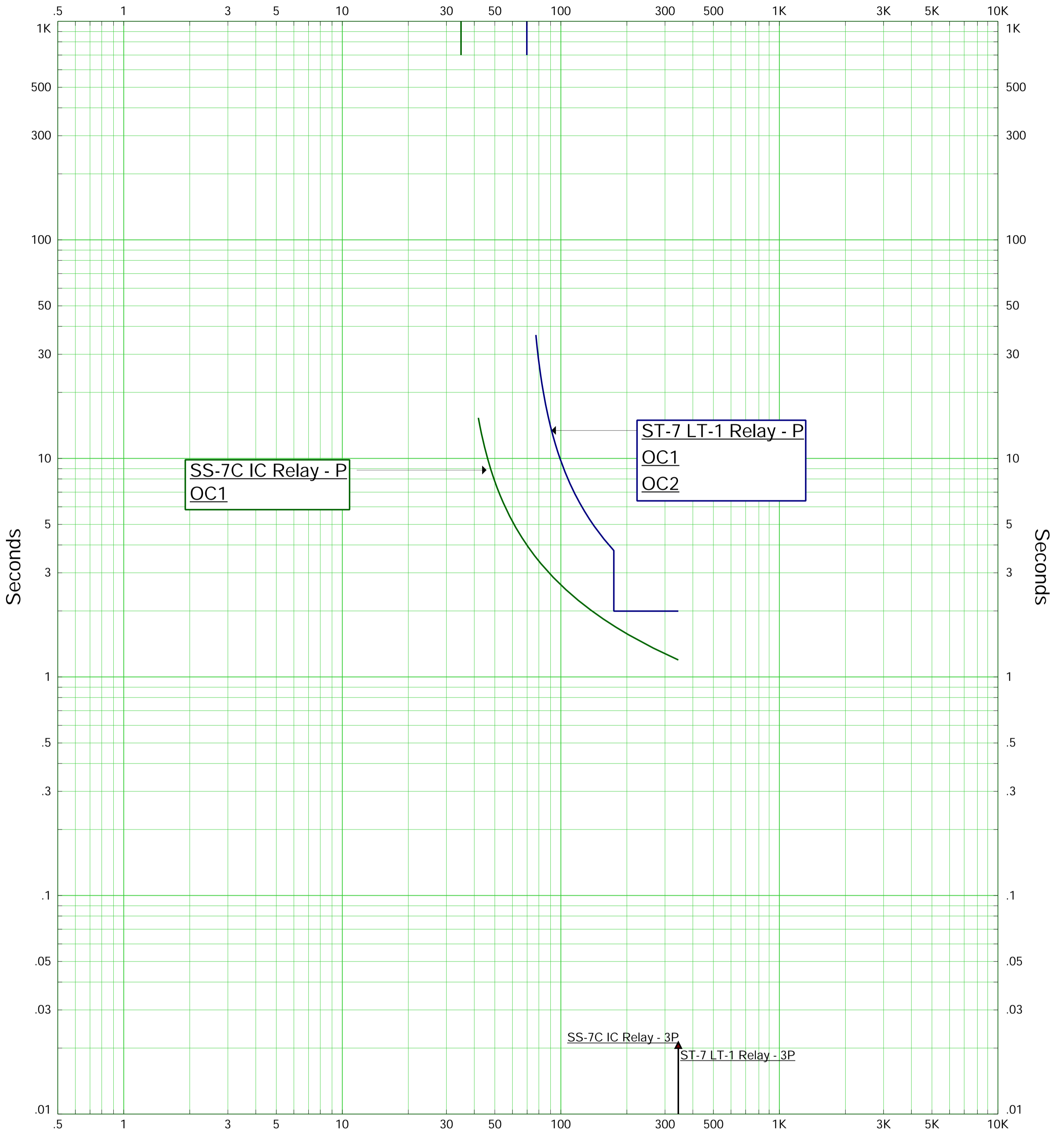

Amps X 100 SS-7C (Nom. kV=11, Plot Ref. kV=11.233)

ETAP Star 20.6.0C

SSCTPS	<b>ST-7 LT-1 TCC</b>	ERDA
		Rev: Base - RC1 Fault: Phase

Amps X 10 SS-7C (Nom. kV=11, Plot Ref. kV=11.233)

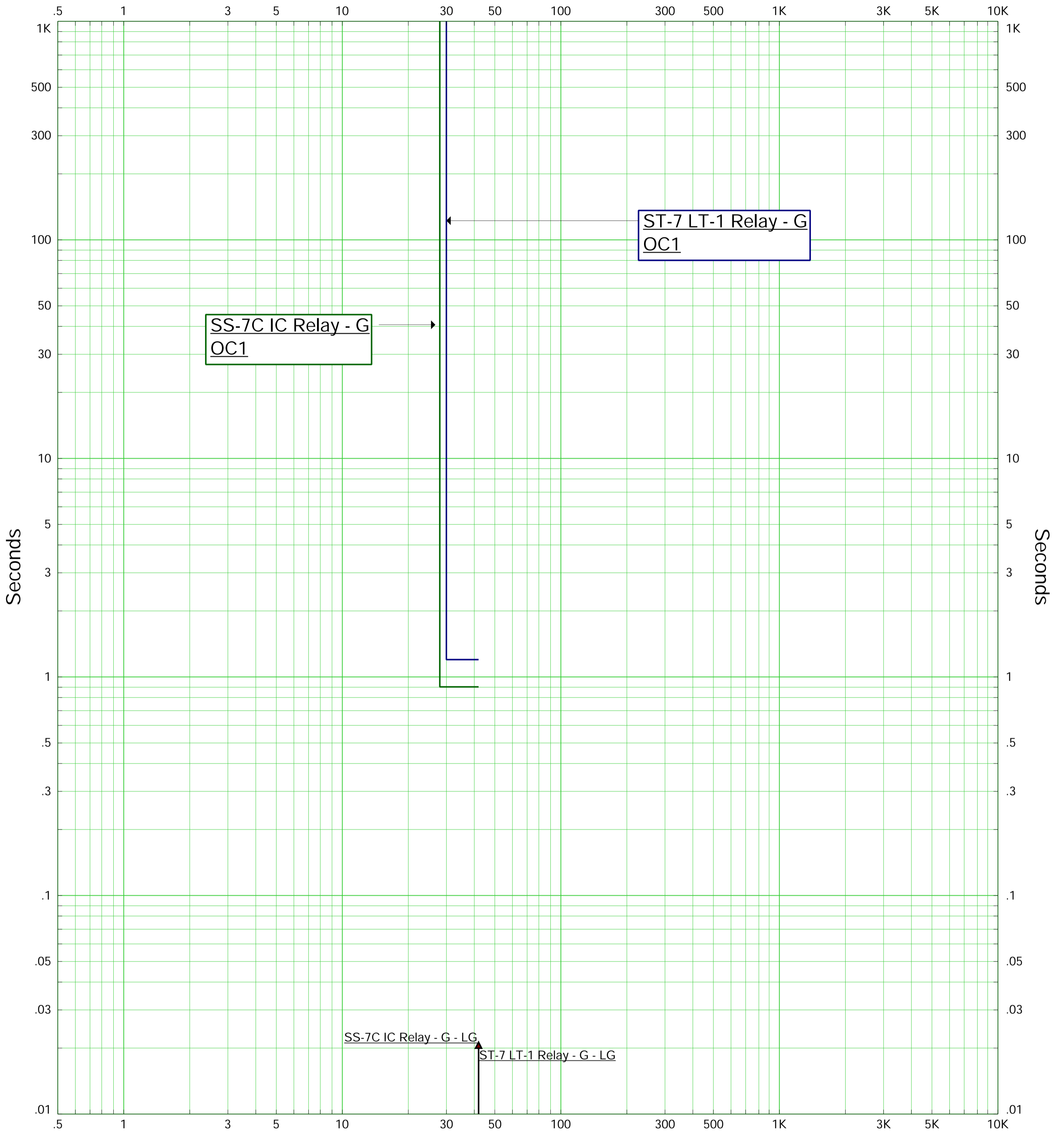

Amps X 10 SS-7C (Nom. kV=11, Plot Ref. kV=11.233)

ETAP Star 20.6.0C

SSCTPS	<b>ST-7 LT-1 TCC</b>	ERDA
		Rev: Base - RC1 Fault: Ground

Amps X 100 US-7A (Nom. kV=11, Plot Ref. kV=11.528)

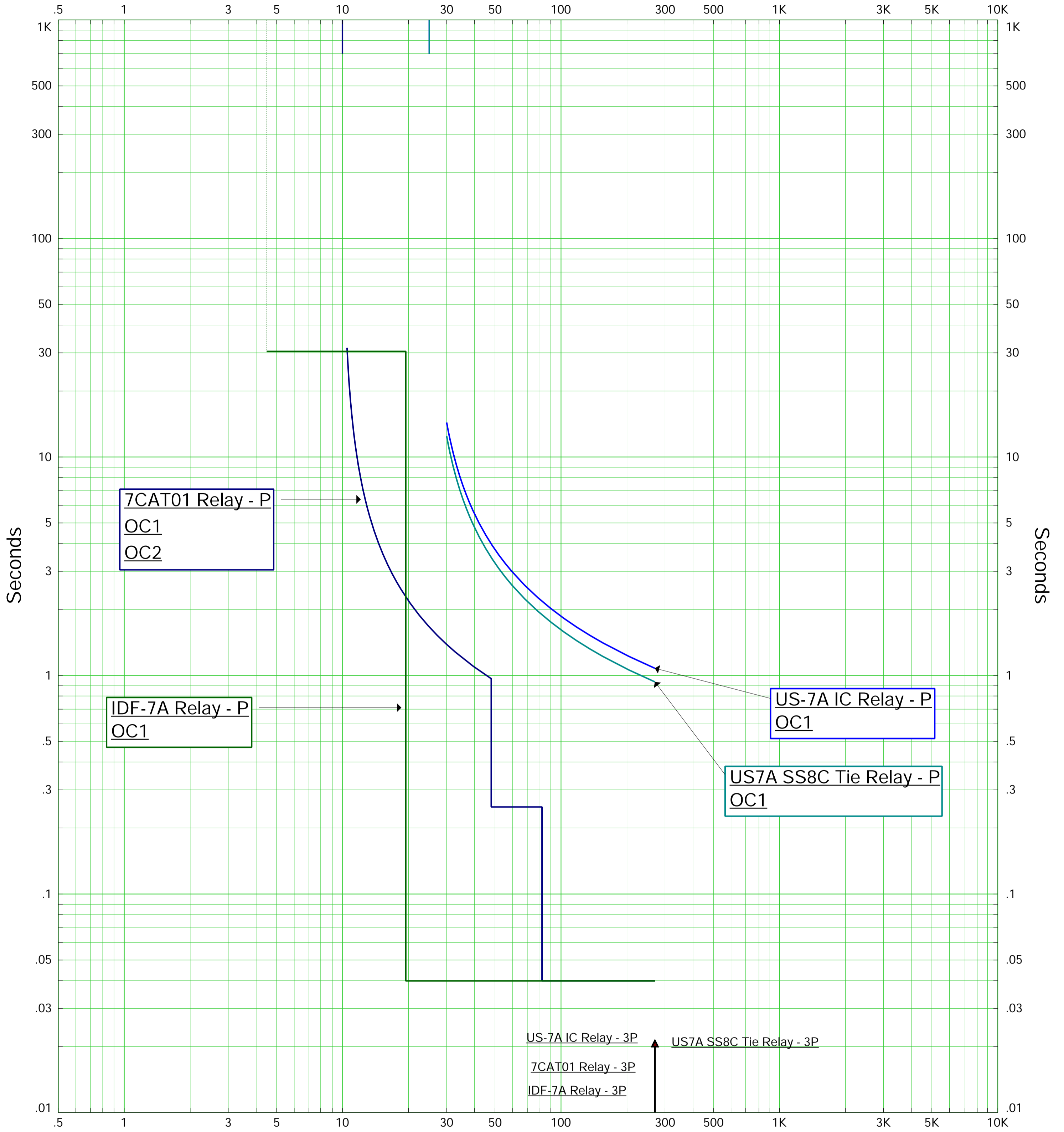

Amps X 100 US-7A (Nom. kV=11, Plot Ref. kV=11.528)

ETAP Star 20.6.0C

SSCTPS	<b>US-7A Bus TCC</b>	ERDA
		Rev: Base - RC1 Fault: Phase



Amps US-7A (Nom. kV=11, Plot Ref. kV=11.528)

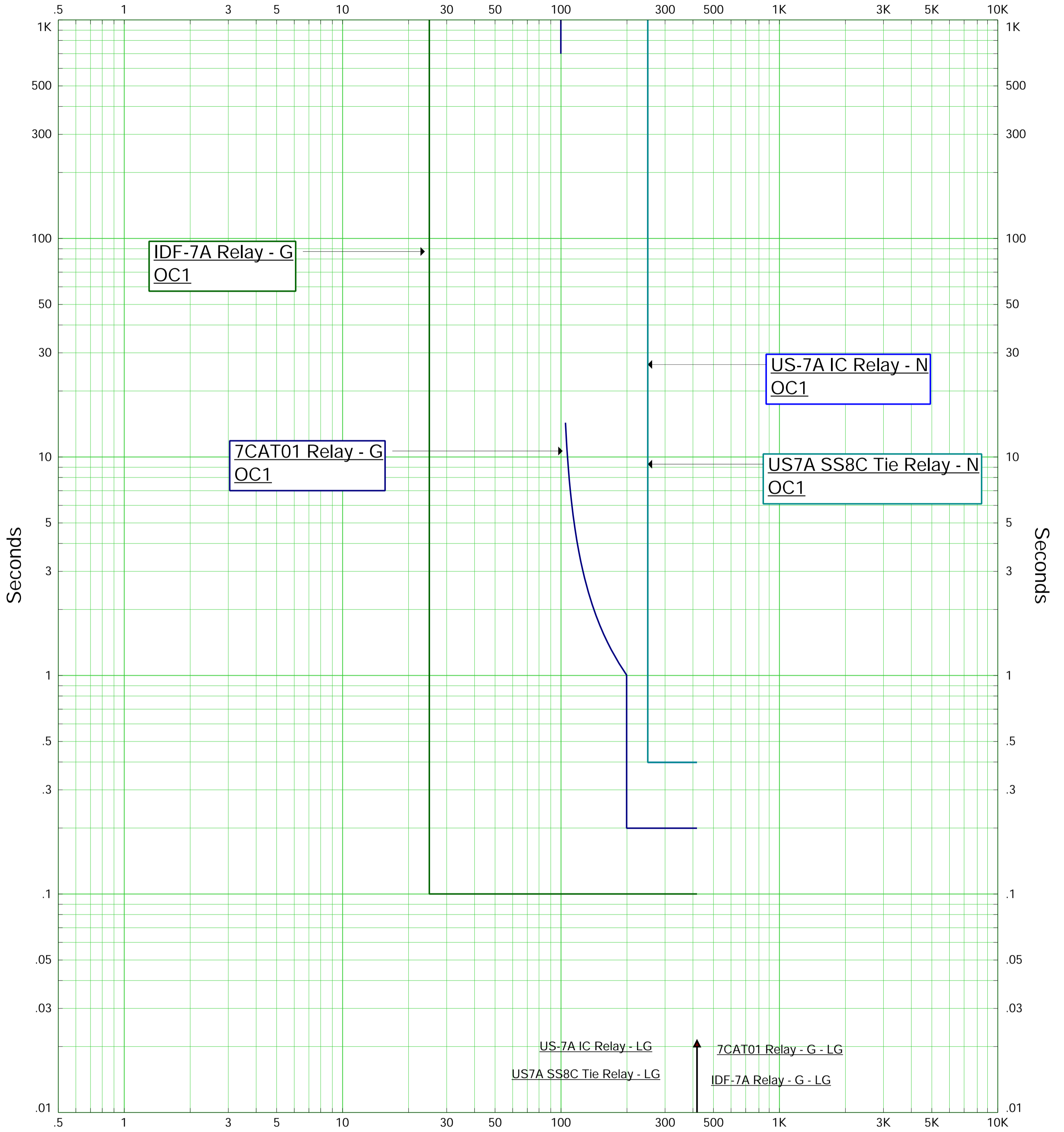

Amps US-7A (Nom. kV=11, Plot Ref. kV=11.528)

ETAP Star 20.6.0C

SSCTPS	<b>US-7A Bus TCC</b>	ERDA
		Rev: Base - RC1 Fault: Ground

Amps X 100 US-7B (Nom. kV=11, Plot Ref. kV=11.528)

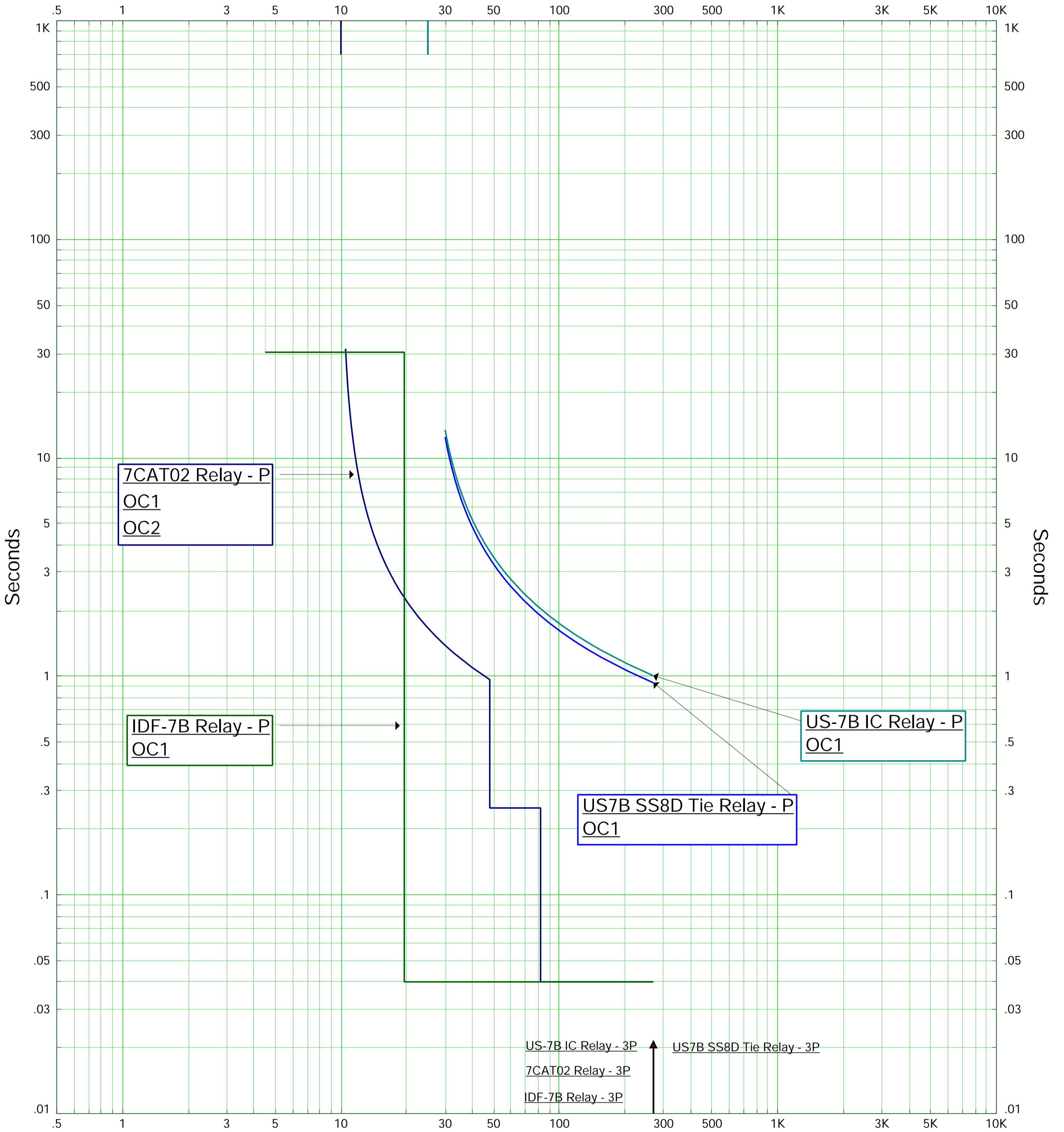

Amps X 100 US-7B (Nom. kV=11, Plot Ref. kV=11.528)

ETAP Star 20.6.0C

SSCTPS	<b>US-7B Bus TCC</b>	ERDA
		Rev: Base - RC1 Fault: Phase

Amps US-7B (Nom. kV=11, Plot Ref. kV=11.528)

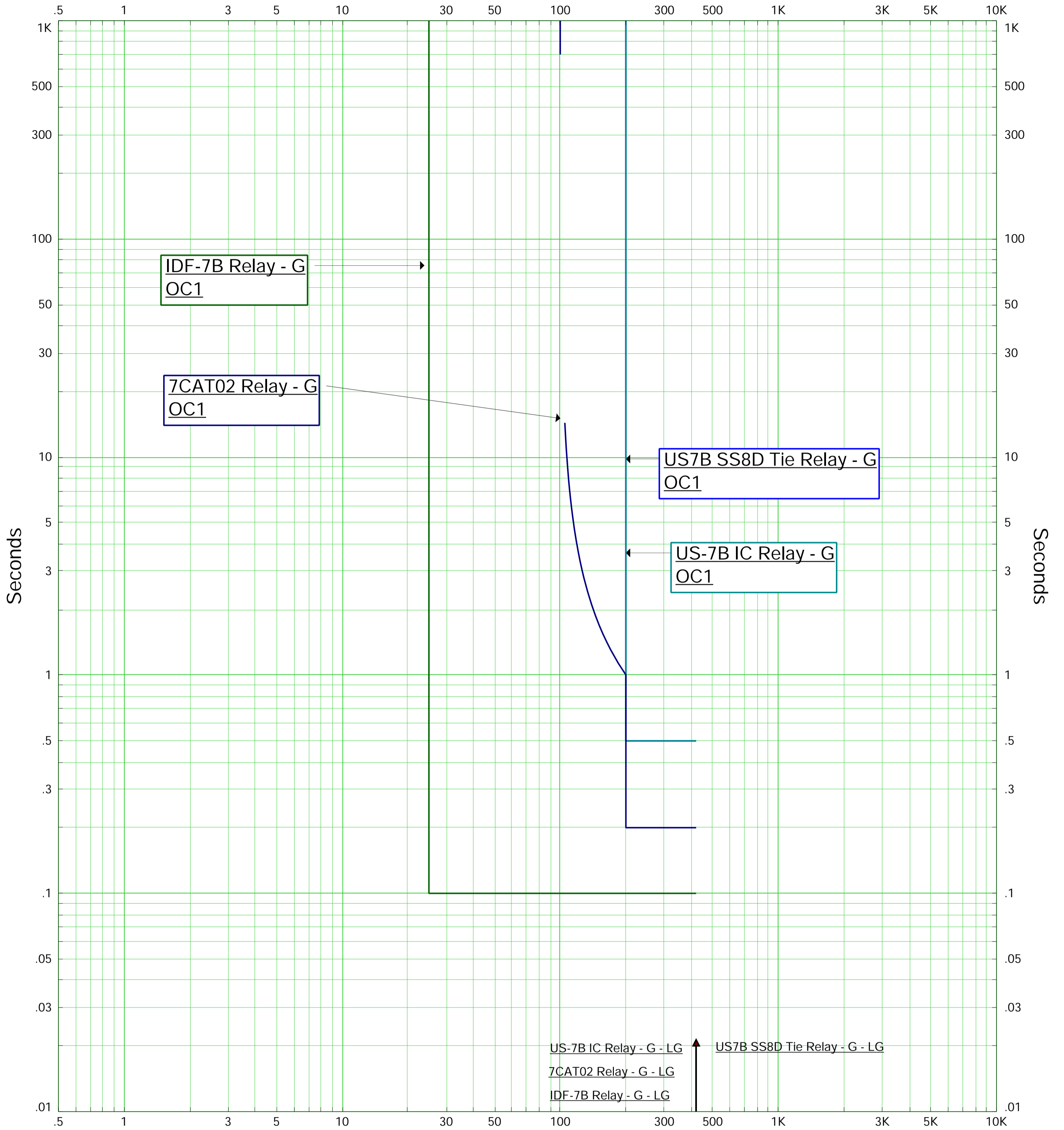

Amps US-7B (Nom. kV=11, Plot Ref. kV=11.528)

ETAP Star 20.6.0C

SSCTPS	<b>US-7B Bus TCC</b>	ERDA
		Rev: Base - RC1 Fault: Ground

Amps X 100 US-8A (Nom. kV=11, Plot Ref. kV=11.528)

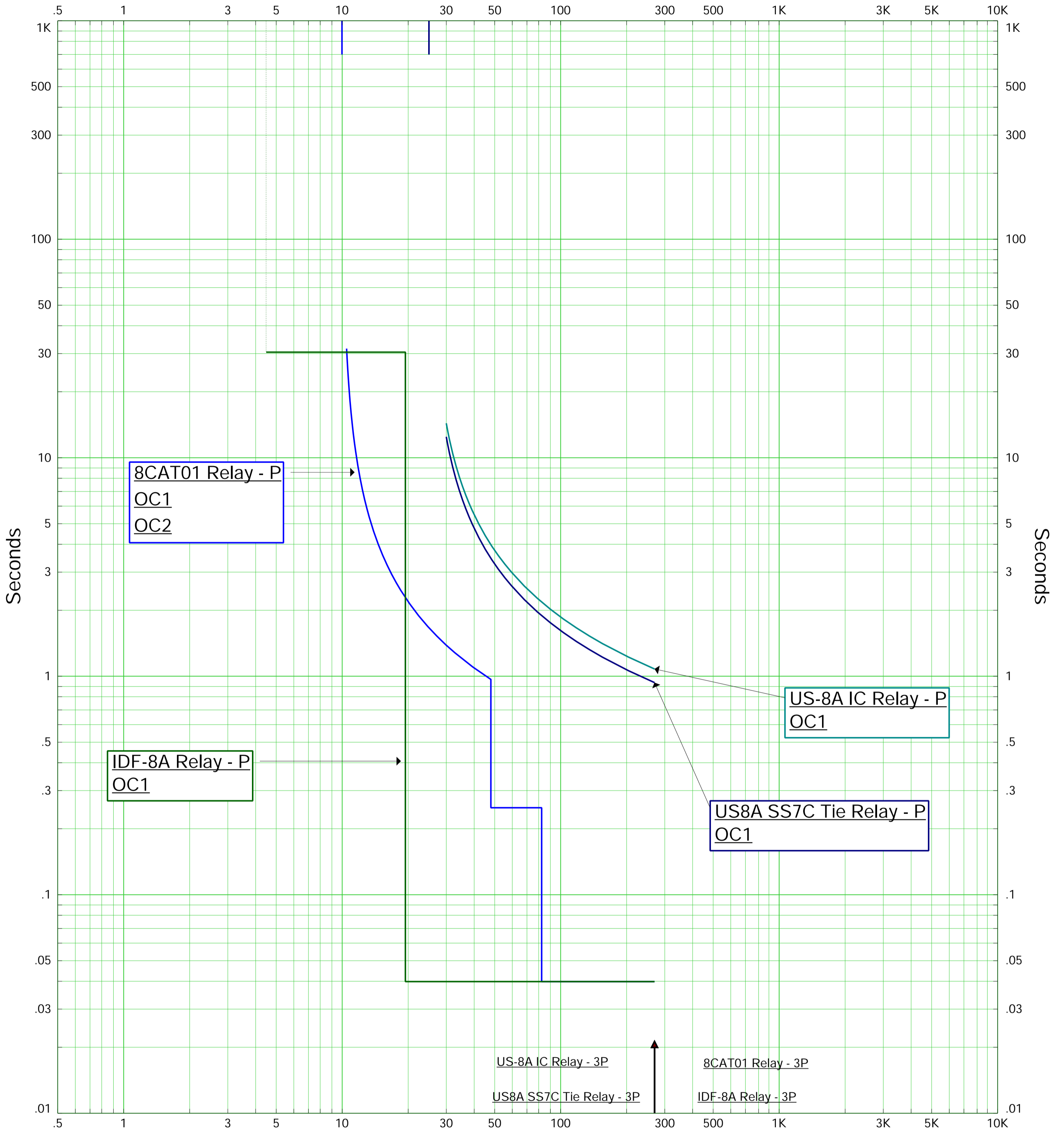

Amps X 100 US-8A (Nom. kV=11, Plot Ref. kV=11.528)

ETAP Star 20.6.0C

SSCTPS	<b>US-8A Bus TCC</b>	ERDA
Rev: Base - RC1 Fault: Phase		

Amps US-8A (Nom. kV=11, Plot Ref. kV=11.528)

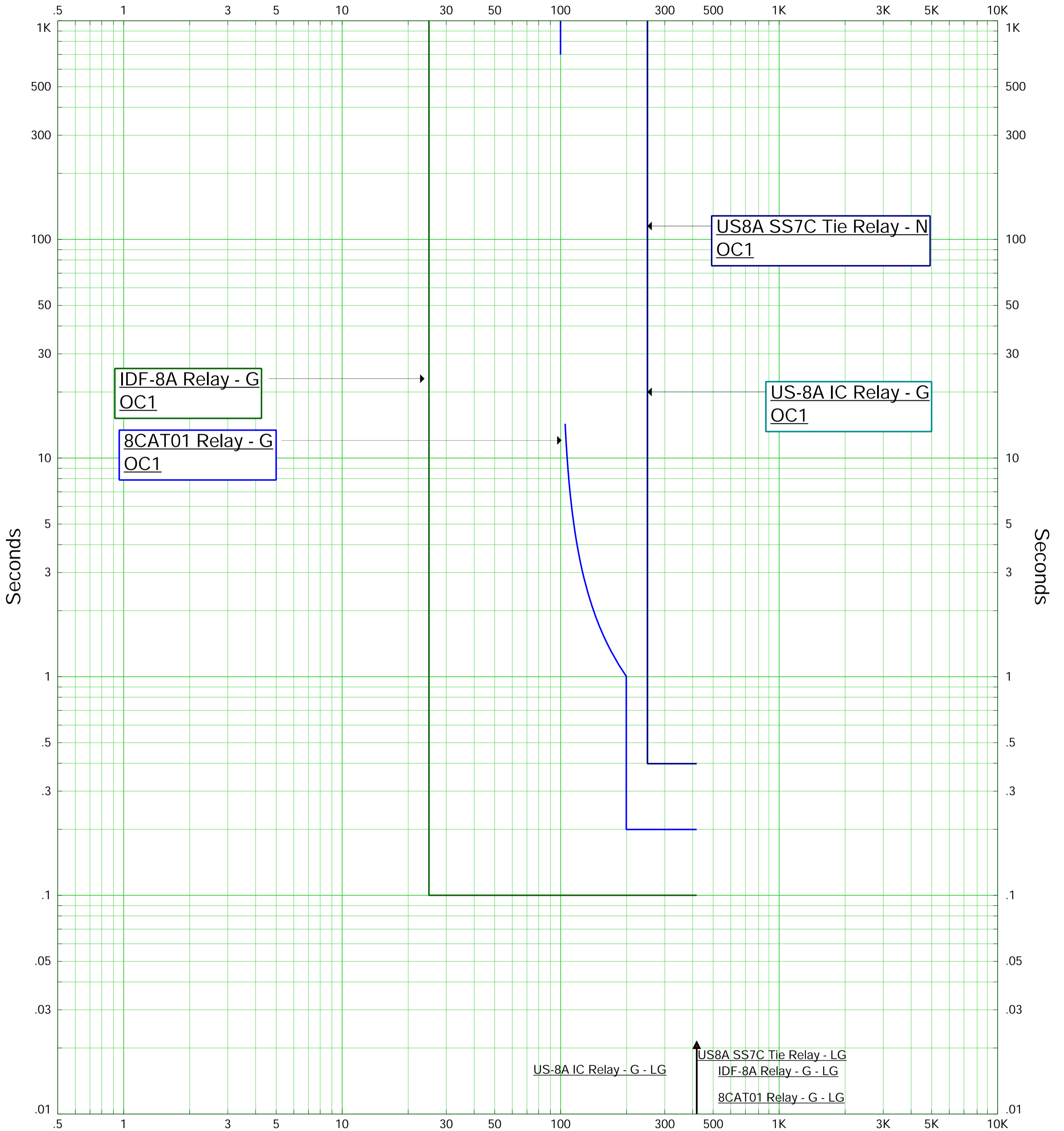

Amps US-8A (Nom. kV=11, Plot Ref. kV=11.528)

ETAP Star 20.6.0C

SSCTPS	<b>US-8A Bus TCC</b>	ERDA
Rev: Base - RC1 Fault: Ground		

Amps X 100 US-8B (Nom. kV=11, Plot Ref. kV=11.528)

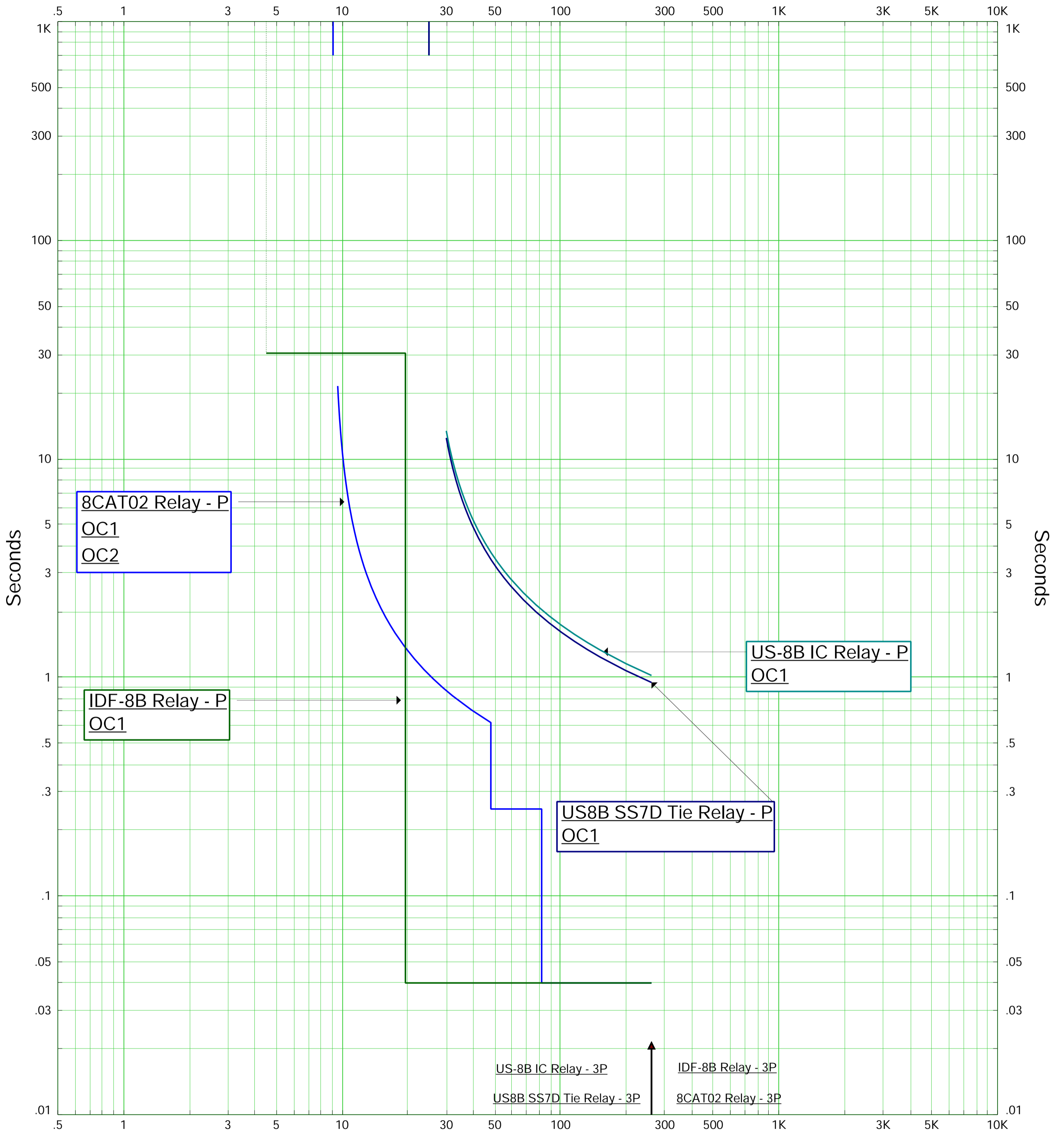

Amps X 100 US-8B (Nom. kV=11, Plot Ref. kV=11.528)

ETAP Star 20.6.0C



Amps US-8B (Nom. kV=11, Plot Ref. kV=11.528)

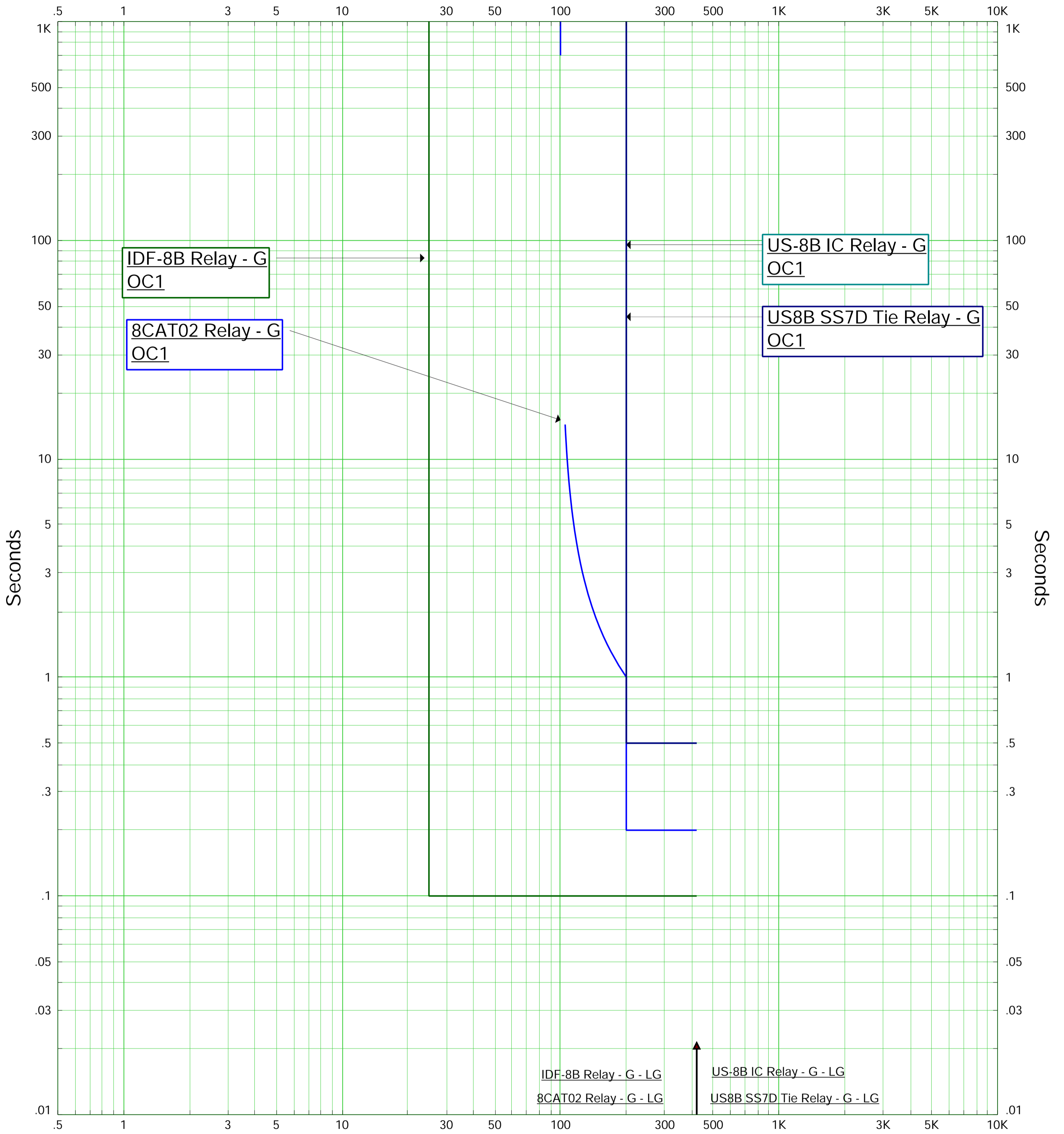

Amps US-8B (Nom. kV=11, Plot Ref. kV=11.528)

ETAP Star 20.6.0C

SSCTPS	<b>US-8B Bus TCC</b>	ERDA
		Rev: Base - RC1 Fault: Ground

Amps X 100 SS-7C (Nom. kV=11, Plot Ref. kV=11.233)

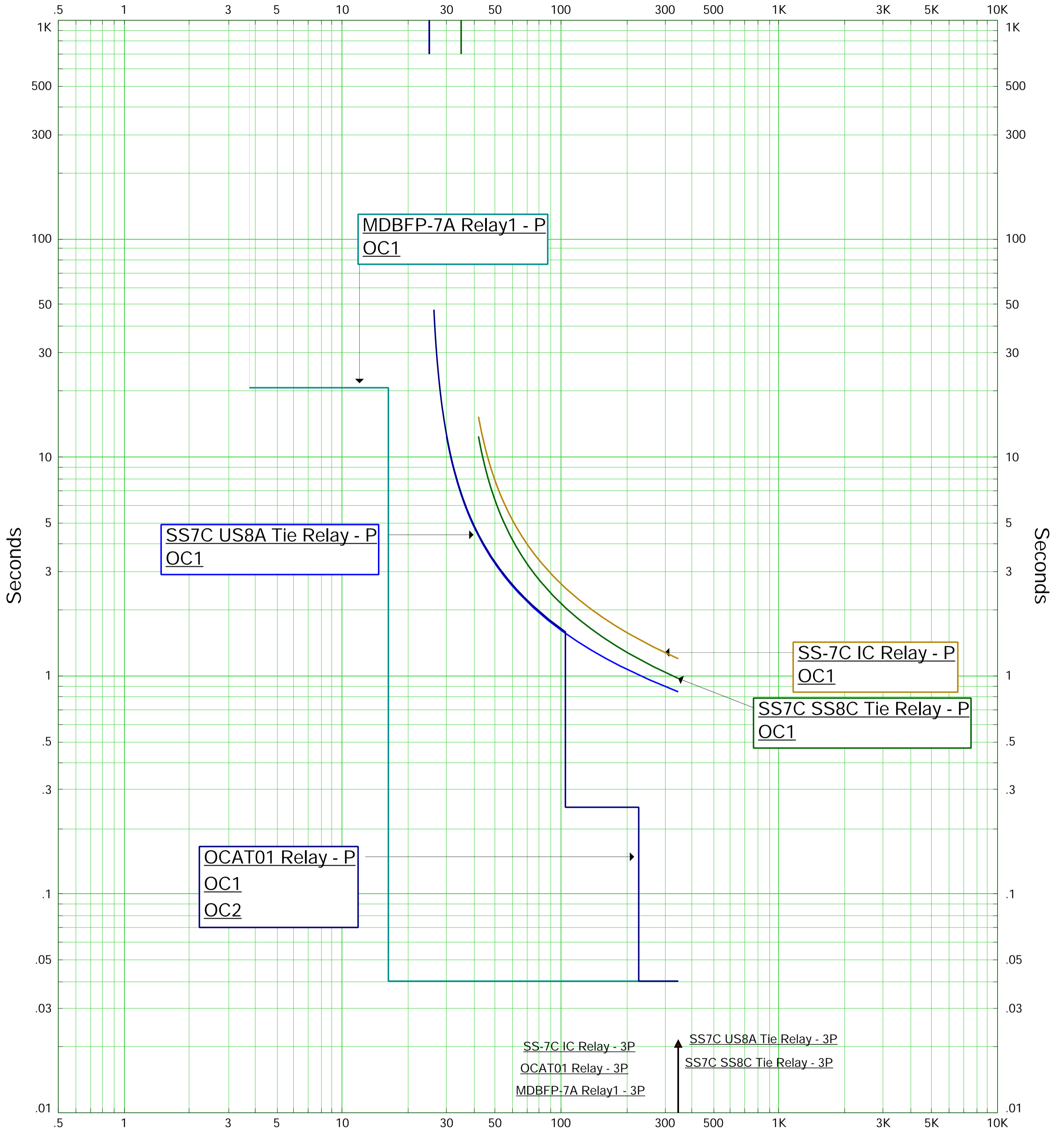

Amps X 100 SS-7C (Nom. kV=11, Plot Ref. kV=11.233)

ETAP Star 20.6.0C

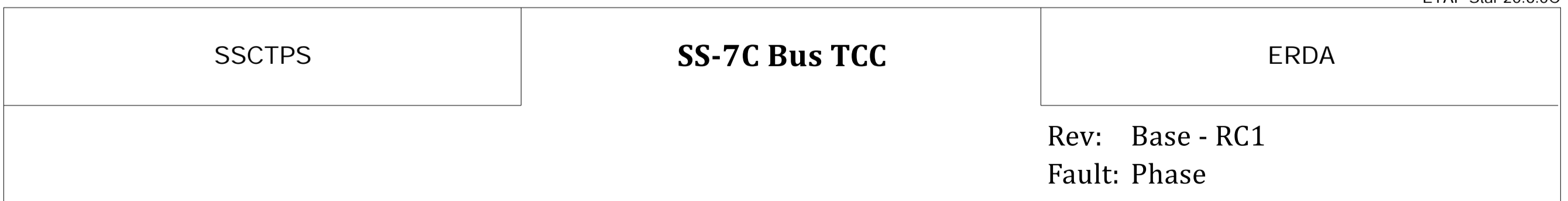



Amps SS-7C (Nom. kV=11, Plot Ref. kV=11.233)

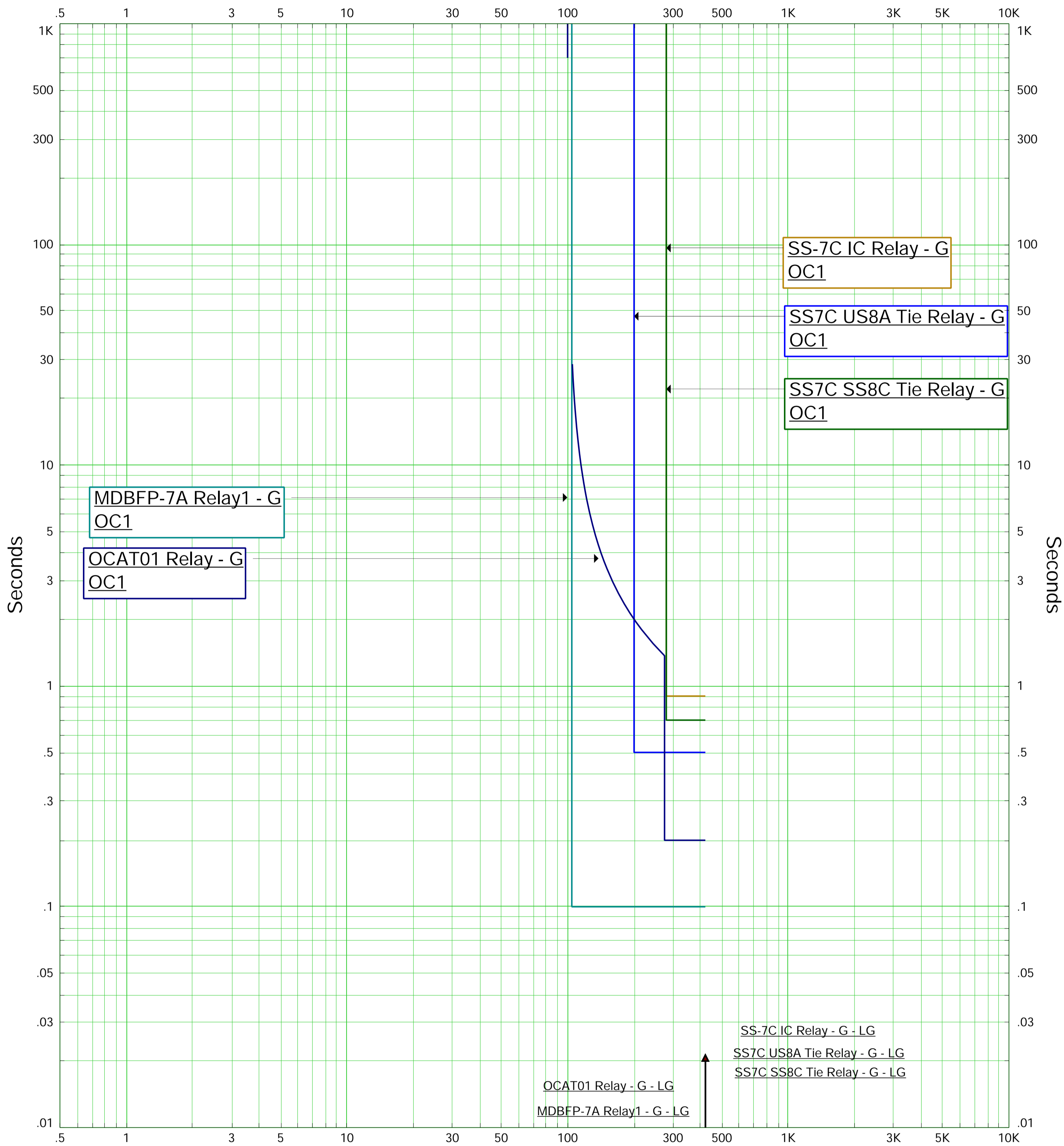

Amps SS-7C (Nom. kV=11, Plot Ref. kV=11.233)

ETAP Star 20.6.0C

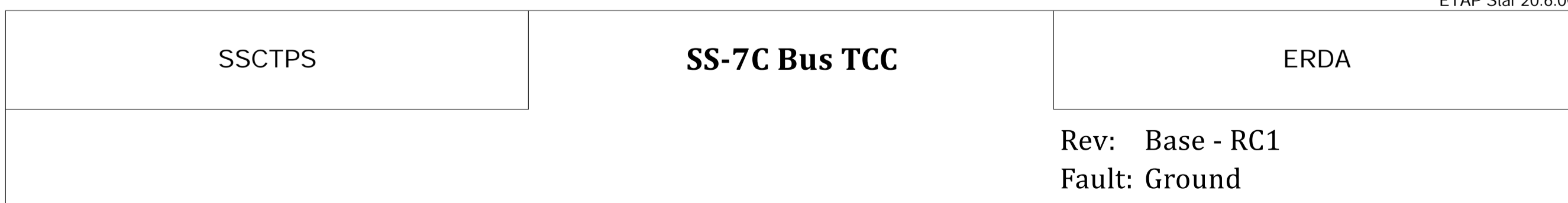

Amps X 100 SS-7D (Nom. kV=11, Plot Ref. kV=11.233)

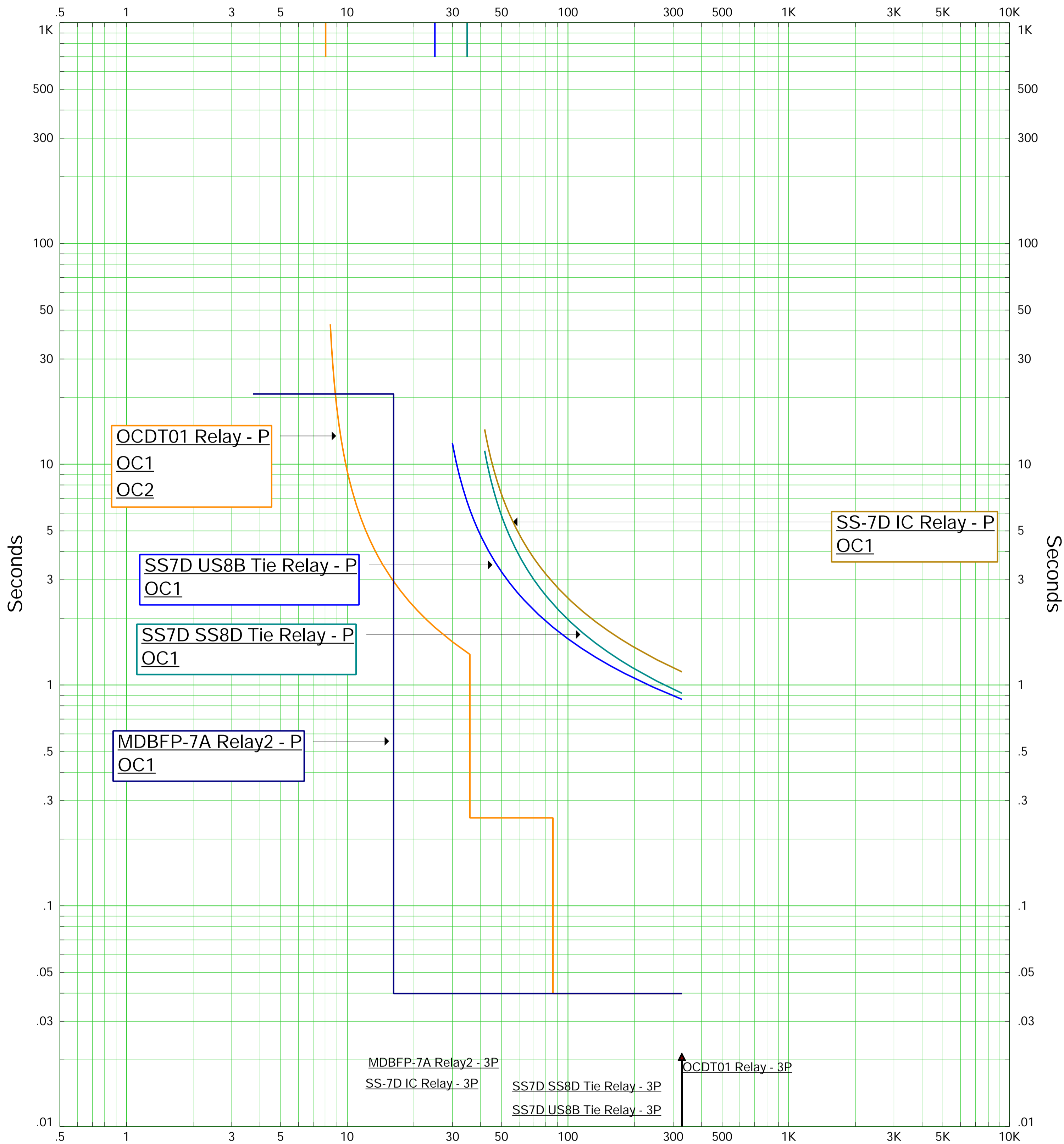

Amps X 100 SS-7D (Nom. kV=11, Plot Ref. kV=11.233)

ETAP Star 20.6.0C

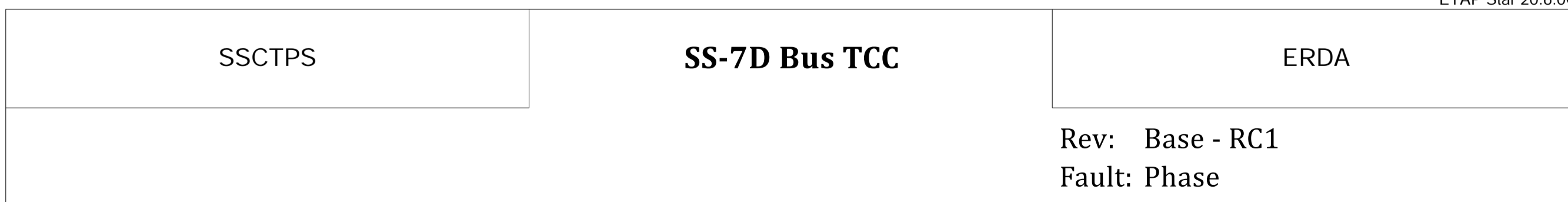

Amps SS-7D (Nom. kV=11, Plot Ref. kV=11.233)

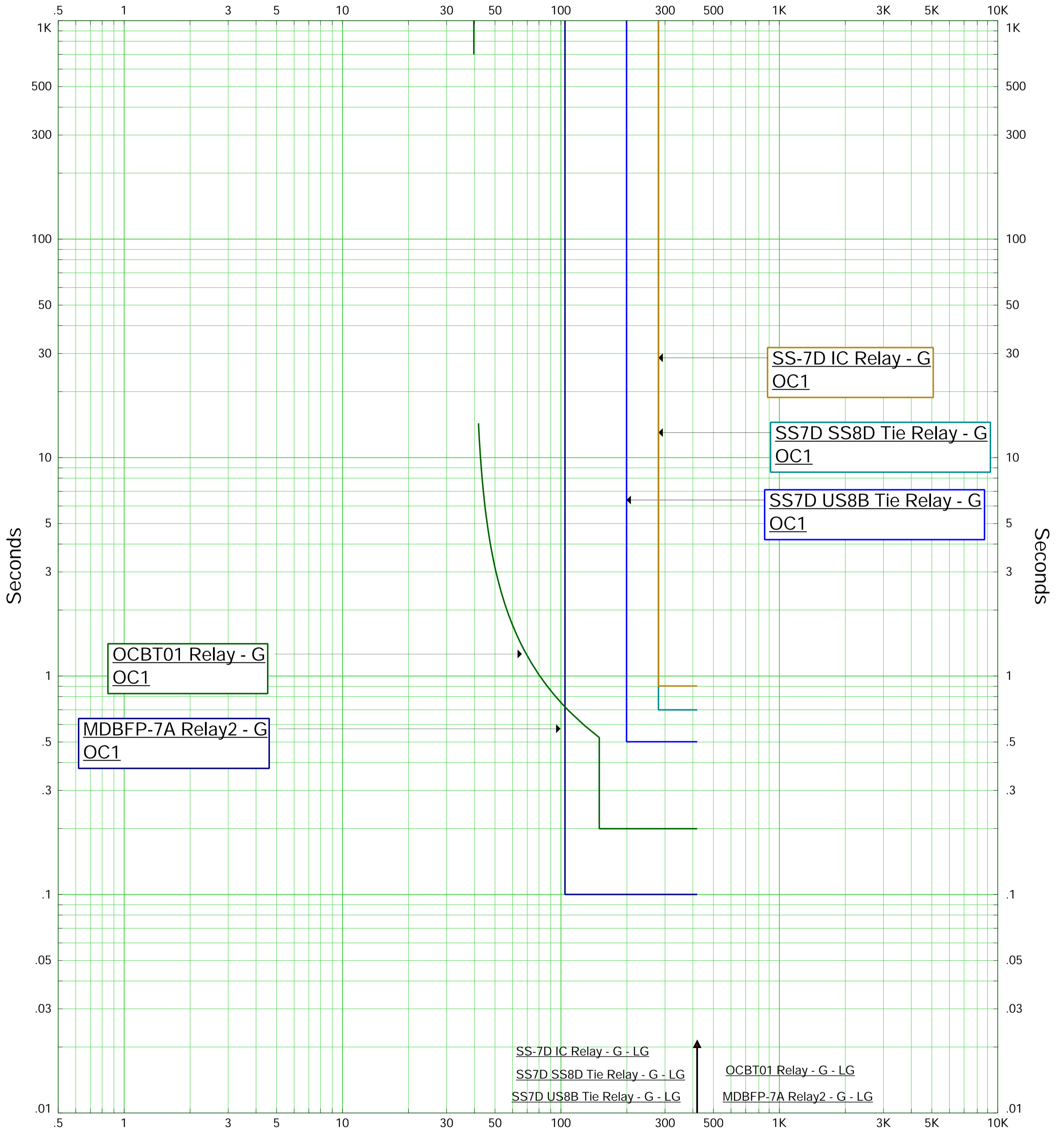

Amps SS-7D (Nom. kV=11, Plot Ref. kV=11.233)

ETAP Star 20.6.0C

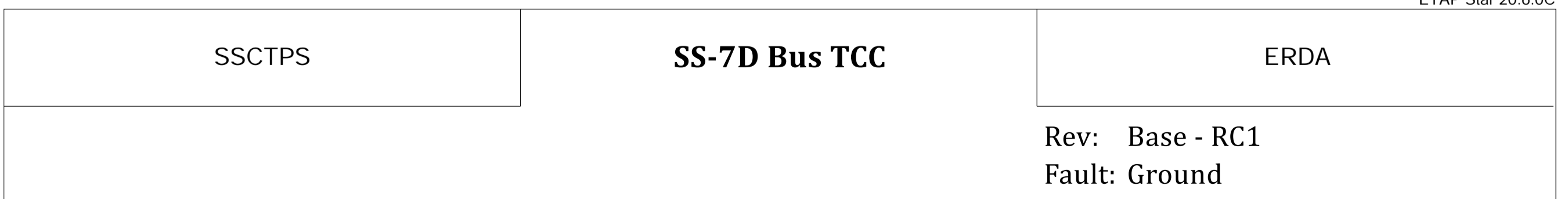

Amps X 100 SS-8C (Nom. kV=11, Plot Ref. kV=11.233)

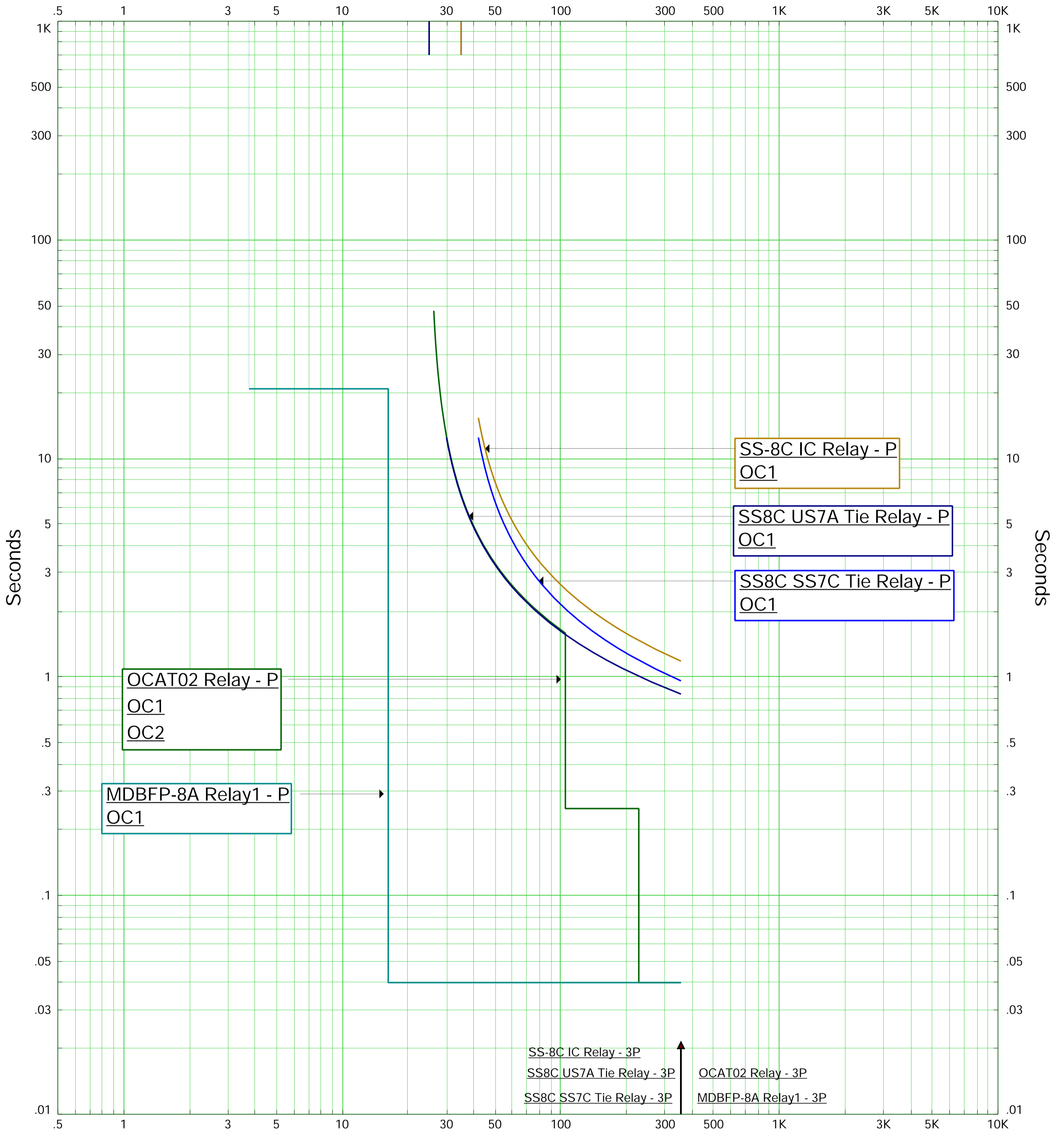

Amps X 100 SS-8C (Nom. kV=11, Plot Ref. kV=11.233)

ETAP Star 20.6.0C

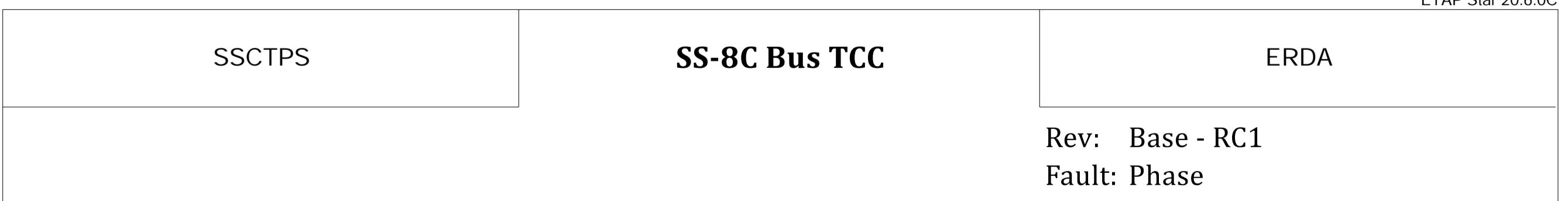

Amps SS-8C (Nom. kV=11, Plot Ref. kV=11.233)

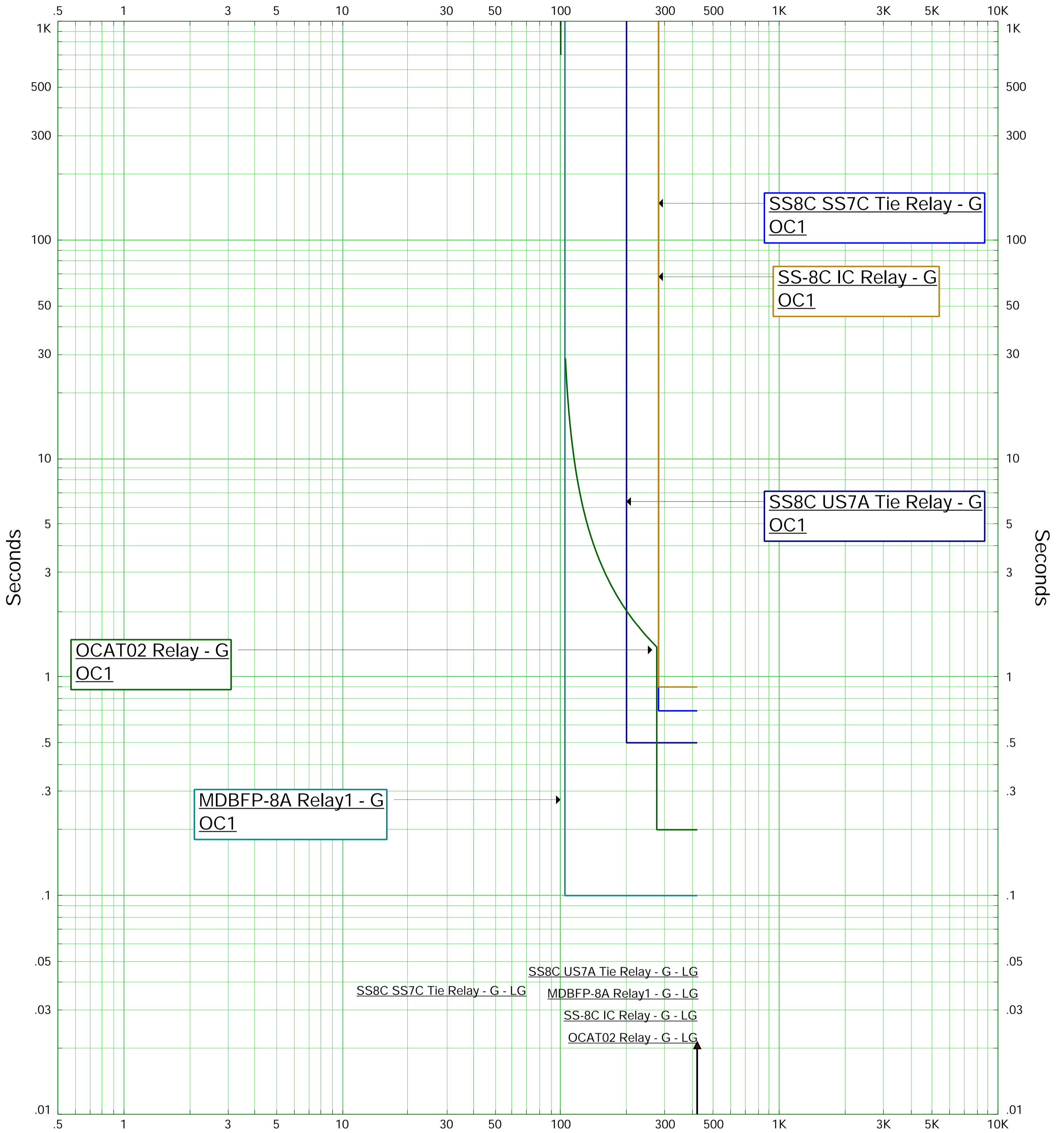

Amps SS-8C (Nom. kV=11, Plot Ref. kV=11.233)

ETAP Star 20.6.0C

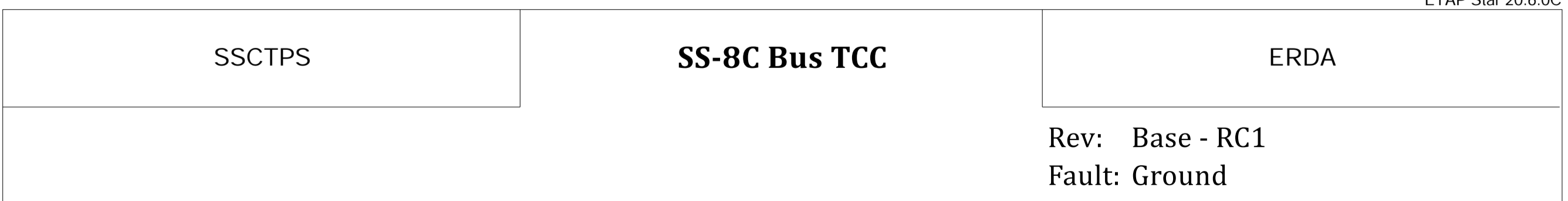

Amps X 100 SS-8D (Nom. kV=11, Plot Ref. kV=11.233)

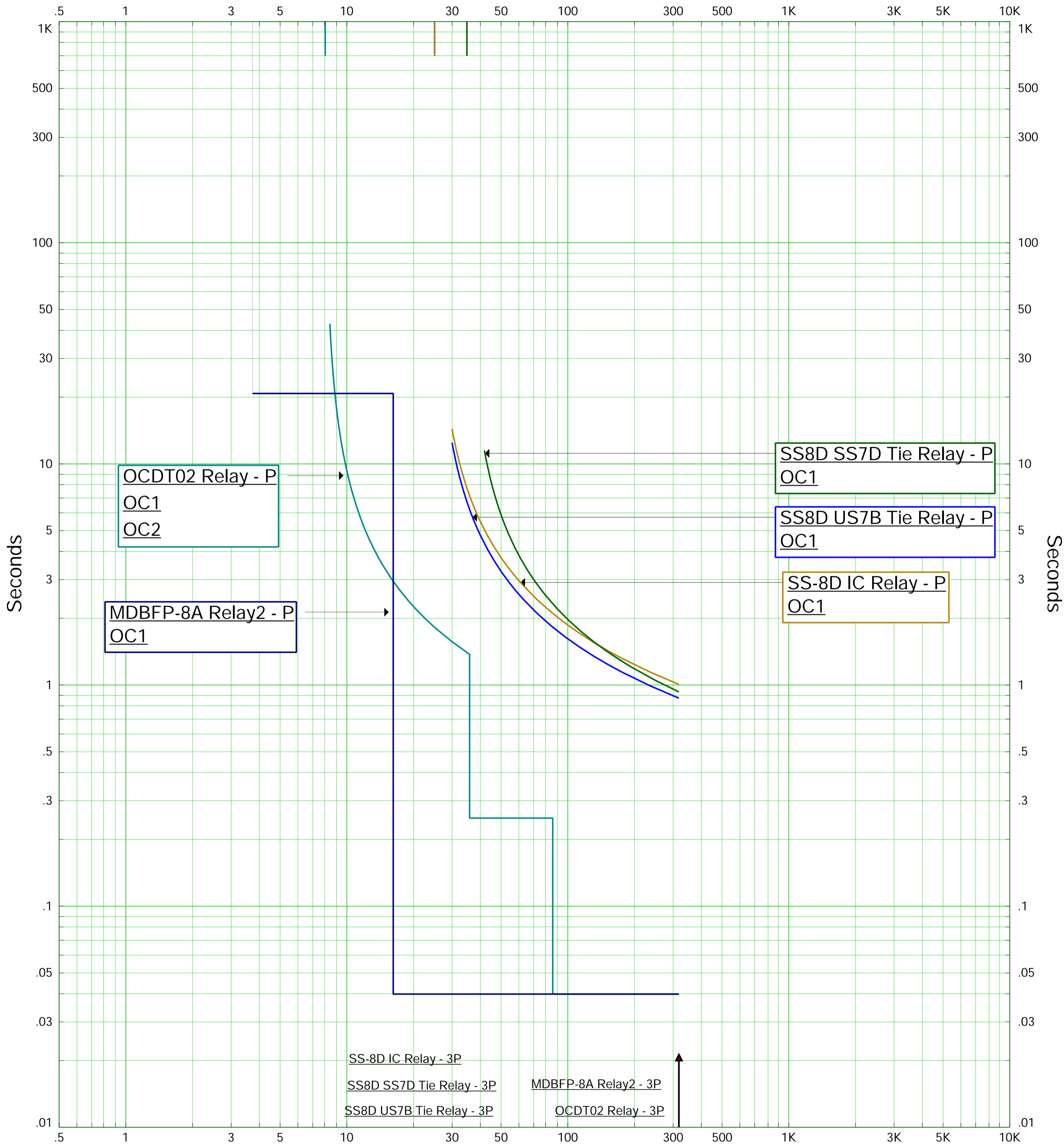

Amps X 100 SS-8D (Nom. kV=11, Plot Ref. kV=11.233)

ETAP Star 20.6.0C

SSCTPS	<b>SS-8D Bus TCC</b>	ERDA
		Rev: Base - RC1 Fault: Phase

Amps SS-8D (Nom. kV=11, Plot Ref. kV=11.233)

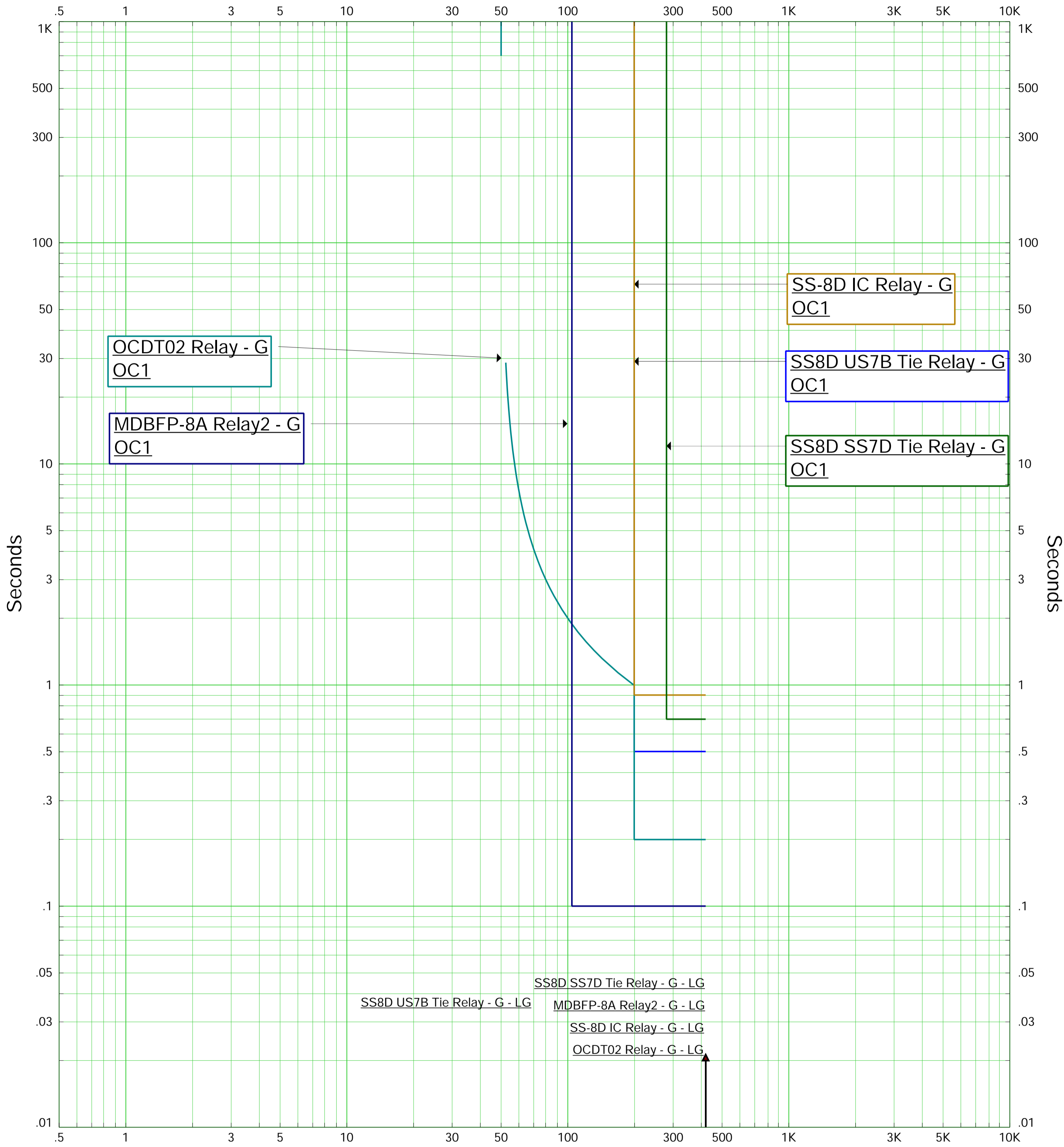

Amps SS-8D (Nom. kV=11, Plot Ref. kV=11.233)

ETAP Star 20.6.0C

SSCTPS	<b>SS-8D Bus TCC</b>	ERDA
		Rev: Base - RC1 Fault: Ground

# 9

## Review of various protection schemes

### 9.1 Review Distance Relay Settings

#### 9.1.1 400 kV Bikaner Line 1 & 2 Feeders Settings Review Details – Main-I Relay – Siemens 7SA522

Configuration	Adopted Settings	Recommended Settings	Remarks
Protected Line Length	142 kms.		
Adjacent Shortest Line Name & Length	400kV Bikaner to Deedwana (D/C) –129 kms.		
Adjacent Longest Line Name & Length	400kV Bikaner to Sikar (S/C) – 172 kms.		
R1	0.0288		
X1	0.30768		
R0	0.16192		
X0	1.24		
Fault MVA of Local Substation	21323		
Fault MVA of Remote End Substation	19494		
Voltage Rating (kV)	400kV		
Rating of Transformers (MVA)	315		
% Impedance	12.93		
CT Ratio	3000/1		
PT Ratio	400kV/110V		
CTR/PTR	0.825		
kZ1 Res Comp	1.02		
kZ1 Angle (Degree)	-3.16		
Z1	28.96 Ohm	28.84 Ohm	As per NRPC 80% of the Protected line
R(Z1) Resistance Ph-Ph	25.40 Ohm	32.86 Ohm	
R(Z1) Resistance Ph-E	33.87 Ohm	43.82 Ohm	
Zone 1 time	0 Sec	0 Sec	Setting is adequate



Configuration	Adopted Settings	Recommended Settings	Remarks
Z2	43.44 Ohm	53.71 Ohm	100% of the Protected line + 50% of the shortest line emanating from the far end bus bar or 120% of the Protected line whichever is higher
R(Z2) Resistance Ph-Ph	25.40 Ohm	41.08 Ohm	
R(Z2) Resistance Ph-E	33.87 Ohm	54.77 Ohm	
Zone 2 time	0.4 Sec	0.5 Sec	Time Setting: 350ms for short lines ( $\leq 100\text{km}$ ) and 500ms for long lines $> 100\text{km}$ .
Z3	80.05 Ohm	86.91 Ohm	120% of the protected line + 100% of the longest line emanating from the far end bus bar or 100% of the Protected line + 100% of the longest line emanating from the far end bus bar + 25% of the longest line emanating from the far end of the second line considered, whichever is lower
R(Z3) Resistance Ph-Ph	25.40 Ohm	51.35 Ohm	
R(Z3) Resistance Ph-E	33.87 Ohm	68.46 Ohm	
Zone 3 time	1.2 Sec	1 sec	Setting is adequate
Z4	7.24 Ohm	7.21 Ohm	25% of the Zone-1 reach. Time setting: 1000 ms
Zone 4 time	1.2Sec	1 Sec	
<b>Power Swing Blocking</b>			
Power Swing Unblocking Timer	2 Sec	2 Sec	Setting is adequate
<b>Auto Reclosing</b>			
Dead Time after 1 pole trip	1 Sec	1 sec	Setting is adequate
Dead Time after 3 pole trip	0.6 Sec	0.6 Sec	Setting is adequate
Reclaim time	25 Sec	25 Sec	Setting is adequate
<b>Overvoltage Protection</b>			
Alarm - 1 Sec	105% i. e. 115.5 V	115 V	Settings is adequate
Stage-I trip - 5 Sec	110% i. e. 121 V	121 V	Settings are adequate (Time delay for Stage-1 set to 5 sec & for Stage-II 0.1 sec)
Stage-II trip - 0msec	130% i. e. 154 V	154 V	

## 9.1.2 400 kV Bikaner Line 1 & 2 Feeders Settings Review Details – Main-II

### Relay Micom P442

400kV Bikaner D/c line - Line-I and II		
Parameter	Main II (Micom P442)	
	Existing settings	Reviewed settings
Line length (km)	142	142
Line Impedance (Ohm)	0.0288	0.0288
Line Angle (deg)	85	84.65
CT/PT Ratio	0.825	0.825
<b>Zone - 1 setting</b>		
kZ1 Res Comp	1.02	1.02
kZ1 Angle (Degree)	-3.16	-2.8
Z1 (Ohm)	28.96	28.96
R1G (Ohm)	33.87	43.65
R1Ph (Ohm)	25.40	33.38
tZ1 (sec)	0	0
<b>Zone - 2 setting</b>		
kZ2 Res Comp	1.016	1.02
kZ2 Angle (Degree)	-3.16	-2.8
Z2 (Ohm)	43.44	53.94
R2G (Ohm)	33.87	54.77
R2Ph (Ohm)	25.40	41.08
tZ2 (sec)	0.4	<b>0.5</b> <b>(As per NRPC Guideline)</b>
<b>Zone - 3 setting</b>		
kZ3/4 Res Comp	1.02	1.02
kZ3/4 Angle (Degree)	-3.16	-2.8
Z3 (Ohm)	80.05	87.29
R3G- R4G (Ohm)	33.87	68.46
R3Ph- R4Ph (Ohm)	25.40	51.35
tZ3 (sec)	1	<b>1</b> <b>(As per NRPC Guideline)</b>
<b>Zone -4 setting</b>		
Z4 (Ohm)	7.24	7.24
tZ4 (sec)	1	<b>1</b> <b>(As per NRPC Guideline)</b>
<b>Power Swing Blocking</b>		
PSB R	27.94 Ohm	Both $\Delta R$ and $\Delta X$ band settings are typically set between 10 – 30% of Zone-3 phase resistive reach It should be calculated as i.e. 15.40 Ohm (30%*R3Ph)
PSB X	87.73 Ohm	
Power Swing Unblocking Timer	2 Sec	2 Sec
<b>Fault Protection</b>		
a) Over current starting		Setting is adequate

<b>400kV Bikaner D/c line - Line-I and II</b>		
<b>Parameter</b>	<b>Main II (Micom P442)</b>	
	<b>Existing settings</b>	<b>Reviewed settings</b>
1.2 x Max load current / CT ratio	1.2 Amp	
b) Under voltage starting		
80% of Vnom/1.732	50.81 V	Setting is adequate
<b>c) Under impedance starting</b>		
Xfw=1.3 to 2 x Zone 3 reach	103.68 Ohm	112.99 Ohm
Rfw PG = 1.3 to 2 x Zone 3 Res PG	44.03 Ohm	89 Ohm
Rfw PP = 1.3 to 2 x Zone 3 Res PP	33.03 Ohm	66.75 Ohm
<b>Auto Re-closing with dead time</b>		
<b>Auto Reclosing</b>		
Dead Time after 1 pole trip	1 Sec	1 sec
Dead Time after 3 pole trip	0.6 Sec	0.6 Sec
Reclaim time	25 Sec	25 Sec

<b>Bikaner Line 1 &amp; 2 Tie Siemens 7VK610</b>		
<b>Group 50BF Breaker Failure – Siemens 7VK610</b>		
<b>Function</b>	<b>Existing Setting</b>	<b>Recommendations</b>
50BF Pickup current threshold	0.10 A	Setting is adequate, As per CBIP protection guideline publication no. 328
Minimum TRIP Command Duration	0.10 sec	Setting is adequate
Maximum Close Command Duration	0.10 sec	
Dead Time for CB test auto-reclosure	0.10 sec	
Delay after 1pole start for local trip	0.2 Sec	
Delay after 3pole start for local trip	0.2 Sec	
Delay of 2nd element for busbar trip	0.2 Sec	

### 9.1.3 400 kV Babai Line 1 & 2 Feeders Settings Review Details – Main-I

#### Relay – Siemens 7SA522

Configuration	Adopted Settings	Recommended Settings	Remarks
Protected Line Length	245 kms.		
Adjacent Shortest Line Name & Length	400kV Babai to STPS New – 245 kms.		
Adjacent Longest Line Name & Length	400kV Babai to Neemrana (D/C) – 89 kms.		
R1 (protected line)	0.0146832		
X1 (protected line)	0.25312		
R0 (protected line)	0.24912		
X0 (protected line)	0.99936		
Fault MVA of Local Substation	18584		
Fault MVA of Remote End Substation	10928		
Voltage Rating (kV)	400kV		
Rating of Transformers (MVA)	315		
% Impedance	12.93		
CT Ratio	3000/1		
PT Ratio	400kV/110V		
CTR/PTR	0.825		
Z1	41 Ohm	40.93 Ohm	As per NRPC 80% of the Protected line
R(Z1) Resistance Ph-Ph	25.40 Ohm	32.86 Ohm	
R(Z1) Resistance Ph-E	33.87 Ohm	43.82 Ohm	
Zone 1 time	0 Sec	0 Sec	Setting is adequate
Z2	61.497 Ohm	62.46 Ohm	100% of the Protected line + 50% of the shortest line emanating from the far end bus bar or 120% of the Protected line whichever is higher
R(Z2) Resistance Ph-Ph	25.40 Ohm	41.08 Ohm	
R(Z2) Resistance Ph-E	33.87 Ohm	54.77 Ohm	
Zone 2 time	0.4 Sec	0.5 Sec	Time Setting: 350ms for short lines ( $\leq 100\text{km}$ ) and 500ms for long lines $> 100\text{km}$ .

Configuration	Adopted Settings	Recommended Settings	Remarks
Z3	102.496 Ohm	112.55 Ohm	120% of the protected line + 100% of the longest line emanating from the far end bus bar or 100% of the Protected line + 100% of the longest line emanating from the far end bus bar + 25% of the longest line emanating from the far end of the second line considered, whichever is lower
R(Z3) Resistance Ph-Ph	25.40 Ohm	51.35 Ohm	
R(Z3) Resistance Ph-E	33.87 Ohm	68.46 Ohm	
Zone 3 time	1 Sec	1 sec	Setting is adequate
Z4	10.25 Ohm	10.23 Ohm	25% of the Zone-1 reach. Time setting: 1000 ms
Zone 4 time	1 Sec	1 Sec	
<b>Power Swing</b>			
Power Swing Unblocking Timer	2 Sec	2 Sec	Setting is adequate
<b>Auto Reclosing</b>			
Dead Time after 1 pole trip	1 Sec	1 Sec	Setting is adequate
Dead Time after 3 pole trip	0.6 Sec	0.6 Sec	Setting is adequate
Reclaim time	25 Sec	25 Sec	Setting is adequate
<b>Broken Conductor Protection</b>			
I2 threshold	20%	20%	Setting is adequate
Time	30 Sec	3-5 sec	3-5 Sec for alarm (As per NRPC Protection Philosophy)
<b>Overvoltage Protection</b>			
Alarm - 1 Sec	105% i. e. 115.5 V	115 V	Settings is adequate
Stage-I trip - 5 Sec	110% i. e. 121 V	121 V	Settings are adequate (Time delay for Stage-1 set to 5 sec & for Stage-II 0.1 sec)
Stage-II trip - 0msec	130% i. e. 154 V	154 V	
<b>Fault Protection</b>			
a) Over current starting			Settings is adequate
1.2 x Max load current / CT ratio	1.2 Amp	1.2 Amp	
b) Under voltage starting			Setting is adequate
80% of Vnom/1.732	50.81 V	50.81 V	

<b>Configuration</b>	<b>Adopted Settings</b>	<b>Recommended Settings</b>	<b>Remarks</b>
Xfw=1.3 to 2 x Zone 3 reach	133.07 Ohm	112.99 Ohm	110% of maximum of all zone X1 settings
Rfw PG = 1.3 to 2 x Zone 3 Res PG	44.03 Ohm	89 Ohm	
Rfw PP = 1.3 to 2 x Zone 3 Res PP	33.03 Ohm	66.75 Ohm	

## 9.1.4 400 kV Babai Line 1 & 2 Feeders Settings Review Details – Main-II

### Relay Micom P442

400kV Bikaner D/c line - Line-I and II		
Parameter	Main II (Micom P442)	
	Existing settings	Reviewed settings
Line length (km)	245	245
Line Impedance (Ohm)	0.2496	0.0288
Line Angle (deg)	84.65	86.68
CT/PT Ratio	0.825	0.825
<b>Zone - 1 setting</b>		
kZ1 Res Comp	1	1.028
kZ1 Angle (Degree)	0	-14.128
Z1 (Ohm)	41	40.998
R1G (Ohm)	33.87	43.64
R1Ph (Ohm)	25.40	33.37
tZ1 (sec)	0	0
<b>Zone - 2 setting</b>		
kZ2 Res Comp	1	1.028
kZ2 Angle (Degree)	0	-14.128
Z2 (Ohm)	61.50	62.593
R2G (Ohm)	33.87	54.77
R2Ph (Ohm)	25.40	41.07
tZ2 (sec)	0.4	<b>0.5</b> <b>(As per NRPC Guideline)</b>
<b>Zone - 3 setting</b>		
kZ3/4 Res Comp	1	1.028
kZ3/4 Angle (Degree)	0	-14.128
Z3 (Ohm)	102.50	112.745
R3G- R4G (Ohm)	33.87	68.46
R3Ph- R4Ph (Ohm)	25.40	51.35
tZ3 (sec)	1	<b>1</b> <b>(As per NRPC Guideline)</b>
<b>Zone -4 setting</b>		
Z4 (Ohm)	10.25	25% of the Zone-1 reach i. e. 10.25. Time setting: 1000 ms
tZ4 (sec)	1	<b>1</b> <b>(As per NRPC Guideline)</b>
<b>Power Swing Blocking</b>		
PSB R	27.94 Ohm	Both ΔR and ΔX band settings are typically set between 10 – 30% of Zone-3 phase resistive reach. It should be calculated as i.e. 15.40 Ohm (30%*R3Ph)
PSB X	112.59 Ohm	
Power Swing Unblocking Timer	2 Sec	2 Sec
<b>Fault Protection</b>		
a) Over current starting		Setting is adequate

<b>400kV Bikaner D/c line - Line-I and II</b>		
<b>Parameter</b>	<b>Main II (Micom P442)</b>	
	<b>Existing settings</b>	<b>Reviewed settings</b>
1.2 x Max load current / CT ratio	1.2 Amp	
b) Under voltage starting		
80% of Vnom/1.732	50.81 V	Setting is adequate
c) Under impedance starting		
Xfw=1.3 to 2 x Zone 3 reach	133.07 Ohm	146.32 Ohm
Rfw PG = 1.3 to 2 x Zone 3 Res PG	44.03 Ohm	89 Ohm
Rfw PP = 1.3 to 2 x Zone 3 Res PP	33.03 Ohm	66.75 Ohm
<b>Auto Re-closing with dead time</b>		
<b>Auto Reclosing</b>		
Dead Time after 1 pole trip	1 Sec	1 sec
Dead Time after 3 pole trip	0.6 Sec	0.6 Sec
Reclaim time	25 Sec	25 Sec



## 9.2 Review of Generator Transformer Protection Relay settings

There are six nos. of 1-phase 275 MVA, 21 kV/420 kV Generating Transformers available for unit 7 and 8 in the SSCTPS Plant. Protection provided for GT and required as per CBIP 274 revised guideline are as below:

Protection Type	Available Status in SSCTPS Plant
Differential Protection (87 GT)	Protection Provided in Siprotec 7UT635 Relay
Restricted Earth Fault (87NT)	Protection Provided in Siprotec 7SJ8022 Relay
Differential (87OH) GT Overhang Protection	Protection Provided in Siprotec 7U613 Relay

Parameter	GT-7 and GT-8 2 X 21 kV/420 kV	
Capacity	825 MVA	
% Impedance	16.00%	
LV CT ratio	14000/5	
HV CT ratio	1250/1	
Name of relay	Siprotec 7U635	
<b>Differential Protection</b>		
Function	Existing Setting	Observation
Pickup Value of Differential Curr.	0.2 I/InO	Recommended 20% setting
T I-DIFF> Time Delay	0.00 sec	Setting is adequate
Pickup Value of High Set Trip	8 I/InO	Setting is adequate
T I-DIFF>> Time Delay	0.00 sec	Setting is adequate
<b>Restricted Earth Fault - Siprotec 7SJ8022</b>		
Pick up value I-ref >	0.1 I/InS	Setting is adequate, As per CBIP manual current setting should be 0.1 to 0.4 I/In
T I-ref Time delay	0 sec	
Slope of charac I-ref>	0	
T IE>> Time Delay	0.00 sec	

Name of relay	Siemens 7UT613	
<b>Differential (87OH) GT Overhang Protection</b>		
Function	Existing Setting	Observation
50-2 Pickup	0.10 I/Ins	Settings are adequate, as per CBIP manual operating current shall be 0.1-0.4 In  Setting is adequate
50-2 Time Delay	0 Sec	
50-1 Pickup	0 I/Ins	
50-1 Time Delay	1 Sec	
50/51 2nd harmonic in % of fundamental	10%	
50/51 Maximum Current for Inr. Rest.	8.6 I/Ins	

<b>Group 50BF Breaker Failure – Siemens 7VK610</b>		
<b>Function</b>	<b>Existing Setting</b>	<b>Observation</b>
50BF Pickup current threshold	0.05 A	It should be 0.1 Amp, As per CBIP protection guideline publication no. 328  Settings are adequate
Minimum TRIP Command Duration	0.10 sec	
Maximum Close Command Duration	0.10 sec	
Dead Time for CB test-autoreclosure	0.10 sec	
Delay after 1pole start for local trip	0.2 Sec	
Delay after 3pole start for local trip	0.2 Sec	
Delay of 2nd element for busbar trip	0.2 Sec	

### 9.3 Review of Unit Transformer Protection Relay settings

There are four nos. of 21 kV/11.5 kV Unit Transformer provided in the SSCTPS Plant for Auxiliary load. Protection provided for Unit Transformer and required as per CBIP 274 revised guideline are as below:

<b>Protection Type</b>	<b>Available Status in SSCTPS Plant</b>
Unit Transformer Differential Protection (87 UAT)	Protection Provided in Siemens 7UT633 Relay
Over Excitation Protection	Protection Provided in Siemens 7UT633 Relay
Restricted Earth Fault (64 UAT)	Disabled

The details of setting and observation are as below:

<b>Parameter</b>	<b>Unit Transformer 7A-7B &amp; 8A-8B 4 X 40 MVA 21 kV / 11.5 kV</b>	
Capacity	40 MVA	
% Impedance	12.00%	
LV CT ratio	2500/1	
HV CT ratio	1250/1	
<b>Differential Protection</b>		
Siemens 7UT633		
<b>Function</b>	<b>Existing Setting</b>	<b>Observation</b>
Pickup Value of Differential Curr.	0.20 I/InO	Settings are adequate
T I-DIFF> Time Delay	0 Sec	
Pickup Value of High set trip	10 I/InO	

I-DIFF>> Time Delay	0 Sec	
2nd Harmonic Content in I-DIFF	15%	
Time for Cross-blocking 2nd Harm.	3 cycle	
nth Harmonic content in I-DIFF	30%	Settings are adequate
Time for Cross-blocking n-th Harm	0 cycle	Settings are adequate
<b>Over excitation Protection</b>		
U/f > Pickup	1.10	Settings is adequate
U/f > Time Delay	10 Sec	Recommended 5 sec Time delay continuously adjustable between 0.1 to 6.0 seconds at values of v/f between 100% to 130% of rated value.
U/f >> Pickup	1.40	Settings is adequate
T U/f >> Time Delay	0 Sec	Settings is adequate

#### 9.4 Review of Station Transformer Protection Relay settings

There are two nos. of 21 kV/11.5 kV Station Transformer provided in the SSCTPS Plant for providing supply to station load. Protection provided for station transformer and required as per CBIP 274 revised guideline are as below:

Protection Type	Available Status in SSCTPS Plant
Unit Transformer Differential Protection (87 UAT)	Protection Provided in Siemens 7UT633 Relay
Over Excitation Protection	Protection Provided in Siemens 7UT633 Relay
Restricted Earth Fault (64 UAT)	Disabled

The details of setting and observation are as below:

Parameter	Station Transformer 7 & 8 2 X 125 MVA 21 kV / 11.5 kV	
Capacity	125 MVA	
% Impedance	24.00%	
LV CT ratio	4000/1	
HV CT ratio	3500/1	
<b>Differential Protection</b>		
	Siemens 7UT633	
<b>Function</b>	Existing Setting	Observation
Pickup Value of Differential Curr.	0.20 I/InO	Settings are adequate
T I-DIFF> Time Delay	0 Sec	
Pickup Value of High set trip	5 I/InO	

I-DIFF>> Time Delay	0 Sec	
2nd Harmonic Content in I-DIFF	15%	
Time for Cross-blocking 2nd Harm.	3 cycle	
nth Harmonic content in I-DIFF	30%	As per CBIP manual no. 328 for the 5th Harmonic restrain levels is 25% need to review the same
Time for Cross-blocking n-th Harm	0 cycle	Settings is adequate
<b>Over excitation Protection</b>		
U/f > Pickup	1.10	Settings is adequate
U/f > Time Delay	10 Sec	Recommended 5 sec Time delay continuously adjustable between 0.1 to 6.0 seconds at values of v/f between 100% to 130% of rated value.
U/f >> Pickup	1.40	Settings is adequate
T U/f >> Time Delay	0 sec	Settings is adequate

## 9.5 Review of Reactor Protection Relay settings

There are 2 nos. of 420 kV, 125 MVAR Bus Reactor in the SSCTPS Plant. Protection provided for Reactor and required as per CBIP 274 revised guideline are as below:

Protection Type	Available Status in SSCTPS Plant
Differential Protection	Protection Provided in Siemens 7UT633 Relay
Restricted Earth Fault Protection	Disabled
LBB Protection	Protection Provided in Siemens 7VK61 Relay

The details of setting and observation are as below:

Capacity	<b>BUS REACTOR 2 X 125 MVAR, 400 kV</b>	
<b>Differential Protection</b>		
Function	<b>Siemens 7UT633</b>	
	Existing Setting	Observation
Pickup value of Diff current	0.15 I/Ino	As per CBIP Publication no. 328 "operating current sensitivity of at least 10% of nominal current"
Pickup value of Highest trip	6 I/Ino	As per CBIP Publication no. 328 "It should be possible to choose a setting of high level unrestrained different function as low as 200% to 400% of rated reactor current"
Inrush 2nd harmonic content in I-Diff	10%	Settings are adequate
Time for cross blocking 2nd Har.	100 ms	

Inrush 5th harmonic content in I-Diff	20%	
Time for cross blocking nth Har.	100 ms	
<b>LBB Protection</b>		
Function	<b>Siemens 7VK61</b>	
	Existing Setting	Observation
50BF Pickup current threshold	0.05 A	As per CBIP guide line it should be 0.1 A is recommended for lines and transformer
Minimum TRIP Command Duration	0.10 Sec	Setting are adequate.
Maximum Close Command Duration	0.10 Sec	
Dead Time for CB test-autoreclosure	0.10 Sec	
Delay after 1pole start for local trip	0.20 Sec	
Delay after 3pole start for local trip	0.20 Sec	
Delay of 2nd element for busbar trip	0.20 Sec	

Bus Reactor Tie Siemens 7VK610		
<b>Group 50BF Breaker Failure – Siemens 7VK610</b>		
<b>Function</b>	Existing Setting	
50BF Pickup current threshold	0.1 A	Settings are adequate
Minimum TRIP Command Duration	0.10 sec	
Maximum Close Command Duration	0.10 sec	
Dead Time for CB test-autoreclosure	0.10 sec	
Delay after 1pole start for local trip	0.2 Sec	
Delay after 3pole start for local trip	0.2 Sec	
Delay of 2nd element for busbar trip	0.2 Sec	

Capacity	<b>Bikaner Line-1 &amp; 2 REACTOR 2 X 50 MVAR, 400 kV</b>	
<b>Differential Protection (Main-1 &amp; Main-2)</b>		
Function	<b>Siemens 7UT633</b>	
	Existing Setting	Observation
Pickup value of Diff current	0.15 I/Ino	As per CBIP Publication no. 328 "operating current sensitivity of at least 10% of nominal current
Pickup value of Highest trip	6 I/Ino	As per CBIP Publication no. 328 "It should be possible to choose a setting of high level unrestrained different function as low as 200% to 400% of rated reactor current"
Inrush 2nd harmonic content in I-Diff	10%	Settings are adequate
Time for cross blocking 2nd Har.	100 ms	
Inrush 5th harmonic content in I-Diff	20%	
Time for cross blocking nth Har.	100 ms	

<b>LBB Protection</b>		
Function	<b>Siemens 7VK61</b>	
	Existing Setting	Observation
50BF Pickup current threshold	0.10 A	Setting are adequate.
Minimum TRIP Command Duration	0.10 Sec	
Maximum Close Command Duration	0.10 Sec	
Dead Time for CB test-autoreclosure	0.10 Sec	
Delay after 1pole start for local trip	0.20 Sec	
Delay after 3pole start for local trip	0.20 Sec	
Delay of 2nd element for busbar trip	0.20 Sec	

Capacity	<b>Babai Line-1 &amp; 2 REACTOR 2 X 80 MVAR, 400 kV</b>	
<b>Differential Protection (Main-1 &amp; Main-2)</b>		
Function	<b>Siemens 7UT633</b>	
	Existing Setting	Observation
Pickup value of Diff current	0.12 I/Ino	As per CBIP Publication no. 328 "operating current sensitivity of at least 10% of nominal current

Pickup value of Highest trip	4.8 I/Ino	As per CBIP Publication no. 328 “It should be possible to choose a setting of high level unrestrained different function as low as 200% to 400% of rated reactor current”
Inrush 2nd harmonic content in I-Diff	10%	Settings are adequate
Time for cross blocking 2nd Har.	100 ms	
Inrush 5th harmonic content in I-Diff	20%	
Time for cross blocking nth Har.	100 ms	
<b>LBB Protection</b>		
Function	<b>Siemens 7VK61</b>	
	Existing Setting	Observation
50BF Pickup current threshold	0.10 A	Setting are adequate.
Minimum TRIP Command Duration	0.10 Sec	
Maximum Close Command Duration	0.10 Sec	
Dead Time for CB test-autoreclosure	0.10 Sec	
Delay after 1pole start for local trip	0.20 Sec	
Delay after 3pole start for local trip	0.20 Sec	
Delay of 2nd element for busbar trip	0.20 Sec	

## 9.6 Review of 400 kV Interconnector Relay settings

Function	Existing Setting	Observation
Rated Primary voltage		400 kV
Rated Secondary voltage		110 V
CTR		2000/1A
<b>Differential Protection</b>		
Settings	<b>Siemens 7SD5</b>	
I-DIFF>	0.1 A	Recommended 0.2 A
I-DIF>SWITCH ON	0.3 A	Setting is adequate as per relay manual
I-DIFF>>	1.2 A	

Function	Existing Setting	Observation
I-DIF>>>SWITCHON	1.5 A	
<b>Inst. High Speed/SOTF-O/C</b>		
I>>> Pickup	1.5 A	
I>>>> Pickup	$\infty$ A	
<b>Backup Overcurrent Protection</b>		
Iph>> Pickup	4.5 A	Setting is adequate as per relay manual
T Iph>> Time delay	0 sec	
3I0>> Pickup	0.1 A	
T 3I0>> Time delay	1.2 sec	
Iph> Pickup	1.5 A	
T Iph> Time delay	2 sec	
3I0> Pickup	0.1 A	
T 3I0> Time delay	1.2 sec	
<b>Backup Overcurrent Protection- Group Inverse</b>		
Ip> Pickup	0.5 A	Setting is adequate as per relay manual
T Ip Time Dial	0.10 sec	
3I0p Pickup	4 A	
T 3I0p Time Dial	$\infty$ sec	
<b>LBB Protection</b>		
<b>Siemens 7VK61</b>		
50BF Pickup current threshold	0.14 A	As per CBIP guide line it should be 0.1 A is recommended for lines and transformer
Minimum TRIP Command Duration	0.10 sec	Settings are adequate
Maximum Close Command Duration	0.10 sec	
Dead Time for CB test-autoreclosure	0.10 sec	
Delay after 1pole start for local trip	0.2 sec	
Delay after 3pole start for local trip	0.20 sec	
Delay of 2nd element for busbar trip	0.20 sec	



## Review of Bus Bar protection relay settings

# 10

There one and Half Breaker scheme arrangement in SSCTPS Plant of 400 kV. Protection provided for Bus Bar arrangement and required as per CBIP 274 revised guideline are as below:

Protection Type	Available Status in SSCTPS Plant
400 kV Bus Bar Protection	Protection Provided in Siemens 7SS85 Relay

The details of setting and observation are as below:

400 kV Bus Bar		
Particulars	Siemens 7SS85	
DIFF PROTECTION	Existing Settings	Observation
ID>1 Current	1.5 I/Ir obj	Settings are adequate
Stabilization Factor k:	0.65	

# 11

## Recommendations:

ERDA has conducted the comprehensive Protection Audit of 400kV switchyard & control room of Suratgarh Super Critical Thermal Power Station and found various recommendations in order to improve the reliability of power system and to avoid unwanted outages in the transmission of power at various levels.

### Some of the Observations / Recommendations, based on technical audit carried out by ERDA are:

- **Observation and Recommendation**

- 1. Line Protection**

The settings are reviewed and tabulated in the report.

- 2. Transformer Protection**

The settings are reviewed and tabulated in the report.

- 3. 220 kV Circuit Breaker Testing:**

All the tests as per IEC – 62271-100 (2017) should be performed for 400kV Circuit Breakers. The breakers should be tested at regular intervals. The tests to be conducted in the circuit breakers are contact resistance measurement, opening and closing time of all the 3 phases of the circuit breaker and check trip/closing circuit for delay operation etc. The interval for testing of breaker is around 3 to 5 years.

- 4. Transformer testing should be carried out at regular time intervals. Tan-delta test of transformer required to be carried out at regular intervals and necessary steps should be taken in case of testing results being unsatisfactory.**
- 5. Regular testing and maintenance should be carried out for CT and PT. The accuracy test shall be done in every 3 years while all other tests required to be carried out within 1 year time duration. All the aforesaid tests to be conducted as per relevant IS.**
- 6. Testing of relays should be carried out once every year to check its IR value, timing etc.**
- 7. Relay coordination study is carried out considering the existing capacity of Power Plant. Relay settings has been recommended in the report. ERDA team has provided the recommended settings of phase and ground by checking the proper coordination between upstream and downstream.**
- 8. For Zone-2 Distance protection as per NRPC guidelines, “100% of the Protected line + 50% of the shortest line emanating from the far end bus bar or 120% of the Protected line whichever is higher.” The existing setting is considered as whichever is less. ERDA has calculated the settings of Zone-2 based on the NRPC guideline and calculated settings is given in the report**

9. For Zone-3 Distance protection as per NRPC guidelines, “120% of the protected line + 100% of the longest line emanating from the far end bus bar or 100% of the Protected line + 100% of the longest line emanating from the far end bus bar + 25% of the longest line emanating from the far end of the second line considered, whichever is lower.” The existing setting is considered as 100% of the protected line + 100% of the longest line. ERDA has calculated the settings of Zone-3 with 120% of protected line + 100% of longest line and calculated settings is given in the report.
10. As per Ramkrishna committee report Main-1 and Main-2 relay should be connected to two DC source

# Annexure-I

# SINGLE LINE

# DIAGRAM

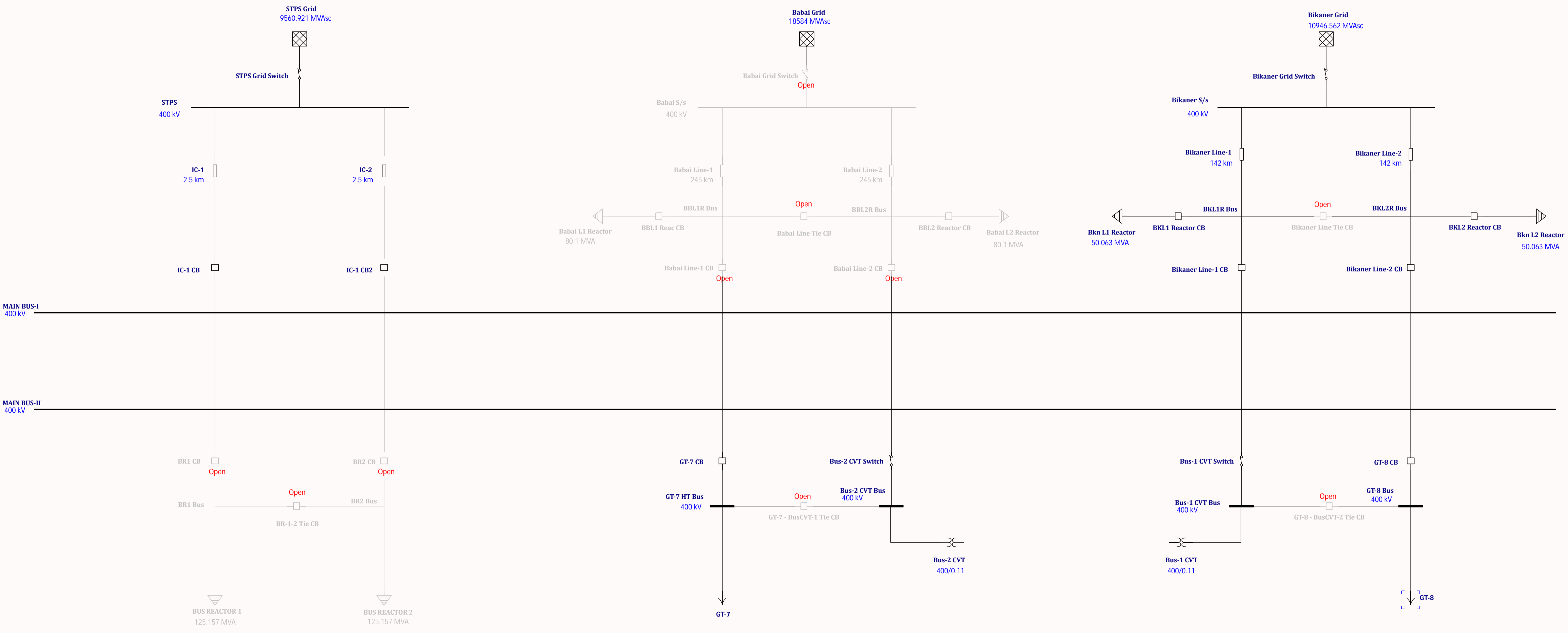

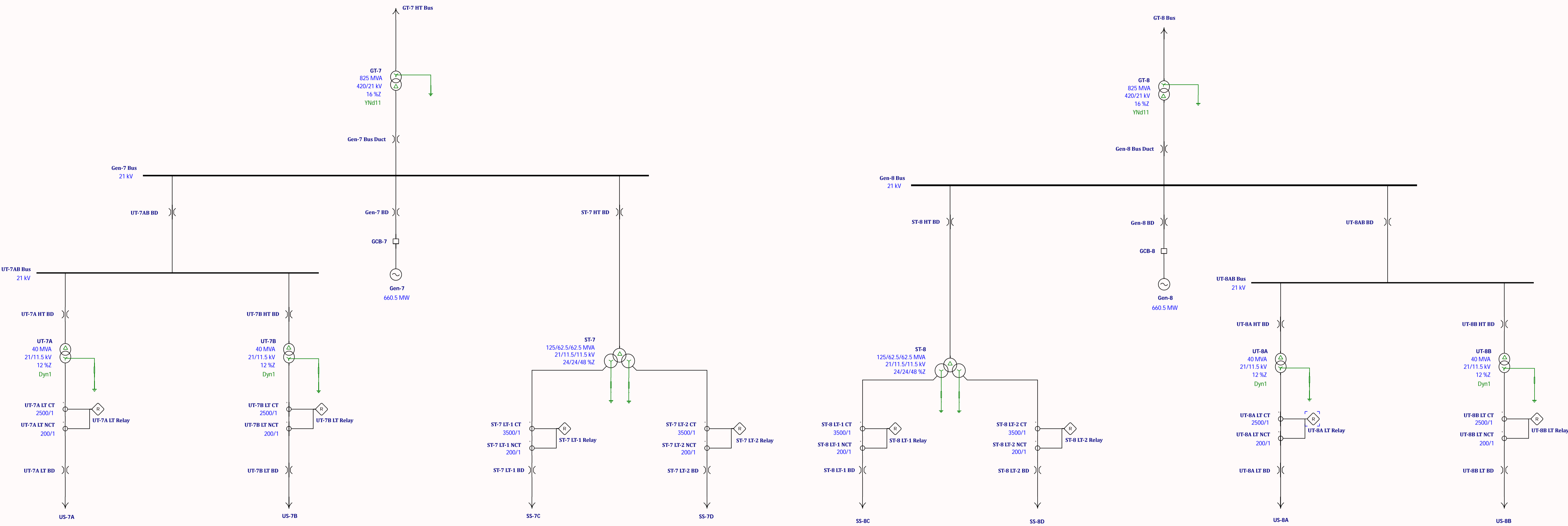

Unit SWBD  
7BB

Unit SWBD  
7BB

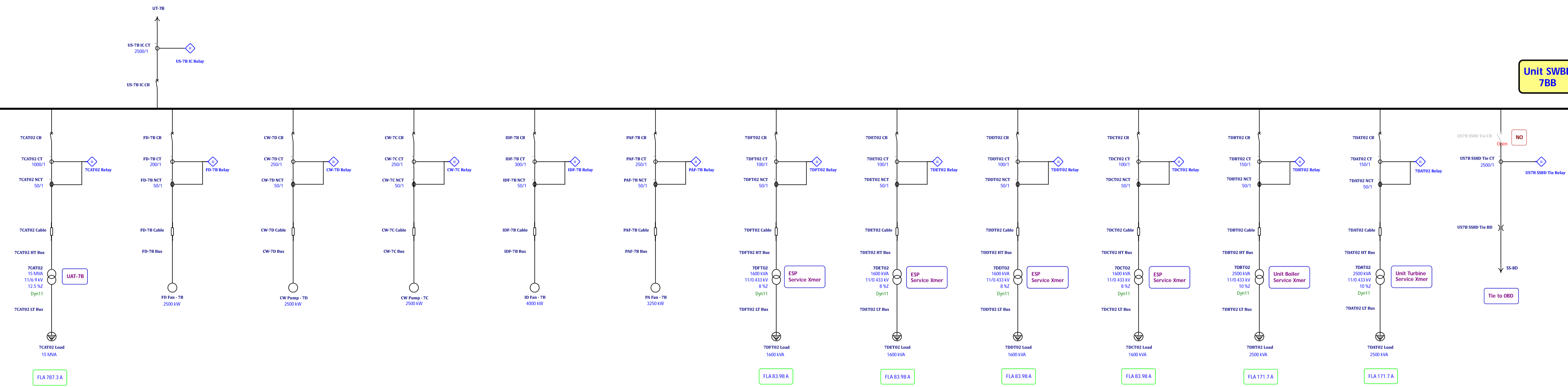

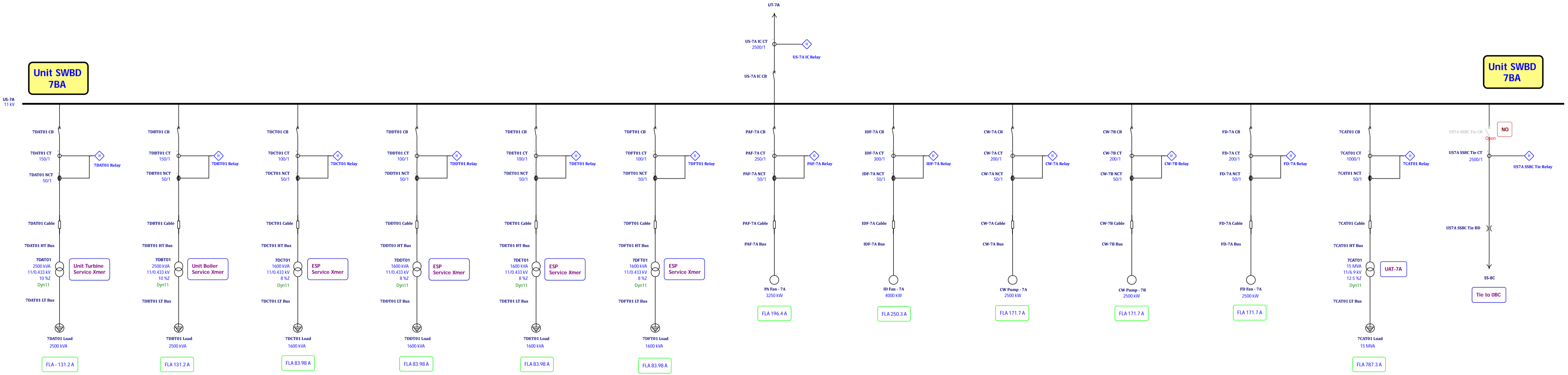

Unit SWBD  
7BA

Unit SWBD  
7BA



Unit SWBD  
8BB

Unit SWBD  
8BB

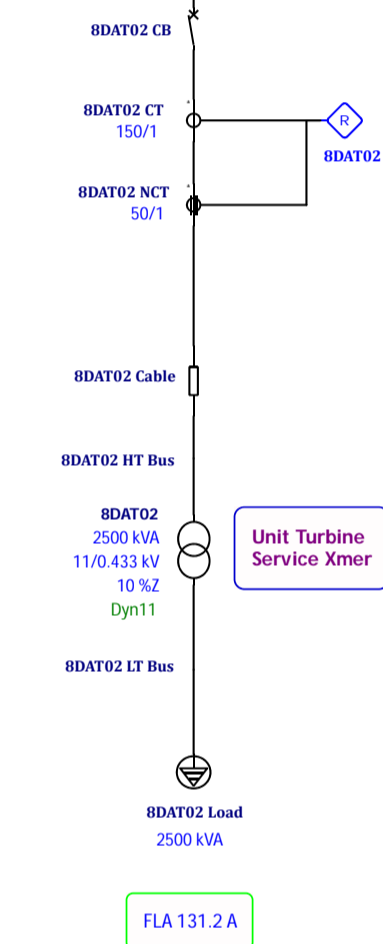
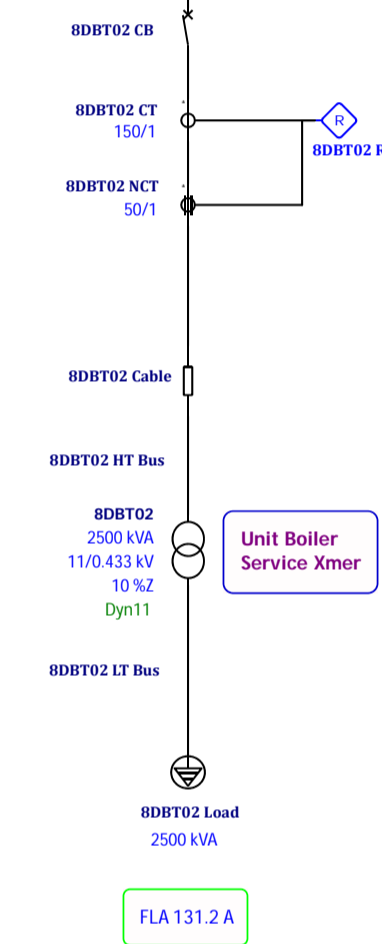
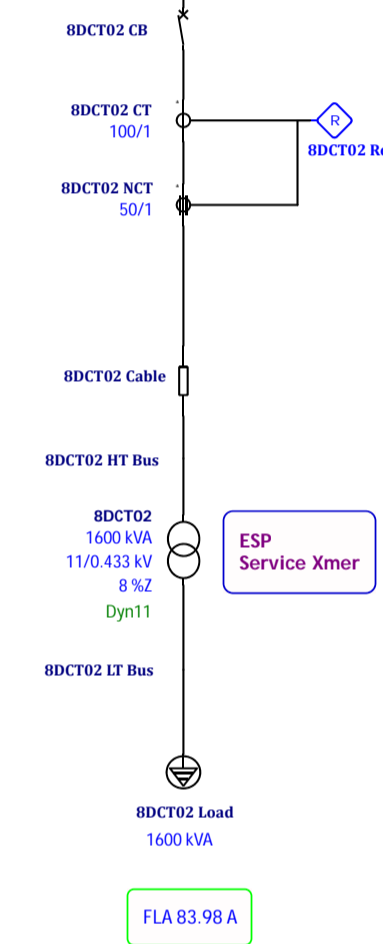
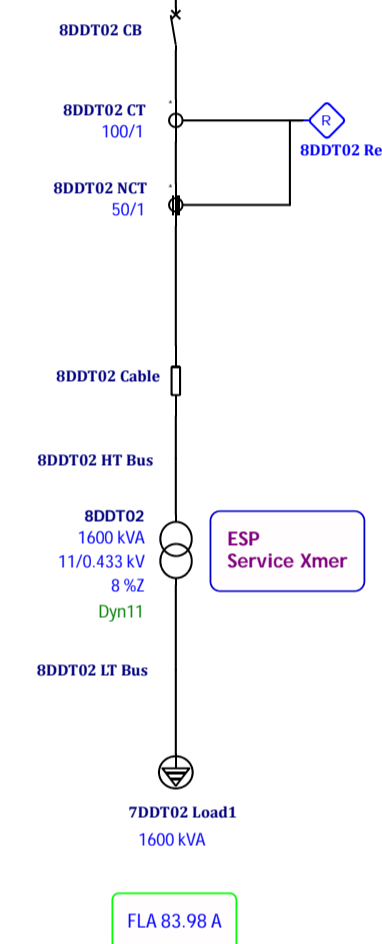
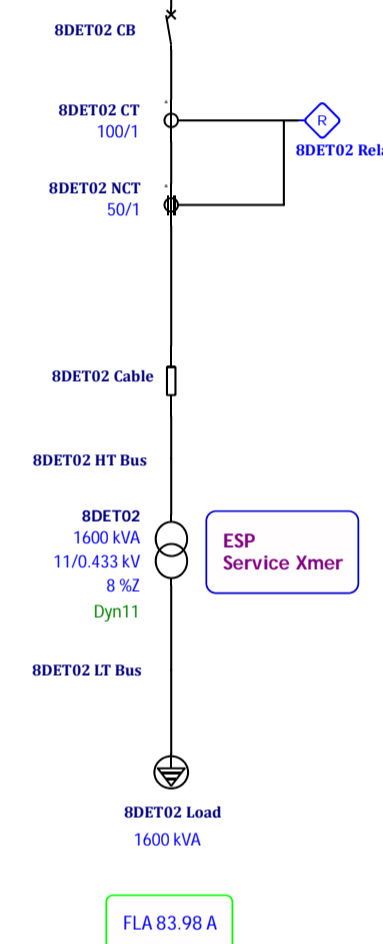
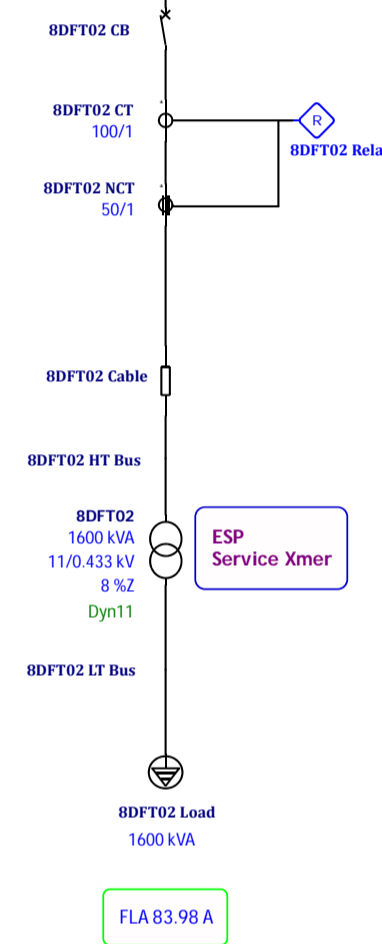
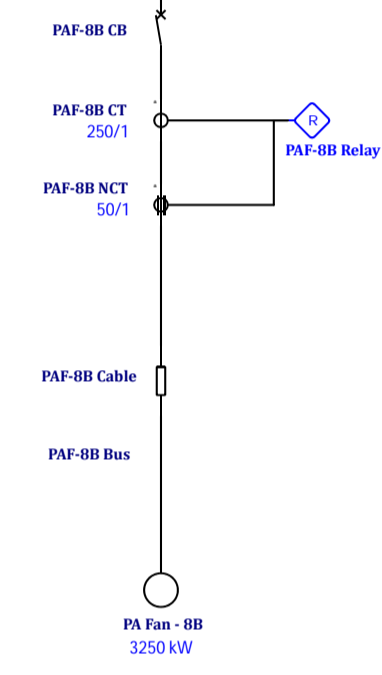
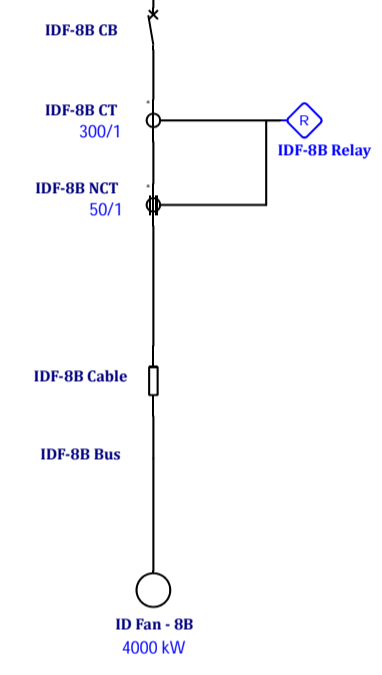
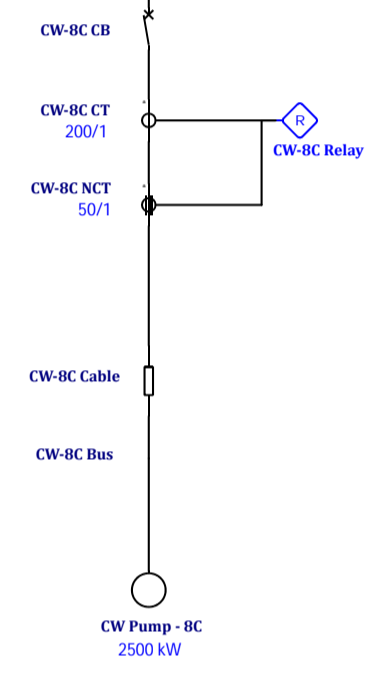
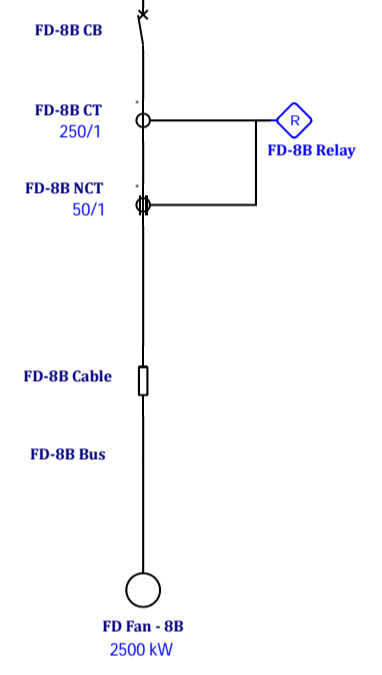
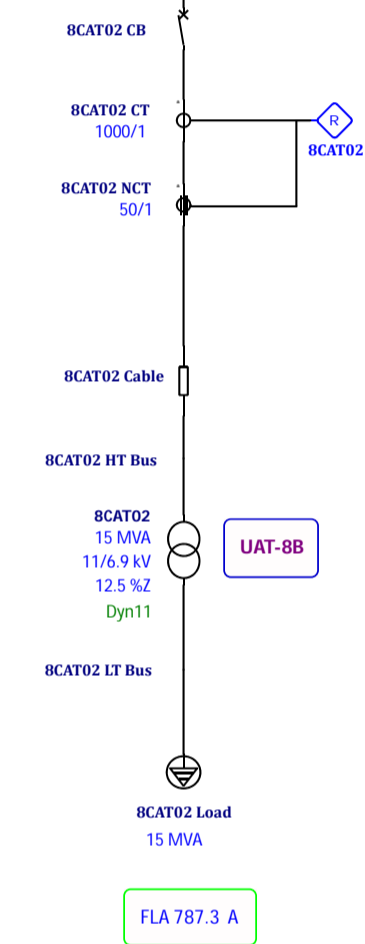
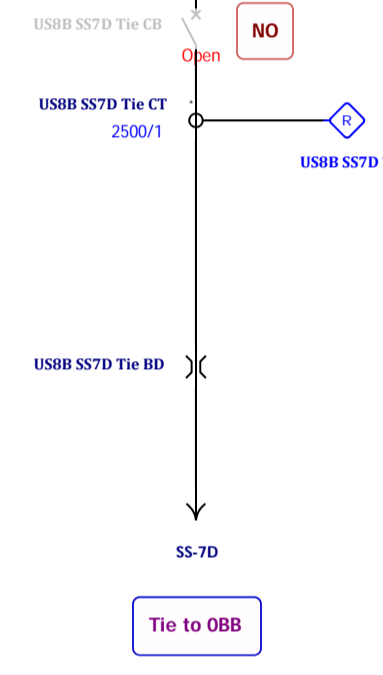
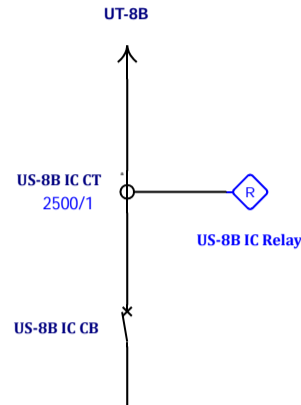

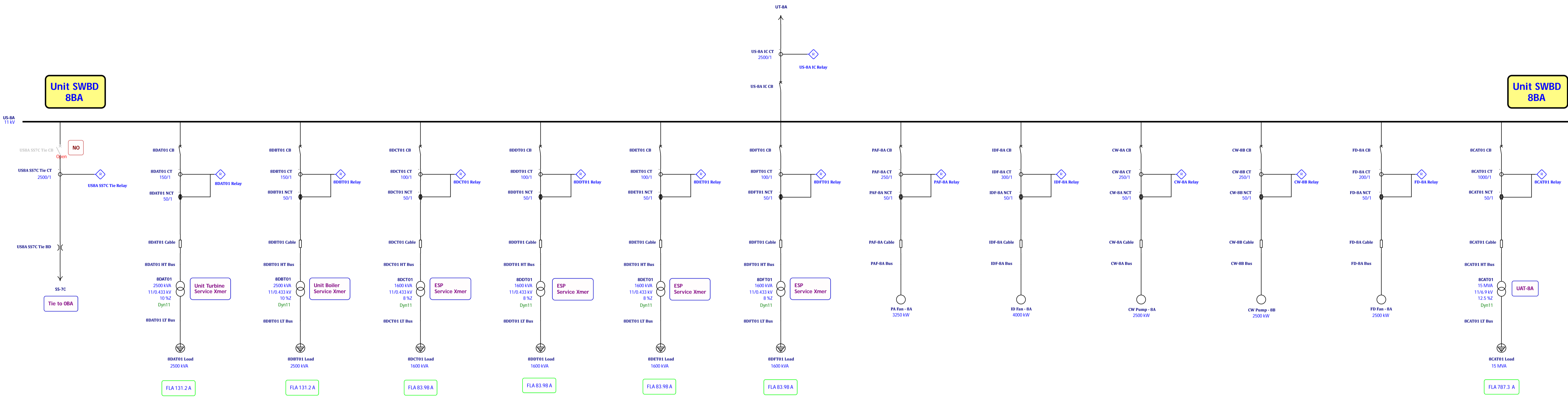

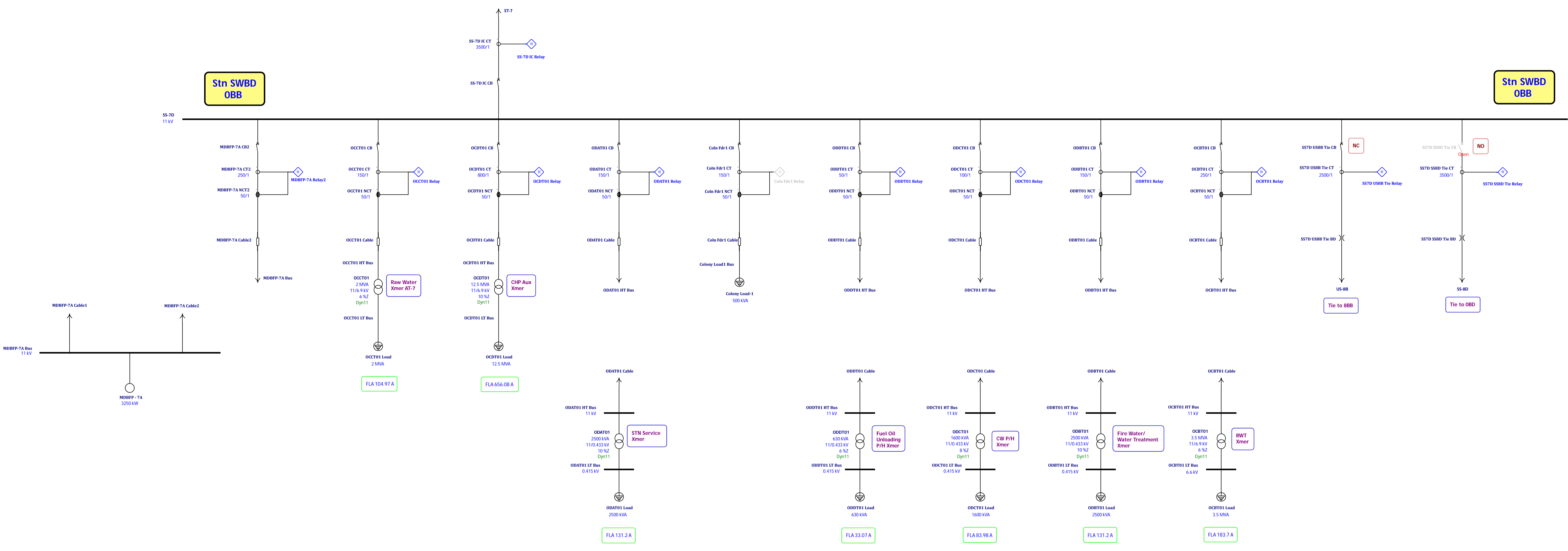

Stn SWBD  
OBA

Stn SWBD  
OBA

SS-7C  
11 kV

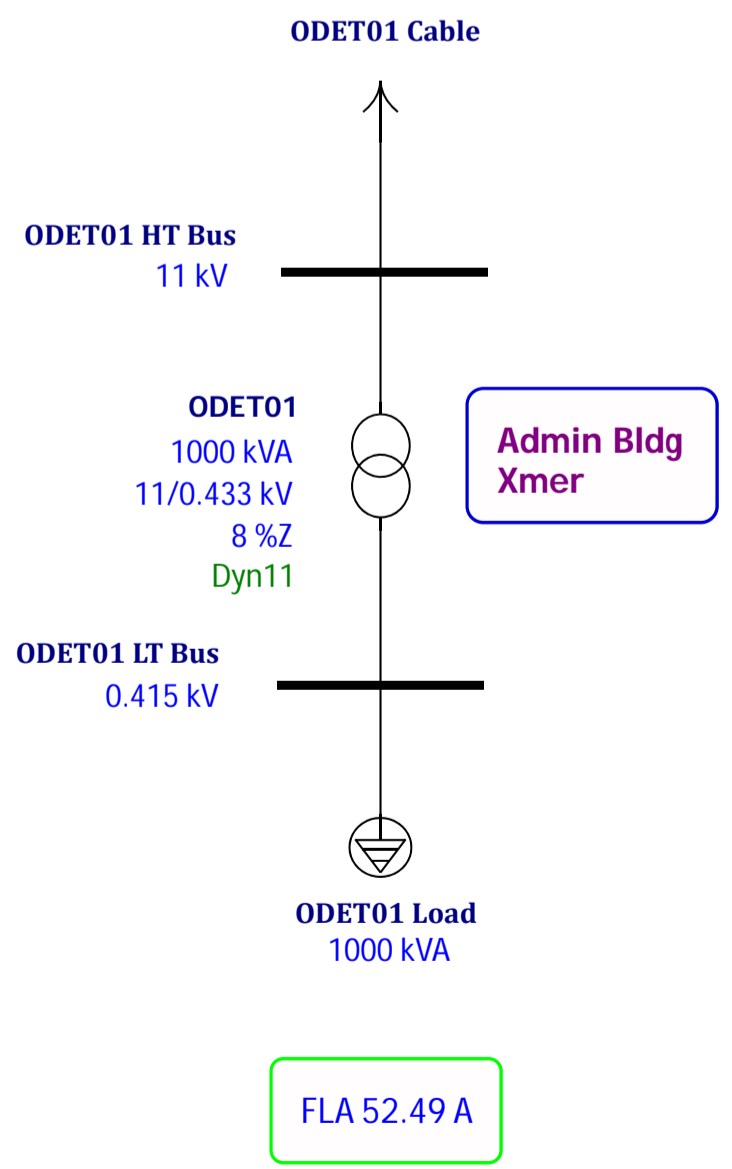
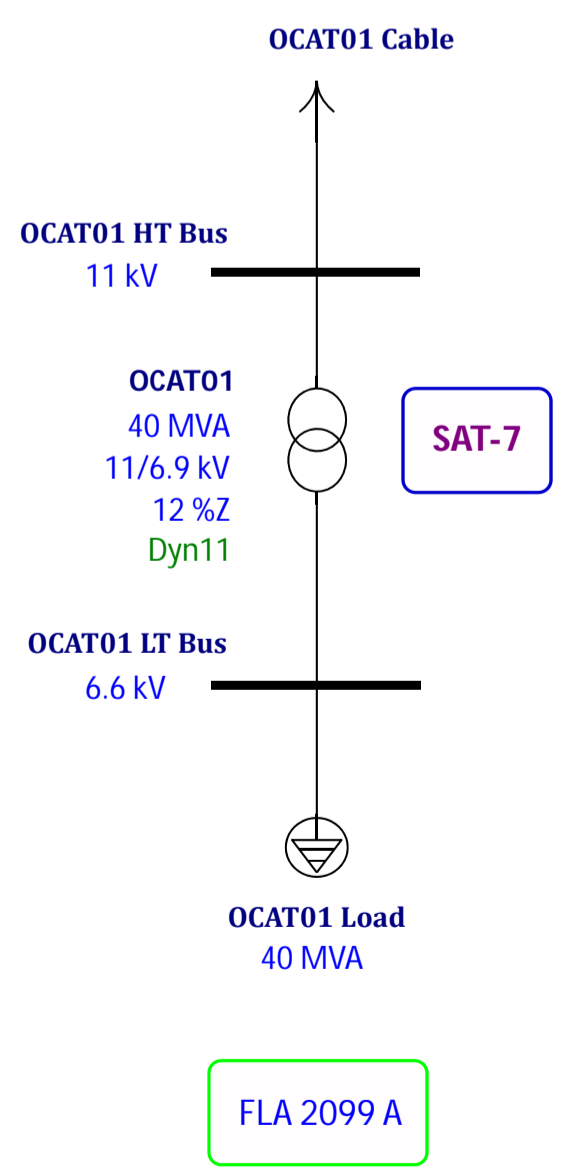
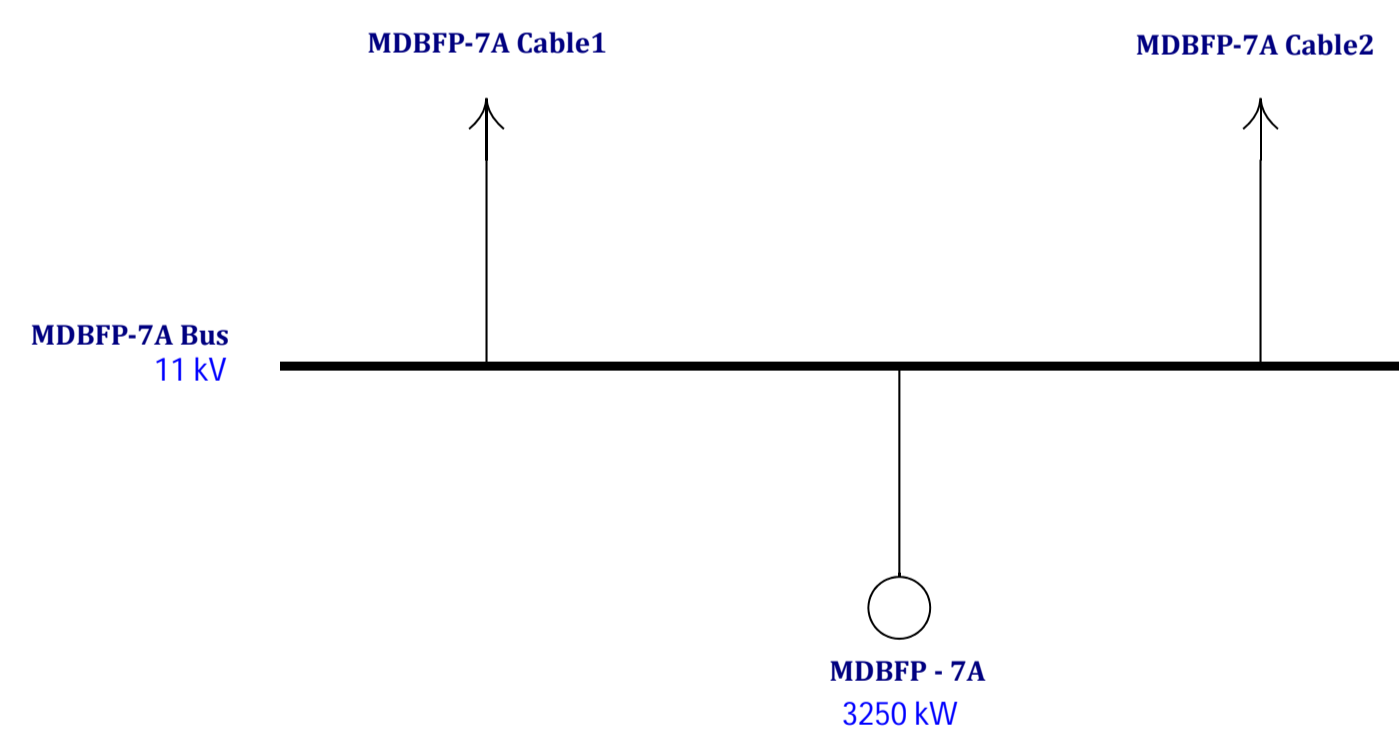
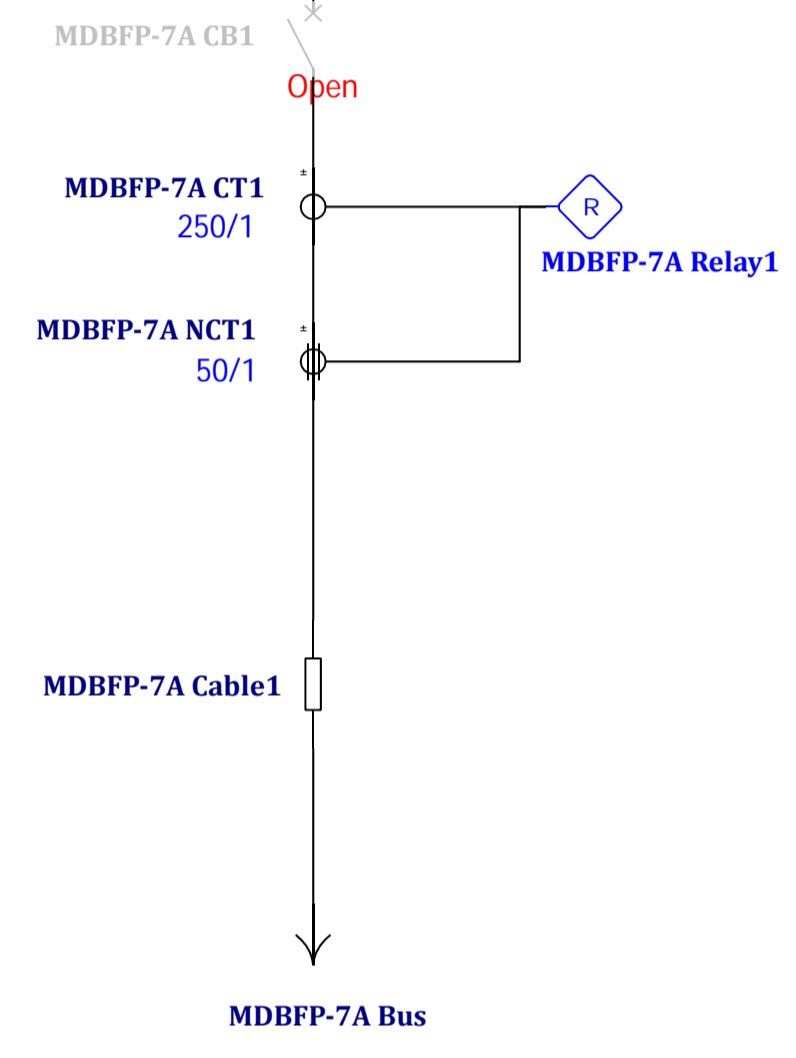
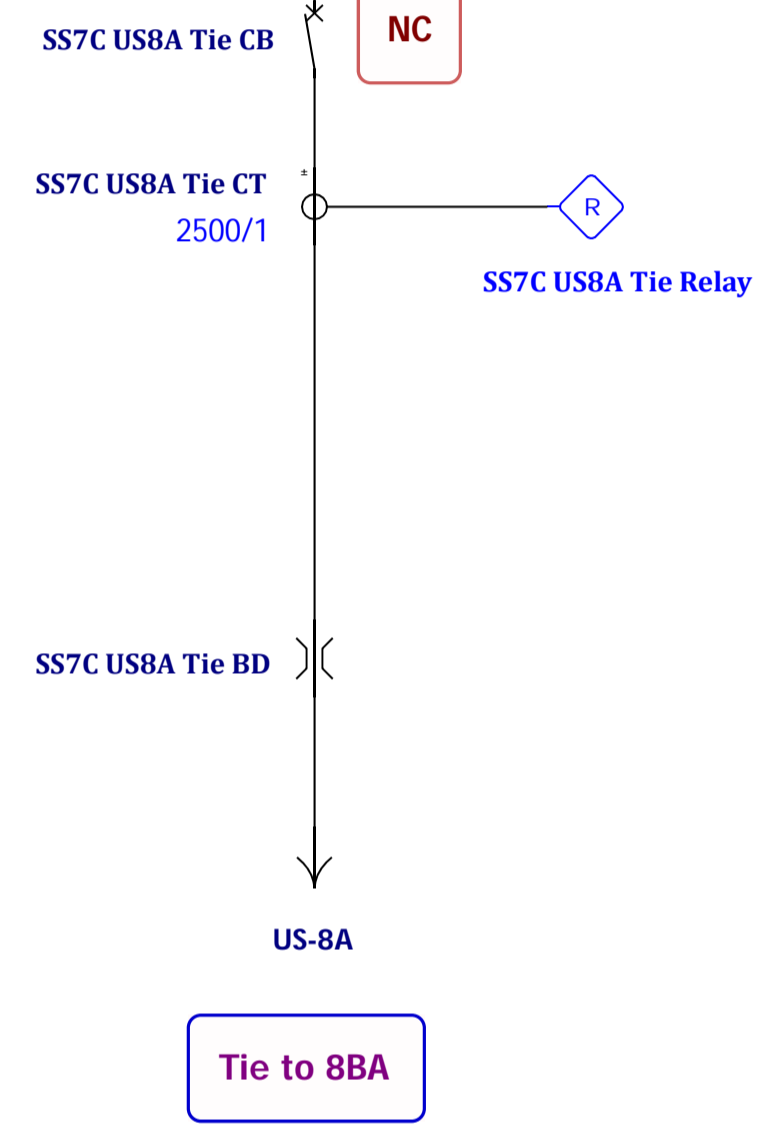
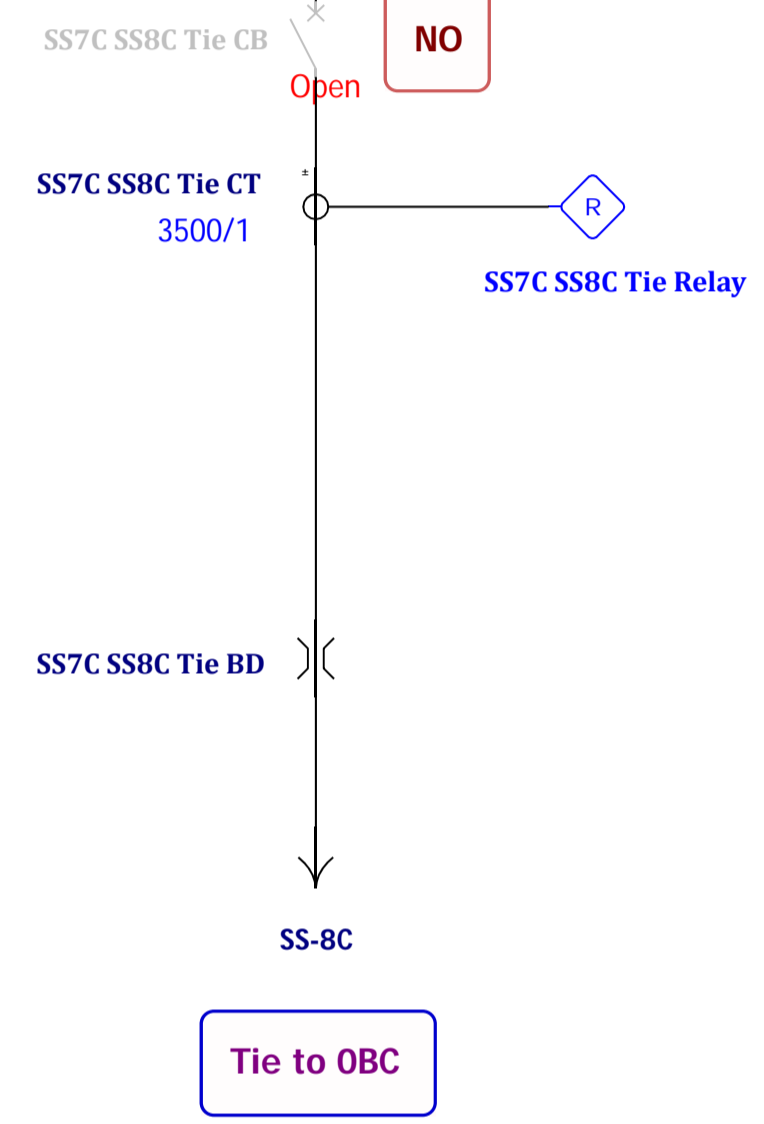
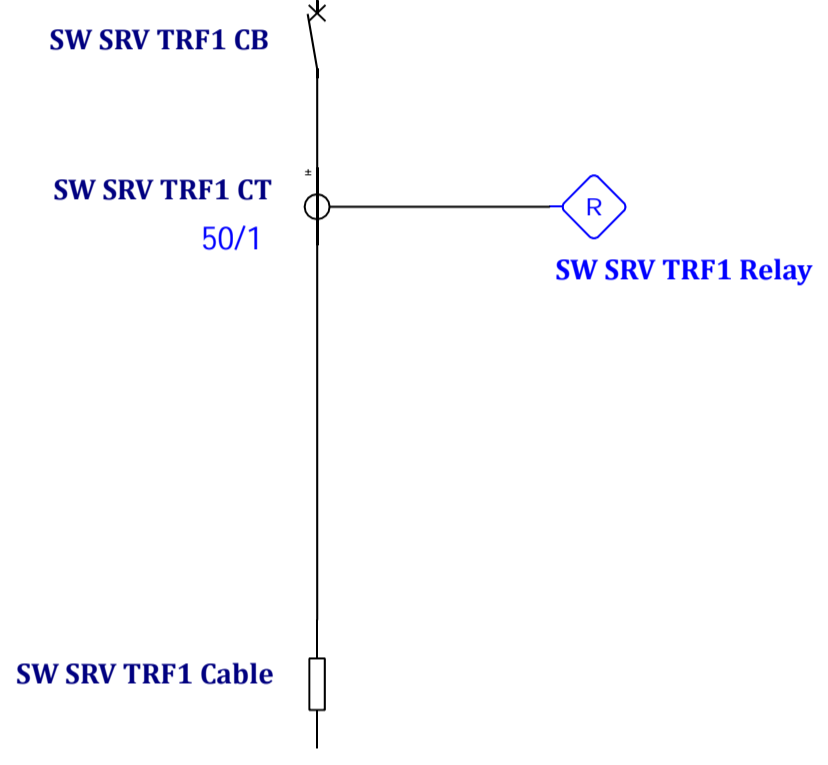
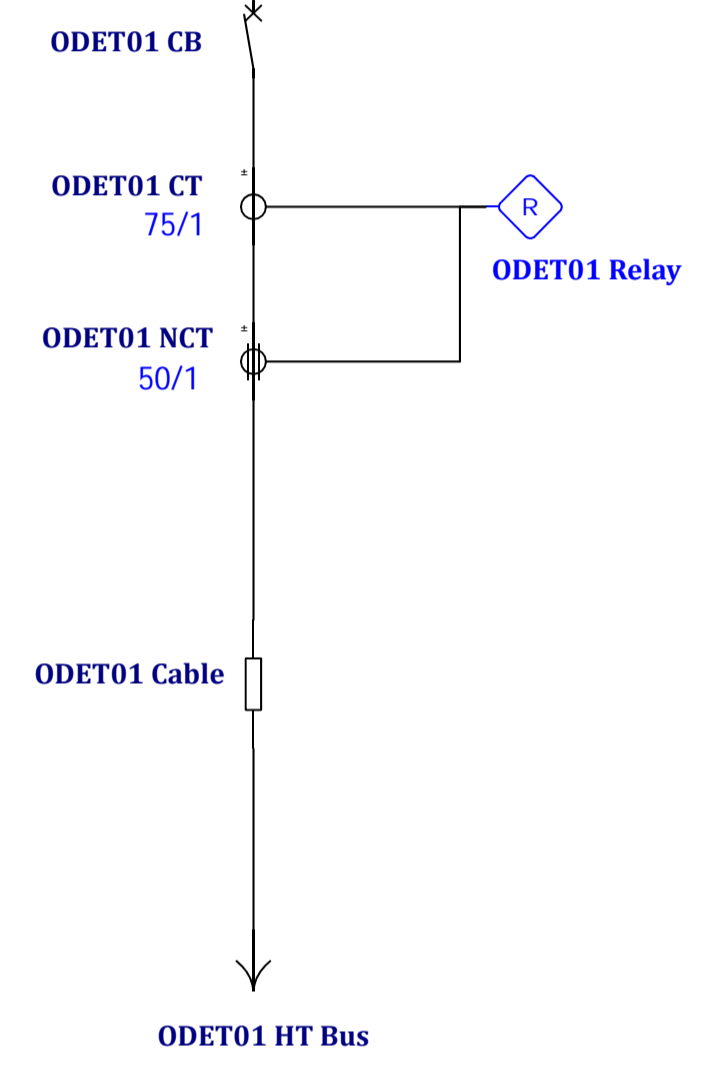
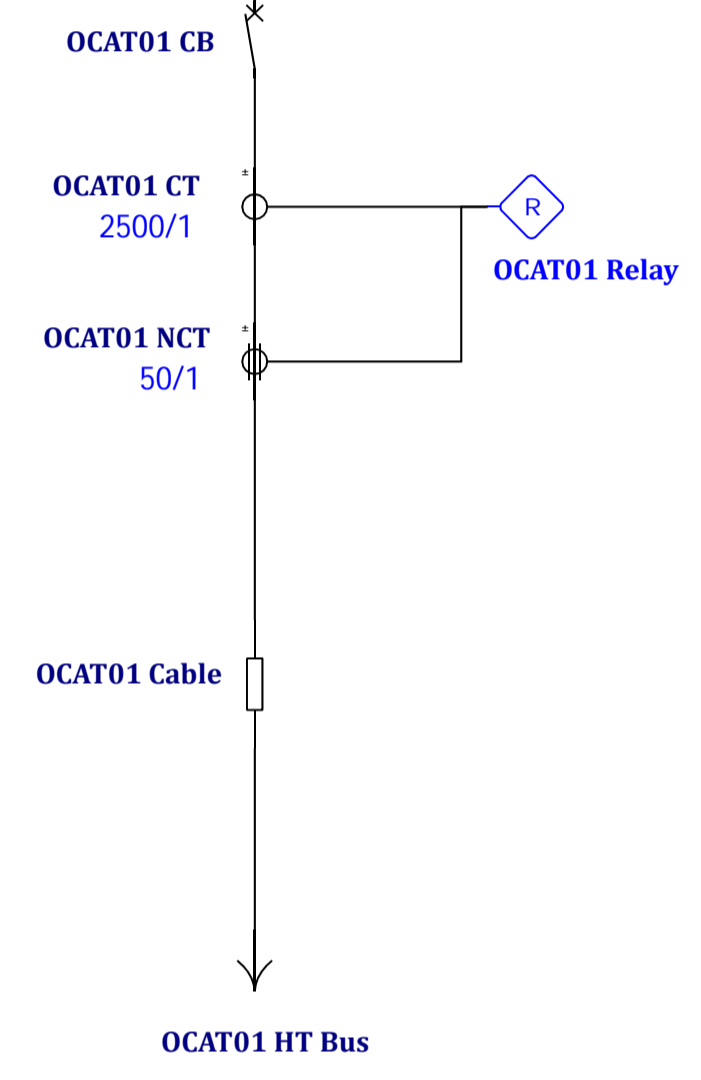
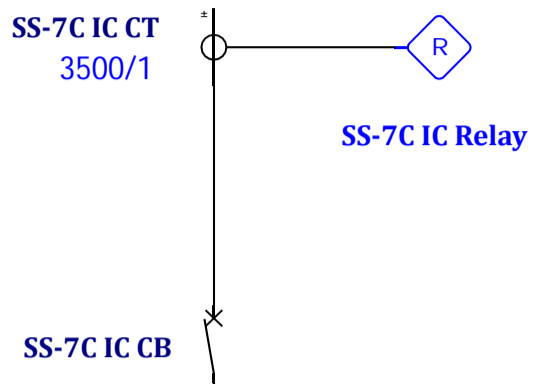

Admin Bldg  
Xmer

SAT-7

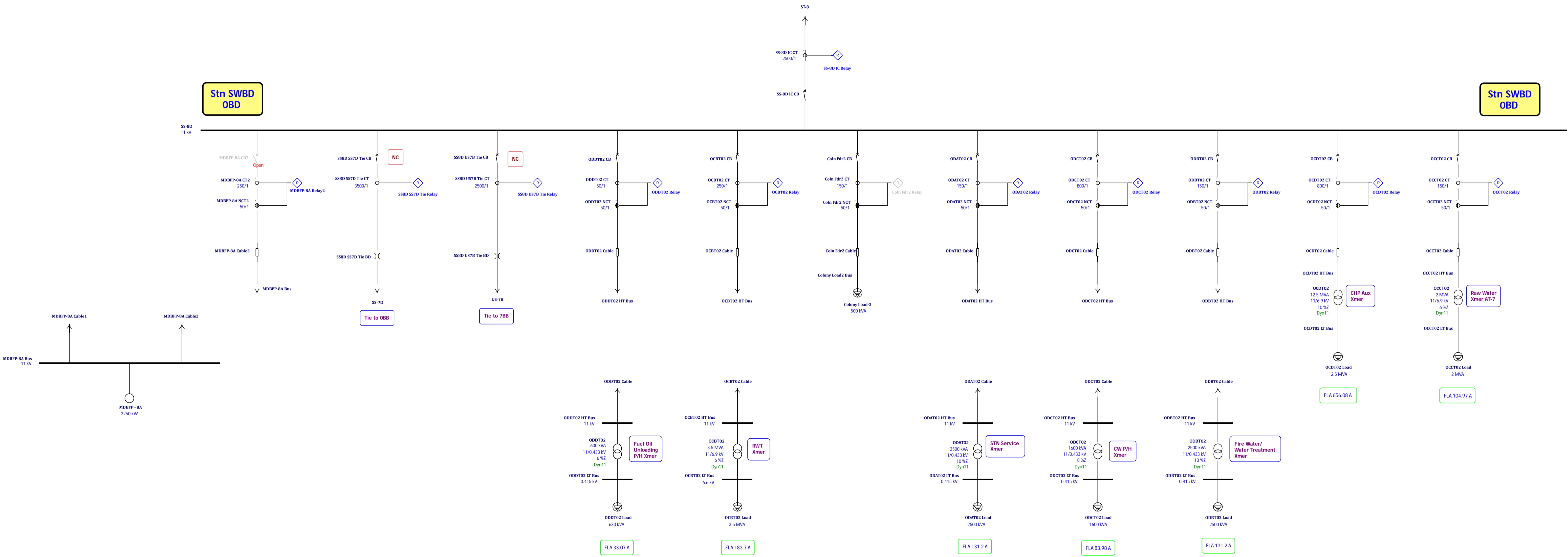

SS-8C  
11 kV

Stn SWBD  
OBC

Stn SWBD  
OBC

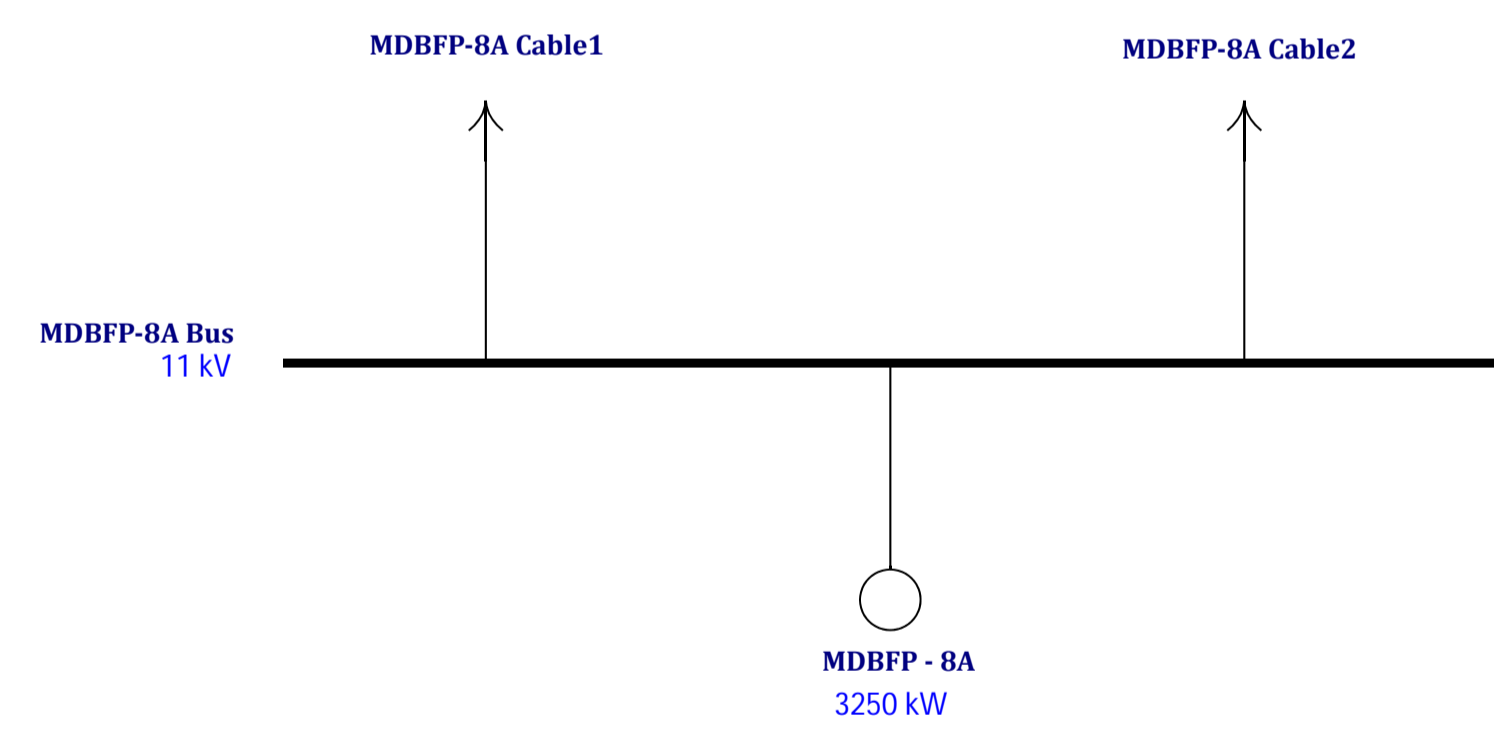
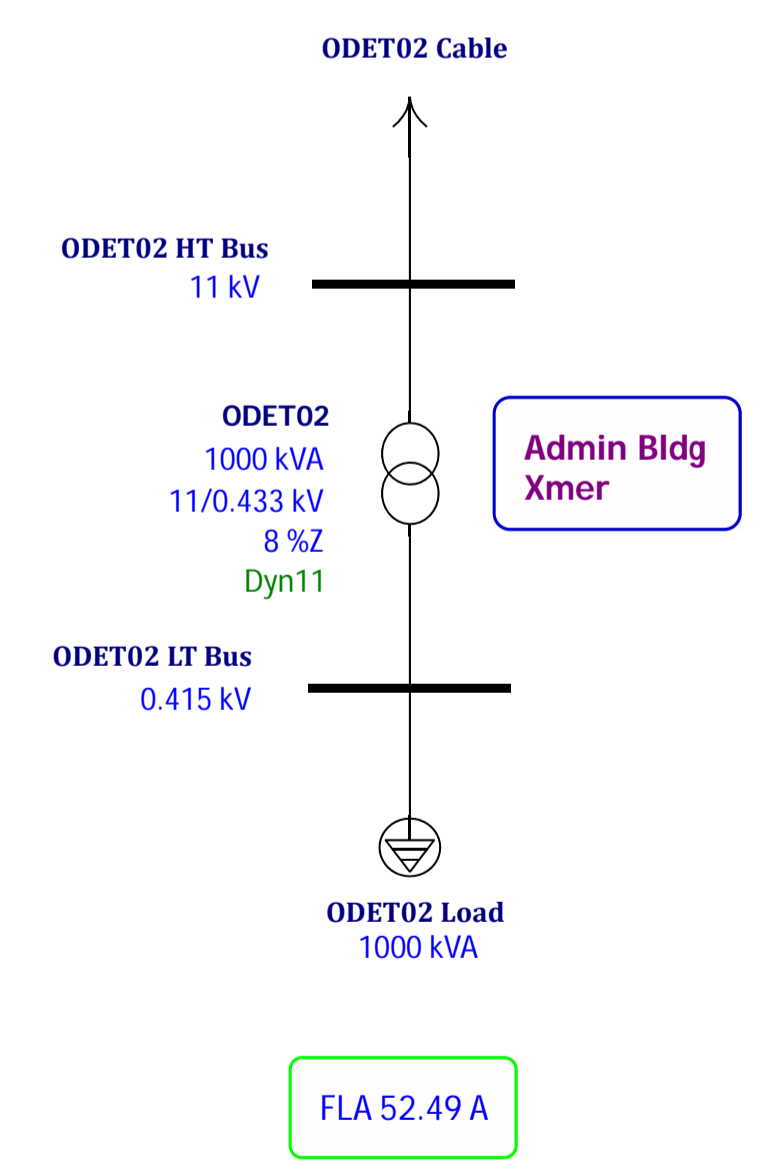
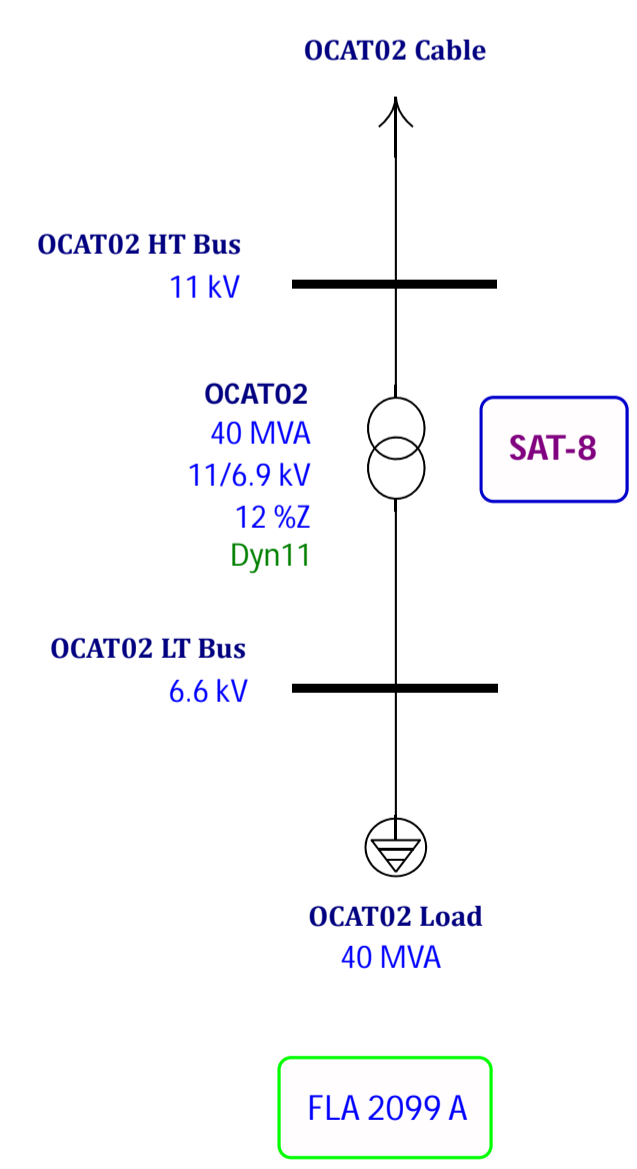
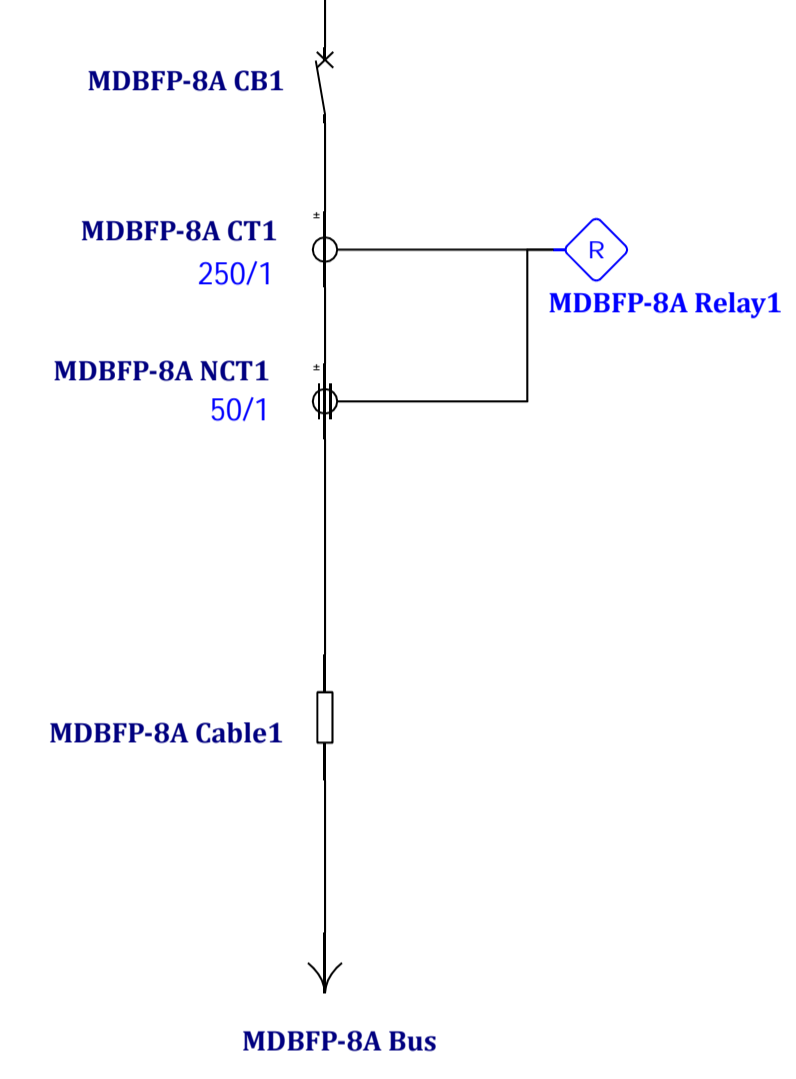
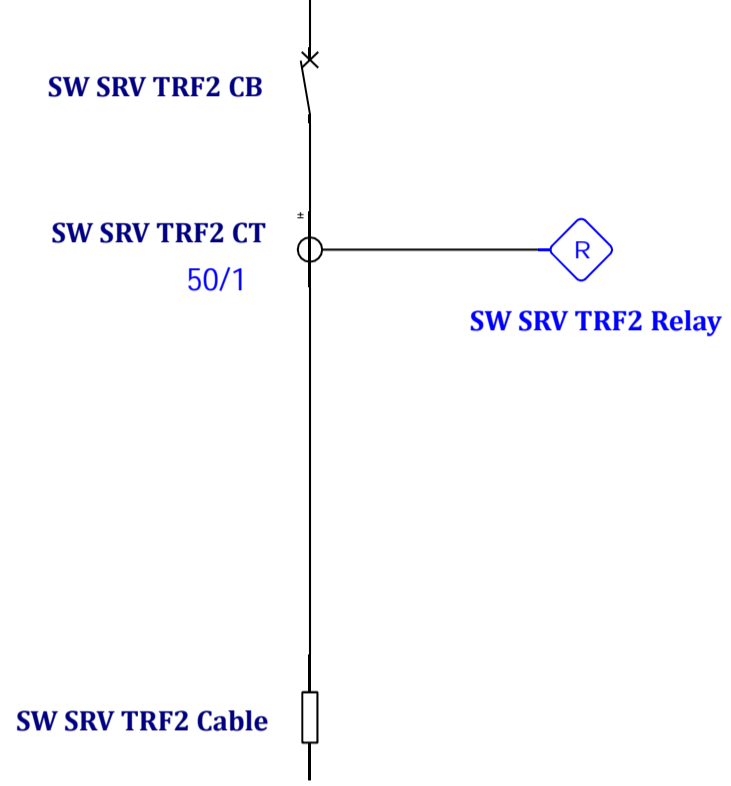
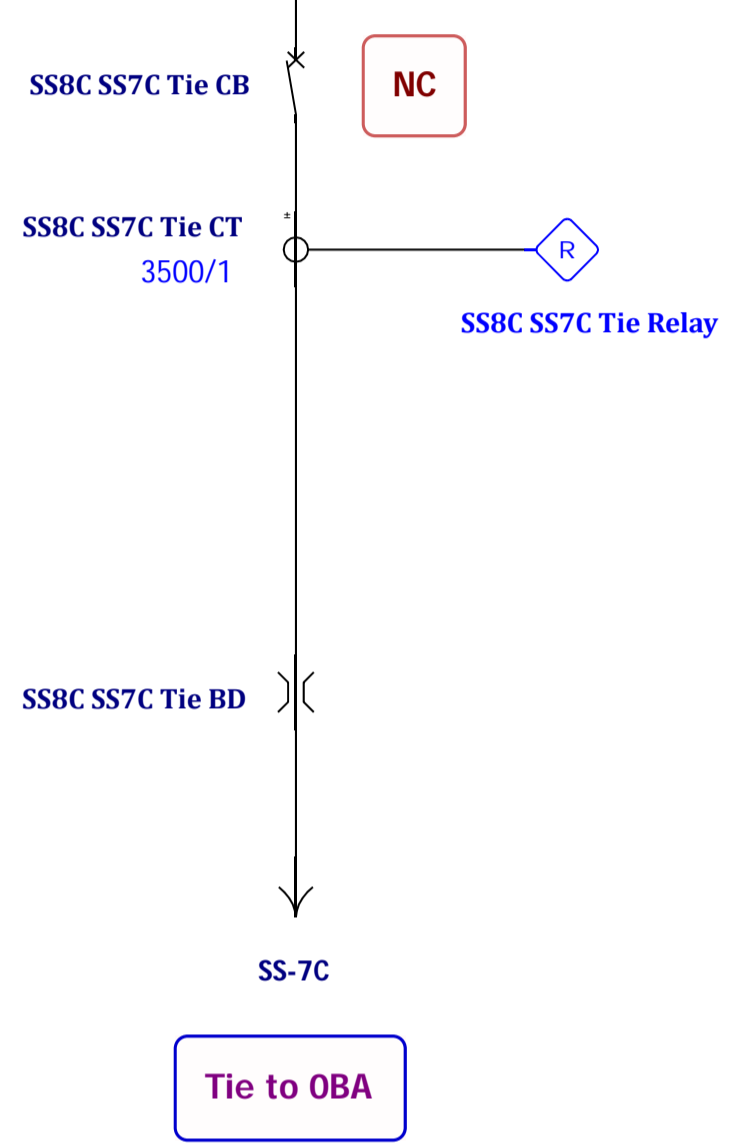
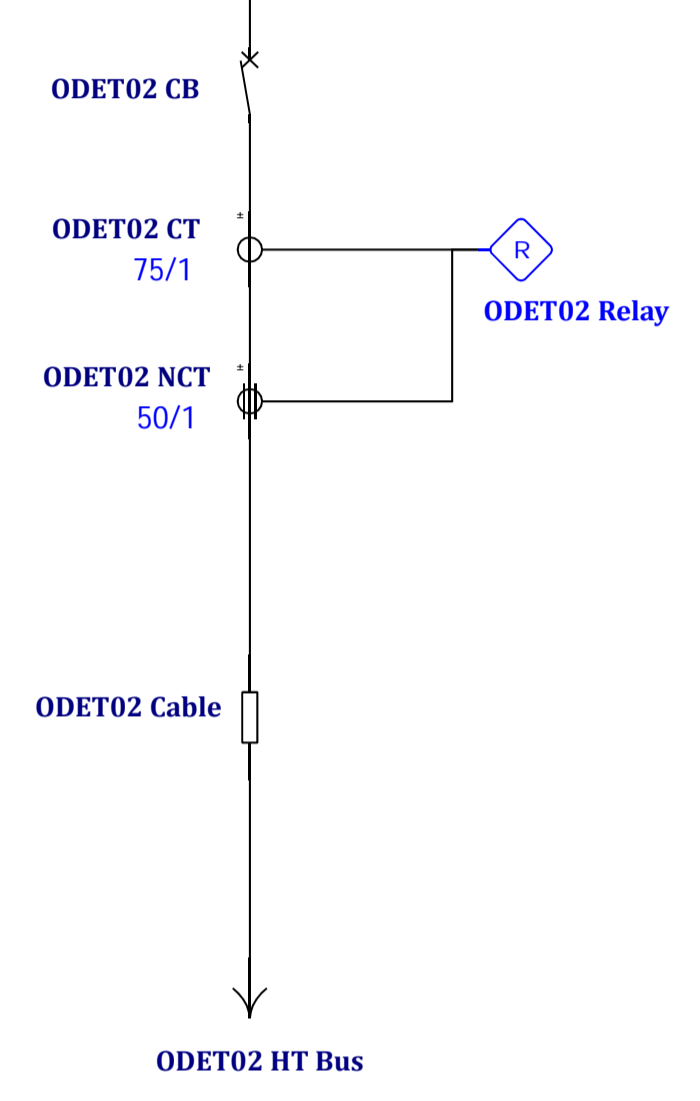
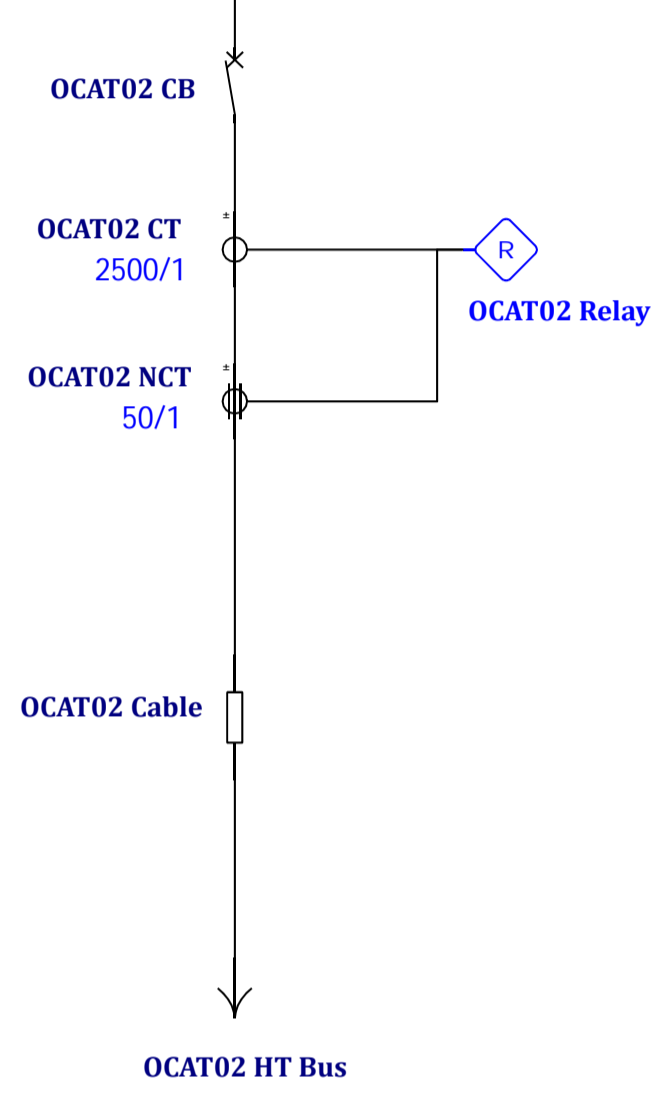
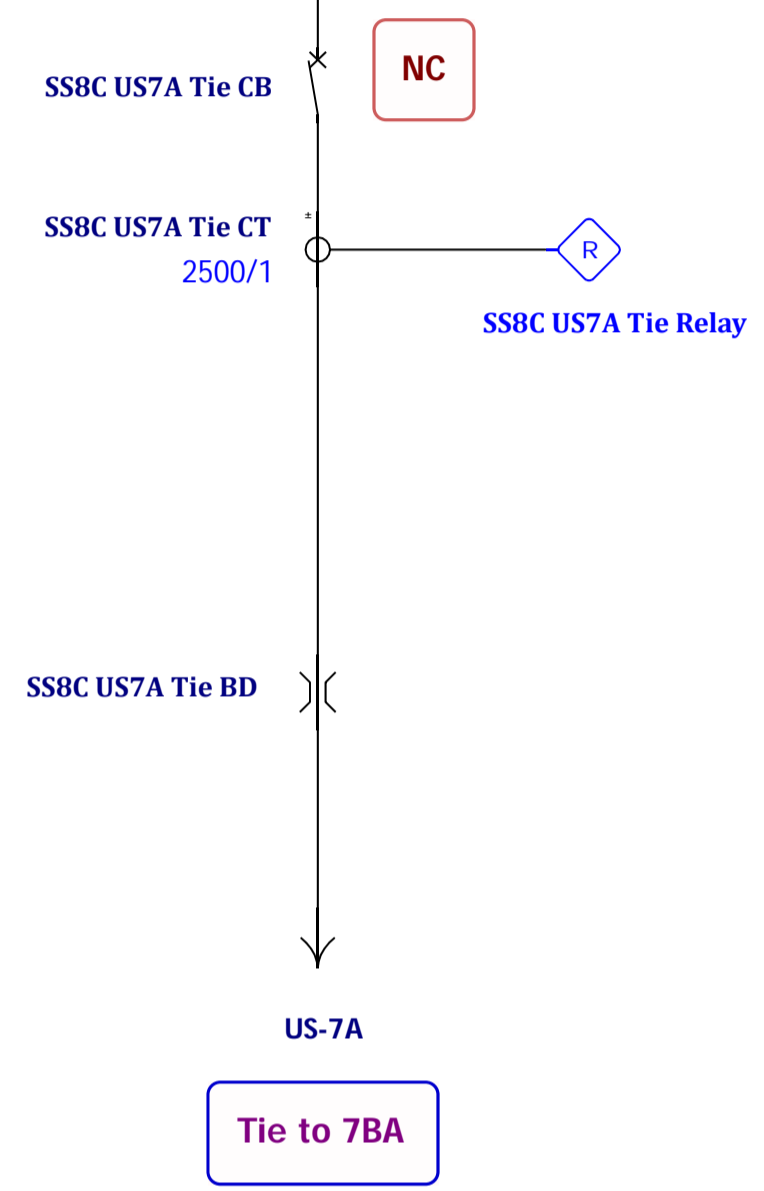
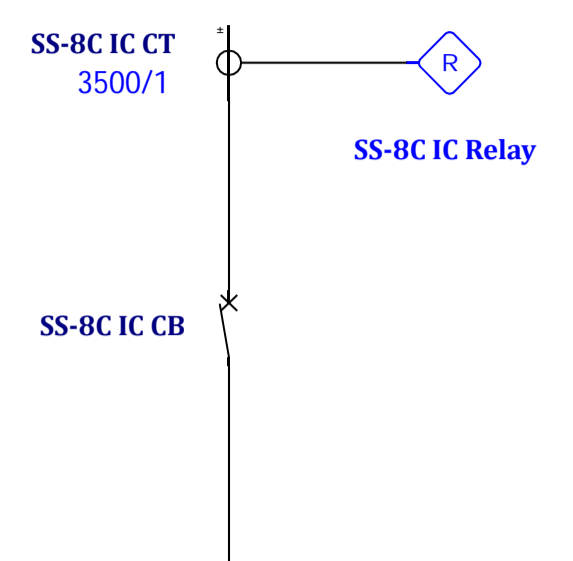



यूजेवीएन लिमिटेड  
(उत्तराखण्ड सरकार का उपक्रम)  
**UJVN LIMITED**

(A Govt. of Uttarakhand Enterprise)

कार्यालय: उप महाप्रबन्धक (सोलर, सामग्री प्रबन्धन एवं अनुबन्ध) गंगामवन, यमुनाकालोनी, देहरादून-248001 दूरभाष-0135-2531762 फ़ैक्ससं० 0135-2531762  
Office of the Dy. General Manager (SOLAR, MM&CM), Ganga Bhawan, Yamuna Colony, Dehradun-248001 Phone-0135-2531762, Fax -0135-2531762  
CIN No. U40101UR2001SGC025866  
ISO 9001:2015, 14001 :2015, 45001 :2018 Certified

**Dy. General Manager (HGC)**  
**UJVN Ltd., Dakpathar,**  
**Dehradun.**

**Subject :-** A Report on Protection Audit conducted by CPRI.

Please find enclosed herewith the report on protection audit conducted by CPRI Bangalore with respect to Chibro Power House Dakpathar, Dehradun.

It is requested to provide comments on the above report and accordingly review the requirement of switchyard equipments etc. under PSDF scheme of GoI.

**(S.K.Baunsiyal)**  
**Dy. General Manager**

**Cc.**

1. ED(O&M) UJVN Ltd., "Ujjwal" GMS Road, Dehradun for kind information.
2. GM(Yamuna Valley-I), UJVN Ltd., Dakpathar.
3. EE(IC&CM) UJVN Ltd. Dehradun in reference to his letter no . 51981 UJVN-D(P)0EDEM(EEIC)/4/2024-e-Office-UJVN Limited Dated 03/01/2024.







यूजेवीएन लिमिटेड  
(उत्तराखण्ड सरकार का उपक्रम)  
**UJVN LIMITED**  
(A Govt. of Uttarakhand Enterprise)

कार्यालय: अधिशासी अभियन्ता(आई0सी0 एण्ड सी0एम0), गंगाभवन, यमुनाकालोनी, देहरादून-248001 दूरभाष-0135-2531762 फैक्ससं0 0135-2531762  
Office of the Executive Engineer (IC&CM), Ganga Bhawan, Yamuna Colony, Dehradun-248001 Phone-0135-2531762, Fax -0135-2531762  
CIN No. U40101UR2001SGC025866

ISO 9001:2008 Certified

**Executive Engineer (Gen/Test)**  
**UJVN Ltd. Chibro Power**  
**House, Dakhpathar.**

**Sub: - Draft report of CPRI Audit.**

Please find herewith the attached document of draft Protection Audit report of CPRI for Chibro Power House Substation. It is request to provide your valuable comments/Suggestion at earliest. So that CPRI may submit their final Protection Audit Report.

**Amit Ranjan**  
**Executive Engineer**

**Copy:- Forwarded for kind information and necessary action.**

1. DGM (Solar, MM&CM) Ganga Bhawan Yamuna Colony, Dehradun.
2. DGM Chibro Power House Dakhpathar.

# **CONSULTANCY REPORT**

## **Protection audit of 220kV Substation at 240 MW Chibro Power House VOLUME-II**

**Clients Reference: PO NO: 5300000132  
CPRI Reference: No. 2/9/PSD/UJVNL/2022-23  
CPRI Report: No. 2/9/PSD/RT99/2023**

**CUSTOMER**  
**M/s UJVNL, Dehradun**

### **CONSULTANT**



**POWER SYSTEMS DIVISION  
CENTRAL POWER RESEARCH INSTITUTE  
Sir. C.V.RAMAN ROAD, P.B. NO. 8066  
SADASHIVANAGAR P.O  
BANGALORE – 560 080.  
Website : <http://www.cpri.res.in>  
November 2023**



**POWER SYSTEMS DIVISION**  
**CENTRAL POWER RESEARCH INSTITUTE**  
**Sir. C.V. RAMAN ROAD P.B.No.8066, BANGALORE 560080**  
Website: <https://cpri.res.in>

Ref. File No.: 2/9/PSD/UJVNL/2022-23

Dated.13-12-2023

<b>Title</b>	<b>Third Party Protection audit at for 220kV Substation at 240 MW Chibro Power House</b>
Project Objectives	Review Of Protection Scheme, Relay Settings Of Various Element & Associated System Of for 220kV Substation at 240 MW Chibro, Power House
Name and Address of the Customer	M/S UJVNL, Dehradun
Client's Reference and Date	5300000132 Date :11.08.2023
CPRI report No:	2/9/PSD/RT99/2023
Name(s) of investigator(s) from CPRI	1. Dr J. Sreedevi, Joint Director & HOD 2. Mr. Ved Prakash Yadav, Engineering Officer
Name of UJVNL, Dehradun officers, associated in providing support to CPRI	1.Mr. Anup Deepak, Executive Engineer(test), Dakpathar 2.Mr. Anand Kumar, Executive Engineer (Generation), KPS 3.Mr. Amit Ranjan, Executive Engineer(MM&C) 4. Mr. Arvind Bahuguna, Asst Engineer, M & FDR 5. Mr. Ajai Kumar Singh, Asst Engineer (test) 6. Mr. Sudhir Kumar, Asst Engineer (EM)
Report contains	Number of pages : 19
Report Reviewed by:  Mr.Ved Prakash Yadav Engineering Officer Power Systems Division, CPRI  Signature:	Report Approved by:  Dr. J. Sreedevi Joint Director & HoD Power Systems Division, CPRI  Signature:

## **ACKNOWLEDGEMENT**

CPRI wishes to thank UJVNL, Dehradun, for awarding the contract of Third Party Protection audit of *220kV Substation at 240 MW Chibro Power House* PO No. 5300000132 Date :11.08.2023 to CPRI. CPRI wishes to thank all the Officers/Engineers of UJVNL Dehradun, who were associated in this work for their co-operation in providing the required data and for their interaction during the visit to the substation. CPRI Team specially thank the following personnel for their excellent co-operation without which this work would not have been possible,

1. Mr. Shri Anup Deepak, Executive Engineer(test), Dakpathar
2. Mr. Mandeep Singh, Executive Engineer (Generation), KPS
3. Mr. Amit Ranjan, Executive Engineer(MM&C)
4. Mr. Arvind Bahuguna, Asst Engineer, M & FDR Prtn
5. Mr. Vedpal Arya, Asst Engineer (test)
6. Mr. Sharad Raghuvanshi, Asst Engineer (EM)

## Minutes of Meeting

MOM Between	Date
CPRI, Bangalore & M/s UJVNL	11/10/2023

### 1. Participants:

Organization	Name
CPRI, Bangalore	Dr J.Sreedevi, Joint Director Shri Ved Prakash Yadav, Engineering Officer
UJVNL	Shri Anup Deepak, Executive Engineer(test), Dakpathar Shri Anand Kumar, Executive Engineer (Generation), CPS Shri Amit Ranjan, Executive Engineer(MM&C) Shri Arvind Bahuguna, Asst Engineer, M&FDR Prtn Shri Ajai Kumar Singh, Asst Engineer (test) Shri Sudhir Kumar, Asst Engineer (EM)

### 2. Meeting Details:

Subject:	Visit for Protection Audit of M/s UJVNL Chibro Power House
Reference:	PO. No. 5300000132 dated: 11/08/2022

### 3. Notes of Meeting:

- CPRI officials visited Chibro substation on 11/10/2023 and briefed about the protection audit of the M/s UJVNL, Chibro Power House Switchyard.
- During the protection audit work, the existing setting of lines and GTs were taken for all the electro-mechanical type relay for setting calculations
- It is observed that following protections are electro-mechanical type which needs to be replaced/added with the latest numerical relays (IEDs) :
  - Bus bar protection:
    - Bus bar super vision relay type VTX 95A, 95B, 95CH;
    - Differential Protection 87A, 87B, 87CH,
    - Auxiliary relays 95AX, 95BX, 95CHX
    - Trip circuit supervision relays 95AY, 95BY, 95CHY
    - Interlock over current relay 51B1
    - Tripping Relay : 13 No.( 96A, 96B, 96C to 96H)
  - Synchronizing relay
  - Bay control Unit is not available in the substation
  - Generator Transformer Protection:
    - HV standby earth fault relay 64GTS
    - HV & LV restricted earth fault relay 64GTR, 64UTR
    - Overall differential relay 87GT

- It is observed that SANDS make time synchronization unit is available for 220 kV system but all the available IEDs are not time synchronized due to lack of time sync provision in few relays such as ABB REL511 & ABB REL521 and EM type relays.
- CPRI Officers went around 220kV Switchyard to check the maintenance of the substation and measured the DC voltage (lead acid) in CB panel as below.

	Positive to Negative	Positive to Earth	Negative to Earth
DC Bank 1	232.50	+130.10	-102.10

- It is observed that two DC sources are available but only one source is extended to the switchyard. This needs to be attended at the earliest.
- It is observed that the PLCC on Khodri - Chibro lines for tandem operation of generators which was commissioned in 2005-06 is obsolete and spares are not available. It is very much important to have a healthy PLCC communication for tandem operation and needs to be replaced.
- It is observed that the testing of CT, CVT and PT was done during commissioning time.
- Testing of Electro mechanical protection relays and CBs have been done periodically. The test report of the same are available for 220 kV system and reviewed.
- It is recommended that Tan delta and Insulation resistance test shall be performed for the CT, CVT & PT during the routine test to analyze the healthiness of the equipment
- It is recommended that the all the Numerical Protection IEDs shall be tested once in 3/4/5 years as per the best practices adopted by the other organization such as PGCIL etc.
- Switchyard of 220 kV Chibro switchyard is being maintained properly and it is neat and clean.

The CPRI audit team thanked to the personnel of Chibro power house arranging the protection audit.

For CPRI

*J. Sreedevi*  
11/10/23

For UJVNL

*Anil*  
11-10-23

# 1. Executive Summary

Power Systems Division of Central Power Research Institute conducted the third party protection audit of 220kV Substation at 240MW Chibro Power House as per the PO No. 5300000132 Date :11.08.2023. The different protection that were covered under the audit are (i) Distance Protection (ii) ICT Protection and (iii) Bus bar Protection. It also included the checking of (i) DC Supply (ii) AC Supply with DG (iii) Communication system with DR (iv) Circuit Breaker (v) CT and (vi) CVT (vii) Synchro-Check. The audit format was provided by CPRI and the respective data was filled by the substation officers.

This report pertains to the audit carried out for **220kV Substation at 240MW Chibro Power House**. The protection audit of the substation was carried out on 11-10-2023, have (a) Two 220 kV transmission lines (b) Four GT's After viewing the downloaded settings at substation for lines, transformer and busbar most of the settings are found to be in line with the recommended settings as per guidelines. However, some of the deviations found are given below:

1. The distance protection Main I & Main II, Zone 1 impedance reach setting for Chibro-Khodri I are properly set and some revisions are required in Zone 2 & Zone 3 impedance reach settings.
2. The distance protection Main-I & II of Zone 1 impedance reach setting for Chibro-Khodri II lines are properly set and some revisions are required in Zone 2 & Zone 3 impedance reach settings.
3. The earth fault protection is also protected to all line protection. Power swing, CB fail, and broken conductor is also provided on all lines. Minor changes in Power swing.
4. Resistive reach for Ph-Ph & Ph-Gnd to be reviewed for all the Lines. Since, For the calculation of resistive reach (Ph-Ph & Ph-Gnd), CPRI considered the Arc Resistance and Tower footing resistance as 28.864  $\Omega$  & 10  $\Omega$  respectively. If the Arc Resistance and Tower footing resistance values are different at the substation based on local substation condition, then all resistive reach (Ph-Ph & Ph-Gnd) same setting may be retained.

5. Other Protection functionality for lines like broken conductor Voltage supervision and Carrier communication are working satisfactory.
6. The differential protection setting for transformers are properly set and stable.
7. The differential protection setting for busbar are properly set and stable.
8. Relay coordination has been reviewed and some minor variation is required for few settings. The same has been provided in relay coordination sheet.
9. It is suggested to perform the third-party protection audit of substation/generating station periodically.



## CONTENTS

<b>220 kV SWITCHYARD CHIBRO POWER HOUSE UJVNL</b>		
<b>Sl. No.</b>	<b>Description</b>	<b>Page No</b>
1.0	LINE DIAGRAM OF 220kV CHIBRO POWER HOUSE	1
1.1	PROTECTION SYSTEM OVERALL REVIEW	2
1.2	RELAYS USED FOR TRANSMISSION LINE, TRANSFORMER, REACTOR AND BUS BAR PROTECTION SUBSTATION	4
1.2.1	RELAYS USED FOR TRANSMISSION LINE PROTECTION	4
1.2.2	RELAYS USED FOR TRANSFORMER PROTECTION	4
1.2.3	RELAYS USED FOR BUSBAR PROTECTION	5
2.0	INPUT DATA FOR TRANSMISSION LINES	6
2.1	INPUT DATA FOR TRANSMISSION LINES SUBSTATION CHIBRO - KHODRI I	6
2.2	INPUT DATA FOR TRANSMISSION LINES SUBSTATION CHIBRO - KHODRI II	8
3.0	TRANSMISSION LINE PROTECTIVE RELAY SETTINGS REVIEW	10
4.0	INPUT DATA FOR TRANSFORMER PROTECTION	12
4.1	TRANSFORMERS PROTECTION RELAY SETTING REVIEW	15
5.0	DC MEASUREMENTS	16
6.0	STUDY RESULTS OF FIELD INSPECTION OF EXISTING PROTECTION DEVICES FOR OBSOLESCENCE OF TECHNOLOGY, SUITABILITY, HEALTHINESS	17
7.0	PROTECTION REVIEW AND RECOMMENDATIONS	18
8.0	REVIEW OF TEST REPORTS	19

# 1.0: LINE DIAGRAM OF 220kV CHIBRO POWER HOUSE (4X60 MW).

**LOCATION OF ABT ENERGY METERS AT 4X60 MW CHIBRO POWER STATION**

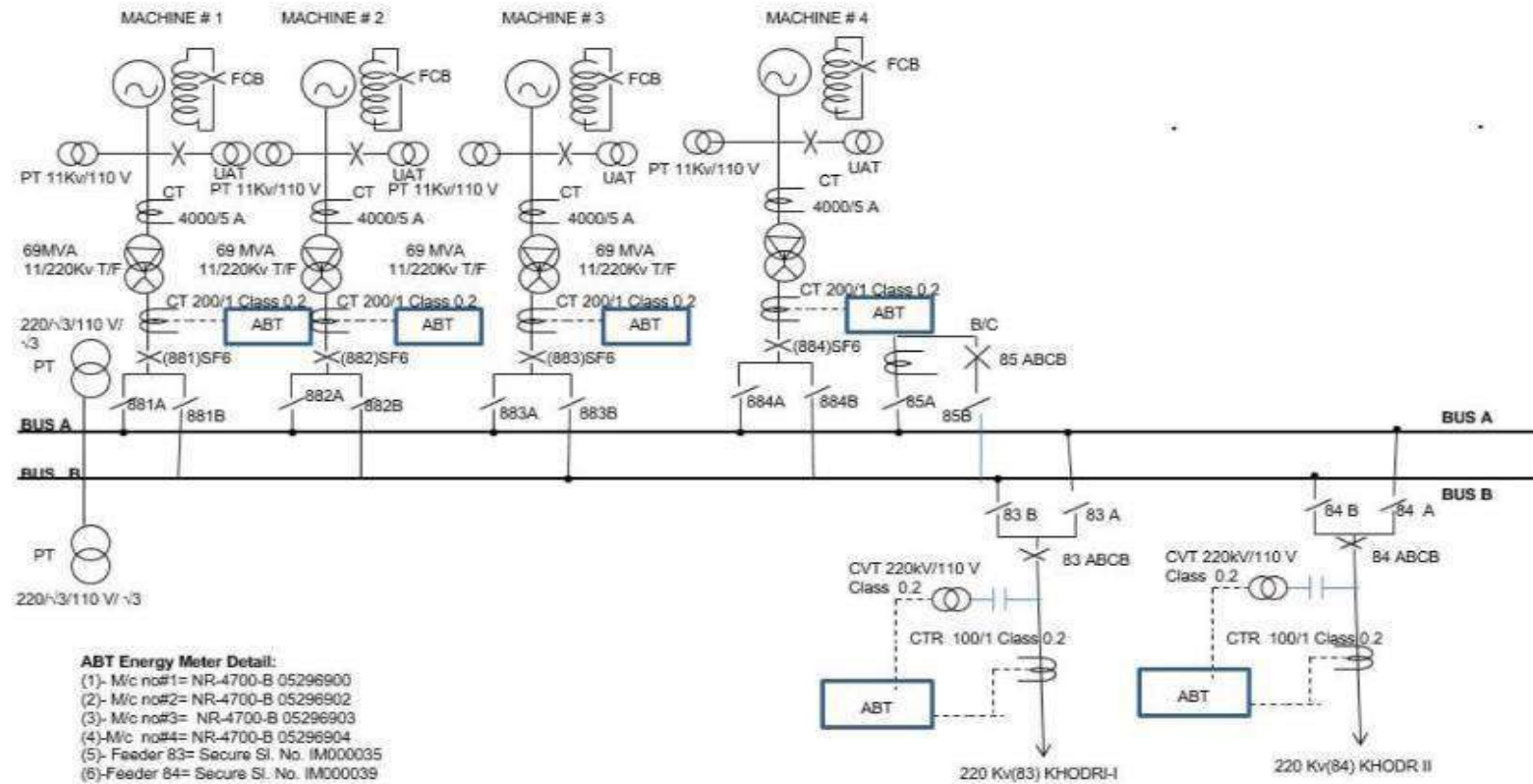

## 1.1: PROTECTION SYSTEM OVERALL REVIEW

220 kV SWITCHYARD CHIBRO POWER HOUSE, UJVNL		
DATE OF AUDIT BY CPRI TEAM : 11-10-2023		
Sl. No	Title	Details
1	Name Of Grid Substation	220 kV SWITCHYARD CHIBRO POWER HOUSE, UJVNL
2	Highest Voltage Level	220 kV
3	Year Of Installation	1975
4	No Of Feeders	Two 220 kV Feeder
5	No of Transformers, Make and Capacity	4*69 MVA, 220/11kV
6	Busbar Arrangement	Double Busbar Arrangement
7	Present Busbar Switching Status	Commissioned
8	Busbar Protection	Commissioned
9	Relay System Status	In Service
10	DC Supply System	[1] 220/110 V DC-I [2] 220/110 V DC-II [3] 50 V DC [4] 48 V DC-1 [5] 48 V DC-2
11	DC Supply Capacity And Adequacy	Battery is adequate for the station load.
12	DC System Earth Fault Status	Healthy condition.
13	GPS Receiver Make & Model	SANDS
14	GPS Clock Receiver & Synchronization Of Relay Status	Relays are synchronised
15	Common Event Logger Status	In-built feature in numerical relay is used
16	Line Disturbance Recorder	In-built feature in numerical relay is used
17	Fault Locator in Line	Provided
18	Breaker Failure Relay Status	Provided
19	Circuit Breaker test reports	Available
20	Relay test reports	Available
21	General Observation of Relay And Protection System	It is recommended that the all the Numerical Protection IEDs shall be tested once in 3 or 4 years as per the best practices.

### Protection audit teams at site:

#### UJVNL, Chibro Team Members:

- |   |                     |                                      |
|---|---------------------|--------------------------------------|
| 1 | Mr. Mr. Anup Deepak | Executive Engineer(Test), Dakpathar  |
| 2 | Mr. Anand Kumar     | Executive Engineer (Generation), CPS |
| 3 | Mr. Amit Ranjan     | Executive Engineer(MM&C)             |

4	Mr. Arvind Bahuguna	Asst. Engineer, M & FDR Protection
5	Mr. Ajai Kumar Singh	Asst. Engineer (Test)
6	Mr. Sudhir Kumar	Asst. Engineer (EM)
<b>CPRI Team Members:</b>		
1	Dr. J. Sreedevi	Joint Director, Hod
2	Mr. Ved Prakash Yadav	Engineering Officer

## 1.2: Relays Used for Transmission Line, Transformer, Reactor and Bus Bar Protection Substation

### 1.2.1: Relays used for Transmission Line Protection

Sl. No.	Name of the Feeder	Main-I	Main-II
1	Chibro - Khodri - I	ABB & REL511	ABB & REL521
2	Chibro - Khodri - II	ABB & REL511	ABB & REL521

### 1.2.2: Relays used for Transformer Protection:

Sl. No.	Transformer	Primary Protection	Back Up protection				
		Differential Protection	Inter Locked Over Current	UT over current	HV Standby Earth Fault	HV REF	LV REF
1	UNIT- 1	English Electric (CAG)	English Electric (CDG)	English Electric (SPEC)	English Electric (CDG)	English Electric (CAG)	English Electric (CAG)
2	UNIT- 2	English Electric (CAG)	English Electric (CDG)	English Electric (SPEC)	English Electric (CDG)	English Electric (CAG)	English Electric (CAG)
3	UNIT-3	English Electric (CAG)	English Electric (CDG)	English Electric (SPEC)	English Electric (CDG)	English Electric (CAG)	English Electric (CAG)
4	UNIT-4	English Electric (CAG)	English Electric (CDG)	English Electric (SPEC)	English Electric (CDG)	English Electric (CAG)	English Electric (CAG)

**1.2.3: Relays used for BUS BAR Protection:**

<b>Sl. No.</b>	<b>Voltage level</b>	<b>Make</b>	<b>Model</b>
1.	220kV	English Electrical	CAG

## 2.0 Input Data for Transmission Lines

### 2.1. Input Data for Transmission Lines Substation – Chibro - Khodri - I

Sl. No.	Description	Units	Value
	<b>Station Name</b>	<b>220 kV SWITCHYARD CHIBRO POWER HOUSE, UJVNL</b>	
<b>1</b>	<b>Line Reference</b>	<b>Chibro - Khodri - I</b>	
1.1	Line voltage level	kV	220
1.2	Name of remote substation		Chibro-1
<b>2</b>	<b>Main 1 Protection</b>		
2.1	Protection Type		Numerical
2.2	Model & Make		ABB REL 511
<b>3</b>	<b>Main 2 Protection</b>		
3.1	Protection Type		Numerical
3.2	Model & Make		ABB REL 521
<b>4</b>	<b>CT data for Main 1</b>		
4.1	Ratio	A/A	800/1
4.2	Class		PS
4.3	Vk / VA burden	Vk/VA	800/30
4.4	Rct	Ohms	5
4.5	Imag @ Vk	mA	30
<b>5</b>	<b>CT data for Main 2</b>		
5.1	Ratio		800/1
5.2	Class		PS
5.3	Vk / VA burden		800/30
5.4	Rct		5
5.5	Imag @ Vk		30
<b>6</b>	<b>PT Ratio</b>	kV/V	220kV/110V
<b>7</b>	<b>PROTECTED LINE DATA</b>		
7.1	Line Length	Km	5.77
7.2	Positive seq. RESISTANCE	Ohms/Km	0.0804
7.3	Positive seq. REACTANCE	Ohms/Km	0.41
7.4	Zero seq. RESISTANCE	Ohms/Km	0.2814
7.5	Zero seq. REACTANCE	Ohms/Km	1.435
<b>8</b>	<b>ADJACENT SHORTEST LINE DATA (from remote bus)</b>		
8.1	Name of the substation to which the shortest adjacent line is connected		<b>Chibro-II</b>
8.2	Line Length of shortest adjacent line	Km	8.59
8.3	Positive seq. RESISTANCE of shortest adjacent line	Ohms/Km	0.0804
8.4	Positive seq. REACTANCE of shortest adjacent line	Ohms/Km	0.41
8.5	Zero seq. RESISTANCE of shortest adjacent line	Ohms/Km	0.2814

8.6	Zero seq. REACTANCE of shortest adjacent line	Ohms/Km	1.435
9	<b>ADJACENT LONGEST LINE DATA (from remote bus)</b>		
9.1	Name of the substation to which the longest adjacent line is connected		<b>Khodri Station</b>
9.2	Line Length of longest adjacent line	Km	83.53
9.3	Positive seq. RESISTANCE of longest adjacent line	Ohms/Km	0.0804
9.4	Positive seq. REACTANCE of longest adjacent line	Ohms/Km	0.41
9.5	Zero seq. RESISTANCE of longest adjacent line	Ohms/Km	0.2814
9.6	Zero seq. REACTANCE of longest adjacent line	Ohms/Km	1.435
10	<b>Is there a transformer connected to the remote bus</b>	Yes/No	Yes
10.1	Number of Transformers		05
10.2	Voltage ratio of the Transformer	kV/kV	220/132
10.3	MVA of the transformers 1	MVA	1*100 MVA
			4*34 MVA
10.4	% Impedance of the transformers1	%	13.7



## 2.2. Input Data for Transmission Lines Substation – Chibro - Khodri - II

Sl. No.	Description	Units	Value
	<b>Station Name</b>	<b>220 kV SWITCHYARD CHIBRO POWER HOUSE, UJVNL</b>	
<b>1</b>	<b>Line Reference</b>	<b>Chibro - Khodri - II</b>	
1.1	Line voltage level	kV	220
1.2	Name of remote substation		Chibro-II
<b>2</b>	<b>Main 1 Protection</b>		
2.1	Protection Type		Numerical
2.2	Model & Make		ABB REL 511
<b>3</b>	<b>Main 2 Protection</b>		
3.1	Protection Type		Numerical
3.2	Model & Make		ABB REL 521
<b>4</b>	<b>CT data for Main 1</b>		
4.1	Ratio	A/A	800/1
4.2	Class		PS
4.3	Vk / VA burden	Vk/VA	800/30
4.4	Rct	Ohms	5
4.5	Imag @ Vk	mA	30
<b>5</b>	<b>CT data for Main 2</b>		
5.1	Ratio		800/1
5.2	Class		PS
5.3	Vk / VA burden		800/30
5.4	Rct		5
5.5	Imag @ Vk		30
<b>6</b>	<b>PT Ratio</b>	kV/V	220kV/110V
<b>7</b>	<b>PROTECTED LINE DATA</b>		
7.1	Line Length	Km	8.59
7.2	Positive seq. RESISTANCE	Ohms/Km	0.0804
7.3	Positive seq. REACTANCE	Ohms/Km	0.41
7.4	Zero seq. RESISTANCE	Ohms/Km	0.2814
7.5	Zero seq. REACTANCE	Ohms/Km	1.435
<b>8</b>	<b>ADJACENT SHORTEST LINE DATA (from remote bus)</b>		
8.1	Name of the substation to which the shortest adjacent line is connected		<b>220kV Chibro-Khodri II (84)</b>
8.2	Line Length of shortest adjacent line	Km	5.77
8.3	Positive seq. RESISTANCE of shortest adjacent line	Ohms/Km	0.0804
8.4	Positive seq. REACTANCE of shortest adjacent line	Ohms/Km	0.41
8.5	Zero seq. RESISTANCE of shortest adjacent line	Ohms/Km	0.2814
8.6	Zero seq. REACTANCE of	Ohms/Km	1.435

	shortest adjacent line		
9	<b>ADJACENT LONGEST LINE DATA (from remote bus)</b>		
9.1	Name of the substation to which the longest adjacent line is connected		<b>Chibro-I</b>
9.2	Line Length of longest adjacent line	Km	83.53
9.3	Positive seq. RESISTANCE of longest adjacent line	Ohms/Km	0.0804
9.4	Positive seq. REACTANCE of longest adjacent line	Ohms/Km	0.41
9.5	Zero seq. RESISTANCE of longest adjacent line	Ohms/Km	0.2814
9.6	Zero seq. REACTANCE of longest adjacent line	Ohms/Km	1.435
10	<b>Is there a transformer connected to the remote bus</b>	Yes/No	Yes
10.1	Number of Transformers		05
10.2	Voltage ratio of the Transformer	kV	220/132
10.3	MVA of the transformers 1	MVA	1*100 MVA
			4*34 MVA
10.4	% Impedance of the transformers1	%	13.7

### 3. Transmission line protective relay settings review:

Description	Existing Setting	Reviewed Setting	Existing setting	Reviewed setting
<b>Line Name</b>	<b>Khodri - Chibro-I</b>			
<b>Main I/II</b>	<b>Main-I</b>		<b>Main-II</b>	
<b>Relay</b>	<b>ABB REL 511</b>		<b>ABB REL 521</b>	
<b>ZONE 1</b>	Forward	Forward	Forward	Forward
R(Z1), Resistance for Ph-Ph faults	0.13	0.15	0.13	0.15
X(Z1), Reactance	0.76	0.76	0.76	0.76
RE(Z1), Resistance for ph-gnd	2.71	0.52	2.71	0.52
T1-1phase, delay for single phase	0	0	0	0
T1multi-ph, delay for multi-phase faults	0	0	0	0
<b>ZONE 2</b>	Forward	Forward	Forward	Forward
R(Z2), Resistance for Ph-Ph faults	0.69	0.22	0.69	0.22
X(Z2), Reactance	3.56	1.14	3.56	1.14
RE(Z2), Resistance for ph-gnd	2.08	0.78	2.08	0.78
T2-1phase, delay for single phase	0.4	0.35	0.4	0.35
T2multi-ph, delay for multi-phase	0.4	0.35	0.4	0.35
<b>ZONE 3</b>	Forward	Forward	Forward	Forward
R(Z3), Resistance for Ph-Ph faults	2.84	3.45	2.84	3.45
X(Z3), Reactance	14.56	17.57	14.56	17.57
RE(Z3), Resistance for ph-gnd	8.52	12.06	8.52	12.06
T3 delay	2	0.8	2	0.8
T3 Multi Phase	2	0.8	2	0.8
<b>Dead Line Detection</b>				
Operation	ON	ON	ON	ON
<b>Fuse Failure</b>				
Operation	ON	ON	ON	ON
<b>Power Swing Settings</b>				
Operation	ON	ON	ON	ON

Description	Existing Setting	Reviewed Setting	Existing setting	Reviewed setting
<b>Line Name</b>	<b>Khodri-Chibro-II</b>			
<b>Main I/II</b>	<b>Main-I</b>		<b>Main-II</b>	
<b>Relay</b>	<b>ABB REL 511</b>		<b>ABB REL 521</b>	
<b>ZONE 1</b>	Forward	Forward	Forward	Forward
R(Z1), Resistance for Ph-Ph faults	0.22	0.22	0.22	0.22
X(Z1), Reactance	1.22	1.13	1.12	1.13
RE(Z1), Resistance for ph-gnd	0.66	0.77	0.66	0.77
T1-1phase, delay for single phase	0	0	0	0
T1multi-ph, delay for multi-phase faults	0	0	0	0
<b>ZONE 2</b>	Forward	Forward	Forward	Forward
R(Z2), Resistance for Ph-Ph faults	0.78	0.33	0.33	0.33
X(Z2), Reactance	4.02	1.69	1.69	1.69
RE(Z2), Resistance for ph-gnd	2.35	1.16	0.99	1.16
T2-1phase, delay for single phase	0.4	0.35	0.6	0.35
T2multi-ph, delay for multi-phase	0.4	0.35	0.6	0.35
<b>ZONE 3</b>	Forward	Forward	Forward	Forward
R(Z3), Resistance for Ph-Ph faults	2.93	3.56	0.51	0.55
X(Z3), Reactance	15.02	18.13	2.63	2.83
RE(Z3), Resistance for ph-gnd	8.79	12.44	1.54	1.94
T3 delay	1.8	0.8	1.2	0.8
T3 Multi Phase	1.8	0.8	1.2	0.8
<b>Dead Line Detection</b>				
Operation	ON	ON	ON	ON
<b>Fuse Failure</b>				
Operation	ON	ON	ON	ON
<b>Power Swing Settings</b>				
Operation	ON	ON	ON	ON

#### 4.0 Input Data for Transformer Protection

Sl. No.	Description	Units	Value
1	<b>Transformer Name</b>		GT-Unit 1,2,3 & 4
1.1	<b>Ratings</b>		
1.2	MVA	MVA	200
2	Voltage Ratio	kV/kV	230/11
3	<b>Impedance</b>	%	13.7
4	<b>Vector Group</b>		YNd11
5	<b>NGR Data (if Present)</b>	Ohms	-
5.1	<b>OLTC Present</b>	Yes/No	No
5.2	OLTC Data		
5.3	Min Tap (%)	% (-)	-
5.4	Max Tap (%)	% (+)	-
6	No. of Steps		-
6.1	<b>Differential Protection provided</b>	Yes/No	Yes
6.2	Differential CT Ratio		
6.3	HV CT Ratio (Main & ICT)	A/A	800/1
7	LV CT Ratio (Main & ICT)	A/A	2090/19
7.1	<b>Differential Relay</b>		
7.2	Make		English Electric
8	Model		CAG

8.1	<b>HV REF provided</b>	Yes/No	Yes
8.2	REF Protection CTs Ratio ( <b>Main &amp; ICT</b> )	A/A	HV: 800/1 LV: NIL
8.3	Acc Class		-
8.4	RCT ( $\Omega$ )	Ohms	-
8.5	Vk(V)	V	>2000
8.6	Im@Vk/2	mA	-
8.7	Longest sec. one way lead R $\Omega$	Ohms	-
8.8	REF Relay		
8.9	Make		English Electric
8.10	Model		CAG
9	<b>LV REF provided</b>	Yes/No	Yes
9.1	REF Protection CTs Ratio ( <b>Main &amp; ICT</b> )	A/A	HV: 800/1 LV: NIL
9.2	Acc Class		PS
9.3	RCT ( $\Omega$ )	Ohms	
10	Vk(V)	V	>2000
10.1	Im@Vk/2	mA	-
10.2	Longest sec. one way lead R $\Omega$	Ohms	-
10.3	REF Relay		
10.4	Make		English Electric
10.5	Model		CAG
11	<b>Inter Locked Over Current</b>	Yes/No	Yes

11.1	Backup Over Current Protection Relay		
11.2	Make		English Electric
11.3	Model		CDG
11.4	Back-Up Over Current Protection CTs Ratio	A/A	-
<b>12</b>	<b>UT Over Current</b>	Yes/No	Yes
12.1	Backup Over Current Protection Relay		
12.2	Make		English Electric
12.3	Model		SPEC
12.4	Back-Up Over Current Protection CTs Ratio	A/A	-

#### 4.1 Transformers Protection Relay Setting Review

Sl. No.	Protection	Name		GT-Unit 1, 2, 3 & 4	
		Type of Relay Used		English Electric	
		Line Voltage (kV)		11/220	
		Capacity in MVA		69	
		Description		Existing Settings	Reviewed Settings
1	Transformer Differential	Operation		On	On
		Pick-Up Current	R	5	5
			Y	5	5
			B	5	5
2	HV Standby Earth Fault	Operation		On	On
		Pick-Up Current		0.4 A	0.4 A
3	HV REF Protection	Operation		On	On
		Pick-Up Current		0.05A	0.05A
4	LV REF Protection	Operation		On	On
		Pick-Up Current		0.5A	0.5A
5	Inter Locked Over Current	Operation		On	On
		Pick-Up Current	R	0.3A	0.3A
			Y	0.3A	0.3A
			B	0.3A	0.3A
6	UT Over Current	Operation		On	On
		Pick-Up Current	R	5A	5A
			Y	5A	5A
			B	5A	5A



## 5 DC Measurements

DC battery and chargers are very important units as they are required to operate the protection relays. In this section, the details of the batteries and chargers are provided.

Following is the measurement of DC source which was taken during the site visit:

### A. DC Supply

		<b>Positive to Negative</b>	<b>Positive to Earth</b>	<b>Negative To Earth</b>
1	DC Bank 1	232.50	+130.10	-102.10

**6 Study results of field inspection of existing protection devices for obsolescence of technology, suitability, healthiness**

Sl. No.	Protection	Suggested Numerical IEDs:
1	Transformer Differential	MiCOM P643, P645, Siemens 7UT612, 7UT613, ABB RET 670, SEL 787, ZIV 8IDB, 8IDV etc.
2	Restricted Earth Fault	MiCom P645, P141, Siemens 7SJ802, 7UT613, ABB RET 670, REL 670 etc.
3	Transformer Backup	MiCOM P645, P141, Siemens 7SJ804, 7SA611, ABB REF 615, ERL CSC 211, ZIV 7IRV, GE F650 etc.
4	Busbar Protection	MiCOM P740, ABB REF615, Siemens SIPROTEC 7SJ85, GE Multilin P40, Eaton Multilin P145 etc.

The installed relays for above mentioned protection is Electro-mechanical type and very old & obsolete. These protections may be replaced with any one of the latest numerical protection IEDs suggestions given in the table.

## 7 Protection Review and Recommendations:

In general, protection schemes and setting are in order. All the 220 kV lines, Transformers are protected through numerical based Protection schemes.

1. The distance protection Main I & Main II, Zone 1 impedance reach setting for Chibro-Khodri I are properly set and some revisions are required in Zone 2 & Zone 3 impedance reach settings.
2. The distance protection Main-I & II of Zone 1 impedance reach setting for Chibro-Khodri II lines are properly set and some revisions are required in Zone 2 & Zone 3 impedance reach settings.
3. The earth fault protection is also protected to all line protection. Power swing, CB fail, and broken conductor is also provided on all lines. Minor changes in Power swing.
4. Resistive reach for Ph-Ph & Ph-Gnd to be reviewed for all the Lines. Since, For the calculation of resistive reach (Ph-Ph & Ph-Gnd), CPRI considered the Arc Resistance and Tower footing resistance as 28.864  $\Omega$  & 10  $\Omega$  respectively. If the Arc Resistance and Tower footing resistance values are different at the substation based on local substation condition, then all resistive reach (Ph-Ph & Ph-Gnd) same setting may be retained.
5. Other Protection functionality for lines like broken conductor Voltage supervision and Carrier communication are working satisfactory.
6. The differential protection setting for transformers are properly set and stable.
7. The differential protection setting for busbar are properly set and stable.
8. Relay coordination has been reviewed and found satisfactory.
9. It is suggested to perform the third-party protection audit of substation/generating station periodically.

**Note:** Difference observed between existing settings and reviewed settings are given in bold font in respective protection.

## **8 Review of reports**

### **Review of test reports of CTs & CVTs:**

Pre-commissioning test reports were provided for all relays and CTs & CVT and these were reviewed. It is recommended that pre-commissioning reports of all relays, CTs and CVTs should be kept properly and they should be mandatorily provided whenever they are required to be reviewed. It is also recommended that routine testing of all relays should be carried out regularly in future.

### **Review of test reports of Circuit Breaker:**

Test reports of all Circuit Breakers were provided and reviewed. It is recommended that pre-commissioning reports of all circuit breakers should be kept properly and they should be mandatorily being provided whenever they are required to be reviewed. It is also recommended that routine testing of all circuit breakers should be carried out regularly in future.

# **CONSULTANCY REPORT**

## **Protection audit of 220kV Substation at 240 MW Chibro Power House VOLUME-I**

**Clients Reference: PO NO: 5300000132  
CPRI Reference: No. 2/9/PSD/UJVNL/2022-23  
CPRI Report: No. 2/9/PSD/RT99/2023**

**CUSTOMER**  
**M/s UJVNL, Dehradun**

### **CONSULTANT**



**POWER SYSTEMS DIVISION  
CENTRAL POWER RESEARCH INSTITUTE**

**Sir. C.V.RAMAN ROAD, P.B. NO. 8066  
SADASHIVANAGAR P.O  
BANGALORE – 560 080.**

**Website : <http://www.cpri.res.in>**

**November 2023**

# CT

Sl. no	Location	CT ratio	Make and model	CT serial no	Date of commissioning	Date of last testing	Serviceable/ Non Serviceable	Remarks
1	UNIT 1	200-100/1	ABB	2109556	2009	2022	Serviceable	The life span of CT is 25 years. Test reports show that Tan delta and accuracy are well within limit. The performance of CT is satisfactory
				2109558	2009	2022		
				2109557	2009	2022		
2	UNIT 2	200-100/1	ABB	2109551	2009	23.12.2022	Serviceable	
				2109554	2009	23.12.2022		
				2109561	2009	23.12.2022		
3	UNIT 3	200-100/1	ABB	2109553	2009	2022	Serviceable	
				2109560	2009	2022		
				2109562	2009	2022		
4	UNIT 4	200-100/1	ABB	2109555	2009	2022	Serviceable	
				2109552	2009	2022		
				2109559	2009	2022		
5	Feeder 83	800/1	ABB	46885	10/12/2015	10/12/2015	Serviceable	
				46886	10/12/2015	10/12/2015		
				46882	10/12/2015	10/12/2015		
6	Feeder 84	800/1	ABB	46881	22/01/2016	22/01/2016	Serviceable	
				46883	22/01/2016	22/01/2016		
				46884	22/01/2016	22/01/2016		
7	BUS COUPLER	800/1	ABB	46879	2016	2016	Serviceable	
				46880	2016	2016		
				46878	2016	2016		

# PT

Sl. no	Location	PT ratio	Make and model	PT serial no	Date of commissioning	Date of last testing	Serviceable/ Non Serviceable in case of Breakdown	Remarks
1	Chibro Switch Yard	220kV/110V	-	2243704 / 2 CORE	21/01/2016	21/01/2016	Serviceable	PTs commissioned in the year 2016 and all the tests were conducted during commissioning. Performance of the PTs is satisfactory.
				2243707 / 2 CORE	21/01/2016	21/01/2016		
				2243699 / 2 CORE	21/01/2016	21/01/2016		
2	Chibro Switch Yard		-	740373	-	-	Serviceable	
				740375	-	-		
				740374	-	-		

## CVT

Sl. no	Location	CVT ratio	Make and model	CVT serial no	Date of commissioning	Date of last testing	serviceable/ Non serviceable	Remarks
1	Feeder 83	220kV/ 110 V	-	S-46874	15/01/2016	15/01/2016	serviceable	CVTs commissioned in the year 2016 and all the tests were conducted during commissioning. Performance of the CVTs is satisfactory.
				S-46873	15/01/2016	15/01/2016		
				S-46871	15/01/2016	15/01/2016		
2	Feeder 84	220kV/ 110 V	-	S-46870	1/25/2016	1/25/2016	serviceable	
				S-46869	1/25/2016	1/25/2016		
				S-46872	1/25/2016	1/25/2016		



# CIRCUIT BREAKER

Sl. no	Location	Make and Model	Serial Number	Status of Breaker available or not	Number of Trip/close coil and healthiness	Date of commissioning	Date of Last timing taken	Operating time (ms)	Serviceable/ Non serviceable	Remarks
<b>A</b>	<b>220 kV System</b>									
1	220 kV Bay 1	ABB/PAS S MOS (Feeder)	245S034	YES	Healthy	2019	2019	19	serviceable	CBs commissioned in the year 2019 and all the tests were conducted during commissioning. Performance of the CBs is satisfactory.
2	220 kV Bay 2	ABB/PAS S MOS (Feeder)	245S035	YES	Healthy	2019	2019	19.8	serviceable	
3	220 kV Bay 3	ABB/PAS S MOS (B/C)	245S036	YES	Healthy	2019	2019	20.2	serviceable	
4	220 kV Bay 4	CGL/200-SFM-40A (UNIT-1)	16471 C	YES	Healthy	2003	28/03/2023	21	serviceable	The opening time is well within the limit and performance of CB is satisfactory.
5	220 kV Bay 5	CGL/200-SFM-40A (UNIT-2)	16472 C	YES	Healthy	2003	25/03/2023	23	serviceable	
6	220 kV Bay 6	CGL/200-SFM-40A (UNIT-3)	16473 C	YES	Healthy	2003	28/03/2023	22	serviceable	
7	220 kV Bay 7	CGL/200-SFM-40A (UNIT-4)	16474 C	YES	Healthy	2003	28/03/2023	22	serviceable	

## DC Supply

Sl. no	Name	Date of Commission	Last testing	Remarks
1	220V DC-1	5/5/2011	Testing has been performed weekly.	The Performance of battery is satisfactory. It is suggested to extend the both 220V DC source to the switchyard for breaker operation.
2	220V DC-2	21/03/2019		
3	50 V DC	25/10/2016		
4	48 V DC-1	5/5/2011		
5	48 V DC-2	20/07/2021		

## Transmission Line Protection

Sl. no	Voltage	Name of Protection Line		Make & Model	Serial No	Functional	Date of last testing	Date of Commissioning	Serviceable/ Non serviceable	Remarks
1	220kV	Chibro - Khodri 1 (83)	MAIN 1	ABB & REL511-1N3	T0503157	YES	Not tested	08.02.2006	Serviceable	Since the available protection relay has no provision for communication and time sync facility. It is suggested to replace with the latest numerical IEDs.
2		Chibro - Khodri 2 (84)		ABB & REL511-1N3	T0507009	YES	Not tested	03.03.2006	Serviceable	

Sl. no	Voltage	Name of Protection Line		Make & Model	Serial No	Functional	Date of last testing	Date of Commissioning	Serviceable/ Non serviceable	Remarks
1	220kV	Chibro - Khodri 1 (83)	MAIN 2	ABB & REL521-1N3	T0449073	YES	Not tested	2005-2006	Serviceable	Since the available protection relay has no provision for communication and time sync facility. It is suggested to replace with the latest numerical IEDs.
2		Chibro - Khodri 2 (84)		ABB & REL521-1N3	T0449076	YES	10/5/2010	2005-2006	Serviceable	

Sl. no	Voltage	Name of Protection Line		Make & Model	Serial No	Functional	Date of last testing	Date of Commissioning	Serviceable/ Non serviceable	Remarks
1	220kV	Chibro - Khodri 1 (83)	LBB	Schneider P127	39803979	YES	22/05/2023	22/05/2023	Serviceable	The available protection is latest numerical IED. Performance is satisfactory.
2	220kV	Chibro - Khodri 2 (84)	LBB	Schneider P127	39820190	YES	22/05/2023	22/05/2023	Serviceable	

# Transformer Protection

Sl. no	Transformer (ICT/GT/ST)	TYPE	Make	Model Number	Serial No	Functional	Date of Testing	Date of Commissioning	OTI/WTI Indicator	Bucholtz/PDR	Remarks
1	GT - 1,2,3,4	Differential	BHEL	-	3371881 3371880 3371879	YES	NOT TESTED	1975	YES	M118302 (GT1)	The available protection is electro-mechanical type and very old & trouble prone. This needs to be upgraded with the latest numerical IED.
		Inter locked over current		CDG31981 31CV	-	YES		1975		M118300 (GT2)	
		UT - Over Current		SPECMIEG 250H	-	YES		1975		M118301 (GT3)	
		HV standby Earth Fault		CDGIIAF2 28A5	-	YES		1975		M115016 (GT4)	
		HV REF		CAG14AF2 5A	-	YES		1975		-	
		LV REF		CAG14AF1 5A	-	YES		1975		-	

Sl. no	Transformer	Vector Group	MVA capacity in MVA	Percentage Impedance	Rated kV in kV		CT ratio			Remarks
					HV	LV	HV	LV	NCT	
1	GT-1	Yd11	69	13.7	230	11	800/1	2090/19	200/1	The data is used for the relay setting calculation and review.
2	GT-2	Yd11	69	13.7	230	11	800/1	2090/19	200/1	
3	GT-3	Yd11	69	13.7	230	11	800/1	2090/19	200/1	
4	GT-4	Yd11	69	13.7	230	11	800/1	2090/19	200/1	

## Bus bar Protection

Sl no	Bus bar	Make and model	Serial number	Date of last tested	Date of Commissioning	Serviceable/ Non Serviceable	Stability check	Remarks
1	220	EE & CAG34AAF75A (B phase)	M118305, M118304, M118303	Not Tested	23/05/2023	Non Serviceable		The available protection is electro-mechanical type and very old & trouble prone. This needs to be upgraded with the latest numerical IED.

## Auxiliary Systems

Sl. no	Auxiliary supply	Sources of Supply	Reliability of Supply	Average of Tripping Month	Remarks
1	33 kV Supply 1	Dhakrani substation	-	10	Performance is satisfactory.
2	33 kV Supply 2	Dhakrani substation	-	12	

Sl. no	DG set	Make and model	Serial Number	Rating	set Auto/Manual	Fuel Level	Date of last testing	Date of Commissioning	Serviceable/ Non Serviceable	Remarks
1	DG 1	Kirloskar	2516	500kVA	Manual	above 70%	23/08/2023	31/03/2017	Serviceable	Performance is satisfactory.
2	DG 2	Kirloskar	41K157	500kVA	Manual	above 90 %	23/08/2023	31/03/2021	Serviceable	

## SUMMARY & RECOMMENDATION

### Protection audit of 220kV Substation at 240 MW Chibro Power House

<b>1</b>	<b>DC Supply</b>	The Performance of battery is satisfactory. It is suggested to extend the both 220V DC source to the switchyard for breaker operation.
<b>2</b>	<b>220kV Chibro-Khodri 1 &amp; Chibro- Khodri 2 (MAIN 1)</b>	Since the available distance protection relay has no provision for communication and time synchronization facility. It is recommended to replace with the latest numerical IEDs.
<b>3</b>	<b>220kV Chibro-Khodri 1 &amp; Chibro- Khodri 2 (MAIN 2 )</b>	Since the available distance protection relay has no provision for communication and time synchronization facility. It is recommended to replace with the latest numerical IEDs.
<b>4</b>	<b>GT- 1,2,3,4</b>	<ul style="list-style-type: none"> <li>❖ The available protections are electro-mechanical type and very old &amp; trouble prone. It is recommended to replace with the latest numerical IEDs.</li> <li>❖ Generator Transformer Protection: <ul style="list-style-type: none"> <li>➤ HV standby earth fault relay 64GTS</li> <li>➤ HV &amp; LV restricted earth fault relay 64GTR, 64UTR</li> <li>➤ Overall differential relay 87GT</li> </ul> </li> </ul>
<b>5</b>	<b>220 kV Bus bar</b>	<p>The available protections are electro-mechanical type and very old &amp; trouble prone. The following relays needs to be upgraded with the latest numerical IEDs</p> <ul style="list-style-type: none"> <li>❖ Bus Bar Protection <ul style="list-style-type: none"> <li>➤ Bus bar super vison relay type VTX 95A, 95B, 95CH;</li> <li>➤ Differential Protection 87A, 87B, 87CH,</li> <li>➤ Auxiliary relays 95AX, 95BX, 95CHX</li> <li>➤ Trip circuit supervision relays 95AY, 95BY, 95CHY</li> <li>➤ Interlock over current relay 51B1</li> <li>➤ Tripping Relay: 13 No. (96A, 96B, 96C to 96H)</li> </ul> </li> </ul>

		<ul style="list-style-type: none"> <li>❖ Synchronizing relay need to be installed.</li> <li>❖ Bay control Unit is not available in the substation and need to be installed.</li> </ul>
<b>6</b>	<b>Khodri – Chibro line</b>	It is recommended that the PLCC on Khodri - Chibro lines for tandem operation of generators which was commissioned in 2005-06 is obsolete and spares are not available. It is very much important to have a healthy PLCC communication for tandem operation and needs to be replaced.
<b>7</b>	<b>Testing</b>	It is recommended that all the CT, CVT, PT,CB and Numerical Protection IEDs shall be tested once in 3/4/5 years.





यूजेवीएन लिमिटेड  
(उत्तराखण्ड सरकार का उपक्रम)

**UJVN LIMITED**

**(A Govt. of Uttarakhand Enterprise)**

कार्यालय: उप महाप्रबन्धक (सोलर, सामग्री प्रबन्धन एवं अनुबन्ध) गंगाभवन, यमुनाकालोनी, देहरादून-248001 दूरभाष-0135-2531762 फ़ैक्ससं० 0135-2531762  
Office of the Dy. General Manager (SOLAR, MM&CM), Ganga Bhawan, Yamuna Colony, Dehradun-248001 Phone-0135-2531762, Fax -0135-2531762

CIN No. U40101UR2001SGC025866

ISO 9001:2015, 14001 :2015, 45001 :2018 Certified

---

**Dy. General Manager (HGC)**  
**UJVN Ltd., Dakpathar.**

**Subject :-** A Report on Protection Audit conducted by CPRI.

Please find enclosed herewith the report on protection audit conducted by CPRI Bangalore with respect to Khodri Power House, Dakpathar.

It is requested to provide comments on the above report and accordingly review the requirement of switchyard equipments etc. under PSDF scheme of GoI.

**(S.K.Baunsiyal)**  
**Dy. General Manager**

**Cc.**

1. ED(O&M) UJVN Ltd., "Ujjwal" GMS Road, Dehradun for kind information.
2. EE(IC&CM) UJVN Ltd. Dehradun in reference to his letter no . 52147 UJVN-D(P)0EDEM(EEIC)/4/2024-e-Office-UJVN Limited Dated 04/01/2024.

I/53062/2024

पंजीकृतकार्यालय: "उज्जवल", महारानीबाग, जी०एम०एस० रोड, देहरादून-248006 (उत्तराखण्ड), दूरभाष: 0135-2763808, फ़ैक्स: 0315-2763508  
Regd. Office: "UJJWAL", Maharani Bagh, G.M.S. Road, Dehradun - 248006 (Uttarakhand), Phone: 0135-2763808, Fax: 0135-2763508 Website: www.ujvnl.com



यूजेवीएन लिमिटेड  
(उत्तराखण्ड सरकार का उपक्रम)  
**UJVN LIMITED**  
(A Govt. of Uttarakhand Enterprise)

कार्यालय: अधिशासी अभियन्ता(आईसीएण्ड सीएम), गंगाभवन, यमुनाकालोनी, देहरादून-248001 दूरभाष-0135-2531762 फ़ैक्स-0135-2531762  
Office of the Executive Engineer (IC&CM), Ganga Bhawan, Yamuna Colony, Dehradun-248001 Phone-0135-2531762, Fax -0135-2531762  
CIN No. U40101UR2001SGC025866

ISO 9001:2008 Certified

**Executive Engineer (Gen/Test)**  
**UJVN Ltd. Khodri Power**  
**House, Dakhpathar.**

**Sub: - Draft report of CPRI Audit.**

Please find herewith the attached document of draft Protection Audit report of CPRI for Khodri Power House Substation. It is request to provide your valuable comments/Suggestion at earliest. So that CPRI may submit their final Protection Audit Report.

**Amit Ranjan**  
**Executive Engineer**

**Copy:- Forwarded for kind information and necessary action.**

1. DGM (Solar, MM&CM) Ganga Bhawan Yamuna Colony, Dehradun.
2. DGM Khodri Power House Dakhpathar.

# **CONSULTANCY REPORT**

## **Protection audit of 220kV Substation at 120MW Khodri Power House VOLUME-II**

**Clients Reference: PO NO: 5300000132  
CPRI Reference: No. 2/9/PSD/UJVNL/2022-23  
CPRI Report: No. 2/9/PSD/RT99/2023**

**CUSTOMER**  
**M/s UJVNL, Dehradun**

### **CONSULTANT**



**POWER SYSTEMS DIVISION  
CENTRAL POWER RESEARCH INSTITUTE  
Sir. C.V.RAMAN ROAD, P.B. NO. 8066  
SADASHIVANAGAR P.O  
BANGALORE – 560 080.  
Website : <http://www.cpri.res.in>  
November 2023**



**POWER SYSTEMS DIVISION**  
**CENTRAL POWER RESEARCH INSTITUTE**  
**Sir. C.V. RAMAN ROAD P.B.No.8066, BANGALORE 560080**  
Website: <https://cpri.res.in>

Ref. File No.: 2/9/PSD/UJVNL/2022-23

Dated.07-12-2023

<b>Title</b>	<b>Third Party Protection audit at for 220kV Substation at 120MW Khodri Power House</b>
Project Objectives	Review Of Protection Scheme, Relay Settings Of Various Element & Associated System Of for 220kV Substation at 120MW Khodri Power House
Name and Address of the Customer	M/S UJVNL, Dehradun
Client's Reference and Date	5300000132 Date :10.10.2023
CPRI report No:	2/9/PSD/RT99/2023
Name(s) of investigator(s) from CPRI	1. Dr J Sreedevi ,Joint Director & HOD 2. Mr. .Ved Prakash Yadav, Engineering Officer
Name of UJVNL, Dehradun officers, associated in providing support to CPRI	1.Mr. Anup Deepak, Executive Engineer(test), Dakpathar 2.Mr. Mandeep Singh, Executive Engineer (Generation), KPS 3.Mr. Amit Ranjan, Executive Engineer(MM&C) 4. Mr. Arvind Bahuguna, Asst Engineer, M&FDR Prtn 5. Vedpal Arya, Asst Engineer (test) 6. Sharad Raghuvanshi, Asst Engineer (EM)
Report contains	Number of pages : 49
Report Reviewed by:  Mr.Ved Prakash Yadav Engineering Officer Power Systems Division, CPRI  Signature:	Report Approved by:  Dr. J. Sreedevi Joint Director & HoD Power Systems Division, CPRI  Signature:

## **ACKNOWLEDGEMENT**

CPRI wishes to thank UJVNL, Dehradun , for awarding the contract of Third Party Protection audit of *220kV Substation at 120MW Khodri Power House* PO No. 2/9/PSD/UJVNL/2022-23to CPRI. CPRI wishes to thank all the Officers/Engineers of UJVNL Dehradun, who were associated in this work for their co-operation in providing the required data and for their interaction during the visit to the substation. CPRI Team specially thank the following personnel for their excellent co-operation without which this work would not have been possible,

1. Mr. Shri Anup Deepak, Executive Engineer(test), Dakpather
2. Mr.Mandeep Singh, Executive Engineer (Generation), KPS
3. Mr. Amit Ranjan, Executive Engineer(MM&C)
4. Mr. Arvind Bahuguna, Asst Engineer, M&FDR Prtn
5. Mr. Vedpal Arya, Asst Engineer (test)
6. Mr. Sharad Raghuvanshi, Asst Engineer (EM)



## Minutes of Meeting

MOM Between	Date
CPRI, Bangalore & M/s UJVNL	10/10/2023

### 1. Participants:

Organization	Name
CPRI, Bangalore	Dr J.Sreedevi, Joint Director Shri Ved Prakash Yadav, Engineering Officer
UJVNL	Shri Anup Deepak, Executive Engineer(test), Dakpather Shri Mandeep Singh, Executive Engineer (Generation), KPS Shri Amit Ranjan, Executive Engineer(MM&C) Shri Arvind Bahuguna, Asst Engineer, M&FDR Prtn Shri Vedpal Arya, Asst Engineer (test) Shri Sharad Raghuvanshi, Asst Engineer (EM)

### 2. Meeting Details:

Subject:	Visit for Protection Audit of M/s UJVNL Khodri & Chibro Power House
Reference:	PO. No. 5300000132 dated: 11/08/2022

### 3. Notes of Meeting:

- CPRI officials visited Khodri substation on 10/10/2023 and briefed about the protection audit of the M/s UJVNL, Khodri Power House Switchyard.
  - During the protection audit work, the existing setting of Numerical protection IEDs of all lines were downloaded and taken for setting calculations
  - It is observed that following protections are Electro-mechanical type which needs to be replaced/added with the latest numerical relays (IEDs) :
    - Bus bar protection:
      - Bus bar super vision relay type VTX 95A, 95B, 95CH;
      - Differential Protection 87A, 87B, 87CH,
      - Auxiliary relays 95AX, 95BX, 95CHX
      - Trip circuit supervision relays 95AY, 95BY, 95CHY
      - Interlock over current relay 51B1
      - Tripping Relay : 13 No.( 96A, 96B, 96C to 96H)
- For the fault on 11.09.2022, the unit 3, R-phase CB bursted but Bus bar protection not operated, the breaker of far end got tripped. So it was found that bus bar protection is not healthy and tried to Rectify with OEM and found that spares are not available.
- Synchronizing relay
  - Bay control Unit is not available in the substation
- It is also found that, the 132kV line side, breaker is not available and hence for any fault at 132kV side, the network of 33kV is getting isolated and solar power integrated at 33kV is not possible to evacuate resulting in generation loss. Also, in case of fault, shutdown and



maintenance, the breaker operation is being done from remote end, hence 132kV breaker is recommended.

- It is observed that SANDS make time synchronization unit is available for 220 kV system but all the available IEDs are not time synchronized due to lack of time sync provision in few relays such as ABB REL511 & ABB REL521.
- CPRI Officers went around 220kV and 132kV Switchyard to check the maintenance of the substation and measured the DC voltage (lead acid) in CB panel as below. It is found that high impedance earth fault persists which needs to be attended and rectify.

	Positive to Negative	Positive to Earth	Negative to Earth
DC Bank 1	237.60	+152.40	-84.60

- It is observed that two DC sources are available but only one source is extended to the switchyard. This needs to be attended at the earliest.
- It is observed that the oil leakage is present in the 100 MVA 220/132 kV transformer in switchyard and this needs to be attended at the earliest.
- It is observed that the PLCC on Khodri - Chibro lines for tandem operation of generators which was commissioned in 2005-06 is obsolete and spares are not available. It is very much important to have a healthy PLCC communication for tandem operation and needs to be replaced.
- It is observed that the routine testing of CT, CVT, Numerical Protection IEDs and CBs have been done periodically. The test report of CTs, CVTs, Numerical protection IEDs and CBs are available for 220 & 132 kV system and reviewed.
- It is recommended that the all the Numerical Protection IEDs shall be tested once in 3/4/5 years as per the best practices adopted by the other organization such as PGCIL etc.
- It is recommended that the testing equipment such as tan delta kit, secondary injection kit, leakage current tester, power analyzer, winding resistance, TTR meter, energy meter testing is required at Khodri power house site for periodic testing and fault analysis. The same may be utilized at Chibro & Dhakpathar Power houses.
- It is recommended that Relay Test System and other testing equipment must be calibrated from NABL Accredited Laboratory & the calibration must include voltage, current, frequency, phase angle, power and time. The calibration point shall be decided as per the setting of Numerical Protection IEDs.
- Switchyard of 220 & 132 kV Khodri switchyard is being maintained properly and it is neat and clean.

The CPRI audit team thanked to the personnel of Khodri power house arranging the protection audit.

For CPRI

*J. Sreejith*  
10/10/23

For UJVNL

*Amit*  
10-10-23



# 1. Executive Summary

Power Systems Division of Central Power Research Institute conducted the third party protection audit of 220kV Substation at 120MW Khodri Power House as per the PO No. 2/9/PSD/UJVNL/2022-23 Dated 10/10/2023. The different protection that were covered under the audit are (i) Distance Protection (ii) ICT Protection and (iii) Bus bar Protection. It also included the checking of (i) DC Supply (ii) AC Supply with DG (iii) Communication system with DR (iv) Circuit Breaker (v) CT and (vi) CVT (vii) Synchro-Check. The audit format was provided by CPRI and the respective data was filled by the substation officers.

This report pertains to the audit carried out for **220kV Substation at 120MW Khodri Power House**. The protection audit of the substation was carried out from 04/09/2023 to 07/09/2023. UJVNL, DEHRADUN have (a) Seven 220 kV transmission lines (b) One 132 kV transmission lines (c) Four ICT's After viewing the downloaded settings at substation for lines, transformer and busbar most of the settings are found to be in line with the recommended settings as per guidelines. However, some of the deviations found are given below:

1. The distance protection Main-I & II of all Zone impedance reach setting for Khodri - Chibro-I lines are properly set.
2. The distance protection Main-I & II of all Zone impedance reach setting for Khodri - Chibro-II lines are properly set.
3. The distance protection Main-I of all Zone impedance reach setting for Khodri-Sarsawa , Khodri-Saharanpur II , Khodri-Jhajhra & Khodri-Mazri I lines are properly set.
4. The distance protection Main-II, Zone 1 & Zone 3 impedance reach setting for Khodri-Sarsawa are properly set and some minor revisions are required in Zone 2 impedance reach settings.
5. The distance protection Main-II, Zone 1 impedance reach setting for Khodri-Saharanpur II are properly set and some minor revisions are required in Zone 2 & Zone 3 impedance reach settings.
6. The distance protection Main-II, Zone 1 impedance reach setting for Khodri-Mazri I properly set and some minor revisions are required in Zone 2 & Zone 3 impedance reach settings.
7. Some revisions are required in Zone 1, Zone 2 & Zone 3 impedance reach settings for Khodri-Mazri II.
8. The distance protection Main-I Zone 1 & Zone 2 impedance reach setting for Khodri-Dhakrani are properly set and some minor revisions are required in Zone 3 impedance reach settings. the available protection is electromechanical type. This needs to be upgraded with the latest numerical IED.

9. The earth fault protection is also protected to all line protection. Power swing, CB fail, and broken conductor is also provided on all lines. Minor changes in Power swing.
10. Resistive reach for Ph-Ph & Ph-Gnd may be reviewed for all the Lines. Since, For the calculation of resistive reach (Ph-Ph & Ph-Gnd), CPRI considered the Arc Resistance and Tower footing resistance as 28.864  $\Omega$  & 10  $\Omega$  respectively. If the Arc Resistance and Tower footing resistance values are different at the substation based on local substation condition, then all resistive reach (Ph-Ph & Ph-Gnd) same setting may be retained.
11. Other Protection functionality for lines like broken conductor Voltage supervision and Carrier communication are working satisfactory.
12. The differential protection setting for transformers are properly set and stable.
13. The differential protection setting for busbar are properly set and stable.
14. Relay coordination has been reviewed and some minor variation is required for few settings. The same has been provided in relay coordination sheet.
15. It is suggested to perform the third-party protection audit of substation/generating station periodically.

## CONTENTS

<b>220 kV SWITCHYARD KHODRI POWER STATION UJVNL</b>		
<b>Sl. No.</b>	<b>Description</b>	<b>Page No</b>
1.0	LINE DIAGRAM OF 400 KV SUBSTATION NTPC VINDHYACHAL	1
1.1	PROTECTION SYSTEM OVERALL REVIEW	2
1.2	RELAYS USED FOR TRANSMISSION LINE, TRANSFORMER, REACTOR AND BUS BAR PROTECTION SUBSTATION	4
1.2.1	RELAYS USED FOR TRANSMISSION LINE PROTECTION	4
1.2.2	RELAYS USED FOR TRANSFORMER PROTECTION	6
1.2.3	RELAYS USED FOR BUSBAR PROTECTION	7
2.0	INPUT DATA FOR TRANSMISSION LINES	7
2.1	INPUT DATA FOR TRANSMISSION LINES SUBSTATION KHODRI - CHIBRO 1	8
2.2	INPUT DATA FOR TRANSMISSION LINES SUBSTATION KHODRI - CHIBRO 2	10
2.3	INPUT DATA FOR TRANSMISSION LINES SUBSTATION KHODRI - SARSAWA	12
2.4	INPUT DATA FOR TRANSMISSION LINES SUBSTATION KHODRI – SAHARANPUR-2	14
2.5	INPUT DATA FOR TRANSMISSION LINES SUBSTATION KHODRI - JHAJHRA	16
2.6	INPUT DATA FOR TRANSMISSION LINES SUBSTATION KHODRI – MAZRI-1	18
2.7	INPUT DATA FOR TRANSMISSION LINES SUBSTATION KHODRI – MAZRI-2	20
2.8	INPUT DATA FOR TRANSMISSION LINES SUBSTATION KHODRI - DHAKRANI	22
3.0	TRANSMISSION LINE PROTECTIVE RELAY SETTINGS REVIEW	24
4.0	INPUT DATA FOR TRANSFORMER PROTECTION	38
4.1	TRANSFORMERS PROTECTION RELAY SETTING REVIEW	41
5.0	DC MEASUREMENTS	43
6.0	PROTECTION REVIEW AND RECOMMENDATIONS	45
7.0	REVIEW OF TEST REPORTS	47

1.0: LINE DIAGRAM OF 220kV KHODRI POWER STATION (4X27.9 MW).

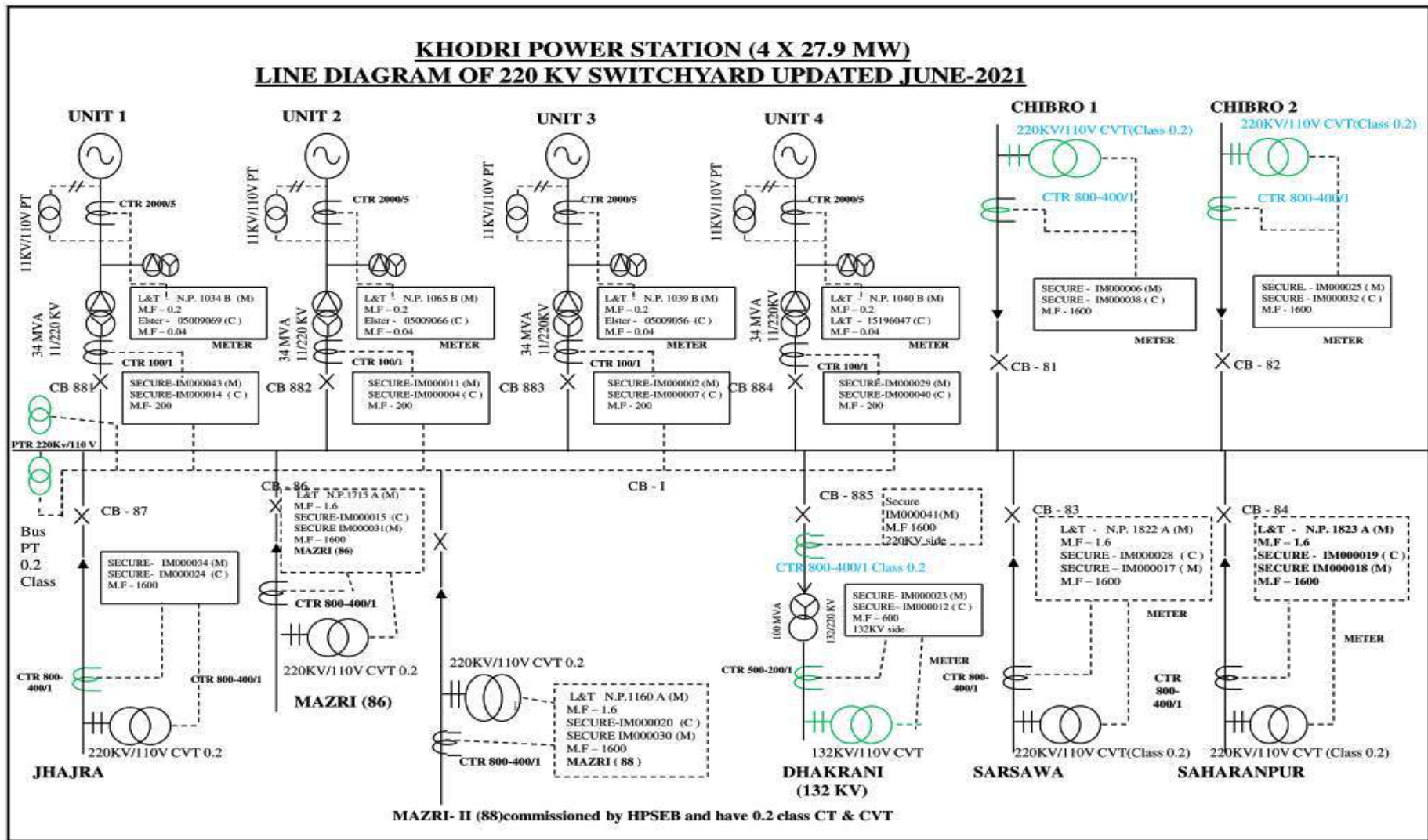

## 1.1: PROTECTION SYSTEM OVERALL REVIEW

220 kV SWITCHYARD KHODRI POWER STATION UJVNL		
DATE OF AUDIT BY CPRI TEAM : 10-10-2023		
Sl. No	Title	Details
1	Name Of Grid Substation	220 kV SWITCHYARD KHODRI POWER STATION UJVNL
2	Highest Voltage Level	220 kV
3	Year Of Installation	1984
4	No Of Feeders	Seven 220 kV Feeder & One 132 kV Feeder
5	No of Transformers, Make and Capacity	4*34 MVA, 220/110 kV
6	Busbar Arrangement	Single Busbar Arrangement
7	Present Busbar Switching Status	Commissioned
8	Busbar Protection	Commissioned
9	Relay System Status	In Service
10	DC Supply System	[1] 220/110 V DC-1 [2] 220/110 V DC-2 [3] 48 V DC-1 [4] 48 V DC-2
11	DC Supply Capacity And Adequacy	Battery is adequate for the station load.
12	DC System Earth Fault Status	Healthy condition.
13	GPS Receiver Make & Model	SANDS
14	GPS Clock Receiver & Synchronization Of Relay Status	Relays are synchronised
15	Common Event Logger Status	In-built feature in numerical relay is used
16	Line Disturbance Recorder	In-built feature in numerical relay is used
17	Fault Locator in Line	Provided
18	Breaker Failure Relay Status	Provided
19	Circuit Breaker test reports	Available
20	Relay test reports	Available
21	General Observation of Relay And Protection System	It is recommended that the all the Numerical Protection IEDs shall be tested once in 3 or 4 years as per the best practices.

**Protection audit teams at site:**

**UJVNL Team Members:**

- |   |                        |                                      |
|---|------------------------|--------------------------------------|
| 1 | Mr. Mr. Anup Deepak    | Executive Engineer(Test), Dakpather  |
| 2 | Mr. Mandeep Singh      | Executive Engineer (Generation), Kps |
| 3 | Mr. Amit Ranjan        | Executive Engineer(Mm&C)             |
| 4 | Mr. Arvind Bahuguna    | Asst Engineer, M&Fdr Prtn            |
| 5 | Mr. Vedpal Arya        | Asst Engineer (Test)                 |
| 6 | Mr. Sharad Raghuvanshi | Asst Engineer (Em)                   |

**CPRI Team Members:**

- |   |                       |                     |
|---|-----------------------|---------------------|
| 1 | Dr. J.Sreedevi        | Joint Director ,Hod |
| 2 | Mr. Ved Prakash Yadav | Engineering Officer |

## 1.2: Relays Used for Transmission Line, Transformer, Reactor and Bus Bar Protection Substation

### 1.2.1: Relays used for Transmission Line Protection

Sl. No.	Name of the Feeder	Main-I	Main-II
1	Khodri - Chibro 1	ABB & REL511	ABB & REL511
2	Khodri - Chibro 2	ABB & REL521	ABB & REL521
3	Khodri - Sarawa	GE Multilin & D60	Alstom & P442
4	Khodri - Saharanpur 2	GE Multilin & D60	Alstom & P442
5	Khodri - Jhjhra	GE Multilin & D60	Alstom & P442
6	Khodri - Mazri 1	GE Multilin & D60	Alstom & P442
7	Khodri - Mazri 2	ABB & REL670	ABB & REL670
8	Khodri - Dhakrani	English Electric & SSRR3V71FF19ED	Electro Mechanical

**1.2.2: Relays used for Transformer Protection:**

Sl. No.	Transformer	Primary Protection	Back Up protection		
		Differential Protection	Over fluxing protection	Back up over current	Back Up REF
1	UNIT- 1	ABB & REG 670	ABB & REG 670	ABB & REG 670	ABB & REG 670
2	UNIT- 2	ABB & REG 670	ABB & REG 670	ABB & REG 670	ABB & REG 670
3	UNIT-3	ABB & REG 670	ABB & REG 670	ABB & REG 670	ABB & REG 670
4	UNIT-4	ABB & REG 670	ABB & REG 670	ABB & REG 670	ABB & REG 670

**1.2.3: Relays used for BUS BAR Protection:**

Sl. No.	Voltage level	Make	Model
1.	220kV	English Electrical	-



## 2.0 Input Data for Transmission Lines

### 2.1. Input Data for Transmission Lines Substation – Khodri - Chibro 1

Sl. No.	Description	Units	Value
	<b>Station Name</b>	<b>220 kV SWITCHYARD KHODRI POWER STATION UJVNL</b>	
<b>1</b>	<b>Line Reference</b>	<b>Khodri - Chibro 1</b>	
1.1	Line voltage level	kV	220
1.2	Name of remote substation		Chibro-1
<b>2</b>	<b>Main 1 Protection</b>		
2.1	Protection Type		Numerical
2.2	Model & Make		ABB REL 511
<b>3</b>	<b>Main 2 Protection</b>		
3.1	Protection Type		Numerical
3.2	Model & Make		ABB REL 521
<b>4</b>	<b>CT data for Main 1</b>		
4.1	Ratio	A/A	800/1
4.2	Class		PS
4.3	Vk / VA burden	Vk/VA	800/30
4.4	Rct	Ohms	5
4.5	Imag @ Vk	mA	30
<b>5</b>	<b>CT data for Main 2</b>		
5.1	Ratio		800/1
5.2	Class		PS
5.3	Vk / VA burden		800/30
5.4	Rct		5
5.5	Imag @ Vk		30
<b>6</b>	<b>PT Ratio</b>	kV/V	220kV/110V
<b>7</b>	<b>PROTECTED LINE DATA</b>		
7.1	Line Length	Km	5.77
7.2	Positive seq. RESISTANCE	Ohms/Km	0.0804
7.3	Positive seq. REACTANCE	Ohms/Km	0.41
7.4	Zero seq. RESISTANCE	Ohms/Km	0.2814
7.5	Zero seq. REACTANCE	Ohms/Km	1.435
<b>8</b>	<b>ADJACENT SHORTEST LINE DATA (from remote bus)</b>		
8.1	Name of the substation to which the shortest adjacent line is connected		<b>Chibro-II</b>
8.2	Line Length of shortest adjacent line	Km	8.59
8.3	Positive seq. RESISTANCE of shortest adjacent line	Ohms/Km	0.0804
8.4	Positive seq. REACTANCE of shortest adjacent line	Ohms/Km	0.41
8.5	Zero seq. RESISTANCE of shortest adjacent line	Ohms/Km	0.2814

8.6	Zero seq. REACTANCE of shortest adjacent line	Ohms/Km	1.435
9	<b>ADJACENT LONGEST LINE DATA (from remote bus)</b>		
9.1	Name of the substation to which the longest adjacent line is connected		<b>Chibro-II</b>
9.2	Line Length of longest adjacent line	Km	8.59
9.3	Positive seq. RESISTANCE of longest adjacent line	Ohms/Km	0.0804
9.4	Positive seq. REACTANCE of longest adjacent line	Ohms/Km	0.41
9.5	Zero seq. RESISTANCE of longest adjacent line	Ohms/Km	0.2814
9.6	Zero seq. REACTANCE of longest adjacent line	Ohms/Km	1.435
10	<b>Is there a transformer connected to the remote bus</b>	Yes/No	YES
10.1	Number of Transformers		3
10.2	Voltage ratio of the Transformer	kV	-
10.3	MVA of the transformers 1	MVA	3*69
10.4	% Impedance of the transformers1	%	12.10

## 2.2. Input Data for Transmission Lines Substation – Khodri - Chibro 2

Sl. No.	Description	Units	Value
	<b>Station Name</b>	<b>220 kV SWITCHYARD KHODRI POWER STATION UJVNL</b>	
<b>1</b>	<b>Line Reference</b>	<b>Khodri - Chibro I1</b>	
1.1	Line voltage level	kV	220
1.2	Name of remote substation		Chibro-II
<b>2</b>	<b>Main 1 Protection</b>		
2.1	Protection Type		Numerical
2.2	Model & Make		ABB REL 511
<b>3</b>	<b>Main 2 Protection</b>		
3.1	Protection Type		Numerical
3.2	Model & Make		ABB REL 521
<b>4</b>	<b>CT data for Main 1</b>		
4.1	Ratio	A/A	800/1
4.2	Class		PS
4.3	Vk / VA burden	Vk/VA	800/30
4.4	Rct	Ohms	5
4.5	Imag @ Vk	mA	30
<b>5</b>	<b>CT data for Main 2</b>		
5.1	Ratio		800/1
5.2	Class		PS
5.3	Vk / VA burden		800/30
5.4	Rct		5
5.5	Imag @ Vk		30
<b>6</b>	<b>PT Ratio</b>	kV/V	220kV/110V
<b>7</b>	<b>PROTECTED LINE DATA</b>		
7.1	Line Length	Km	8.59
7.2	Positive seq. RESISTANCE	Ohms/Km	0.0804
7.3	Positive seq. REACTANCE	Ohms/Km	0.41
7.4	Zero seq. RESISTANCE	Ohms/Km	0.2814
7.5	Zero seq. REACTANCE	Ohms/Km	1.435
<b>8</b>	<b>ADJACENT SHORTEST LINE DATA (from remote bus)</b>		
8.1	Name of the substation to which the shortest adjacent line is connected		<b>Chibro-I</b>
8.2	Line Length of shortest adjacent line	Km	8.59
8.3	Positive seq. RESISTANCE of shortest adjacent line	Ohms/Km	0.0804
8.4	Positive seq. REACTANCE of shortest adjacent line	Ohms/Km	0.41
8.5	Zero seq. RESISTANCE of shortest adjacent line	Ohms/Km	0.2814

8.6	Zero seq. REACTANCE of shortest adjacent line	Ohms/Km	1.435
9	<b>ADJACENT LONGEST LINE DATA (from remote bus)</b>		
9.1	Name of the substation to which the longest adjacent line is connected		<b>Chibro-I</b>
9.2	Line Length of longest adjacent line	Km	8.59
9.3	Positive seq. RESISTANCE of longest adjacent line	Ohms/Km	0.0804
9.4	Positive seq. REACTANCE of longest adjacent line	Ohms/Km	0.41
9.5	Zero seq. RESISTANCE of longest adjacent line	Ohms/Km	0.2814
9.6	Zero seq. REACTANCE of longest adjacent line	Ohms/Km	1.435
10	<b>Is there a transformer connected to the remote bus</b>	Yes/No	-
10.1	Number of Transformers		3
10.2	Voltage ratio of the Transformer	kV	-
10.3	MVA of the transformers 1	MVA	3*69
10.4	% Impedance of the transformers1	%	12.10

### 2.3.Input Data for Transmission Lines Substation – Khodri - Sarsawa

Sl. No.	Description	Units	Value
	Station Name	<b>220 kV SWITCHYARD KHODRI POWER STATION UJVNL</b>	
<b>1</b>	<b>Line Reference</b>	<b>Khodri - Sarsawa</b>	
1.1	Line voltage level	kV	220
1.2	Name of remote substation		<b>Sarsawa</b>
<b>2</b>	<b>Main 1 Protection</b>		
2.1	Protection Type		Numerical
2.2	Model & Make		GE Multilin & D60N03HKHF8LH6DM67P67U6UWXX
<b>3</b>	<b>Main 2 Protection</b>		
3.1	Protection Type		Numerical
3.2	Model & Make		Alstom & P44231AB6M0550K
<b>4</b>	<b>CT data for Main 1</b>		
4.1	Ratio	A/A	800/1
4.2	Class		PS
4.3	Vk / VA burden	Vk/VA	800/30
4.4	Rct	Ohms	5
4.5	Imag @ Vk	mA	30
<b>5</b>	<b>CT data for Main 2</b>		
5.1	Ratio		800/1
5.2	Class		PS
5.3	Vk / VA burden		800/30
5.4	Rct		5
5.5	Imag @ Vk		30
<b>6</b>	<b>PT Ratio</b>	kV/V	220kV/110V
<b>7</b>	<b>PROTECTED LINE DATA</b>		
7.1	Line Length	Km	83.33
7.2	Positive seq. RESISTANCE	Ohms/Km	0.0804
7.3	Positive seq. REACTANCE	Ohms/Km	0.41
7.4	Zero seq. RESISTANCE	Ohms/Km	0.2814
7.5	Zero seq. REACTANCE	Ohms/Km	1.435
<b>8</b>	<b>ADJACENT SHORTEST LINE DATA (from remote bus)</b>		
8.1	Name of the substation to which the shortest adjacent line is connected		<b>Sarsawa-PGCIL Line</b>
8.2	Line Length of shortest adjacent line	Km	10.97

8.3	Positive seq. RESISTANCE of shortest adjacent line	Ohms/Km	0.0793
8.4	Positive seq. REACTANCE of shortest adjacent line	Ohms/Km	0.3975
8.5	Zero seq. RESISTANCE of shortest adjacent line	Ohms/Km	0.2702
8.6	Zero seq. REACTANCE of shortest adjacent line	Ohms/Km	1.2936
9	<b>ADJACENT LONGEST LINE DATA (from remote bus)</b>		
9.1	Name of the substation to which the longest adjacent line is connected		<b>Sarsawa-Saharanpur Line</b>
9.2	Line Length of longest adjacent line	Km	14.49
9.3	Positive seq. RESISTANCE of longest adjacent line	Ohms/Km	0.0804
9.4	Positive seq. REACTANCE of longest adjacent line	Ohms/Km	0.41
9.5	Zero seq. RESISTANCE of longest adjacent line	Ohms/Km	0.2814
9.6	Zero seq. REACTANCE of longest adjacent line	Ohms/Km	1.435
10	<b>Is there a transformer connected to the remote bus</b>	Yes/No	N/A
10.1	Number of Transformers		N/A
10.2	Voltage ratio of the Transformer	kV	N/A
10.3	MVA of the transformers 1	MVA	N/A
10.4	% Impedance of the transformers1	%	N/A

## 2.4.Input Data for Transmission Lines Substation – Khodri - Saharanpur 2

Sl. No.	Description	Units	Value
	<b>Station Name</b>	<b>220 kV SWITCHYARD KHODRI POWER STATION UJVNL</b>	
<b>1</b>	<b>Line Reference</b>	<b>Khodri-Saharanpur-II</b>	
1.1	Line voltage level	kV	220
1.2	Name of remote substation		<b>Saharanpur-II</b>
<b>2</b>	<b>Main 1 Protection</b>		
2.1	Protection Type		Numerical
2.2	Model & Make		GE Multilin & D60N03HKHF8LH6DM67P67U6UWXX
<b>3</b>	<b>Main 2 Protection</b>		
3.1	Protection Type		Numerical
3.2	Model & Make		Alstom & P44231AB6M0550K
<b>4</b>	<b>CT data for Main 1</b>		
4.1	Ratio	A/A	800/1
4.2	Class		PS
4.3	Vk / VA burden	Vk/VA	800/30
4.4	Rct	Ohms	5
4.5	Imag @ Vk	mA	30
<b>5</b>	<b>CT data for Main 2</b>		
5.1	Ratio		800/1
5.2	Class		PS
5.3	Vk / VA burden		800/30
5.4	Rct		5
5.5	Imag @ Vk		30
<b>6</b>	<b>PT Ratio</b>	kV/V	220kV/110V
<b>7</b>	<b>PROTECTED LINE DATA</b>		
7.1	Line Length	Km	81.05
7.2	Positive seq. RESISTANCE	Ohms/Km	0.0804
7.3	Positive seq. REACTANCE	Ohms/Km	0.41
7.4	Zero seq. RESISTANCE	Ohms/Km	0.2814
7.5	Zero seq. REACTANCE	Ohms/Km	1.435
<b>8</b>	<b>ADJACENT SHORTEST LINE DATA (from remote bus)</b>		
8.1	Name of the substation to which the shortest adjacent line is connected		<b>Saharanpur-PGCIL Line</b>

8.2	Line Length of shortest adjacent line	Km	9.08
8.3	Positive seq. RESISTANCE of shortest adjacent line	Ohms/Km	0.0804
8.4	Positive seq. REACTANCE of shortest adjacent line	Ohms/Km	0.41
8.5	Zero seq. RESISTANCE of shortest adjacent line	Ohms/Km	0.2814
8.6	Zero seq. REACTANCE of shortest adjacent line	Ohms/Km	1.435
9	<b>ADJACENT LONGEST LINE DATA (from remote bus)</b>		
9.1	Name of the substation to which the longest adjacent line is connected		<b>Saharanpur-Behat Line</b>
9.2	Line Length of longest adjacent line	Km	35.03
9.3	Positive seq. RESISTANCE of longest adjacent line	Ohms/Km	0.0793
9.4	Positive seq. REACTANCE of longest adjacent line	Ohms/Km	0.3975
9.5	Zero seq. RESISTANCE of longest adjacent line	Ohms/Km	0.2702
9.6	Zero seq. REACTANCE of longest adjacent line	Ohms/Km	1.2936
10	<b>Is there a transformer connected to the remote bus</b>	Yes/No	N/A
10.1	Number of Transformers		N/A
10.2	Voltage ratio of the Transformer	kV	N/A
10.3	MVA of the transformers 1	MVA	N/A
10.4	% Impedance of the transformers1	%	N/A



## 2.5.Input Data for Transmission Lines Substation – Khodri - Jhajhra

Sl. No.	Description	Units	Value
	<b>Station Name</b>	<b>220 kV SWITCHYARD KHODRI POWER STATION UJVNL</b>	
<b>1</b>	<b>Line Reference</b>	<b>Khodri-Jhajhra</b>	
1.1	Line voltage level	kV	220
1.2	Name of remote substation		<b>Jhajhra</b>
<b>2</b>	<b>Main 1 Protection</b>		
2.1	Protection Type		Numerical
2.2	Model & Make		GE Multilin & D60N03HKHF8LH6DM67P67U6UWXX
<b>3</b>	<b>Main 2 Protection</b>		
3.1	Protection Type		Numerical
3.2	Model & Make		Alstom & P44231AB6M0550K
<b>4</b>	<b>CT data for Main 1</b>		
4.1	Ratio	A/A	800/1
4.2	Class		PS
4.3	Vk / VA burden	Vk/VA	800/30
4.4	Rct	Ohms	5
4.5	Imag @ Vk	mA	30
<b>5</b>	<b>CT data for Main 2</b>		
5.1	Ratio		800/1
5.2	Class		PS
5.3	Vk / VA burden		800/30
5.4	Rct		5
5.5	Imag @ Vk		30
<b>6</b>	<b>PT Ratio</b>	kV/V	220kV/110V
<b>7</b>	<b>PROTECTED LINE DATA</b>		
7.1	Line Length	Km	27.53
7.2	Positive seq. RESISTANCE	Ohms/Km	0.0804
7.3	Positive seq. REACTANCE	Ohms/Km	0.41
7.4	Zero seq. RESISTANCE	Ohms/Km	0.2814
7.5	Zero seq. REACTANCE	Ohms/Km	1.435
<b>8</b>	<b>ADJACENT SHORTEST LINE DATA (from remote bus)</b>		
8.1	Name of the substation to which the shortest adjacent line is connected		<b>Jhajhra-PGCIL Line</b>

8.2	Line Length of shortest adjacent line	Km	6.11
8.3	Positive seq. RESISTANCE of shortest adjacent line	Ohms/Km	0.0793
8.4	Positive seq. REACTANCE of shortest adjacent line	Ohms/Km	0.3975
8.5	Zero seq. RESISTANCE of shortest adjacent line	Ohms/Km	0.2702
8.6	Zero seq. REACTANCE of shortest adjacent line	Ohms/Km	1.2936
9	<b>ADJACENT LONGEST LINE DATA (from remote bus)</b>		
9.1	Name of the substation to which the longest adjacent line is connected		<b>Jhjhra-Vyasi Line</b>
9.2	Line Length of longest adjacent line	Km	40.31
9.3	Positive seq. RESISTANCE of longest adjacent line	Ohms/Km	0.0793
9.4	Positive seq. REACTANCE of longest adjacent line	Ohms/Km	0.3975
9.5	Zero seq. RESISTANCE of longest adjacent line	Ohms/Km	0.2702
9.6	Zero seq. REACTANCE of longest adjacent line	Ohms/Km	1.2936
10	<b>Is there a transformer connected to the remote bus</b>	Yes/No	N/A
10.1	Number of Transformers		N/A
10.2	Voltage ratio of the Transformer	kV	N/A
10.3	MVA of the transformers 1	MVA	N/A
10.4	% Impedance of the transformers1	%	N/A

## 2.6.Input Data for Transmission Lines Substation – Khodri - Mazri 1

Sl. No.	Description	Units	Value
	Station Name	<b>220 kV SWITCHYARD KHODRI POWER STATION UJVNL</b>	
<b>1</b>	<b>Line Reference</b>	<b>Khodri - Mazri 1</b>	
1.1	Line voltage level	kV	220
1.2	Name of remote substation		<b>Mazri 1</b>
<b>2</b>	<b>Main 1 Protection</b>		
2.1	Protection Type		Numerical
2.2	Model & Make		GE Multilin & D60N03HKHF8LH6DM67P67U6UWXX
<b>3</b>	<b>Main 2 Protection</b>		
3.1	Protection Type		Numerical
3.2	Model & Make		Alstom & P44231AB6M0550K
<b>4</b>	<b>CT data for Main 1</b>		
4.1	Ratio	A/A	800/1
4.2	Class		PS
4.3	Vk / VA burden	Vk/VA	800/30
4.4	Rct	Ohms	5
4.5	Imag @ Vk	mA	30
<b>5</b>	<b>CT data for Main 2</b>		
5.1	Ratio		800/1
5.2	Class		PS
5.3	Vk / VA burden		800/30
5.4	Rct		5
5.5	Imag @ Vk		30
<b>6</b>	<b>PT Ratio</b>	kV/V	220kV/110V
<b>7</b>	<b>PROTECTED LINE DATA</b>		
7.1	Line Length	Km	35.20
7.2	Positive seq. RESISTANCE	Ohms/Km	0.0793
7.3	Positive seq. REACTANCE	Ohms/Km	0.3975
7.4	Zero seq. RESISTANCE	Ohms/Km	0.2702
7.5	Zero seq. REACTANCE	Ohms/Km	1.2936
<b>8</b>	<b>ADJACENT SHORTEST LINE DATA (from remote bus)</b>		
8.1	Name of the substation to which the shortest adjacent line is connected		<b>Mazri II-Visco</b>
8.2	Line Length of shortest adjacent line	Km	2.65

8.3	Positive seq. RESISTANCE of shortest adjacent line	Ohms/Km	0.0793
8.4	Positive seq. REACTANCE of shortest adjacent line	Ohms/Km	0.3975
8.5	Zero seq. RESISTANCE of shortest adjacent line	Ohms/Km	0.2702
8.6	Zero seq. REACTANCE of shortest adjacent line	Ohms/Km	1.2936
9	<b>ADJACENT LONGEST LINE DATA (from remote bus)</b>		
9.1	Name of the substation to which the longest adjacent line is connected		<b>Khodri-Mazri II</b>
9.2	Line Length of longest adjacent line	Km	35.20
9.3	Positive seq. RESISTANCE of longest adjacent line	Ohms/Km	0.0793
9.4	Positive seq. REACTANCE of longest adjacent line	Ohms/Km	0.3975
9.5	Zero seq. RESISTANCE of longest adjacent line	Ohms/Km	0.2702
9.6	Zero seq. REACTANCE of longest adjacent line	Ohms/Km	1.2936
10	<b>Is there a transformer connected to the remote bus</b>	Yes/No	N/A
10.1	Number of Transformers		N/A
10.2	Voltage ratio of the Transformer	kV	N/A
10.3	MVA of the transformers 1	MVA	N/A
10.4	% Impedance of the transformers1	%	N/A

## 2.7.Input Data for Transmission Lines Substation – Khodri - Mazri 2

Sl. No.	Description	Units	Value
	<b>Station Name</b>	<b>220 kV SWITCHYARD KHODRI POWER STATION UJVNL</b>	
<b>1</b>	<b>Line Reference</b>	<b>Khodri - Mazri II</b>	
1.1	Line voltage level	kV	220
1.2	Name of remote substation		<b>Mazri II</b>
<b>2</b>	<b>Main 1 Protection</b>		
2.1	Protection Type		Numerical
2.2	Model & Make		ABB & REL670
<b>3</b>	<b>Main 2 Protection</b>		
3.1	Protection Type		Numerical
3.2	Model & Make		ABB & REL670
<b>4</b>	<b>CT data for Main 1</b>		
4.1	Ratio	A/A	800/1
4.2	Class		PS
4.3	Vk / VA burden	Vk/VA	800/30
4.4	Rct	Ohms	5
4.5	Imag @ Vk	mA	30
<b>5</b>	<b>CT data for Main 2</b>		
5.1	Ratio		800/1
5.2	Class		PS
5.3	Vk / VA burden		800/30
5.4	Rct		5
5.5	Imag @ Vk		30
<b>6</b>	<b>PT Ratio</b>	kV/V	220kV/110V
<b>7</b>	<b>PROTECTED LINE DATA</b>		
7.1	Line Length	Km	35.20
7.2	Positive seq. RESISTANCE	Ohms/Km	0.0793
7.3	Positive seq. REACTANCE	Ohms/Km	0.3975
7.4	Zero seq. RESISTANCE	Ohms/Km	0.2702
7.5	Zero seq. REACTANCE	Ohms/Km	1.2936
<b>8</b>	<b>ADJACENT SHORTEST LINE DATA (from remote bus)</b>		
8.1	Name of the substation to which the shortest adjacent line is connected		<b>Mazri I-Visco</b>
8.2	Line Length of shortest adjacent line	Km	2.65
8.3	Positive seq. RESISTANCE of shortest adjacent line	Ohms/Km	0.0793
8.4	Positive seq. REACTANCE of shortest adjacent line	Ohms/Km	0.3975
8.5	Zero seq. RESISTANCE of shortest adjacent line	Ohms/Km	0.2702
8.6	Zero seq. REACTANCE of	Ohms/Km	1.2936

	shortest adjacent line		
9	<b>ADJACENT LONGEST LINE DATA (from remote bus)</b>		
9.1	Name of the substation to which the longest adjacent line is connected		<b>Khodri-Mazri I</b>
9.2	Line Length of longest adjacent line	Km	35.20
9.3	Positive seq. RESISTANCE of longest adjacent line	Ohms/Km	0.0793
9.4	Positive seq. REACTANCE of longest adjacent line	Ohms/Km	0.3975
9.5	Zero seq. RESISTANCE of longest adjacent line	Ohms/Km	0.2702
9.6	Zero seq. REACTANCE of longest adjacent line	Ohms/Km	1.2936
10	<b>Is there a transformer connected to the remote bus</b>	Yes/No	YES
10.1	Number of Transformers		2
10.2	Voltage ratio of the Transformer	kV	-
10.3	MVA of the transformers 1	MVA	2*100
10.4	% Impedance of the transformers1	%	12.10

## 2.8.Input Data for Transmission Lines Substation – Khodri - Dhakrani

Sl. No.	Description	Units	Value
	<b>Station Name</b>	<b>220 kV SWITCHYARD KHODRI POWER STATION UJVNL</b>	
<b>1</b>	<b>Line Reference</b>	<b>Khodri - Dhakrani</b>	
1.1	Line voltage level	kV	220
1.2	Name of remote substation		<b>Dhakrani</b>
<b>2</b>	<b>Main 1 Protection</b>		
2.1	Protection Type		Numerical
2.2	Model & Make		English Electric & SSRR3V71FF19ED
<b>3</b>	<b>Main 2 Protection</b>		
3.1	Protection Type		N/A
3.2	Model & Make		N/A
<b>4</b>	<b>CT data for Main 1</b>		<b>N/A</b>
4.1	Ratio	A/A	800/1
4.2	Class		PS
4.3	Vk / VA burden	Vk/VA	800/30
4.4	Rct	Ohms	5
4.5	Imag @ Vk	mA	30
<b>5</b>	<b>CT data for Main 2</b>		
5.1	Ratio		800/1
5.2	Class		PS
5.3	Vk / VA burden		800/30
5.4	Rct		5
5.5	Imag @ Vk		30
<b>6</b>	<b>PT Ratio</b>	kV/V	220kV/110V
<b>7</b>	<b>PROTECTED LINE DATA</b>		
7.1	Line Length	Km	8.835
7.2	Positive seq. RESISTANCE	Ohms/Km	0.1603
7.3	Positive seq. REACTANCE	Ohms/Km	0.4080
7.4	Zero seq. RESISTANCE	Ohms/Km	0.4800
7.5	Zero seq. REACTANCE	Ohms/Km	1.2160
<b>8</b>	<b>ADJACENT SHORTEST LINE DATA (from remote bus)</b>		
8.1	Name of the substation to which the shortest adjacent line is connected		<b>Dhakrani-Dhalipur</b>
8.2	Line Length of shortest adjacent line	Km	5.6
8.3	Positive seq. RESISTANCE of shortest adjacent line	Ohms/Km	0.1603
8.4	Positive seq. REACTANCE of shortest adjacent line	Ohms/Km	0.4080
8.5	Zero seq. RESISTANCE of	Ohms/Km	0.4800

	shortest adjacent line		
8.6	Zero seq. REACTANCE of shortest adjacent line	Ohms/Km	1.2160
9	<b>ADJACENT LONGEST LINE DATA (from remote bus)</b>		
9.1	Name of the substation to which the longest adjacent line is connected		<b>Dhakrani-Dhalipur</b>
9.2	Line Length of longest adjacent line	Km	5.6
9.3	Positive seq. RESISTANCE of longest adjacent line	Ohms/Km	0.1603
9.4	Positive seq. REACTANCE of longest adjacent line	Ohms/Km	0.4080
9.5	Zero seq. RESISTANCE of longest adjacent line	Ohms/Km	0.4800
9.6	Zero seq. REACTANCE of longest adjacent line	Ohms/Km	1.2160
10	<b>Is there a transformer connected to the remote bus</b>	Yes/No	YES
10.1	Number of Transformers		2
10.2	Voltage ratio of the Transformer	kV	-
10.3	MVA of the transformers 1	MVA	2*100
10.4	% Impedance of the transformers1	%	12.10



### 3. Transmission line protective relay settings review

Description	Existing Setting	Reviewed Setting	Existing setting	Reviewed setting
<b>Line Name</b>	<b>Khodri-Chibro-1</b>			
<b>Main I/II</b>	<b>Main-I</b>		<b>Main-II</b>	
<b>Relay</b>	<b>ABB REL 511</b>		<b>ABB REL 521</b>	
<b>ZONE 1</b>	Forward	Forward	Forward	Forward
R(Z1), Resistance for Ph-Ph faults	0.15	0.15	0.15	0.15
X(Z1), Reactance	0.76	0.76	0.76	0.76
RE(Z1), Resistance for ph-gnd	0.44	0.52	0.44	0.52
T1-1phase, delay for single phase	0	0	0	0
T1multi-ph, delay for multi-phase faults	0	0	0	0
<b>ZONE 2</b>	Forward	Forward	Forward	Forward
R(Z2), Resistance for Ph-Ph faults	0.27	0.22	0.27	0.22
X(Z2), Reactance	1.4	1.14	1.4	1.14
RE(Z2), Resistance for ph-gnd	0.8	0.78	0.8	0.78
T2-1phase, delay for single phase	0.4	0.35	0.4	0.35
T2multi-ph, delay for multi-phase	0.4	0.35	0.4	0.35
<b>ZONE 3</b>	Forward	Forward	Forward	Forward
R(Z3), Resistance for Ph-Ph faults	0.54	0.55	0.54	0.55
X(Z3), Reactance	2.78	2.83	2.78	2.83
RE(Z3), Resistance for ph-gnd	1.63	1.94	1.63	1.94
T3 delay	0.8	0.8	0.8	0.8
T3 Multi Phase	0.8	0.8	0.8	0.8
<b>ZONE 4</b>	Reverse	Reverse	Reverse	Reverse
R(Z4), Resistance for Ph-Ph faults	0.1	0.04	0.1	0.04
X(Z4), Reactance	0.19	0.19	0.19	0.19
RE(Z4), Resistance for ph-gnd	0.11	0.13	0.11	0.13
T4 delay	1	0.16	1	0.16
T4 Multi Phase	1	0.16	1	0.16
<b>Power Swing Settings</b>				
Operation	ON	ON	ON	ON
X1In(FW & RV) = 1.1 * maximum of all zone's X1	30.00	7.77	30.00	7.77
R1LIn = maximum of all zone's R1	30.00	1.39	30.00	1.39
tp1(sec) (tp1>=0.03) The general tendency should be to set the tP1 time to at least 30 ms	0.045	0.03	0.045	0.03
tp2(sec) (tp1>=0.01)	0.015	0.01	0.015	0.01

Description	Existing Setting	Reviewed Setting	Existing setting	Reviewed setting
<b>Line Name</b>	<b>Khodri-Chibro-II</b>			
<b>Main I/II</b>	<b>Main-I</b>		<b>Main-II</b>	
<b>Relay</b>	<b>ABB REL 511</b>		<b>ABB REL 521</b>	
<b>ZONE 1</b>	Forward	Forward	Forward	Forward
R(Z1), Resistance for Ph-Ph faults	0.22	0.22	0.22	0.22
X(Z1), Reactance	1.12	1.13	1.12	1.13
RE(Z1), Resistance for ph-gnd	0.66	0.77	0.66	0.77
T1-1phase, delay for single phase	0	0	0	0
T1multi-ph, delay for multi-phase faults	0	0	0	0
<b>ZONE 2</b>	Forward	Forward	Forward	Forward
R(Z2), Resistance for Ph-Ph faults	0.33	0.33	0.33	0.33
X(Z2), Reactance	1.69	1.69	1.69	1.69
RE(Z2), Resistance for ph-gnd	0.99	1.16	0.99	1.16
T2-1phase, delay for single phase	0.6	0.5	0.6	0.5
T2multi-ph, delay for multi-phase	0.6	0.5	0.6	0.5
<b>ZONE 3</b>	Forward	Forward	Forward	Forward
R(Z3), Resistance for Ph-Ph faults	0.51	0.55	0.51	0.55
X(Z3), Reactance	2.63	2.83	2.63	2.83
RE(Z3), Resistance for ph-gnd	1.54	1.94	1.54	1.94
T3 delay	1.2	0.8	1.2	0.8
T3 Multi Phase	1.2	0.8	1.2	0.8
<b>ZONE 4</b>	Reverse	Reverse	Reverse	Reverse
R(Z4), Resistance for Ph-Ph faults	0.1	0.06	0.1	0.06
X(Z4), Reactance	0.28	0.28	0.28	0.28
RE(Z4), Resistance for ph-gnd	0.17	0.19	0.17	0.19
T4 delay	1	0.16	1	0.16
T4 Multi Phase	1	0.16	1	0.16

Description	Existing Setting	Reviewed Setting
<b>Line Name</b>	<b>Khodri-Sarsawa</b>	
<b>Main I/II</b>	<b>Main-I</b>	
<b>Relay</b>	<b>GE-D60</b>	
<b>ZONE-1</b>		
Function	Enabled	Enabled
Direction	Forward	Forward
Shape	Quad	Quad
Xfmr Vol Connection	None	None
Xfmr Curr Connection	None	None
Reach	11.14	<b>11.14</b>
RCA	79	78.91
Rev Reach	2.78	2.7853
Rev Reach RCA	79	78.91
Comp Limit	90	90
DIR RCA	79	78.91
DIR Comp Limit	90	90
Quad Right Blinder	6.29	6.29
Quad Right Blinder RCA	79	78.91
Quad Left Blinder	3.14	3.14
Quad Left Blinder RCA	79	78.91
Supervision	0.200	0.200 pu
Volt Level	0.000	0.000 pu
Delay	0.000	0.000 s
Block	21 BLOCK On(VO10)	21 BLOCK On(VO10)
Target	Latched	Latched
Events	Enabled	Enabled
<b>ZONE-2</b>		
Function	Enabled	Enabled
Direction	Forward	Forward
Shape	Quad	
Xfmr Vol Connection	None	None
Xfmr Curr Connection	None	None
Reach	14.84	<b>14.84</b>
RCA	79	78.91

Rev Reach	2.78	2.7853
Rev Reach RCA	79	78.91
Comp Limit	90	90
DIR RCA	79	78.91
DIR Comp Limit	90	90
Quad Right Blinder	7.71	7.71
Quad Right Blinder RCA	79	78.91
Quad Left Blinder	3.86	3.86
Quad Left Blinder RCA	79	78.91
Supervision	0.200	0.200 pu
Volt Level	0.000	0.000 pu
Delay	0.350	0.350 s
Block		
Target	Latched	Latched
Events	Enabled	Enabled
<b>ZONE-3</b>		
Function	Enabled	Enabled
Direction	Forward	Forward
Shape	Quad	
Xfmr Vol Connection	None	None
Xfmr Curr Connection	None	None
Reach	16.38	<b>16.35</b>
RCA	79	78.91
Rev Reach	2.78	2.7853
Rev Reach RCA	79	78.91
Comp Limit	90	90
DIR RCA	79	78.91
DIR Comp Limit	90	90
Quad Right Blinder	8.29	8.29
Quad Right Blinder RCA	79	78.91
Quad Left Blinder	4.15	4.15
Quad Left Blinder RCA	79	78.91
Supervision	0.200	0.200 pu
Volt Level	0.000	0.000 pu
Delay	1.00	0.800 s
Block		
Target	Latched	Latched
Events	Enabled	Enabled

<b>ZONE-4</b>		
Function	Enabled	Enabled
Direction	Reverse	Reverse
Shape	Quad	
Xfmr Vol Connection	None	None
Xfmr Curr Connection	None	None
Reach	2.79	<b>2.79</b>
RCA	79	78.91
Rev Reach	2.78	2.7853
Rev Reach RCA	79	78.91
Comp Limit	90	90
DIR RCA	79	78.91
DIR Comp Limit	90	90
Quad Right Blinder	3.07	3.07
Quad Right Blinder RCA	79	78.91
Quad Left Blinder	1.54	1.54
Quad Left Blinder RCA	79	78.91
Supervision	0.200	0.200 pu
Volt Level	0.000	0.000 pu
Delay	1.00	1.000 s
Block		
Target	Latched	Latched
Events	Enabled	Enabled

Description	Existing Setting	Reviewed Setting
<b>Line Name</b>	<b>Khodri-Saharanpur II</b>	
<b>Main I/II</b>	<b>Main-I</b>	
<b>Relay</b>	<b>GE-D60</b>	
<b>ZONE-1</b>		
Function	Enabled	Enabled
Direction	Forward	Forward
Shape	Quad	
Xfmr Vol Connection	None	None
Xfmr Curr Connection	None	None
Reach	10.84	10.74
RCA	79	78.91
Rev Reach	2.71	2.6847
Rev Reach RCA	79	78.91
Comp Limit	90	90
DIR RCA	79	78.91
DIR Comp Limit	90	90
Quad Right Blinder	6.17	6.11
Quad Right Blinder RCA	79	78.91
Quad Left Blinder	3.09	3.06
Quad Left Blinder RCA	79	78.91
Supervision	0.200	0.200 pu
Volt Level	0.000	0.000 pu
Delay	0.000	0.000 s
Block		
Target	Latched	Latched
Events	Enabled	Enabled
<b>ZONE-2</b>		
Function	Enabled	Enabled
Direction	Forward	Forward
Shape	Quad	
Xfmr Vol Connection	None	None
Xfmr Curr Connection	None	None
Reach	14.30	<b>14.18</b>
RCA	79	78.91
Rev Reach	2.71	2.6847

Rev Reach RCA	79	78.91
Comp Limit	90	90
DIR RCA	79	78.91
DIR Comp Limit	90	90
Quad Right Blinder	7.51	7.44
Quad Right Blinder RCA	79	78.91
Quad Left Blinder	3.75	3.72
Quad Left Blinder RCA	79	78.91
Supervision	0.200	0.200 pu
Volt Level	0.000	0.000 pu
Delay	0.350	0.350 s
Block		
Target	Latched	Latched
Events	Enabled	Enabled
<b>ZONE-3</b>		
Function	Enabled	Enabled
Direction	Forward	Forward
Shape	Quad	Quad
Xfmr Vol Connection	None	None
Xfmr Curr Connection	None	None
Reach	19.40	<b>19.22</b>
RCA	79	78.91
Rev Reach	2.71	2.6847
Rev Reach RCA	79	78.91
Comp Limit	90	90
DIR RCA	79	78.91
DIR Comp Limit	90	90
Quad Right Blinder	9.47	9.38
Quad Right Blinder RCA	79	78.91
Quad Left Blinder	4.73	4.69
Quad Left Blinder RCA	79	78.91
Supervision	0.200	0.200 pu
Volt Level	0.000	0.000 pu
Delay	1.000	0.800 s
Block		
Target	Latched	Latched
Events	Enabled	Enabled
<b>ZONE-4</b>		

Function	Enabled	Enabled
Direction	Reverse	Reverse
Shape	Quad	Quad
Xfmr Vol Connection	None	None
Xfmr Curr Connection	None	None
Reach	2.71	<b>2.68</b>
RCA	79	78.91
Rev Reach	2.71	2.6847
Rev Reach RCA	79	78.91
Comp Limit	90	90
DIR RCA	79	78.91
DIR Comp Limit	90	90
Quad Right Blinder	3.04	3.02
Quad Right Blinder RCA	79	78.91
Quad Left Blinder	1.52	1.51
Quad Left Blinder RCA	79	78.91
Supervision	0.200	0.200 pu
Volt Level	0.000	0.000 pu
Delay	1.000	1.000 s
Block		
Target	Latched	Latched
Events	Enabled	Enabled



Description	Existing Setting	Reviewed Setting
<b>Line Name</b>	<b>Khodri-Jhajhra</b>	
<b>Main I/II</b>	<b>Main-I</b>	
<b>Relay</b>	<b>GE-D60</b>	
<b>ZONE-1</b>		
Function	Enabled	Enabled
Direction	Forward	Forward
Shape	Quad	Quad
Xfmr Vol Connection	None	None
Xfmr Curr Connection	None	None
Reach	3.68	3.65
RCA	79	78.91
Rev Reach	0.92	0.9119
Rev Reach RCA	79	78.91
Comp Limit	90	90
DIR RCA	79	78.91
DIR Comp Limit	90	90
Quad Right Blinder	3.42	3.39
Quad Right Blinder RCA	79	78.91
Quad Left Blinder	1.71	1.69
Quad Left Blinder RCA	79	78.91
Supervision	0.200	0.200 pu
Volt Level	0.00	0.000 pu
Delay	0.00	0.000 s
Block		
Target	Latched	Latched
Events	Enabled	Enabled
<b>ZONE-2</b>		
Function	Enabled	Enabled
Direction	Forward	Forward
Shape	Quad	
Xfmr Vol Connection	None	None
Xfmr Curr Connection	None	None
Reach	5.11	<b>5.07</b>
RCA	79	78.91
Rev Reach	0.92	0.9119

Rev Reach RCA	79	78.91
Comp Limit	90	90
DIR RCA	79	78.91
DIR Comp Limit	90	90
Quad Right Blinder	3.97	3.93
Quad Right Blinder RCA	79	78.91
Quad Left Blinder	1.98	1.97
Quad Left Blinder RCA	79	78.91
Supervision	0.200	0.200 pu
Volt Level	0.000	0.000 pu
Delay	0.350	0.350 s
Block		
Target	Latched	Latched
Events	Enabled	Enabled
<b>ZONE-3</b>		
Function	Enabled	Enabled
Direction	Forward	Forward
Shape	Quad	
Xfmr Vol Connection	None	None
Xfmr Curr Connection	None	None
Reach	11.34	<b>11.24</b>
RCA	79	78.91
Rev Reach	0.92	0.9119
Rev Reach RCA	79	78.91
Comp Limit	90	90
DIR RCA	79	78.91
DIR Comp Limit	90	90
Quad Right Blinder	6.36	6.31
Quad Right Blinder RCA	79	78.91
Quad Left Blinder	3.18	3.15
Quad Left Blinder RCA	79	78.91
Supervision	0.200	0.200 pu
Volt Level	0.000	0.000 pu
Delay	1.00	0.800 s
Block		
Target	Latched	Latched
Events	Enabled	Enabled
<b>ZONE-4</b>		

Function	Enabled	Enabled
Direction	Reverse	Reverse
Shape	Quad	
Xfmr Vol Connection	None	None
Xfmr Curr Connection	None	None
Reach	0.92	<b>0.91</b>
RCA	79	78.91
Rev Reach	0.92	0.9119
Rev Reach RCA	79	78.91
Comp Limit	90	90
DIR RCA	79	78.91
DIR Comp Limit	90	90
Quad Right Blinder	2.35	2.33
Quad Right Blinder RCA	79	78.91
Quad Left Blinder	1.18	1.17
Quad Left Blinder RCA	79	78.91
Supervision	0.200	0.200 pu
Volt Level	0.00	0.000 pu
Delay	1.000	1.000 s
Block		
Target	Latched	Latched
Events	Enabled	Enabled

Description	Existing Setting	Reviewed Setting
<b>Line Name</b>	<b>Khodri-Mazri I</b>	
<b>Main I/II</b>	<b>Main-I</b>	
<b>Relay</b>	<b>GE-D60</b>	
<b>ZONE-1</b>		
Function	Enabled	Enabled
Direction	Forward	Forward
Shape	Quad	Quad
Xfmr Vol Connection	None	None
Xfmr Curr Connection	None	None
Reach	4.57	4.52
RCA	79	78.72
Rev Reach	1.14	1.1311
Rev Reach RCA	79	78.72
Comp Limit	90	90
DIR RCA	79	78.72
DIR Comp Limit	90	90
Quad Right Blinder	3.79	3.75
Quad Right Blinder RCA	79	78.72
Quad Left Blinder	1.89	1.88
Quad Left Blinder RCA	79	78.72
Supervision	0.200	0.200 pu
Volt Level	0.000	0.000 pu
Delay	0.000	0.000 s
Block		
Target	Latched	Latched
Events	Enabled	Enabled
<b>ZONE-2</b>		
Function	Enabled	Enabled
Direction	Forward	Forward
Shape	Quad	Quad
Xfmr Vol Connection	None	None
Xfmr Curr Connection	None	None
Reach	5.92	<b>5.87</b>
RCA	79	78.72
Rev Reach	1.14	1.1311

Rev Reach RCA	79	78.72
Comp Limit	90	90
DIR RCA	79	78.72
DIR Comp Limit	90	90
Quad Right Blinder	4.32	4.28
Quad Right Blinder RCA	79	78.72
Quad Left Blinder	2.16	2.14
Quad Left Blinder RCA	79	78.72
Supervision	0.200	0.200 pu
Volt Level	0.000	0.000 pu
Delay	0.350	0.350 s
Block		
Target	Latched	Latched
Events	Enabled	Enabled
<b>ZONE-3</b>		
Function	Enabled	Enabled
Direction	Forward	Forward
Shape	Quad	Quad
Xfmr Vol Connection	None	None
Xfmr Curr Connection	None	None
Reach	11.41	<b>11.31</b>
RCA	79	78.72
Rev Reach	1.14	1.1311
Rev Reach RCA	79	78.72
Comp Limit	90	90
DIR RCA	79	78.72
DIR Comp Limit	90	90
Quad Right Blinder	6.47	6.41
Quad Right Blinder RCA	79	78.72
Quad Left Blinder	3.23	3.2
Quad Left Blinder RCA	79	78.72
Supervision	0.200	0.200 pu
Volt Level	0.000	0.000 pu
Delay	1.000	0.800 s
Block		
Target	Latched	Latched
Events	Enabled	Enabled
<b>ZONE-4</b>		

Function	Enabled	Enabled
Direction	Reverse	Reverse
Shape	Quad	Quad
Xfmr Vol Connection	None	None
Xfmr Curr Connection	None	None
Reach	1.14	<b>1.13</b>
RCA	79	78.72
Rev Reach	1.14	1.1311
Rev Reach RCA	79	78.72
Comp Limit	90	90
DIR RCA	79	78.72
DIR Comp Limit	90	90
Quad Right Blinder	2.45	2.42
Quad Right Blinder RCA	79	78.72
Quad Left Blinder	1.22	1.21
Quad Left Blinder RCA	79	78.72
Supervision	0.200	0.200 pu
Volt Level	0.000	0.000 pu
Delay	1.000	1.000 s
Block		
Target	Latched	Latched
Events	Enabled	Enabled

Description	Existing Setting	Reviewed Setting
<b>MICOM P442</b>	<b>220KV Khodri-Sarsawa</b>	
<b>Line Settings</b>	<b>MAIN-2</b>	
Line Length	83.33	83.33
Line Impedance	13.92	13.92
Line Angle	79	79
Zone Status	110010	110010
kZ1 Res Compensation	0.834	0.833
k Z1 Angle	0	0
Z1	11.13	11.141
R1 G	<b>55.67</b>	<b>24.779</b>
R1 Ph	22.27	18.585
tZ1	0	0
kZ2 Res Compensation	0.834	0.8333
kZ2 Angle	0	0
Z2	<b>14.83</b>	<b>16.712</b>
R2 G	74.17	24.779
R2 Ph	29.67	18.585
tZ2	0.35	0.35
kZ3/4 Res Compensation	0.834	0.8333
kZ3/4 Angle	0	0
Z3	19.12	19.62
R3G - R4G	<b>95.61</b>	<b>24.78</b>
R3Ph - R4Ph	<b>38.24</b>	<b>18.58</b>
tZ3	-	1
Z4	2.78	2.79
tZ4	<b>1</b>	<b>0.5</b>
Status	Enabled	Enabled
Broken conductor	Enable	Enabled

Description	Existing Setting	Reviewed Setting
<b>MICOM P442</b>	<b>220KV Khodri-Saharanpur II</b>	
Line Settings	MAIN-2	
Line Length	81.05	81.05
Line Impedance	13.54	13.54
Line Angle	79	79
Zone Status	110010	110010
kZ1 Res Compensation	0.834	0.833
k Z1 Angle	0	0
Z1	10.83	10.836
R1 G	54.15	24.779
R1 Ph	21.66	18.585
tZ1	0	0
kZ2 Res Compensation	0.834	0.8333
kZ2 Angle	0	0
Z2	14.29	16.254
R2 G	71.47	24.779
R2 Ph	28.59	18.585
tZ2	0.35	0.35
kZ3/4 Res Compensation	0.834	0.8333
kZ3/4 Angle	0	0
Z3	19.39	23.05
R3G - R4G	96.94	24.78
R3Ph - R4Ph	38.77	18.58
tZ3	1	1
Z4	2.71	2.71
tZ4	1	0.5
Status	Enabled	Enabled
Broken conductor	Enable	Enabled



Description	Existing Setting	Reviewed Setting
<b>MICOM P442</b>	<b>220KV Khodri-Jhajhra</b>	
<b>Line Settings</b>	<b>MAIN-2</b>	
Line Length	27.53	81.05
Line Impedance	4.597	4.597
Line Angle	79	79
Zone Status	110010	110010
kZ1 Res Compensation	0.834	0.833
k Z1 Angle	0	0
Z1	3.68	3.681
R1 G	<b>18.4</b>	<b>24.779</b>
R1 Ph	<b>7.36</b>	<b>18.585</b>
tZ1	0	0
kZ2 Res Compensation	0.834	0.8333
kZ2 Angle	0	0
Z2	5.11	5.521
R2 G	25.55	24.779
R2 Ph	<b>10.22</b>	<b>18.585</b>
tZ2	0.35	0.35
kZ3/4 Res Compensation	0.833	0.8333
kZ3/4 Angle	0	0
Z3	<b>11.33</b>	<b>13.61</b>
R3G - R4G	<b>56.68</b>	<b>24.78</b>
R3Ph - R4Ph	<b>22.67</b>	<b>18.58</b>
tZ3	1	1
Z4	1.15	0.92
tZ4	<b>1</b>	<b>0.5</b>
Status	Enabled	Enabled
Broken conductor	Enable	Enabled

Description	Existing Setting	Reviewed Setting
<b>MICOM P442</b>	<b>220KV Khodri-Mazri I</b>	
<b>Line Settings</b>	<b>MAIN-2</b>	
Line Length	35.2	35.2
Line Impedance	5.71	5.71
Line Angle	79	79
Zone Status	110010	110010
kZ1 Res Compensation	0.753	0.753
k Z1 Angle	-0.7	-0.744
Z1	4.57	4.566
R1 G	<b>22.83</b>	<b>24.725</b>
R1 Ph	<b>9.13</b>	<b>18.543</b>
tZ1	0	0
kZ2 Res Compensation	0.753	0.7535
kZ2 Angle	-0.7	-0.7444
Z2	5.92	6.849
R2 G	<b>29.61</b>	<b>24.725</b>
R2 Ph	<b>11.84</b>	<b>18.543</b>
tZ2	0.35	0.35
kZ3/4 Res Compensation	0.753	0.7535
kZ3/4 Angle	-0.7	-0.7444
Z3	12.56	13.7
R3G - R4G	<b>62.78</b>	<b>24.72</b>
R3Ph - R4Ph	<b>25.11</b>	<b>18.54</b>
tZ3	1	1
Z4	1.14	1.14
tZ4	<b>1</b>	<b>0.5</b>
Status	Enabled	Enabled
Broken conductor	Enable	Enabled

Description	Existing Setting	Reviewed Setting
<b>Line Name</b>	<b>Khodri-Mazri-II</b>	
<b>Main I/II</b>	<b>Main-I &amp; Main II</b>	
<b>Relay</b>	<b>ABB REL 670</b>	
<b>ZONE 1</b>	Forward	Forward
X(Z1), Reactance	-	11.19
R(Z1), Resistance for Ph-Ph faults	-	2.23
ZPP/ZPE	<b>10.924</b>	<b>11.41</b>
ZAngPE	78	78.72
TPP/TPE	0	0
<b>ZONE 2</b>	Forward	Forward
X(Z1), Reactance	-	20.99
R(Z1), Resistance for Ph-Ph faults	-	4.19
ZPP/ZPE	<b>14.168</b>	<b>21.40</b>
ZAngPE	78	78.72
TPP/TPE	0.4	0.5
<b>ZONE 3</b>	Forward	Forward
X(Z1), Reactance	-	33.58
R(Z1), Resistance for Ph-Ph faults	-	6.70
ZPP/ZPE	<b>27.309</b>	<b>34.24</b>
ZAngPE	78	78.72
TPP/TPE	0.8	0.8
<b>ZONE 4</b>	Reverse	Reverse
X(Z1), Reactance	-	2.80
R(Z1), Resistance for Ph-Ph faults	-	0.56
ZPP/ZPE	2.731	2.85
ZAngPE	78	78.72
TPP/TPE	1.5	0.16

Description	Existing Setting	Reviewed Setting
<b>Line Name</b>	<b>Khodri-Dhakrani</b>	
<b>Main I/II</b>	<b>Main-I &amp; Main II</b>	
<b>Relay</b>	<b>RR3B English Electric</b>	
<b>ZONE 1</b>	Forward	Forward
X(Z1), Reactance	1.22	1.202
R(Z1), Resistance for Ph-Ph faults	-	3.910
<b>ZONE 2</b>	Forward	Forward
X(Z1), Reactance	1.83	1.802
R(Z1), Resistance for Ph-Ph faults	-	4.146
<b>ZONE 3</b>	Forward	Forward
X(Z1), Reactance	<b>4.92</b>	<b>2.945</b>
R(Z1), Resistance for Ph-Ph faults	-	4.594

#### 4.0 Input Data for Transformer Protection

Sl. No.	Description	Units	Value
1	<b>Transformer Name</b>		ICT-Unit 1,2,3 & 4
1.1	<b>Ratings</b>		
1.2	MVA	MVA	200
2	Voltage Ratio	kV/kV	230/11
3	<b>Impedance</b>	%	13.7
4	<b>Vector Group</b>		YNd11
5	<b>NGR Data (if Present)</b>	Ohms	-
5.1	<b>OLTC Present</b>	Yes/No	Yes
5.2	OLTC Data		
5.3	Min Tap (%)	% (-)	-15
5.4	Max Tap (%)	% (+)	15
6	No. of Steps		5
6.1	<b>Differential Protection provided</b>	Yes/No	Yes
6.2	Differential CT Ratio		
6.3	HV CT Ratio (Main & ICT)	A/A	800/1
7	LV CT Ratio (Main & ICT)	A/A	2000/1
7.1	<b>Differential Relay</b>		
7.2	Make		ABB
8	Model		REG 670
8.1	<b>Backup REF provided</b>	Yes/No	Yes

8.2	REF Protection CTs Ratio ( <b>Main &amp; ICT</b> )	A/A	HV: 800/1 LV: NIL
8.3	Acc Class		PS
8.4	RCT ( $\Omega$ )	Ohms	5
8.5	Vk(V)	V	>2000
8.6	Im@Vk/2	mA	30
8.7	Longest sec. one way lead R $\Omega$	Ohms	1.3065
8.8	REF Relay		
8.9	Make		ABB
8.10	Model		REG 670
9	Rstab Range ( $\Omega$ )	Ohms	2848.40
9.1	<b>Over fluxing Protection provided</b>	Yes/No	Yes
9.2	Over fluxing Protection Relay		
9.3	Make		ABB
10	Model		REG 670
10.1	<b>Backup Over Current</b>	Yes/No	Yes
10.2	Backup Over Current Protection Relay		
10.3	Make		ABB
10.4	Model		REG 670
10.5	Back-Up Over Current Protection CTs Ratio	A/A	-
			-

#### 4.1 Transformers Protection Relay Setting Review

Sl.No	Protection	Discription	Existing Settings	Reviewed Settings
		Name	<b>ICT-Unit 1,2,3 &amp; 4</b>	
		Type of Relay Used	<b>ABB REG 670</b>	
		Line Voltage (kV)	220	
		Capacity In MVA	100	
<b>1</b>	<b>Transformer Differential</b>	Operation	On	On
		IDiffAlarm	0.1	0.1
		tAlarmDelay	10	10
		IdMin	0.2	0.2
		EndSection1	1.25	1.25
		EndSection2	3	3
		SlopeSection2	40	40
		SlopeSection3	80	80
		IdUnre	9.6	9.6
		I2/I1Ratio	15	15
		I5/I1Ratio	25	25
<b>2</b>	<b>REF Protection</b>	High/Low Impedance Settings:	High Impedence	
		Rated Current of the in Primary Amps	3000	
		Equivalent secondary current in amps	1	
		Maximum Bus fault current in Amps	50000	
		Equivalent sec. fault current in Amps	16.66666667	
		Differential Pickup Settings in Amps	300	
		Equivalent Secondary current in Amps	0.1	

<b>3</b>	<b>Phase Over Current (51/67)</b>	Operation	On	On
		I <sub>Base</sub>	289	289
		U <sub>Base</sub>	400	400
		Angle <sub>RCA</sub>	65	65
		Angle <sub>ROA</sub>	80	80
		DirMode1	Forward	Forward
		Characterist1	IEC Norm. inv.	IEC Norm. inv.
		I <sub>1&gt;</sub>	120	120
		t1	0	0
		DirMode2	Non-directional	Non-directional
		Characterist2	IEC Def. Time	IEC Def. Time
		I <sub>2&gt;</sub>	900	900
		t2	0.05	0.05
		<b>4</b>	<b>Residual Over Current (51N/67N)</b>	Operation
I <sub>base</sub>	289			289
U <sub>base</sub>	400			400
Angle <sub>RCA</sub>	65			65
DirMode1	Forward			Forward
Characterist1	IEC Norm. inv.			IEC Norm. inv.
I <sub>N1&gt;</sub>	30			30
t1	0			0
DirMode2	Non-directional			Non-directional
Characterist2	IEC Def. Time			IEC Def. Time
I <sub>N2&gt;</sub>	900			900
t2	0.05			0.05
k2	1			1



<b>5</b>	<b>Breaker Failure</b>	Operation	On	On
		Ibase	1125	1125
		FunctionMode	Current	Current
		BuTripMode	1 Out of 3	1 Out of 3
		RetripMode	No CBPos Check	No CBPos Check
		IP>	5	5
		IN>	5	5
		t1	0.05	0.05
		t2	0.2	0.2

## 5 DC Measurements

DC battery and chargers are very important units as they are required to operate the protection relays. In this section, the details of the batteries and chargers are provided.

Following is the measurement of DC source which was taken during the site visit:

### A. DC Supply

		<b>Positive to Negative</b>	<b>Positive to Earth</b>	<b>Negative To Earth</b>
1	DC Bank 1	237.67	+152.40	-84.60

## 6. Protection Review and Recommendations:

In general, protection schemes and setting are in order. All the 400 kV lines, Transformers are protected through numerical based Protection schemes.

1. The distance protection Main-I & II of all Zone impedance reach setting for Khodri - Chibro-I lines are properly set.
2. The distance protection Main-I & II of all Zone impedance reach setting for Khodri - Chibro-II lines are properly set.
3. The distance protection Main-I of all Zone impedance reach setting for Khodri-Sarsawa , Khodri-Saharanpur II , Khodri-Jhajhra & Khodri-Mazri I lines are properly set.
4. The distance protection Main-II, Zone 1 & Zone 3 impedance reach setting for Khodri-Sarsawa are properly set and some minor revisions are required in Zone 2 impedance reach settings.
5. The distance protection Main-II, Zone 1 impedance reach setting for Khodri-Saharanpur II are properly set and some minor revisions are required in Zone 2 & Zone 3 impedance reach settings.
6. The distance protection Main-II, Zone 1 impedance reach setting for Khodri-Mazri I properly set and some minor revisions are required in Zone 2 & Zone 3 impedance reach settings.
7. Some revisions are required in Zone 1, Zone 2 & Zone 3 impedance reach settings for Khodri-Mazri II.
8. The distance protection Main-I Zone 1 & Zone 2 impedance reach setting for Khodri-Dhakrani are properly set and some minor revisions are required in Zone 3 impedance reach settings. the available protection is electromechanical type. This needs to be upgraded with the latest numerical IED.
9. The earth fault protection is also protected to all line protection. Power swing, CB fail, and broken conductor is also provided on all lines. Minor changes in Power swing.
10. Resistive reach for Ph-Ph & Ph-Gnd may be reviewed for all the Lines. Since, For the calculation of resistive reach (Ph-Ph & Ph-Gnd), CPRI considered the Arc Resistance and Tower footing resistance as 28.864  $\Omega$  & 10  $\Omega$  respectively. If the Arc Resistance and Tower footing resistance values are different at the substation based on local substation condition, then all resistive reach (Ph-Ph & Ph-Gnd) same setting may be retained.
11. Other Protection functionality for lines like broken conductor Voltage supervision and Carrier communication are working satisfactory.
12. The differential protection setting for transformers are properly set and stable.
13. The differential protection setting for busbar are properly set and stable.
14. Relay coordination has been reviewed and some minor variation is required for few settings. The same has been provided in relay coordination sheet.
15. It is suggested to perform the third-party protection audit of substation/generating station periodically.

**Note:** Difference observed between existing settings and reviewed settings are given in bold font in respective protection.

## **7. Review of reports**

### **Review of test reports of CTs & CVTs:**

Pre-commissioning test reports were provided for all relays and CTs & CVT and these were reviewed. It is recommended that pre-commissioning reports of all relays, CTs and CVTs should be kept properly and they should be mandatorily provided whenever they are required to be reviewed. It is also recommended that routine testing of all relays should be carried out regularly in future.

### **Review of test reports of Circuit Breaker:**

Test reports of all Circuit Breakers were provided and reviewed. It is recommended that pre-commissioning reports of all circuit breakers should be kept properly and they should be mandatorily being provided whenever they are required to be reviewed. It is also recommended that routine testing of all circuit breakers should be carried out regularly in future.

# **CONSULTANCY REPORT**

## **Protection audit of 220kV Substation at 120MW Khodri Power House VOLUME-I**

**Clients Reference: PO NO: 5300000132  
CPRI Reference: No. 2/9/PSD/UJVNL/2022-23  
CPRI Report: No. 2/9/PSD/RT99/2023**

**CUSTOMER**  
**M/s UJVNL, Dehradun**

### **CONSULTANT**



**POWER SYSTEMS DIVISION  
CENTRAL POWER RESEARCH INSTITUTE  
Sir. C.V.RAMAN ROAD, P.B. NO. 8066  
SADASHIVANAGAR P.O  
BANGALORE – 560 080.  
Website : <http://www.cpri.res.in>  
November 2023**

## Current Transformer

Sl. no	Location	CT ratio	Make and Model	CT serial no	Date of commissioning	Date of last testing	Serviceable/ Non Serviceable in case of Breakdown	Remarks
1	Unit no 1	800/1	ABB	R-2109575	2009	2009	Serviceable	The life span of CT is 25 years. Test report shows that Tan delta and accuracy are well within limits. The performance of CT is satisfactory
				Y-2109575	2009	2009		
				B-2109575	2009	2009		
2	Unit no 2	100/1	ABB	R-2109570	2009	2009	Serviceable	
				Y-2109566	2009	2009		
				B-2109563	2009	2009		
3	Unit no 3	100/1	ABB	R-2109568	2009	2009	Serviceable	
				Y-2109571	2009	2009		
				B-2109569	2009	2009		
4	Unit no 4	100/1	ABB	R-2109574	2009	2009	Serviceable	
				Y-2109573	2009	2009		
				B-2109567	2009	2009		
5	220 kV Khodri - Chibro 1 (81)	800/1	BHEL	R-2051371	2021-22	2021-22	Serviceable	
				Y-2051372	2021-22	2021-22		
				B-2051373	2021-22	2021-22		
6	220 kV Khodri - Chibro 2 (82)	800/1	BHEL	R-2051383	2021-22	2021-22	Serviceable	
				Y-2051384	2021-22	2021-22		
				B-2051385	2021-22	2021-22		
7	220 kV Khodri - Jhajra (87)	800/1	BHEL	R-2051394	2021-22	2021-22	Serviceable	
				Y-2051392	2021-22	2021-22		
				B-2051393	2021-22	2021-22		

8	220 kV Khodri - Saharanpur 1 (83)	800/1	BHEL	R-2051378	2021-22	2021-22	Serviceable	CTs commissioned in the year 2021-22 and all the tests were conducted during commissioning. Performance of the CTs is satisfactory.
				Y-2051379	2021-22	2021-22		
				B-2051377	2021-22	2021-22		
9	220 kV Khodri - Saharanpur 2 (84)	800/1	BHEL	R-2051382	2021-22	2021-22	Serviceable	
				Y-2051380	2021-22	2021-22		
				B-2051381	2021-22	2021-22		
10	220/132 kV Khodri - Dhakrani (785)	500/1	BHEL	R-2051395	2021-22	2021-22	Serviceable	
				Y-2051396	2021-22	2021-22		
				B-2051397	2021-22	2021-22		
11	220 kV Khodri - Majri 1 (86)	800/1	BHEL	R-2051390	2021-22	2021-22	Serviceable	
				Y-2051389	2021-22	2021-22		
				B-2051391	2021-22	2021-22		
12	220 kV Khodri - Majri 2 (88)	800/1	SCT	R-2002/668	2021-22	2021-22	Serviceable	
				Y-2002/1667	2021-22	2021-22		
				B-2002/666	2021-22	2021-22		
13	220 kV 100 MVA Auto Transformer (885)	800/1	BHEL	R-2051387	2021-22	2021-22	Serviceable	
				Y-2051386	2021-22	2021-22		
				B-2051388	2021-22	2021-22		

### Capacitive Voltage Transformer

Sl. no	Location	CVT ratio	Make and Model	CVT serial no	Date of commissioning	Date of last testing	Serviceable/ Non Serviceable	Remarks
1	DHAKRANI	132kV/110 V	SIEMENS	1CV 3653 / 3 CORE	9/5/2020	9/5/2020	Serviceable	CVTs commissioned in the year 2020 and all the tests were conducted during commissioning. Performance of the CVTs is satisfactory.
2				1CV 3655 / 3 CORE	9/5/2020	9/5/2020		
3				1CV 3654 / 3 CORE	9/5/2020	9/5/2020		
4	CHIBRO 1	220kV/110 V		1CV 5915 / 3 CORE	15/5/2020	15/5/2020	Serviceable	
5				1CV 5916 / 3 CORE	15/5/2020	15/5/2020		
6				1CV 5917 / 3 CORE	15/5/2020	15/5/2020		
7	CHIBRO 2			2CV 5918 / 2 CORE	9/5/2020	9/5/2020	Serviceable	
8				2CV 5919 / 2 CORE	9/5/2020	9/5/2020		
9				2CV 5920 / 2 CORE	15/05/2020	15/05/2020		
10	SAHARANPUR & SARSAWA			2CV 5921 / 2 CORE	14/05/2020	14/05/2020	Serviceable	
11				2CV 5922 / 2 CORE	14/05/2020	14/05/2020		
12				2CV 5923 / 2 CORE	14/05/2020	14/05/2020		
13	JHAJRA			2CV 5924 / 2 CORE	9/5/2020	9/5/2020	Serviceable	
14				2CV 5925 / 2 CORE	14/05/2020	14/05/2020		
15				2CV 5926 / 2 CORE	9/5/2020	9/5/2020		
16	MAZRI 1 & 2			2CV 5927 / 2 CORE	14/05/2020	14/05/2020	Serviceable	
17				2CV 5928 / 2 CORE	9/5/2020	9/5/2020		
18				2CV 5929 / 2 CORE	14/05/2020	14/05/2020		



# CIRCUIT BREAKER

Sl. no	Location	Make and Model	Serial Number	Status of Breaker available or not	Number of Trip/close coil and healthiness	Date of commissioning	Date of Last timing taken	Operating time (ms)	Serviceable/ Non serviceable	Remarks
<b>A</b>	<b>220 kV System</b>									
1	220 kV Bay 1 U# 01	CGL, 200-SFM-40A	16489C	YES	6/6 Healthy	2002	11/17/2022	21.1	Serviceable	The opening time is well within the limit and performance of CB is satisfactory.
2	220 kV Bay 2 U# 02		16470C	YES	6/6 Healthy	2002	11/17/2022	22.5	Serviceable	
3	220 kV Bay 3 U# 03		16468C	YES	6/6 Healthy	2002	11/17/2022	22.8	Serviceable	
4	220 kV Bay 4 U# 04		16467C	YES	6/6 Healthy	2002	11/17/2022	22.6	Serviceable	
5	220 kV Bay 5 B/C (85)	ABB, LTB245 E-1	30000162	YES	6/6 Healthy	2016	2016	-	Serviceable	CBs commissioned in the year 2016 and all the tests were conducted during commissioning. Performance of the CBs is satisfactory.
6	220 kV Bay 6 Fdr no. 82		30000157	YES	6/6 Healthy	2016	2016	-	Serviceable	
7	220 kV Bay 7 Fdr no. 87		30000161	YES	6/6 Healthy	2016	2016	-	Serviceable	
8	220 kV Bay 8 Fdr no. 84		30000159	YES	6/6 Healthy	2016	2016	-	Serviceable	
9	220 kV Bay 9 Fdr no. 83		30000158	YES	6/6 Healthy	2016	2016	-	Serviceable	
10	220 kV Bay 10 Fdr no. 885		300001	YES	6/6 Healthy	2016	2016	-	Serviceable	
11	220 kV Bay 11 Fdr no. 81		30000163	YES	6/6 Healthy	2016	2016	-	Serviceable	
12	220 kV Bay 13 Fdr no. 86	CGL, 200-SFM-40A	2250-C	YES	6/6 Healthy	2002	Managed by HPSEB	20.76	Serviceable	The opening time is well within the limit and performance of CB is satisfactory.
13	220 kV Bay 14 Fdr no. 88		13316-C	YES	6/6 Healthy	2002		22	Serviceable	

<b>132 kV System</b>										
<b>B</b>										
1	132 kV Bay 12 Feeder no. 785	ABB, LTB145 D1/B	19002376	YES	6/6 Healthy	2016	2016	-	Serviceable	CB commissioned in the year 2016 and all the tests were conducted during commissioning. Performance of the CB is satisfactory.

<b>DC Supply</b>				
<b>Sl. no</b>	<b>Name</b>	<b>Date of Commission</b>	<b>Last testing</b>	<b>Remarks</b>
1	220/110 V DC-1	2007	13/12/2018	The Performance of battery is satisfactory. It is suggested to extend the both 220V DC source to the switchyard for breaker operation.
2	220/110 V DC-2	2007	14/12/2018	
3	48 V DC-1	2008	30/07/2021	
4	48 V DC-2	-	-	

# Transmission Line Protection

Sl. no	Voltage	Name of Protection Line		Make & Model	Serial No	Functional	Date of last testing	Date of Commissioning	Remark
1	220 kV	Khodri - Chibro 1	MAIN 1	ABB & REL511	T0507007	YES	NOT TESTED	08.02.2006	Since the available protection relay has no provision for communication and time sync facility. It is suggested to replace with the latest numerical IEDs.
2		Khodri - Chibro 2		ABB & REL511	T0507008	YES	08.05.2010	03.03.2006	
3		Khodri - Sarawa		GE Multilin & D60N03HKHF8L H6DM67P67U6U WXX	AABC11000997	YES	NOT TESTED	23.01.2012	The available protection is latest numerical IED. Performance is satisfactory.
4		Khodri - Saharanpur 2		GE Multilin & D60N03HKHF8L H6DM67P67U6U WXX	AABC11000995	YES	NOT TESTED	12.02.2012	
5		Khodri - Jhajhra		GE Multilin & D60N03HKHF8L H6DM67P67U6U WXX	AABC11000996	YES	NOT TESTED	-	
6		Khodri - Mazri 1		GE Multilin & D60N03HKHF8L H6DM67P67U6U WXX	AABC11000994	YES	NOT TESTED	31.08.2012	
7		Khodri - Mazri 2		ABB & REL670	11725086	NO	NOT TESTED	-	
8	132 kV	Khodri - Dhakrani		English Electric & SSRR3V71FF19E D	M220979	YES	NOT TESTED	-	The available protection is electromechanical type. This needs to be upgraded with the latest numerical IED.

Sl. no	Voltage	Name of Protection Line		Make & Model	Serial No	Functional	Date of last testing	Date of Commissioning	Remark
1	220 kV	Khodri - Chibro 1	MAIN 2	ABB & REL521	T0449074	YES	NOT TESTED	2005-2006	This needs to be replaced. Since relay has no provision for communication and time sync facility.
2		Khodri - Chibro 2		ABB & REL521	T0449075	YES	NOT TESTED	2005-2006	
3		Khodri - Sarawa		Alstom & P44231AB6M055 OK	31914767/10/11	YES	NOT TESTED	23.01.2012	The available protection is latest numerical IED. Performance is satisfactory.
4		Khodri - Saharanpur 2		Alstom & P44231AB6M055 OK	31914769/10/11	YES	NOT TESTED	12.02.2012	
5		Khodri - Jhajhra		Alstom & P44231AB6M055 OK	31914766/10/11	YES	NOT TESTED	2012	
6		Khodri - Mazri 1		Alstom & P44231AB6M055 OK	31914768/10/11	YES	NOT TESTED	31.08.2012	
7		Khodri - Mazri 2		ABB & REL670		YES	NOT TESTED	2019	

# Transformer Protection

Sl. no	Transformer (ICT/GT/ST)	TYPE	Make and model	Serial No	Functional	Date of Testing	Date of Commissioning	Serviceable/ Non serviceable	OTI/WTI INDICATOR	Bucholtz/ PDR	Remarks
1	34 MVA GT 1	Differential	ABB & REG 670	1814015, 1814016	YES	28.11.22	20.07.18	Serviceable	Working	YES	Performance is satisfactory.
2	34 MVA GT 2			2231055, 2218001	YES	06.02.23	02.08.17	Serviceable	Working	YES	
3	35 MVA GT 3			2217002, 2217003	YES	18.03.23	05.01.23	Serviceable	Working	YES	
4	34 MVA GT 4			2001103, 2001104	YES	2023	22.01.21	Serviceable	Working	YES	
Sl. no	Transformer (ICT/GT/ST)	TYPE	Make and model	Serial No	Functional	Date of Testing	Date of Commissioning	Serviceable/ Non serviceable	Remarks		
1	34 MVA GT 1	BACK UP REF	ABB & REG 670	1814015, 1814016	YES	28.11.22	20.07.18	Serviceable	Performance is satisfactory.		
2	34 MVA GT 2			2231055, 2218001	YES	06.02.23	02.08.17	Serviceable			
3	35 MVA GT 3			2217002, 2217003	YES	18.03.23	05.01.23	Serviceable			
4	34 MVA GT 4			2001103, 2001104	YES	2023	22.01.21	Serviceable			

Sl. no	Transformer (ICT/GT/ST)	TYPE	Make and model	Serial No	Functional	Date of Testing	Date of Commissioning	Serviceable/ Non serviceable	Remarks
1	34 MVA GT 1	BACK UP OVER CURRENT	ABB & REG 670	1814015, 1814016	YES	28.11.22	20.07.18	Serviceable	Performance is satisfactory.
2	34 MVA GT 2			2231055, 2218001	YES	06.02.23	02.08.17	Serviceable	
3	35 MVA GT 3			2217002, 2217003	YES	18.03.23	05.01.23	Serviceable	
4	34 MVA GT 4			2001103, 2001104	YES	2023	22.01.21	Serviceable	
1	34 MVA GT 1	BACK UP OVER FLUX	ABB & REG 670	1814015, 1814016	YES	28.11.22	20.07.18	Serviceable	Performance is satisfactory.
2	34 MVA GT 2			2231055, 2218001	YES	06.02.23	02.08.17	Serviceable	
3	35 MVA GT 3			2217002, 2217003	YES	18.03.23	05.01.23	Serviceable	
4	34 MVA GT 4			2001103, 2001104	YES	2023	22.01.21	Serviceable	

Sl. no	Transformer	Vector Group	MVA capacity in MVA	Percentage Impedance	Rated kV in kV		CT ratio			Remarks
					HV	LV	HV	LV	NCT	
1	34 MVA GT 1	YNd11	34	13.7	230	11	800/1	2000/1	100/1	The data is used for the relay setting calculation and review.
2	34 MVA GT 2	YNd11	34	13.7	230	11	800/1	2000/1	100/1	
3	35 MVA GT 3	YNd11	34	13.7	230	11	800/1	2000/1	100/1	
4	34 MVA GT 4	YNd11	34	13.7	230	11	800/1	2000/1	100/1	

## Bus bar Protection

Sl no	Bus bar	Make and model	Serial number	Serviceable/ Non Serviceable	Stability check	Remarks
1	220 kV	English Electrical	M220917, M220916, M220915	Non Serviceable	Not done after commissioning	The available protection is electro-mechanical type and very old & trouble prone. This needs to be upgraded with the latest numerical IED.

# Auxiliary Systems

Sl. no	Auxiliary supply	Sources of Supply	Reliability of Supply	Average of Tripping Month	Remarks					
1	Supply 1	Station Auxiliary Transformer	100%	9	Performance is satisfactory.					
2	Supply 2	Unit Auxiliary Transformer	100%	-						
Sl. no	Supply	Make and model	Serial Number	Rating	Auto/Manual	Fuel Level	Date of last testing	Date of Commissioning	Serviceable / Non Serviceable	Remarks
1	DG set	Caterpillar	H5G00653, H5G00757	500kVA	Manual	Normal	21/07/2023	2016	Serviceable	Performance is satisfactory.



## SUMMARY & RECOMMENDATION

### Protection audit of 220kV Substation at 120MW Khodri Power House

1	<b>DC Supply</b>	The Performance of battery is satisfactory. It is suggested to extend the both 220V DC source to the switchyard for breaker operation.
2	<b>220kV Khodri - Chibro 1 &amp; Khodri - Chibro 2 (MAIN 1)</b>	Since the available distance protection relay has no provision for communication and time synchronization facility. It is recommended to replace with the latest numerical IEDs.
3	<b>132kV Khodri - Dhakrani (MAIN 1)</b>	The available distance protection is electromechanical type. It is recommended to replace with the latest numerical IEDs.
4	<b>220kV Khodri - Chibro 1 &amp; Khodri - Chibro 2 (MAIN 2)</b>	Since the available distance protection relay has no provision for communication and time synchronization facility. It is recommended to replace with the latest numerical IEDs..
5	<b>220kV/132kV Busbar</b>	<p>The available differential protection is electro-mechanical type and very old &amp; trouble prone.</p> <p>For the fault on 11.09.2022, the unit 3, R-phase CB blasted. The bus bar protection not operated but the breaker at far end got tripped. So it was found that bus bar protection is not healthy and M/s UJVNL tried to rectify with OEM and found that spares are not available.</p> <p>It is found that, the 132kV line side, breaker is not available and hence for any fault at 132kV side, the network of 33kV is getting isolated and solar power integrated at 33kV is unable to evacuate power resulting in generation loss. Also, in case of fault, shutdown and maintenance, the breaker operation is being done from remote end, hence 132kV breaker is recommended.</p>

		<p>The following relays needs to be upgraded with the latest numerical IEDs</p> <ul style="list-style-type: none"> <li>❖ Bus bar protection <ul style="list-style-type: none"> <li>➤ Bus bar super vison relay type VTX 95A, 95B, 95CH;</li> <li>➤ Differential Protection 87A, 87B, 87CH,</li> <li>➤ Auxiliary relays 95AX, 95BX, 95CHX</li> <li>➤ Trip circuit supervision relays 95AY, 95BY, 95CHY</li> <li>➤ Interlock over current relay 51B1</li> <li>➤ Tripping Relay: 13 No. (96A, 96B, 96C to 96H)</li> </ul> </li> <li>❖ Synchronizing relay need to be installed.</li> <li>❖ Bay control unit is not available in the substation and need to be installed.</li> </ul>
6	<b>Khodri – Chibro line</b>	It is observed that the PLCC on Khodri - Chibro lines for tandem operation of generators which was commissioned in 2005-06 is obsolete and spares are not available. It is very much important to have a healthy PLCC communication for tandem operation and needs to be replaced.
7	<b>Transformer</b>	It is observed that the oil leakage is present in the 100 MVA 220/132 kV transformer in switchyard and this needs to be attended at the earliest.
8	<b>Testing</b>	It is recommended that all the CT, CVT, PT,CB and Numerical Protection IEDs shall be tested once in 3/4/5 years.
9	<b>Calibration</b>	It is recommended that Relay Test System and other testing equipment must be calibrated from NABL Accredited Laboratory
10	<b>Testing equipment</b>	It is recommended that the testing equipment such as tan delta kit, secondary injection kit, leakage current tester, power analyzer, winding resistance, TTR meter, energy meter testing is required at Khodri power house site for periodic testing and fault analysis.

New AC Lines Report from 01-11-2024 to 30-11-2024

S.No	CASE ID	Applicant Name	Name of element	Owner	Voltage Level (in KV)	Circuit No.	Line Length	Conductor Type	Tower Configuration	State	Approved In POC/Service Body	Remark	Initiation Request for charging of new element (Form-A)		Acknowledgment sent by RSCD (Form-B)		Request for test charging and trial run (Form-C)		Professional Approval for Test Charging (Form-D)		Request for Trial Operation Certificate (Form-E)		Trial Run Operation Certificate Details		
													Date	Time	Date	Time	Date	Time	Date	Time	Date	Time	Date	Time	Date
							Total Line Length:12 kms, Overhead: 5.5 km & Underground:6.5 kms	AL30 Zebra	Double	RAJASTHAN to RAJASTHAN	01-09-2024 - 11:00, 2nd NPCTP Meeting, Annex V/7table 2/75, 55			14 Nov 2024 20:53	20 Nov 2024 14:40	20 Nov 2024 20:05	26 Nov 2024 20:17	27 Nov 2024	23:10						
1	1119329	Nov_2024	220KV AGE24(Bhimsar)5L_Pg2_PG Farabgarh_8P5G.1	AGE2R	220KV		Total Line Length:12 kms, Overhead: 5.5 km & Underground:6.5 kms	AL30 Zebra	Double	RAJASTHAN to RAJASTHAN	01-09-2024 - 11:00, 2nd NPCTP Meeting, Annex V/7table 2/75, 55			14 Nov 2024 20:53	20 Nov 2024 14:40	20 Nov 2024 20:05	26 Nov 2024 20:17	27 Nov 2024	23:10						
2	1119330	Nov_2024	220KV AGE24(Bhimsar)5L_Pg2_PG Farabgarh_8P5G.2	AGE2R	220KV		Total Line Length:12 kms, Overhead: 5.5 km & Underground:6.5 kms	AL30 Zebra	Double	RAJASTHAN to RAJASTHAN	01-09-2024 - 11:00, 2nd NPCTP Meeting, Annex V/7table 2/75, 55			14 Nov 2024 20:53	20 Nov 2024 14:40	20 Nov 2024 20:05	26 Nov 2024 20:17	27 Nov 2024	23:30						

Bays Report from 01-11-2024 to 30-11-2024

S.No	CASE ID	Applicatio n Month	Name of element	Owner	Voltage Level (in KV)	Bay No	Bay Type	Substation	State	Approved by SCML/Statute Body	Remarks	Information request for charging of new element (Formwork)		Acknowledgment sent by NREDC (Format 1)		Request for test charging and trial run (Formwork)		Approval for Test Charging/Trial operations (Format 1)		Actual date & time of charging		Request for Trial Operation Certificate (Format 1)		Trial Run Operation Certificate Details		
												Date	Date	Date	Date	Date	Time	Date	Time	Date	Time	Date	Time	Date	Time	
1	111024	Jan-2024	400V Main Bay #12 of 411- Trn Bay of Nalanda (PSTCL) Mahan (PSTCL) CH and Future CT Bay at Nalanda (PSTCL) and Mahan (PSTCL)	PSTCL	400KV	412	Main Bay	Nalanda (PSTCL)	JHARKHAND			24-02-2023-10:00, R is already informed to CTU and CAPES, NA, MA.	18 Jan 2024 16:34	22 Jan 2024 08:16	25 Oct 2024 14:27, 18 Oct 2024 16:46	28 Oct 2024 12:29, 22 Oct 2024 10:04	27-Nov-2024	20:28								
2	111027	Oct-2024	400V Main Bay 437 of 400/220 KV, 500 MVA CT-5 at Bikaner_2 (PSTCL)	PSTCL	400KV	427	Main Bay	Bikaner_2 (PSTCL)	RAJASTHAN			18-09-2022-10:30, 9, 4, 5.2 point no.9, 19	19 Oct 2024 13:31, 16 Oct 2024 12:44	19 Oct 2024 14:17, 29 Oct 2024 10:33	20 Nov 2024 16:44	22 Nov 2024 11:49	23-Nov-2024	00:44	02 Dec 2024 00:58			27-11-2024-01:00 to 28-11-2024-01:00				
3	111027	Oct-2024	400V Trn Bay 426 of 400/220 KV, 500 MVA CT-5, and Future line at Bikaner_2 (PSTCL)	PSTCL	400KV	426	Trn Bay	Bikaner_2 (PSTCL)	RAJASTHAN			28-09-2022-10:30, 9, 4, 5.2 point no.9, 19	29 Oct 2024 13:31, 26 Oct 2024 12:44	29 Oct 2024 14:17, 29 Oct 2024 10:33	20 Nov 2024 16:44	22 Nov 2024 11:49	23-Nov-2024	00:49	02 Dec 2024 00:58			27-11-2024-01:00 to 28-11-2024-01:00				
4	111027	Oct-2024	220KV Main Bay 210 of 400/220 KV, 500 MVA CT-5, at Bikaner_2 (PSTCL)	PSTCL	220KV	210	Main Bay	Bikaner_2 (PSTCL)	RAJASTHAN			28-09-2022-10:30, 9, 4, 5.2 point no.9, 19	29 Oct 2024 13:31, 26 Oct 2024 12:44	29 Oct 2024 14:17, 29 Oct 2024 10:33	20 Nov 2024 16:44	22 Nov 2024 11:49	23-Nov-2024	18:24	02 Dec 2024 00:58			27-11-2024-01:00 to 28-11-2024-01:00				
5	111030	Nov-2024	220KV Main Bay 240A2 (01) of 220 KV Adani Renewable Energy Holding Four (01) at Fatahgarh (RPSG)	POWERGR D	220KV	240A2(01)	Main Bay	Fatahgarh (RPSG)	RAJASTHAN			13-09-2019-10:30, 5, 2, 20400_5	20 Nov 2024 17:59	22 Nov 2024 11:35	26 Nov 2024 16:48, 23 Nov 2024 21:49	26 Nov 2024 20:16, 26 Nov 2024 12:10	27-Nov-2024	23:10								
6	111029	Nov-2024	220KV Main Bay 202 of 220 KV Fatahgarh (RPSG) 2 PG	AGE24L	220KV	202	Main Bay	AGE24L(Bhmar)SL_Flg 2 PG	RAJASTHAN			01-09-2020-11:00, 2nd NRPCTP Meeting_AnnexV/Tabla 2/79_16	14 Nov 2024 20:53	20 Nov 2024 14:40	20 Nov 2024 20:03	26 Nov 2024 20:17	27-Nov-2024	23:19								
7	111030	Nov-2024	220KV Main Bay 239A(09) of 220 KV Adani Renewable Energy Holding Four (01) at Fatahgarh (RPSG)	POWERGR D	220KV	239A(09)	Main Bay	Fatahgarh (RPSG)	RAJASTHAN			13-09-2019-10:30, 5, 2, 20400_5	20 Nov 2024 17:59	22 Nov 2024 11:35	26 Nov 2024 16:48, 23 Nov 2024 21:49	26 Nov 2024 20:16, 26 Nov 2024 12:10	27-Nov-2024	23:30								
8	111029	Nov-2024	220KV Main Bay 201 of 220 KV Fatahgarh (RPSG) 2 PG	AGE24L	220KV	201	Main Bay	AGE24L(Bhmar)SL_Flg 2 PG	RAJASTHAN			01-09-2020-11:00, 2nd NRPCTP Meeting_AnnexV/Tabla 2/79_16	14 Nov 2024 20:53	20 Nov 2024 14:40	20 Nov 2024 20:03	26 Nov 2024 20:17	28-Nov-2024	00:10								
9	111029	Nov-2024	220KV Main Bay 201 of CT-1 at AGE24L(Bhmar)SL_Flg 2 PG	AGE24L	220KV	201	Main Bay	AGE24L(Bhmar)SL_Flg 2 PG	RAJASTHAN			01-09-2020-11:00, 2nd NRPCTP Meeting_AnnexV/Tabla 2/79_16	14 Nov 2024 20:53	20 Nov 2024 14:40	20 Nov 2024 20:03	26 Nov 2024 20:17	28-Nov-2024	00:42								
10	111029	Nov-2024	220KV Main Bay 204 of CT-2 at AGE24L(Bhmar)SL_Flg 2 PG	AGE24L	220KV	204	Main Bay	AGE24L(Bhmar)SL_Flg 2 PG	RAJASTHAN			01-09-2020-11:00, 2nd NRPCTP Meeting_AnnexV/Tabla 2/79_16	14 Nov 2024 20:53	20 Nov 2024 14:40	20 Nov 2024 20:03	26 Nov 2024 20:17	28-Nov-2024	01:35								
11	111029	Nov-2024	18KV Main Bay 0202 of CT-1 at AGE24L(Bhmar)SL_Flg 2 PG	AGE24L	33KV	0202	Main Bay	AGE24L(Bhmar)SL_Flg 2 PG	RAJASTHAN			01-09-2020-11:00, 2nd NRPCTP Meeting_AnnexV/Tabla 2/79_16	16 Nov 2024 13:09	20 Nov 2024 14:40	20 Nov 2024 20:03	27 Nov 2024 15:28	28-Nov-2024	03:50								
12	111029	Nov-2024	18KV Main Bay 0202 of CT-2 at AGE24L(Bhmar)SL_Flg 2 PG	AGE24L	33KV	0202	Main Bay	AGE24L(Bhmar)SL_Flg 2 PG	RAJASTHAN			01-09-2020-11:00, 2nd NRPCTP Meeting_AnnexV/Tabla 2/79_16	16 Nov 2024 13:09	20 Nov 2024 14:40	20 Nov 2024 20:03	27 Nov 2024 15:28	28-Nov-2024	04:18								
13	111029	Nov-2024	18KV Main Bay 0218 of CT-1 at AGE24L(Bhmar)SL_Flg 2 PG	AGE24L	33KV	0218	Main Bay	AGE24L(Bhmar)SL_Flg 2 PG	RAJASTHAN			01-09-2020-11:00, 2nd NRPCTP Meeting_AnnexV/Tabla 2/79_16	16 Nov 2024 13:09	20 Nov 2024 14:40	20 Nov 2024 20:03	27 Nov 2024 15:28	28-Nov-2024	04:19								
14	111029	Nov-2024	18KV Main Bay 0402 of CT-1 at AGE24L(Bhmar)SL_Flg 2 PG	AGE24L	33KV	0402	Main Bay	AGE24L(Bhmar)SL_Flg 2 PG	RAJASTHAN			01-09-2020-11:00, 2nd NRPCTP Meeting_AnnexV/Tabla 2/79_16	16 Nov 2024 13:09	20 Nov 2024 14:40	20 Nov 2024 20:03	27 Nov 2024 15:28	28-Nov-2024	04:20								
15	111029	Nov-2024	18KV Main Bay 0318 of CT-1 at AGE24L(Bhmar)SL_Flg 2 PG	AGE24L	33KV	0318	Main Bay	AGE24L(Bhmar)SL_Flg 2 PG	RAJASTHAN			01-09-2020-11:00, 2nd NRPCTP Meeting_AnnexV/Tabla 2/79_16	16 Nov 2024 13:09	20 Nov 2024 14:40	20 Nov 2024 20:03	27 Nov 2024 15:28	28-Nov-2024	04:21								
16	111029	Nov-2024	18KV Main Bay 0318 of CT-1 at AGE24L(Bhmar)SL_Flg 2 PG	AGE24L	33KV	0318	Main Bay	AGE24L(Bhmar)SL_Flg 2 PG	RAJASTHAN			01-09-2020-11:00, 2nd NRPCTP Meeting_AnnexV/Tabla 2/79_16	16 Nov 2024 13:09	20 Nov 2024 14:40	20 Nov 2024 20:03	27 Nov 2024 15:28	28-Nov-2024	04:21								
17	111029	Nov-2024	18KV Main Bay 0204 of Auxiliary Transformer bay 01 at AGE24L(Bhmar)SL_Flg 2 PG	AGE24L	33KV	0204	Main Bay	AGE24L(Bhmar)SL_Flg 2 PG	RAJASTHAN			01-09-2020-11:00, 2nd NRPCTP Meeting_AnnexV/Tabla 2/79_16	16 Nov 2024 13:09	20 Nov 2024 14:40	20 Nov 2024 20:03	27 Nov 2024 15:28	28-Nov-2024	05:09								
18	111029	Nov-2024	18KV Main Bay 0202 of CT-1 at AGE24L(Bhmar)SL_Flg 2 PG	AGE24L	33KV	0202	Main Bay	AGE24L(Bhmar)SL_Flg 2 PG	RAJASTHAN			01-09-2020-11:00, 2nd NRPCTP Meeting_AnnexV/Tabla 2/79_16	16 Nov 2024 13:09	20 Nov 2024 14:40	20 Nov 2024 20:03	27 Nov 2024 15:28	28-Nov-2024	21:16								
19	111029	Nov-2024	18KV Main Bay 0218 of CT-1 at AGE24L(Bhmar)SL_Flg 2 PG	AGE24L	33KV	0218	Main Bay	AGE24L(Bhmar)SL_Flg 2 PG	RAJASTHAN			01-09-2020-11:00, 2nd NRPCTP Meeting_AnnexV/Tabla 2/79_16	16 Nov 2024 13:09	20 Nov 2024 14:40	20 Nov 2024 20:03	27 Nov 2024 15:28	28-Nov-2024	21:17								
20	111023	Aug-2024	400V Main Bay #10 (C40) of Generator Step-Up Transformer Substation at Tahiti (THDC)	Tahiti PSA	400KV	#10 (C10)	Main Bay	Tahiti (THDC)	UTTARANCHAL			30-05-2009-10:00, 27th, 9, 0, 10 of 41	15 Nov 2024 18:17, 10 Nov 2024 17:22	25 Nov 2024 14:53, 13 Nov 2024 12:48	27 Nov 2024 17:18, 26 Nov 2024 10:09	28 Nov 2024 14:57, 27 Nov 2024 17:14	30-Nov-2024	13:53								

Bus Coupler Report from 01-11-2024 to 30-11-2024

S.No	CASE ID	Applicatio n Month	Name of element	Owner	Voltage Level (in KV)	Associated Transmission Element1	Associated Transmission Element2	Substation	State	Approved in SCM/Authority Body	Remark	Intimation request for charging of new element (Form6)		Acknowledment sent by BRISDC (Format 8)	Request for test charging and trial run (Format9)	Provisional Approval for Test Charging/Trial operation/Formet 10	Actual date & time of charging		Request for Trial Operation Certificate/ Forma C1	Trial Run/Operation Certificate Details	
												Date	Date				Date	Time		Date	Period
1	1110292	Nov-2024	220V Bus Coupler Bay 205 of Bus-1 and Bus-2 at AGE246/Bharmar/SI_7f6 2_PG	AGE246	220KV	Bus-2	Bus-3	AGE246/Bharmar/SI_7f6 2_PG	RAJASTHAN	01-09-2020 - 11:00, 2nd NRPCTP Meeting_Annex/Tabla/2/735_15		14-Nov-2024 20:51	20-Nov-2024 14:40	20-Nov-2024 20:03	26-Nov-2024 20:17	28-Nov-2024 00:20					
2	1110293	Nov-2024	11KV Bus Coupler Bay 0210 of Bus-1 and Bus-2 at AGE246/Bharmar/SI_7f6 2_PG	AGE246	11KV	Bus-2	Bus-1	AGE246/Bharmar/SI_7f6 2_PG	RAJASTHAN	01-09-2020 - 11:00, 2nd NRPCTP Meeting_Annex/Tabla/2/735_15		16-Nov-2024 13:09	20-Nov-2024 14:40	20-Nov-2024 20:03	27-Nov-2024 15:28	28-Nov-2024 17:42					



Capacitor Bank Report from 01-11-2024 to 30-11-2024

S.No	Case ID	Approximate Month	Name of element	Owner	Voltage Level (in kV)	Type of Capacitor	Capacitor Bank No.	Sub Capacitor Bank Name/Rate	Capacitor MVAR Rating	State	Approved in SCOP/Status Rev	Remark	Intimation request for charging of new element (Remarks)		Acknowledgment sent by NESCO (Remarks)		Request for test charging and trial run (Remarks)		Provisional Approval for Test Charging/Trial operation(Remarks)		Actual date & time of charging		Request for Total Operation Certificate Form-C1		Total Run/Operation Period		Certificate No.
													Date	Date	Date	Date	Date	Time	Date	Time	Period	Details					
1	1110263	Oct - 2024	15kV Harmonic Filter Capacitor Bank, 9 MVAR(9) MVAR Filter Bank as per compliances related to Clause 8.1 Power Quality Norms. 150 MVAR Hi-pass Filter (20th Harmonic) with quality factor of 2, cut off frequency 500 Hz. Capacitor bank no-03 at Bay no. 03-011. SWGR-04 at ASG276, S, 8W1C2 PG	ASEZPL	33kV	Harmonic Filter Capacitor Bank	03 at Bay no. 03-011 SWGR-04	150 MVAR Filter Bank	9 to	TS				01-09-2024 - 11.00, 2nd NPCTP Meeting, Annex V/ Table 2/7, 36	18 Oct 2024 10:30, 16 Oct 2024 10:30	22 Oct 2024 10:29, 17 Oct 2024 10:29	08 Nov 2024 18:18, 28 Oct 2024 12:02	12 Nov 2024 09:46, 05 Nov 2024 08:47	13 Nov 2024	20:03							
2	1110263	Oct - 2024	15kV Harmonic Filter Capacitor Bank, 28 MVAR(28) MVAR Filter Bank as per compliances related to Clause 8.1 Power Quality Norms. 150 MVAR Hi-pass Filter (20th Harmonic) with quality factor of 2, cut off frequency 500 Hz. 3x10 Single tuned Filter (2nd Harmonic) with quality factor of 30, cut off frequency 200 Hz. Capacitor bank no-03 at Bay no. 04-011. SWGR-04 at ASG276, S, 8W1C2 PG	ASEZPL	33kV	Harmonic Filter Capacitor Bank	03 at Bay no. 04-011 SWGR-04	150 MVAR Filter Bank	18 to	TS				01-09-2024 - 11.00, 2nd NPCTP Meeting, Annex V/ Table 2/7, 36	18 Oct 2024 10:30, 16 Oct 2024 10:30	22 Oct 2024 10:29, 17 Oct 2024 10:29	08 Nov 2024 18:18, 28 Oct 2024 12:02	12 Nov 2024 09:46, 05 Nov 2024 08:47	13 Nov 2024	20:03							
3	1110263	Oct - 2024	15kV Harmonic Filter Capacitor Bank, 28 MVAR(28) MVAR Filter Bank as per compliances related to Clause 8.1 Power Quality Norms. 150 MVAR Hi-pass Filter (20th Harmonic) with quality factor of 2, cut off frequency 500 Hz. 150 MVAR Single tuned Filter (2nd Harmonic) with quality factor of 30, cut off frequency 200 Hz. Capacitor bank no-05 at Bay no. 03-011 SWGR-04 at ASG276, S, 8W1C2 PG	ASEZPL	33kV	Harmonic Filter Capacitor Bank	05 at Bay no. 03-011 SWGR-04	150 MVAR Filter Bank	18 to	TS				01-09-2024 - 11.00, 2nd NPCTP Meeting, Annex V/ Table 2/7, 36	18 Oct 2024 10:30, 16 Oct 2024 10:30	22 Oct 2024 10:29, 17 Oct 2024 10:29	08 Nov 2024 18:18, 28 Oct 2024 12:02	12 Nov 2024 09:46, 05 Nov 2024 08:47	13 Nov 2024	20:03							
4	1110263	Oct - 2024	15kV Harmonic Filter Capacitor Bank, 28 MVAR(28) MVAR Filter Bank as per compliances related to Clause 8.1 Power Quality Norms. 150 MVAR Hi-pass Filter (20th Harmonic) with quality factor of 2, cut off frequency 500 Hz. 150 MVAR Single tuned Filter (2nd Harmonic) with quality factor of 30, cut off frequency 200 Hz. Capacitor bank no-04 at Bay no. 04-011 SWGR-04 at ASG276, S, 8W1C2 PG	ASEZPL	33kV	Harmonic Filter Capacitor Bank	04 at Bay no. 04-011 SWGR-04	150 MVAR Filter Bank	18 to	TS				01-09-2024 - 11.00, 2nd NPCTP Meeting, Annex V/ Table 2/7, 36	18 Oct 2024 10:30, 16 Oct 2024 10:30	22 Oct 2024 10:29, 17 Oct 2024 10:29	08 Nov 2024 18:18, 28 Oct 2024 12:02	12 Nov 2024 09:46, 05 Nov 2024 08:47	13 Nov 2024	20:03							





Transformer Report from 01-11-2024 to 30-11-2024

Line #	Asset ID	Asset Name	Asset Type	Manufacturer	Model	Serial Number	Year	Month	Day	Location	Condition	Notes	Asset ID	Asset Name	Asset Type	Manufacturer	Model	Serial Number	Year	Month	Day	Location	Condition	Notes
1	000001	Transformer 1	Transformer	ABB	1000	1000001	2024	11	01	Location 1	Good	Notes for Transformer 1	000002	Transformer 2	Transformer	ABB	1000	1000002	2024	11	01	Location 2	Good	Notes for Transformer 2
2	000003	Transformer 3	Transformer	ABB	1000	1000003	2024	11	01	Location 3	Good	Notes for Transformer 3	000004	Transformer 4	Transformer	ABB	1000	1000004	2024	11	01	Location 4	Good	Notes for Transformer 4
3	000005	Transformer 5	Transformer	ABB	1000	1000005	2024	11	01	Location 5	Good	Notes for Transformer 5	000006	Transformer 6	Transformer	ABB	1000	1000006	2024	11	01	Location 6	Good	Notes for Transformer 6
4	000007	Transformer 7	Transformer	ABB	1000	1000007	2024	11	01	Location 7	Good	Notes for Transformer 7	000008	Transformer 8	Transformer	ABB	1000	1000008	2024	11	01	Location 8	Good	Notes for Transformer 8
5	000009	Transformer 9	Transformer	ABB	1000	1000009	2024	11	01	Location 9	Good	Notes for Transformer 9	000010	Transformer 10	Transformer	ABB	1000	1000010	2024	11	01	Location 10	Good	Notes for Transformer 10

**Fwd: Re: Tripping of every transmission line whenever Broken Conductor Alarm on 220kV feeder and loss of VT (in any of phase) at 220kV bus is observed simultaneously-reg.**

Annexure-A.X

**DK**

D K Meena <seo-nrpc@nic.in>

Mon, 02 Dec 2024 5:16:17 PM +0530 •

To "LokeshAgrawal" <lokesh.cea@gov.in>

महोदय / महोदया,

fna

भवदीय,  
डी.के. मीना  
निदेशक (प्रचालन एवं संरक्षण),  
उत्तर क्षेत्रीय विद्युत समिति  
विद्युत् मंत्रालय  
१८-शहीद जीत सिंह मार्ग, कटवरिया सराय  
नई दिल्ली - १६

==== Forwarded message =====

From: SE T&C Meerut <setncmrt@upptcl.org>

To: "SE (R&A)" <sera@upslidc.org>

Cc: <seo-nrpc@nic.in>

Date: Mon, 02 Dec 2024 15:48:21 +0530

Subject: Re: Tripping of every transmission line whenever Broken Conductor Alarm on 220kV feeder and loss of VT (in any of phase) at 220kV bus is observed simultaneously-reg.

==== Forwarded message =====

Dear Sir,  
With reference to above subject, it is to mention that the matter of enabling tripping on broken conductor for substations having two lines only, was discussed during 54th PSC meeting, however the committee could not reach on a consensus during the meet. During the discussion the undersigned has suggested following scheme,  
i. In case of S/S fed by only two lines, both lines' distance protection should be programmed for detection of loss of voltage (using undervoltage function 27) for detection of shutdown/breakdown  
ii. This loss of voltage output should be crosswired to binary input of other line distance protection.  
iii. Tripping on broken conductor on any line should take place only if the other line is showing loss of voltage.

Regards,  
P.K Mishra

On Mon, 2 Dec 2024 at 13:57, SE (R&A) <sera@upslidc.org> wrote:

----- Forwarded message -----

From: **Lokesh Agrawal** <lokesh.cea@gov.in>

Date: Mon, Dec 2, 2024 at 1:53 PM

Subject: Tripping of every transmission line whenever Broken Conductor Alarm on 220kV feeder and loss of VT (in any of phase) at 220kV bus is observed simultaneously-reg.

To: satyendra Kumar Dotan <skdotancea@nic.in>, Ishan Sharan <i.sharan@nic.in>, schakraborty <schakraborty@powergrid.in>, gunjanagrawal <gunjan.agrawal@powergrid.in>, scsaxena <scsaxena@grid-india.in>, somaralakra <somara.lakra@grid-india.in>, dmandal <dmandal@ntpc.co.in>, dirpc <dirpc@bbmb.nic.in>, rrsemwal <rrsemwal@thdc.co.in>, sjvncso <sjvn.cso@sjvn.nic.in>, hod-om-co <hod-om-co@nhpc.nic.in>, df <df@npcil.co.in>, rajeshsharma <rajeshsharma@npcil.co.in>, gmsldc

<[gmsldc@delhisldc.org](mailto:gmsldc@delhisldc.org)>, cesocomml <[cesocomml@hvpn.org.in](mailto:cesocomml@hvpn.org.in)>, celd <[ce.ld@rvpn.co.in](mailto:ce.ld@rvpn.co.in)>, sera <[sera@upsldc.org](mailto:sera@upsldc.org)>, anupam\_singh <[anupam\\_singh@ptcul.org](mailto:anupam_singh@ptcul.org)>, ce-sldc <[ce-sldc@punjabsldc.org](mailto:ce-sldc@punjabsldc.org)>, cehpsldc <[cehpsldc@gmail.com](mailto:cehpsldc@gmail.com)>, bharatgujardtl <[bharatgujardtl@gmail.com](mailto:bharatgujardtl@gmail.com)>  
Cc: Sh Singh <[ms-nrpc@nic.in](mailto:ms-nrpc@nic.in)>, Santosh Kumar <[seo-nrpc@nic.in](mailto:seo-nrpc@nic.in)>, Reeturaj Pandey <[pandeyr.cea@gov.in](mailto:pandeyr.cea@gov.in)>, Kaushik Panditrao <[kaushik.panditrao@gov.in](mailto:kaushik.panditrao@gov.in)>

महोदय/महोदया,

Reference is invited to agenda item no. **10 (Tripping of every transmission line whenever Broken Conductor Alarm on 220kV feeder and loss of VT (in any of phase) at 220kV bus is observed simultaneously** (agenda by RVPN)) discussed in the 54th Protection Sub-Committee meeting held on 25.11.2024.

After deliberation, MS, NRPC stated to ask the comments of utilities on the proposal of RVPN and the same may be again discussed in the next PSC meeting based on received inputs.

In view of above, it is requested to kindly send the comments/inputs/observations/suggestions for the above to further deliberate in the next PSC meeting scheduled on 20.12.2024.

सादर,  
लोकेश अग्रवाल,  
सहायक कार्यपालक अभियंता (संरक्षण),  
उत्तर क्षेत्रीय विद्युत् समिति सचिवालय,  
नई दिल्ली - 110016

--  
***Superintending Engineer ,  
Reliability & Ancillary, UPSLDC  
Gomti Nagar , Lucknow.***



**RE: Tripping of every transmission line whenever Broken Conductor Alarm on 220kV feeder and loss of VT (in any of phase) at 220kV bus is observed simultaneously-reg.**

au

aupadhyay.ltp@lpgcl.com

Tue, 03 Dec 2024 12:49:23 PM +0530 •

To "LokeshAgrawal" <lokesh.cea@gov.in>

Cc "ansar.ltp" <ansar.ltp@lpgcl.com>, "alokkumar.ltp" <alokkumar.ltp@lpgcl.com>, "sushantg.ltp" <sushantg.ltp@lpgcl.com>, "Sh V K Singh" <ms-nrpc@nic.in>, "Santosh Kumar" <seo-nrpc@nic.in>, "Reeturaj Pandey" <pandeyr.cea@gov.in>, "Kaushik Panditrao" <kaushik.panditrao@gov.in>

Tags Not in Contacts

Dear Sir,

Please find below our observations :

LPGCL Reply on BRC Tripping as per Reference is invited to RVPN agenda item no. 10 discussed in the 54th Protection Sub-Committee meeting held on 25.11.2024 at Jodhpur.

1. Sending end (i.e. Generating End) substations where multiple lines and Generating end Transformer are already connected, will not be experienced undervoltage during broken conductor condition, however when receiving end substation having only one single line as incoming (radial substation) will detect undervoltage during broken conductor and tripping is required to avoid the single phasing of transformer. Hence Generating end substation lines tripping on Broken conductor are not required until further co-ordination with Grid authority.
2. BRC logic is available in distance protection relay and generally selected bus voltage (two phase) will come to distance relay for synch purpose. For detecting undervoltage of both buses, we need to create logic in bus coupler relays where both the bus voltages (3ph) will come together and its should be provided in AND logic with fuse fail condition.
3. BRC tripping to be co-ordinated with auto recloser time. In case of radial substation, bus voltage will be experienced undervoltage during auto-recloser. To avoid mal operation of BRC, its time should be co-ordinated with AR close timing.
4. LPGCL agreed with RVPN, however feasibility inside the existing relay to be explored with relay OEM.

**LPGCL Suggested Tripping Logic**

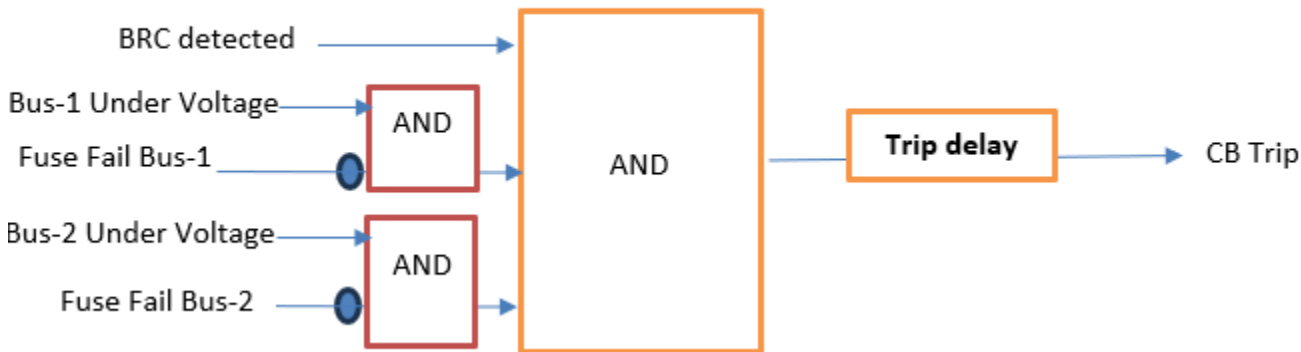

Thanks & Regards  
**Abhimanyu Upadhyay**  
General Manager-Electrical  
[aupadhyay.ltp@lpgcl.com](mailto:aupadhyay.ltp@lpgcl.com)

Lalitpur Power Generation Company Limited

Village Mirchwara Burogaon,

Tehsil Mehrauni, Lalitpur -284 123

Uttar Pradesh

P +917408418182/9151897271

[www.lpgcl.com](http://www.lpgcl.com)

---

**From:** Lokesh Agrawal <[lokesh.cea@gov.in](mailto:lokesh.cea@gov.in)>

**Sent:** 02 December 2024 13:54

**To:** navinchaturvedi <[navin.chaturvedi@apraava.com](mailto:navin.chaturvedi@apraava.com)>; VibhavAgarwal <[Vibhav.Agarwal@vedanta.co.in](mailto:Vibhav.Agarwal@vedanta.co.in)>; sknarang <[sk.narang@larsentoubro.com](mailto:sk.narang@larsentoubro.com)>; anandkumarsingh <[anandkumar.singh@meilanparapower.com](mailto:anandkumar.singh@meilanparapower.com)>; aruntholia <[arun.tholia@meilanparapower.com](mailto:arun.tholia@meilanparapower.com)>; kesarinandanpandey <[kesarinandan.pandey@relianceada.com](mailto:kesarinandan.pandey@relianceada.com)>; Alok Kumar Srivastava <[alokkumar.ltp@lpgcl.com](mailto:alokkumar.ltp@lpgcl.com)>; Abhimanyu Upadhyay <[aupadhyay.ltp@lpgcl.com](mailto:aupadhyay.ltp@lpgcl.com)>; SPSPUNDIR <[SPSPUNDIR@NTPC.CO.IN](mailto:SPSPUNDIR@NTPC.CO.IN)>; jayadebnanda <[jayadeb.nanda@adani.com](mailto:jayadeb.nanda@adani.com)>; jyotiprakashpanda <[jyotiprakash.panda@jsw.in](mailto:jyotiprakash.panda@jsw.in)>; dhmahabale <[dhmahabale@tatapower.com](mailto:dhmahabale@tatapower.com)>; cejkpcl2 <[cejkpcl2@gmail.com](mailto:cejkpcl2@gmail.com)>; cepdladakh <[cepdladakh@gmail.com](mailto:cepdladakh@gmail.com)>; elop2-chd <[elop2-chd@nic.in](mailto:elop2-chd@nic.in)>; ssvivastava <[ssrivastava@noidapower.com](mailto:ssrivastava@noidapower.com)>; SunilRaval <[Sunil.Raval@adani.com](mailto:Sunil.Raval@adani.com)>; ceonvvn <[ceonvvn@ntpc.co.in](mailto:ceonvvn@ntpc.co.in)>; sumant <[sumant@renew.com](mailto:sumant@renew.com)>; rajivgupta <[rajivgupta@ntpc.co.in](mailto:rajivgupta@ntpc.co.in)>; sunilgupta <[sunil.gupta@azurepower.com](mailto:sunil.gupta@azurepower.com)>; kishornair <[kishor.nair@avaada.com](mailto:kishor.nair@avaada.com)>; chaitanyasahoo <[chaitanya.sahoo@adani.com](mailto:chaitanya.sahoo@adani.com)>

**Cc:** Sh Singh <[ms-nrpc@nic.in](mailto:ms-nrpc@nic.in)>; Santosh Kumar <[seo-nrpc@nic.in](mailto:seo-nrpc@nic.in)>; Reeturaj Pandey <[pandeyr.cea@gov.in](mailto:pandeyr.cea@gov.in)>; Kaushik Panditrao <[kaushik.panditrao@gov.in](mailto:kaushik.panditrao@gov.in)>

**Subject:** Tripping of every transmission line whenever Broken Conductor Alarm on 220kV feeder and loss of VT (in any of phase) at 220kV bus is observed simultaneously-reg.

External Email | This message was sent from outside of Bajaj Group. Please treat hyperlinks and attachments in this email with caution.

महोदय/महोदया,

Reference is invited to agenda item no. **10 (Tripping of every transmission line whenever Broken Conductor Alarm on 220kV feeder and loss of VT (in any of phase) at 220kV bus is observed simultaneously** (agenda by RVPN)) discussed in the 54th Protection Sub-Committee meeting held on 25.11.2024.

After deliberation, MS, NRPC stated to ask the comments of utilities on the proposal of RVPN and the same may be again discussed in the next PSC meeting based on received inputs.

In view of above, it is requested to kindly send the comments/inputs/observations/suggestions for the above to further deliberate in the next PSC meeting scheduled on 20.12.2024.

सादर,  
लोकेश अग्रवाल,  
सहायक कार्यपालक अभियंता (संरक्षण),  
उत्तर क्षेत्रीय विद्युत् समिति सचिवालय,  
नई दिल्ली - 110016

---

===== Forwarded message =====

**From:** Lokesh Agrawal <[lokesh.cea@gov.in](mailto:lokesh.cea@gov.in)>

**To:** "cetspkl" <[cetspkl@hvpn.org.in](mailto:cetspkl@hvpn.org.in)>, "cemps" <[ce.mps@rvpn.co.in](mailto:ce.mps@rvpn.co.in)>, "md" <[md@upptcl.org](mailto:md@upptcl.org)>, "setandchld"

<setandchld@gmail.com>, "ce-pm"<ce-pm@pstcl.org>, "mdtcl"<md.tcl@hpmail.in>, "arifipgcl" <arif.ipgcl@gmail.com>, "semtrgtpp"<semt.rgtpp@hpgcl.org.in>, "cmd"<cmd@rrvun.com>, "ceppmm" <ce.ppmm@uprvunl.org>, "mdujvnl"<mdujvnl@ujvnl.com>, "md"<md@hppcl.in>, "ce-ghtp"<ce-ghtp@pspcl.in>, "md"<md@uhbvn.org.in>, "MDJDVVNL"<MD.JDVVNL@RAJASTHAN.GOV.IN>, "md" <md@pvvnl.org>, "md"<md@upcl.org>, "md"<md@hpseb.in>, "brahmajig"<brahmajig@ntpc.co.in>, "sanjay bhargava"<sanjay.bhargava@tatapower.com>, "dhananjay singh"<dhananjay.singh@ppgcl.co.in>  
Cc: "Sh Singh"<ms-nrpc@nic.in>, "Santosh Kumar"<seo-nrpc@nic.in>, "Reeturaj Pandey" <pandeyr.cea@gov.in>, "Kaushik Panditrao"<kaushik.panditrao@gov.in>

Date: Mon, 02 Dec 2024 13:52:49 +0530

Subject: Tripping of every transmission line whenever Broken Conductor Alarm on 220kV feeder and loss of VT (in any of phase) at 220kV bus is observed simultaneously-reg.

===== Forwarded message =====

महोदय/महोदया,

Reference is invited to agenda item no. **10 (Tripping of every transmission line whenever Broken Conductor Alarm on 220kV feeder and loss of VT (in any of phase) at 220kV bus is observed simultaneously** (agenda by RVPN)) discussed in the 54th Protection Sub-Committee meeting held on 25.11.2024.

After deliberation, MS, NRPC stated to ask the comments of utilities on the proposal of RVPN and the same may be again discussed in the next PSC meeting based on received inputs.

In view of above, it is requested to kindly send the comments/inputs/observations/suggestions for the above to further deliberate in the next PSC meeting scheduled on 20.12.2024.

सादर,  
लोकेश अग्रवाल,  
सहायक कार्यपालक अभियंता (संरक्षण),  
उत्तर क्षेत्रीय विद्युत् समिति सचिवालय,  
नई दिल्ली - 110016

===== Forwarded message =====

From: Lokesh Agrawal <lokesh.cea@gov.in>

To: "satyendra Kumar Dotan"<skdotancea@nic.in>, "Ishan Sharan"<i.sharan@nic.in>, "schakraborty"<schakraborty@powergrid.in>, "gunjan agrawal"<gunjan.agrawal@powergrid.in>, "scsaxena"<scsaxena@grid-india.in>, "somaralakra"<somara.lakra@grid-india.in>, "dmandal" <dmandal@ntpc.co.in>, "dirpc"<dirpc@bbmb.nic.in>, "rrsemwal"<rrsemwal@thdc.co.in>, "sjvncso"<sjvn.cso@sjvn.nic.in>, "hod-om-co"<hod-om-co@nhpc.nic.in>, "df"<df@npcil.co.in>, "rajeshsharma"<rajeshsharma@npcil.co.in>, "gmsldc"<gmsldc@delhisldc.org>, "cesocomml" <cesocomml@hvpn.org.in>, "celd"<ce.ld@rvpn.co.in>, "sera"<sera@upsldc.org>, "anupam\_singh"<anupam\_singh@ptcul.org>, "ce-sldc"<ce-sldc@punjabslidc.org>, "cehpsldc" <cehpsldc@gmail.com>, "bharatgujardtl"<bharatgujardtl@gmail.com>

Cc: "Sh Singh"<ms-nrpc@nic.in>, "Santosh Kumar"<seo-nrpc@nic.in>, "Reeturaj Pandey" <pandeyr.cea@gov.in>, "Kaushik Panditrao"<kaushik.panditrao@gov.in>

Date: Mon, 02 Dec 2024 13:51:43 +0530

Subject: Tripping of every transmission line whenever Broken Conductor Alarm on 220kV feeder

and loss of VT (in any of phase) at 220kV bus is observed simultaneously-reg.  
===== Forwarded message =====

महोदय/महोदया,

Reference is invited to agenda item no. **10 (Tripping of every transmission line whenever Broken Conductor Alarm on 220kV feeder and loss of VT (in any of phase) at 220kV bus is observed simultaneously** (agenda by RVPN)) discussed in the 54th Protection Sub-Committee meeting held on 25.11.2024.

After deliberation, MS, NRPC stated to ask the comments of utilities on the proposal of RVPN and the same may be again discussed in the next PSC meeting based on received inputs.

In view of above, it is requested to kindly send the comments/inputs/observations/suggestions for the above to further deliberate in the next PSC meeting scheduled on 20.12.2024.

सादर,  
लोकेश अग्रवाल,  
सहायक कार्यपालक अभियंता (संरक्षण),  
उत्तर क्षेत्रीय विद्युत् समिति सचिवालय,  
नई दिल्ली - 110016

---



## Urgent Attention Required: Frequent Tripping of UPPTCL 220 kV Transmission Lines Connected to GIS Baghpat

**From** Pankaj Kumar Jha {पंकज कुमार झा} <pankaj.jha@powergrid.in>

**Date** Fri 2024-11-29 13:50

**To** cetw@upptcl.org <cetw@upptcl.org>

**Cc** eeetdmrt@gmail.com <eeetdmrt@gmail.com>; eeetdbaraut@upptcl.org <eeetdbaraut@upptcl.org>; eeetdshamli@upptcl.org <eeetdshamli@upptcl.org>; eeetd1gzb@upptcl.org <eeetd1gzb@upptcl.org>; setmrt@upptcl.org <setmrt@upptcl.org>; setgzb@upptcl.org <setgzb@upptcl.org>; rtamc.nr1 <rtamc.nr1@powergrid.in>; dharmendra.cea@gov.in <dharmendra.cea@gov.in>; Reeturaj Pandey <pandeyr.cea@gov.in>; Sh Singh <ms-nrpc@nic.in>; Santosh Kumar <seo-nrpc@nic.in>; LokeshAgrawal <lokesh.cea@gov.in>; Kuleshwar Sahu {कुलेश्वर साहू} <kuleshwar@powergrid.in>; Neeraj Kumar {नीरज कुमार} <Neerajk@powergrid.in>; M Thirumala Reddy {एम. तिरूमाला रेड्डी} <thirumalareddy@powergrid.in>; Tarun Bajaj {तरुण बजाज} <tarunbajaj@powergrid.in>; Ravi Wadyalkar {रवि अशोक वाड्यालकर} <wravi@powergrid.in>; Ankit Vaish {अंकित वैश्य} <ankit\_vaish@powergrid.in>; ccprotection <ccprotection@powergrid.in>; deepak.kr@grid-india.in <deepak.kr@grid-india.in>

2 attachments (17 MB)

Email Communication with UPPTCL.pdf; Letter\_Frequent Trippings of 220kV Lines at Baghpat.pdf;

Dear Sir,

This refers to our previous communications regarding the frequent tripping/auto-reclosures of UPPTCL's 220 kV transmission lines connected to POWERGRID's GIS Baghpat. These lines are experiencing severe transient and permanent faults, posing significant operational hazards, as detailed below:

S.N.	Name of the Element	No. of Faults			
		CY'22	CY'23	CY'24	Total
1	220kV Baghpat (PG)-Shamli (UP) Line	37	23	24	84
2	220kV Baghpat (PG)-Mandola Vihar (UP) Line	18	11	9	38
3	220kV Baghpat (PG)-Baghpat(UP) Ckt-I	4	1	3	8
4	220kV Baghpat (PG)-Baghpat(UP) Ckt-II	14	6	3	23
5	220kV Baghpat (PG)-Modipuram(UP) Ckt-I	4	20	7	31
6	220kV Baghpat (PG)-Modipuram(UP) Ckt-II	3	10	5	18

Frequent tripping of UPPTCL transmission lines is causing heavy fault currents through POWERGRID's 400/220 kV ICTs and bay equipment at GIS Baghpat, significantly impacting equipment lifespan. These recurring faults have already led to the failure of a circuit breaker on the 220 kV Baghpat (PG)-Shamli (UP) line in August 2023, resulting in substantial financial losses and a prolonged outage.



Given that Baghpat substation uses advanced GIS technology with expensive equipment, such faults are unsustainable.

We request urgent remedial action, including thorough patrolling of the affected lines, to rectify defects and maintain system reliability.

**If this issue persists, POWERGRID will be forced to review its A/R settings to protect its equipment at Baghpat Substation.** We urge your team to prioritize this matter and take immediate corrective measures.

Looking forward to your prompt action.

Warm Regards

Pankaj Kumar Jha

Chief Manager (Asset Management)

Power Grid Corporation of India Limited

Regional Headquarters, Northern Region-1

SCO Bay No.5 -10, Sector-16A, Faridabad, Haryana-121002

Mob: +919634440125

Ref: NR-1/AM/

Dt. 29.11.2024

To,

**Chief Engineer (Transmission West, UPPTCL, Meerut)****Victoria Park, Ramgarhi, Meerut, Uttar Pradesh. Pin-250001****Subject: Frequent tripping of 220 kV Transmission Lines of UPPTCL connected to POWERGRID, GIS Baghpat.**

Dear Sir,

It is to inform that in recent past the 220 kV Transmission Lines of UPPTCL connected to POWERGRID, GIS Baghpat are tripping/auto-reclosing very frequently due to severe transient and permanent faults. **The transmission lines are proving to be dangerously hazardous as is evident from the data tabulated below:**

S.N.	Name of the Element	No. of Faults			
		CY'22	CY'23	CY'24	Total
1	220kV Baghpat (PG)-Shamli (UP) Line	37	23	24	84
2	220kV Baghpat (PG)-Mandola Vihar (UP) Line	18	11	9	38
3	220kV Baghpat (PG)-Baghpat (UP) Ckt-I	4	1	3	8
4	220kV Baghpat (PG)-Baghpat (UP) Ckt-II	14	6	3	23
5	220kV Baghpat (PG)-Modipuram (UP) Ckt-I	4	20	7	31
6	220kV Baghpat (PG)-Modipuram (UP) Ckt-II	3	10	5	18

You will appreciate that such occurrences result in problems for not just UPPTCL but POWERGRID and Outage Management Units as well.

You are already aware that such frequent unwarranted tripping of transmission lines results in flow of heavy fault current through connected 400/220 kV ICTs and other bay equipment at GIS Baghpat of POWERGRID, thus adversely affecting equipment life. **It is worth highlighting that these frequent faults causing tripping/auto-reclosure have already resulted in failure of circuit breaker of the bay connected to 220 kV Baghpat (PG)-Shamli (UP) transmission line in August 2023, thus resulting in heavy financial loss to**

**POWERGRID and long system outage.** POWERGRID substation at Baghpat is based on advance GIS technology loaded with expensive equipment and POWERGRID cannot afford such frequent feeding of severe fault current through its ICT & other equipment.

Considering the above-mentioned circumstances and already occurrence of a failure, **you are requested to kindly look into the matter on priority and arrange to take up necessary remedial action** including thorough patrolling of aforesaid lines **to ensure the rectification of defects and maintain healthiness of transmission system** elements installed at POWERGRID Baghpat GIS Station, so that uninterrupted power supply may be extended to UPPTCL substations.

In spite of our earlier requests to address this issue of frequent tripping/Autor reclosure, situation has not improved much in UPPTCL lines. It may please be noted that **POWERGRID shall be forced to review its A/R settings in case such frequent fault feeding is not arrested urgently from UPPTCL lines.** We trust that your team will prioritize this matter this time and take appropriate measures to address the ongoing challenges.

Looking forward for a prompt & positive action and continued support from your end.

  
**Kuleshwar Sahu**

**CGM-AM, NR1 Gr-1**

**Encl:** Line-wise tripping/AR list

- Copy to:**
1. Member Secretary, NRPC (E-mail: ms-nrpc@nic.in)
  2. SEO, NRPC (E-mail: seo-nrpc@nic.in)
  3. Executive Engineer, Electricity Transmission Circle – Meerut, UPPTCL  
(Email: eeetdmrt@gmail.com)
  4. Executive Engineer, Power Transmission Division – Baraut, UPPTCL  
(Email: eeetdbaraut@upptcl.org)
  5. Executive Engineer, 220 KV Sub-station, Shamli, UPPTCL  
(Email: eeetdshamli@upptcl.org)
  6. Executive Engineer, Electricity Transmission Division-I, Ghaziabad,  
UPPTCL (Email: eeetd1gzb@upptcl.org)

**Copy for kind information:**

1. Executive Director (NR-1), POWERGRID
2. CGM-I/C CC-AM, POWERGRID

<u>220 kV Baghpat-Shamli Line</u>				
<u>Tripping &amp; A/R Details</u>				
S.No.	Date	Fault Details		Category
		M1	M2	
1	14-Nov-24	Phase- B-G	Phase- L3-N	A/R
		Distance- 9.2Km	Distance- 9.2Km	
		<b>Current- 9.4 KA</b>	<b>Current- 9.402KA</b>	
		Zone-1	Zone-1	
2	14-Nov-24	Phase- B-G	Phase- L3-N	A/R
		Distance- 5.0Km	Distance- 5.0Km	
		<b>Current- 12.76 KA</b>	<b>Current- 12.856KA</b>	
		Zone-1	Zone-1	
3	17-Oct-24	Phase- Y-G	Phase- L2-N	TRIP
		Distance- 12.7Km	Distance- 12.6Km	
		<b>Current- 7.76 KA</b>	<b>Current- 7.807KA</b>	
		Zone-1	Zone-1	
4	4-Oct-24	Phase- B-G	Phase- L3-N	TRIP
		Distance- 9.1Km	Distance- 9.0Km	
		<b>Current- 9.47 KA</b>	<b>Current- 09.455KA</b>	
		Zone-1	Zone-1	
5	29-Sep-24	Phase- Y-G	Phase- L2-N	TRIP
		Distance- 3.2Km	Distance- 3.9Km	
		<b>Current- 14.33 KA</b>	<b>Current- 14.338KA</b>	
		Zone-1	Zone-1	
6	13-Sep-24	Phase- R-G	Phase- L1-N	TRIP
		Distance- 1.2Km	Distance- 1.2Km	
		<b>Current- 19.14 KA</b>	<b>Current- 19.31 KA</b>	
		Zone-1	Zone-1	
7	25-Aug-24	Phase- Y-G	Phase- L2-N	TRIP
		Distance- 2.4Km	Distance- 2.4Km	
		<b>Current- 17.29 KA</b>	<b>Current- 17.25 KA</b>	
		Zone-1	Zone-1	
8	29-Jul-24	Phase- Y-G	Phase- L2-N	TRIP
		Distance- 17.0 Km	Distance-17.0Km	
		<b>Current- 6.25 KA</b>	<b>Current- 6.25 KA</b>	
		Zone-1	Zone-1	
9	24-Jul-24	Phase- B-G	Phase- L3-N	TRIP
		Distance- 1.4 Km	Distance- 1.4 Km	
		<b>Current- 19.10 KA</b>	<b>Current- 19.016 KA</b>	
		Zone-1	Zone-1	
10	14-Jul-24	Phase- B-G	Phase- L3-N	TRIP
		Distance- 7.9 Km	Distance- 7.9 Km	
		<b>Current- 9.97 KA</b>	<b>Current- 10.014 KA</b>	
		Zone-1	Zone-1	
11	28-May-24	Phase- B-G	Phase- L3-N	TRIP
		Distance- 32.8 Km	Distance- 33.0 Km	
		<b>Current- 4.22 KA</b>	<b>Current- 4.21 KA</b>	
		Zone-1	Zone-1	
12	28-May-24	Phase- B-G	Phase- L3-N	TRIP
		Distance- 33.5 Km	Distance- 34.7 Km	
		<b>Current- 4.13 KA</b>	<b>Current- 4.091 KA</b>	
		Zone-1	Zone-1	

<u>220 kV Baghpat-Shamli Line</u>				
<u>Tripping &amp; A/R Details</u>				
S.No.	Date	Fault Details		Category
		M1	M2	
13	27-May-24	Phase- B-G	Phase- L3-N	TRIP
		Distance- 33.3 Km	Distance- 33.3 Km	
		<b>Current- 4.45 KA</b>	<b>Current- 4.502 KA</b>	
		Zone-1	Zone-1	
14	17-May-24	Phase- Y-B	Phase- L2-L3	TRIP
		Distance- 38.06 Km	Distance- 38.8 Km	
		<b>Current- 5.07KA, 5.06KA</b>	<b>Current- 5.277KA, 4.649KA</b>	
		Zone-2	Zone-2	
15	12-May-24	Phase- R-G	Phase- L1-N	TRIP
		Distance- 4.00 Km	Distance- 3.9 Km	
		<b>Current- 10.99 KA</b>	<b>Current- 12.130 KA</b>	
		Zone-1	Zone-1	
16	12-May-24	Phase- R-G	Phase- L1-N	TRIP
		Distance- 4.1 Km	Distance- 4.00 Km	
		<b>Current- 9.11 KA</b>	<b>Current- 10.767 KA</b>	
		Zone-1	Zone-1	
17	6-May-24	Phase- R-G	Phase- L1-N	TRIP
		Distance- 3.6 Km	Distance-3.81 Km	
		<b>Current- 12.50 KA</b>	<b>Current- 12.563 KA</b>	
		Zone-1	Zone-1	
18	4-May-24	Phase- B-G	Phase- L3-N	TRIP
		Distance- 32.1 Km	Distance- 32.3 Km	
		<b>Current- 4.09 KA</b>	<b>Current- 4.12 KA</b>	
		Zone-1	Zone-1	
19	28-Apr-24	Phase- R-G	Phase- L1-N	TRIP
		Distance- 4.00 Km	Distance-3.9 Km	
		<b>Current- 9.62 KA</b>	<b>Current- 11.369 KA</b>	
		Zone-1	Zone-1	
20	26-Apr-24	Phase- B-G	Phase- L3-N	TRIP
		Distance- 31.9 Km	Distance-31.7Km	
		<b>Current- 4.07 KA</b>	<b>Current- 4.103 KA</b>	
		Zone-1	Zone-1	
21	18-Apr-24	Phase- B-G	Phase- L3-N	TRIP
		Distance- 9.2 Km	Distance-9.1 Km	
		<b>Current- 8.35 KA</b>	<b>Current- 8.894 KA</b>	
		Zone-1	Zone-1	
22	15-Apr-24	Phase- R-G	Phase- L1-N	TRIP
		Distance- 127.1 Km	Distance-6.1 Km	
		<b>Current- 11.13 KA</b>	<b>Current- 10.94 KA</b>	
		Zone-1	Zone-1	
23	12-Apr-24	Phase- B-G	Phase- L3-N	TRIP
		Distance- 11.2 Km	Distance-11.22 Km	
		<b>Current- 7.99 KA</b>	<b>Current- 7.83 KA</b>	
		Zone-1	Zone-1	
24	29-Mar-24	Phase- Y-G	Phase- L2-N	TRIP
		Distance- 32.6.2 Km	Distance-32.7 Km	
		<b>Current- 4.21 KA</b>	<b>Current- 4.254 KA</b>	
		Zone-1	Zone-1	



<u>220 kV Baghpat-Shamli Line</u>				
<u>Tripping &amp; A/R Details</u>				
S.No.	Date	Fault Details		Category
		M1	M2	
25	26-Dec-23	Phase- B-G	Phase- L2-N	TRIP
		Distance- 31.8 Km	Distance-30.6 Km	
		<b>Current- 3.57 KA</b>	<b>Current- 3.585 KA</b>	
		Zone-1	Zone-1	
26	8-Dec-23	Phase- R-G	Phase- L1-N	A/R
		Distance- 6.2 Km	Distance-6.1 Km	
		<b>Current- 11.13 KA</b>	<b>Current-10.94 KA</b>	
		Zone-1	Zone-1	
27	24-Nov-23	Phase- R-G	Phase- L1-N	A/R
		Distance- 9.8 Km	Distance-9.6 Km	
		<b>Current- 8.01 KA</b>	<b>Current- 8.80 KA</b>	
		Zone-1	Zone-1	
28	15-Nov-23	Phase- R-G	Phase- L1-N	A/R
		Distance- 5.6 Km	Distance-5.56 Km	
		<b>Current- 11.49 KA</b>	<b>Current- 11.63 KA</b>	
		Zone-1	Zone-1	
29	4-Nov-23	Phase- Y-G	Phase- L2-N	A/R
		Distance- 5.2 Km	Distance-5.2 Km	
		<b>Current- 11.39 KA</b>	<b>Current- 12.050 KA</b>	
		Zone-1	Zone-1	
30	17-Oct-23	Phase- Y-G	Phase- L2-N	A/R
		Distance- 20.5 Km	Distance-20.52 Km	
		<b>Current- 5.32 KA</b>	<b>Current- 5.341 KA</b>	
		Zone-1	Zone-1	
31	17-Oct-23	Phase- Y-G	Phase- L2-N	A/R
		Distance- 20.5 Km	Distance-20.52 Km	
		<b>Current- 5.32 KA</b>	<b>Current- 5.341 KA</b>	
		Zone-1	Zone-1	
32	17-Oct-23	Phase- Y-G	Phase- L2-N	A/R
		Distance- 20.5 Km	Distance-20.52 Km	
		<b>Current- 5.32 KA</b>	<b>Current- 5.341 KA</b>	
		Zone-1	Zone-1	
33	7-Sep-23	Phase- R-G	Phase- L1-N	TRIP
		Distance- 3.8 Km	Distance-3.8 Km	
		<b>Current- 9.45 KA</b>	<b>Current- 10.731 KA</b>	
		Zone-1	Zone-1	
34	6-Sep-23	Phase- R-G	Phase- L1-N	TRIP
		Distance- 3.9 Km	Distance-3.9 Km	
		<b>Current- 12.84 KA</b>	<b>Current- 12.462 KA</b>	
		Zone-1	Zone-1	
35	5-Sep-23	Phase- B-G	Phase- L3-N	TRIP
		Distance- 32.2 Km	Distance-37.3 Km	
		<b>Current- 4.01 KA</b>	<b>Current- 4.017 KA</b>	
		Zone-1	Zone-1	
36	27-Aug-23	Phase- Y-G	Phase- L2-N	A/R
		Distance- 2.4 Km	Distance-2.4 Km	
		<b>Current- 15.53 KA</b>	<b>Current- 15.305 KA</b>	
		Zone-1	Zone-1	

<b>220 kV Baghpat-Shamli Line</b>				
<b>Tripping &amp; A/R Details</b>				
S.No.	Date	Fault Details		Category
		M1	M2	
37	3-Aug-23	Phase- B-G	Phase- L3-N	TRIP
		Distance- 6.9 Km	Distance-7.0 Km	
		<b>Current- 9.68 KA</b>	<b>Current- 10.308 KA</b>	
		Zone-1	Zone-1	
38	17-Jul-23	Phase- Y-G	Phase- L2-N	TRIP
		Distance- 37.3 Km	Distance-37.5 Km	
		<b>Current- 4.06 KA</b>	<b>Current- 4.331 KA</b>	
		Zone-2	Zone-2	
39	15-Jul-23	Phase- Y-G	Phase- L2-N	A/R
		Distance- 20.6 Km	Distance-20.7 Km	
		<b>Current- 6.55 KA</b>	<b>Current- 6.45 KA</b>	
		Zone-1	Zone-1	
40	9-Jul-23	Phase- Y-G	Phase- L2-N	A/R
		Distance- 21.1 Km	Distance-21.085 Km	
		<b>Current- 6.13 KA</b>	<b>Current- 6.36 KA</b>	
		Zone-1	Zone-1	
41	8-Jul-23	Phase- Y-G	Phase- L2-N	A/R
		Distance- 12.1 Km	Distance-12.08 Km	
		<b>Current- 9.06 KA</b>	<b>Current- 8.88 KA</b>	
		Zone-1	Zone-1	
42	8-Jul-23	Phase- R-G	Phase- L1-N	A/R
		Distance- 34.1 Km	Distance-33.9 Km	
		<b>Current- 4.60 KA</b>	<b>Current- 4.70 KA</b>	
		Zone-1	Zone-1	
43	8-Jul-23	Phase- Y-G	Phase- L2-N	A/R
		Distance- 19.3 Km	Distance-19.1 Km	
		<b>Current- 6.56 KA</b>	<b>Current- 6.87 KA</b>	
		Zone-1	Zone-1	
44	22-Jun-23	Phase- B-G	Phase- L3-N	A/R
		Distance- 14.5 Km	Distance-14.61 Km	
		<b>Current- 7.93 KA</b>	<b>Current- 7.907 KA</b>	
		Zone-1	Zone-1	
45	18-Jun-23	Phase- Y-G	Phase- L2-N	A/R
		Distance- 14.5 Km	Distance-14.5 Km	
		<b>Current- 8.00 KA</b>	<b>Current- 8.05 KA</b>	
		Zone-1	Zone-1	
46	21-May-23	Phase- NIL	Phase- L1-N	A/R
		Distance- NIL	Distance-34.48 Km	
		<b>Current- NIL</b>	<b>Current- 3.70 KA</b>	
		Zone- NIL	Zone-2	
47	20-May-23	Phase- R-G	Phase- L1-N	TRIP
		Distance- 40.9 Km	Distance-41.26Km	
		<b>Current- 3.92 KA</b>	<b>Current- 4.17 KA</b>	
		Zone-2	Zone-2	
48	13-Nov-22	Phase- B-G	Phase- L3-N	A/R
		Distance- 9.2 Km	Distance-9.2 Km	
		<b>Current- 11.35 KA</b>	<b>Current - 11.14 KA</b>	
		Zone-1	Zone-1	

<u>220 kV Baghpat-Shamli Line</u>				
<u>Tripping &amp; A/R Details</u>				
S.No.	Date	Fault Details		Category
		M1	M2	
49	8-Nov-22	Phase- Y-G	Phase- L2-N	A/R
		Distance- 1.2 Km	Distance-1.3 Km	
		<b>Current- 19.94 KA</b>	<b>Current- 21.2 KA</b>	
		Zone-1	Zone-1	
50	3-Nov-22	Phase- R-G	Phase- L1-N	A/R
		Distance- 12.4 Km	Distance-12.3 Km	
		<b>Current- 9.02 KA</b>	<b>Current- 9.42 KA</b>	
		Zone-1	Zone-1	
51	31-Oct-22	Phase- Y-G	Phase- L2-N	A/R
		Distance- 5.6 Km	Distance-5.7 Km	
		<b>Current- 13.77 KA</b>	<b>Current- 13.98 KA</b>	
		Zone-1	Zone-1	
52	19-Oct-22	Phase- Y-G	Phase- L2-N	A/R
		Distance- 14.2Km	Distance-13.9Km	
		<b>Current- 8.08 KA</b>	<b>Current- 8.855KA</b>	
		Zone-1	Zone-1	
53	19-Oct-22	Phase- Y-G	Phase- L2-N	A/R
		Distance- 35.4Km	Distance-35.6Km	
		Current- 4.65 KA	Current- 4.685KA	
		Zone-1	Zone-1	
54	19-Oct-22	Phase- Y-G	Phase- L2-N	A/R
		Distance- 23.8Km	Distance-23.5Km	
		Current- 5.76 KA	Current- 6.16 KA	
		Zone-1	Zone-1	
55	18-Oct-22	Phase- B-G	Phase- L3-N	A/R
		Distance- 4.5 Km	Distance-4.6 Km	
		<b>Current- 13.74 KA</b>	<b>Current- 14.75 KA</b>	
		Zone-1	Zone-1	
56	16-Oct-22	Phase- R-G	Phase- L1-N	A/R
		Distance- 34.8 Km	Distance-34.5Km	
		Current- 4.58 KA	Current- 4.64 KA	
		Zone-1	Zone-1	
57	14-Oct-22	Phase- B-G	Phase- L3-N	A/R
		Distance- 3.2 Km	Distance- 3.3Km	
		<b>Current- 17.11 KA</b>	<b>Current- 16.836 KA</b>	
		Zone-1	Zone-1	
58	5-Oct-22	Phase- Y-G	Phase- L2-N	A/R
		Distance- 17.2 Km	Distance-17.00Km	
		Current- 7.71 KA	Current- 7.77 KA	
		Zone-1	Zone-1	
59	24-Sep-22	Phase- Y-G	Phase- L2-N	A/R
		Distance- 30.00Km	Distance- 30Km	
		Current- 5.24 KA	Current- 5.283 KA	
		Zone-1	Zone-1	
60	16-Sep-22	Phase- Y-G	Phase- L2-N	A/R
		Distance- 35.00 Km	Distance-35.00Km	
		Current- 4.74 KA	Current- 5.461KA	
		Zone-1	Zone-1	



220 kV Baghpat-Shamli Line				
Tripping & A/R Details				
S.No.	Date	Fault Details		Category
		M1	M2	
61	31-Aug-22	Phase- B-G	Phase- L3-N	A/R
		Distance- 10.5 Km	Distance-10.4Km	
		Current- 10.2 KA	Current- 10.13 KA	
		Zone-1	Zone-1	
62	30-Aug-22	Phase- B-G	Phase- L3-N	A/R
		Distance- 10.6 Km	Distance-10.5Km	
		Current- 10.14 KA	Current- 10.13 KA	
		Zone-1	Zone-1	
63	30-Aug-22	Phase- B-G	Phase- L3-N	A/R
		Distance- 10.5 Km	Distance-10.51Km	
		Current- 10.20KA	Current- 10.23 KA	
		Zone-1	Zone-1	
64	24-Aug-22	Phase- R-G	Phase- L1-N	A/R
		Distance- 10.4 Km	Distance-10.3Km	
		Current- 10.24 KA	Current- 10.342 KA	
		Zone-1	Zone-1	
65	11-Aug-22	Phase- R-G	Phase- L1-N	A/R
		Distance- 35.7 Km	Distance-35.9Km	
		Current- 4.67 KA	Current- 4.630 KA	
		Zone-1	Zone-1	
66	1-Aug-22	Phase- R-G	Phase- L1-N	TRIP
		Distance- 38.00 Km	Distance-38.1 Km	
		Current- 4.26 KA	Current- 4.51 KA	
		Zone-2	Zone-2	
67	30-Jul-22	Phase- R-G	Phase- L1-N	TRIP
		Distance- 36.2 Km	Distance-36.4 Km	
		Current- 4.41 KA	Current- 4.64 KA	
		Zone-2	Zone-2	
68	24-Jul-22	Phase- Y-G	Phase- L2-N	A/R
		Distance- 24.9 Km	Distance-24.9 Km	
		Current- 6.03KA	Current- 6.042 KA	
		Zone-1	Zone-1	
69	21-Jul-22	Phase- Y-G	Phase- L2-N	TRIP
		Distance- 35.8 Km	Distance-36.1 Km	
		Current- 4.45 KA	Current- 4.74 KA	
		Zone-1	Zone-2	
70	21-Jul-22	Phase- B-G	Phase- L3-N	A/R
		Distance-23.2 Km	Distance-23.2 Km	
		Current- 6.22 KA	Current- 6.22 KA	
		Zone-1	Zone-1	
71	19-Jul-22	Phase- Y-G	Phase- L2-N	A/R
		Distance- 35.1Km	Distance-35.1Km	
		Current- 4.62 KA	Current- 4.69 KA	
		Zone-1	Zone-1	
72	18-Jul-22	Phase- Y-G	Phase- L2-N	A/R
		Distance- 1.5 Km	Distance-1.6 Km	
		Distance- 1.5 Km	Distance-1.6 Km	
		Zone-1	Zone-1	

<b>220 kV Baghpat-Shamli Line</b>				
<b>Tripping &amp; A/R Details</b>				
S.No.	Date	Fault Details		Category
		M1	M2	
73	16-Jul-22	Phase- R-G	Phase- L1-N	TRIP
		Distance- 39.1 Km	Distance-39.1Km	
		Current- 4.20 KA	Current- 4.5 KA	
		Zone-2	Zone-2	
74	13-Jul-22	Phase- Y-G	Phase- L2-N	A/R
		Distance- 18.9 Km	Distance-18.7Km	
		Current- 6.58 KA	Current- 7.13 KA	
		Zone-1	Zone-1	
75	11-Jul-22	Phase- R-G	Phase- L1-N	A/R
		Distance- 17.3 Km	Distance-17.00 Km	
		Current- 6.89 KA	Current- 7.612 KA	
		Zone-1	Zone-1	
76	5-Jun-22	Phase- Y-B	Phase- L2-L3	Trip
		Distance- 37.8 Km	Distance-37.7 Km	
		Current Iy- 5.05 KA current Ib-5.05 KA	Current L2-5.36 KA Current L3-4.74 KA	
		Zone-2	Zone-2	
77	4-Jun-22	Phase- R-G	Phase- L1-N	Trip
		Distance- 7.1 Km	Distance-7.0 Km	
		<b>Current- 11.15 KA</b>	<b>Current- 11.662 KA</b>	
		Zone-1	Zone-1	
78	3-Jun-22	Phase- B-G	Phase- L3-N	Trip
		Distance- 41.1 Km	Distance-41.6 Km	
		Current- 3.78 KA	Current- 4.225 KA	
		Zone-2	Zone-2	
79	2-Jun-22	Phase- B-G	Phase- L3-N	Trip
		Distance- 41.1 Km	Distance-41.8 Km	
		Current- 3.75 KA	Current- 4.14 KA	
		Zone-2	Zone-2	
80	31-May-22	Phase- B-G	Phase- L3-N	A/R
		Distance- 14.3 Km	Distance-16.2 Km	
		Current- 5.54 KA	Current- 6.26 KA	
		Zone-1	Zone-1	
81	30-Apr-22	Phase- R-G	Phase- L1-N	Trip
		Distance- 37.5 Km	Distance-38.95Km	
		Current- 3.41KA	Current- 2.88 KA	
		Zone-2	Zone-2	
82	13-Apr-22	Phase- Y-G	Phase- L2-N	Trip
		Distance- 37 Km	Distance-37.1 Km	
		Current- 4.28 KA	Current- 4.572 KA	
		Zone-2	Zone-2	
83	8-Apr-22	Phase- B-G	Phase- L3-N	A/R
		Distance- 11.38 Km	Distance-11.30 Km	
		Current- 8.5 KA	Current- 8.9 KA	
		Zone-1	Zone-1	
84	21-Mar-22	Phase- B-G	Phase- L3-N	Trip
		Distance- 42.2 Km	Distance-45.1 Km	
		Current- 3.36 KA	Current- 3.51 KA	
		Zone-2	Zone-2	

<b>220 kV Baghpat-Mandola Vihar Line</b>				
<b>Tripping &amp; A/R Details</b>				
<b>S.No.</b>	<b>Date</b>	<b>Fault Details</b>		<b>Category</b>
		<b>M1</b>	<b>M2</b>	
1	13-Nov-24	Phase- R-G	Phase- L1-N	A/R
		Distance- 19.1 Km	Distance- 18.9 Km	
		<b>Current- 6.32 KA</b>	<b>Current- 6.651KA</b>	
		Zone-1	Zone-1	
2	19-Sep-24	Phase- Y-G	Phase- L2-N	TRIP
		Distance- 9.5 Km	Distance- 9.4 Km	
		<b>Current- 10.34 KA</b>	<b>Current- 10.15 KA</b>	
		Zone-1	Zone-1	
3	19-Sep-24	Phase- Y-G	Phase- L2-N	TRIP
		Distance- 9.5 Km	Distance- 9.4 Km	
		<b>Current- 10.34 KA</b>	<b>Current- 10.15 KA</b>	
		Zone-1	Zone-1	
4	15-Sep-24	Phase- R-G	Phase- L1-N	TRIP
		Distance- 11.5 Km	Distance- 11.4 Km	
		<b>Current- 8.55 KA</b>	<b>Current- 8.791 KA</b>	
		Zone-1	Zone-1	
5	6-Aug-24	Phase- B-G	Phase- L3-N	TRIP
		Distance- 15.7 Km	Distance- 15.4 Km	
		<b>Current- 7.06 KA</b>	<b>Current- 7.08 KA</b>	
		Zone-1	Zone-1	
6	6-Jun-24	Phase- B-G	Phase- L3-N	TRIP
		Distance- 3.2 Km	Distance- 3.2 Km	
		<b>Current- 15.67 KA</b>	<b>Current- 15.186 KA</b>	
		Zone-1	Zone-1	
7	24-Apr-24	Phase- B-G	Phase- L3-N	A/R
		Distance- 8.0 Km	Distance- 7.9 Km	
		<b>Current- 10.84 KA</b>	<b>Current- 10.589 KA</b>	
		Zone-1	Zone-1	
8	22-Apr-24	Phase- B-G	Phase- L3-N	A/R
		Distance- 10.8 Km	Distance- 10.6 Km	
		<b>Current- 9.00 KA</b>	<b>Current- 9.094 KA</b>	
		Zone-1	Zone-1	
9	13-Apr-24	Phase- B-G	Phase- L3-N	A/R
		Distance- 10.8 Km	Distance- 10.6 Km	
		<b>Current- 8.91 KA</b>	<b>Current- 9.064 KA</b>	
		Zone-1	Zone-1	
10	26-Dec-23	Phase- R-G	Phase- L1-N	A/R
		Distance- 19.0 Km	Distance- 18.71 Km	
		<b>Current- 6.09 KA</b>	<b>Current- 6.159 KA</b>	
		Zone-1	Zone-1	
11	3-Dec-23	Phase- B-G	Phase- L3-N	A/R
		Distance- 9.6 Km	Distance- 9.6 Km	
		<b>Current- 9.66 KA</b>	<b>Current- 9.64 KA</b>	
		Zone-1	Zone-1	
12	21-Sep-23	Phase- Y-G	Phase- L2-N	A/R
		Distance- 7.8 Km	Distance- 7.6 Km	
		<b>Current- 10.23 KA</b>	<b>Current- 10.859 KA</b>	
		Zone-1	Zone-1	

<b>220 kV Baghpat-Mandola Vihar Line</b>				
<b>Tripping &amp; A/R Details</b>				
<b>S.No.</b>	<b>Date</b>	<b>Fault Details</b>		<b>Category</b>
		<b>M1</b>	<b>M2</b>	
13	30-Aug-23	Phase- B-G	Phase- L3-N	A/R
		Distance- 8.6 Km	Distance-8.4 Km	
		<b>Current- 9.26 KA</b>	<b>Current- 10.027 KA</b>	
		Zone-1	Zone-1	
14	5-Aug-23	Phase- B-G	Phase- L3-N	A/R
		Distance- 17.7 Km	Distance-17.2 Km	
		<b>Current- 6.04 KA</b>	<b>Current- 6.094 KA</b>	
		Zone-1	Zone-1	
15	27-Jul-23	Phase- Y-G	Phase- L2-N	A/R
		Distance- 3.2 Km	Distance-3.12 Km	
		<b>Current- 15.61 KA</b>	<b>Current- 15.41KA</b>	
		Zone-1	Zone-1	
16	24-Jul-23	Phase- Y-G	Phase- L2-N	A/R
		Distance- 17.5 Km	Distance-17.3 Km	
		<b>Current- 6.33 KA</b>	<b>Current- 6.22 KA</b>	
		Zone-1	Zone-1	
17	10-Jul-23	Phase- R-G	Phase- L1-N	A/R
		Distance- 10.5 Km	Distance-10.5 Km	
		<b>Current- 16.46 KA</b>	<b>Current- 10.53 KA</b>	
		Zone-1	Zone-1	
18	10-Jul-23	Phase- R-G	Phase- L1-N	A/R
		Distance- 10.5 Km	Distance-10.5 Km	
		<b>Current- 16.46 KA</b>	<b>Current- 10.53 KA</b>	
		Zone-1	Zone-1	
19	26-Jun-23	Phase- R-G	Phase- L1-N	A/R
		Distance- 23.1Km	Distance-22.9 Km	
		<b>Current- 6.48 KA</b>	<b>Current- 6.525 KA</b>	
		Zone-1	Zone-1	
20	9-Feb-23	Phase- R-G	Phase- L1-N	A/R
		Distance- 6.6 Km	Distance-6.6 Km	
		<b>Current- 12.34 KA</b>	<b>Current- 13.33 KA</b>	
		Zone-1	Zone-1	
21	19-Dec-22	Phase- R-G	Phase- L1-N	Trip
		Distance- 6.72 Km	Distance-22.6 Km	
		<b>Current- 22.9 KA</b>	<b>Current- 6.817 KA</b>	
		Zone-1	Zone-1	
22	19-Dec-22	Phase- R-G	Phase- L1-N	A/R
		Distance- 26.4 Km	Distance-26.1 Km	
		<b>Current- 5.78 KA</b>	<b>Current- 5.107 KA</b>	
		Zone-1	Zone-1	
23	19-Dec-22	Phase- R-G	Phase- L1-N	A/R
		Distance- 22.7 Km	Distance-22.9 Km	
		<b>Current- 6.46 KA</b>	<b>Current- 6.489 KA</b>	
		Zone-1	Zone-1	
24	8-Nov-22	Phase- R-G	Phase- L1-N	A/R
		Distance- 9.3 Km	Distance-9.3 Km	
		<b>Current- 10.78 KA</b>	<b>Current- 10.49 KA</b>	
		Zone-1	Zone-1	

<b>220 kV Baghpat-Mandola Vihar Line</b>				
<b>Tripping &amp; A/R Details</b>				
S.No.	Date	Fault Details		Category
		M1	M2	
25	8-Nov-22	Phase- R-G	Phase- L1-N	A/R
		Distance- 9.3 Km	Distance-9.3 Km	
		<b>Current- 10.78 KA</b>	<b>Current- 10.49 KA</b>	
		Zone-1	Zone-1	
26	30-Oct-22	Phase- B-G	Phase- L3-N	A/R
		Distance- 6.6 Km	Distance-6.6 Km	
		<b>Current- 12.91 KA</b>	<b>Current- 12.91 KA</b>	
		Zone-1	Zone-1	
27	30-Oct-22	Phase- B-G	Phase- L3-N	A/R
		Distance- 10.3 Km	Distance-10.2 Km	
		<b>Current- 10.57 KA</b>	<b>Current- 10.45 KA</b>	
		Zone-1	Zone-1	
28	29-Oct-22	Phase- Y-G	Phase- L2-N	A/R
		Distance- 11.5 Km	Distance-11.3 Km	
		<b>Current- 9.04 KA</b>	<b>Current- 9.916 KA</b>	
		Zone-1	Zone-1	
29	10-Oct-22	Phase- R-G	Phase- L1-N	A/R
		Distance- 4.3 Km	Distance-4.3 Km	
		<b>Current- 14.08 KA</b>	<b>Current- 15.05 KA</b>	
		Zone-1	Zone-1	
30	5-Aug-22	Phase- Y-G	Phase- L2-N	A/R
		Distance- 5.2 Km	Distance-5.2 Km	
		<b>Current- 13.13 KA</b>	<b>Current- 14.12 KA</b>	
		Zone-1	Zone-1	
31	31-Jul-22	Phase- B-G	Phase- L3-N	A/R
		Distance-13.5 KM	Distance- 13.9KM	
		<b>current-7.73KA</b>	<b>current- 8.657KA</b>	
		zone-1	zone-1	
32	21-Jul-22	Phase- Y-G	Phase- L2-N	A/R
		Distance- 22.1KM	Distance- 22.7KM	
		<b>current- 6.20KA</b>	<b>current- 6.288KA</b>	
		zone-1	zone-1	
33	21-Jul-22	Phase- Y-G	Phase- L2-N	A/R
		Distance- 21.7KM	Distance- 21.6KM	
		<b>current- 6.50KA</b>	<b>current- 6.52KA</b>	
		zone-1	zone-1	
34	10-Jul-22	Phase- B-G	Phase- L3-N	A/R
		Distance- 11.7KM	Distance- 11.6KM	
		<b>current- 9.64KA</b>	<b>current- 9.501KA</b>	
		zone-1	zone-1	
35	1-Jul-22	Phase- Y-G	Phase- L2-N	A/R
		Distance- 14.9KM	Distance- 14.8KM	
		<b>current- 8.13KA</b>	<b>current- 8.083KA</b>	
		zone-1	zone-1	
36	11-Jun-22	Phase- B-G	Phase- L3-N	A/R
		Distance- 16.9KM	Distance- 16.7KM	
		<b>current- 7.0KA</b>	<b>current- 7.4KA</b>	
		zone-1	zone-1	

<b>220 kV Baghpat-Mandola Vihar Line</b>				
<b>Tripping &amp; A/R Details</b>				
<b>S.No.</b>	<b>Date</b>	<b>Fault Details</b>		<b>Category</b>
		<b>M1</b>	<b>M2</b>	
<b>37</b>	<b>29-May-22</b>	Phase- R-G	Phase- L1-N	<b>TRIP</b>
		Distance- 23.0KM	Distance- 23.1KM	
		<b>current- 6.18KA</b>	<b>current- 6.15KA</b>	
		zone-1	zone-1	
<b>38</b>	<b>30-Mar-22</b>	Phase- Y-G	Phase- L2-N	<b>A/R</b>
		Distance- 12.4KM	Distance- 12.2KM	
		<b>current- 8.65KA</b>	<b>current- 9.53KA</b>	
		zone-1	zone-1	

<b>220 kV Baghpat-Baghpat ckt-1</b>				
<b>Tripping &amp; A/R Details</b>				
<b>S.No.</b>	<b>Date</b>	<b>Fault Details</b>		<b>Category</b>
		<b>M1</b>	<b>M2</b>	
<b>1</b>	<b>6-Sep-24</b>	Phase- Y-G	Phase- L2-N	<b>TRIP</b>
		Distance- 14.2KM	Distance-14.4KM	
		<b>Current-10.8KA</b>	<b>Current- 7.35KA</b>	
		Zone-1	Zone-1	
<b>2</b>	<b>1-Jul-24</b>	Phase- B-G	Phase- L3-N	<b>TRIP</b>
		Distance- 11.5KM	Distance-11.5KM	
		<b>Current-9.67KA</b>	<b>Current- 9.686KA</b>	
		Zone-1	Zone-1	
<b>3</b>	<b>21-Jan-24</b>	Phase- Y-G	Phase- L2-N	<b>TRIP</b>
		Distance- 7.2KM	Distance-7.3KM	
		<b>Current-10.85KA</b>	<b>Current- 10.678KA</b>	
		Zone-1	Zone-1	
<b>4</b>	<b>31-Dec-23</b>	Phase- B-N	Phase- L3-N	<b>TRIP</b>
		Distance- 1.9 KM	Distance-1.9KM	
		<b>Current-18.43 KA</b>	<b>Current- 17.905KA</b>	
		Zone-1	Zone-1	
<b>5</b>	<b>19-Dec-22</b>	Phase- B-G	Phase- L3-N	<b>TRIP</b>
		Distance- 12.7KM	Distance-15.1KM	
		<b>Current-9.89 KA</b>	<b>Current- 6.428 KA</b>	
		Zone-2	Zone-2	
<b>6</b>	<b>9-Nov-22</b>	Phase- R-G	Phase- L1-N	<b>A/R</b>
		Distance- 1.4KM	Distance-1.4KM	
		<b>Current-20.36 KA</b>	<b>Current- 22.152 KA</b>	
		Zone-1	Zone-1	
<b>7</b>	<b>8-Oct-22</b>	Phase- Y-G	Phase- L2-N	<b>A/R</b>
		Distance- 5.7KM	Distance-5.7KM	
		<b>Current-12.53 KA</b>	<b>Current- 13.39 KA</b>	
		Zone-1	Zone-1	
<b>8</b>	<b>22-May-22</b>	Phase- Y-G	Phase- L2-N	<b>A/R</b>
		Distance- 10.2KM	Distance-10.8KM	
		<b>Current-7.28 KA</b>	<b>Current- 7.203 KA</b>	
		Zone-1	Zone-1	

220 kV Baghpat-Baghpat ckt-2				
Tripping & A/R Details				
S.No.	Date	Fault Details		Category
		M1	M2	
1	28-Aug-24	Phase- Y-G	Phase- L2-N	TRIP
		Distance- 10.6KM	Distance- 11.7KM	
		Current- 8.58KA	Current- 6.678KA	
		Zone-1	Zone-1	
2	1-Jul-24	Phase- Y-G	Phase- L2-N	TRIP
		Distance- 8.4KM	Distance- 8.6KM	
		Current- 8.97KA	Current- 8.961KA	
		Zone-1	Zone-1	
3	10-May-24	Phase- B-G	Phase- L3-N	TRIP
		Distance- 5.9 Km	Distance- 5.93 Km	
		Current- 10.96 KA	Current- 11.313 KA	
		Zone-1	Zone-1	
4	31-Dec-23	Phase- B-G	DATA NOT AVAILABLE	TRIP
		Distance- 15.10 Km		
		Current- 7.267 KA		
		Zone-1		
5	26-Dec-23	Phase- B-G	Phase- L3-N	TRIP
		Distance- 2.4 Km	Distance- 2.3 Km	
		Current- 15.38 KA	Current- 15.21 KA	
		Zone-1	Zone-1	
6	7-Dec-23	Phase- R-G	Phase- L1-N	TRIP
		Distance- 6.9 Km	Distance- 6.9 Km	
		Current- 11.76 KA	Current- 11.52 KA	
		Zone-1	Zone-1	
7	23-Sep-23	Phase- R-G	Phase- L1-N	TRIP
		Distance- 2.3Km	Distance- 2.2Km	
		Current- 17.88 KA	Current- 16.9 KA	
		Zone-1	Zone-1	
8	14-May-23	Phase- R-G	Phase- L1-N	TRIP
		Distance- 97.8Km (137.7%)	Distance- NA	
		Current- 2.18KA	Current- 2.228KA	
		Zone-2	Zone-1	
9	13-Mar-23	Phase- R-G	Phase- L1-N	TRIP
		Distance- 8.1Km	Distance- 6.2Km	
		Current- 11.90KA	Current- 11.662KA	
		Zone-1	Zone-1	
10	20-Dec-22	Phase- B-G	Phase- L3-N	TRIP
		Distance- 20.9Km	Distance- 15.1Km	
		Current- 6.32KA	Current- 6.346KA	
		Zone-1	Zone-2	
11	20-Dec-22	Phase- B-G	Phase- L3-N	A/R
		Distance- 17.01Km	Distance- 12.9Km	
		Current- 7.19KA	Current- 7.35KA	
		Zone-1	Zone-1	
12	20-Dec-22	Phase- Y-G	Phase- L2-N	TRIP
		Distance- 12.6Km	Distance- 9.6Km	
		Current- 9.08KA	Current- 9.29KA	
		Zone-1	Zone-1	



220 kV Baghpat-Baghpat ckt-2				
Tripping & A/R Details				
S.No.	Date	Fault Details		Category
		M1	M2	
13	19-Dec-22	Phase- B-G	Phase- L3-N	A/R
		Distance- 10.7Km	Distance- 8.1Km	
		Current- 10.80KA	Current- 11.13KA	
		Zone-1	Zone-1	
14	19-Dec-22	Phase- B-G	Phase- L3-N	A/R
		Distance- 2.2 Km	Distance- 1.6Km	
		Current- 17.02 KA	Current- 16.99 KA	
		Zone-1	Zone-1	
15	19-Dec-22	Phase- B-G	Phase- L3-N	A/R
		Distance- 12.4 Km	Distance- NA	
		Current- 10.72 KA	Current- NA	
		Zone-1	Zone-NA	
16	19-Dec-22	Phase- Y-G	Phase- L2-N	A/R
		Distance- 6.3 Km	Distance- 4.9Km	
		Current- 14.59 KA	Current- 14.65 KA	
		Zone-1	Zone-1	
17	19-Dec-22	Phase- B-G	Phase- L3-N	A/R
		Distance- 22.6 Km	Distance- 15.1Km	
		Current- 5.83 KA	Current- 5.91 KA	
		Zone-1	Zone-2	
18	19-Dec-22	Phase- B-G	Phase- L3-N	A/R
		Distance- 6.6 Km	Distance- 5.0 Km	
		Current- 14.14 KA	Current- 14.19 KA	
		Zone-1	Zone-1	
19	21-Nov-22	Phase- Y-G	Phase- L2-N	A/R
		Distance- 15.1 Km	Distance- 11.7 Km	
		Current- 8.81 KA	Current- 8.416 KA	
		Zone-1	Zone-1	
20	9-Nov-22	Phase- R-G	Phase- L1-N	A/R
		Distance- 75.7 Km	Distance- 3.1 Km	
		Current- 7.36 KA	Current- 17.475 KA	
		Zone-1	Zone-1	
21	17-Oct-22	Phase- R-G	Phase- L1-N	A/R
		Distance- 4.1 Km	Distance- 3.1 Km	
		Current- 17.47 KA	Current- 17.475 KA	
		Zone-1	Zone-1	
22	8-Oct-22	Phase- Y-G	Phase- L2-N	A/R
		Distance- 34.8 Km	Distance-15.1 Km	
		Current- 3.28 KA	Current- 3.32 KA	
		Zone-1	Zone-2	
23	30-May-22	Phase- R-G	Phase- L1-N	TRIP
		Distance- 17.8 Km	Distance-13.4 Km	
		Current- 6.84 KA	Current- 7.08 KA	
		Zone-1	Zone-1	

<b>220 kV Baghpat-Modipuram ckt-1</b>				
<b>Tripping &amp; A/R Details</b>				
<b>S.No.</b>	<b>Date</b>	<b>Fault Details</b>		<b>Category</b>
		<b>M1</b>	<b>M2</b>	
<b>1</b>	<b>30-Oct-24</b>	Phase- B-G	Phase- L3-N	<b>TRIP</b>
		<b>Current- 9.69 KA</b>	<b>Current- 9.742 KA</b>	
		Distance- 10.9 Km	Distance- 11.7KM	
		Zone-1	Zone-1	
<b>2</b>	<b>29-Oct-24</b>	Phase- Y-G	Phase- L2-N	<b>TRIP</b>
		<b>Current- 7.3 KA</b>	<b>Current- 7.386 KA</b>	
		Distance- 16.2 Km	Distance- 17.9KM	
		Zone-1	Zone-1	
<b>3</b>	<b>19-Sep-24</b>	Phase- B-G	Phase- L3-N	<b>TRIP</b>
		<b>Current- 6.86 KA</b>	<b>Current- 6.462 KA</b>	
		Distance- 17.9 Km	Distance- 20.9KM	
		Zone-1	Zone-1	
<b>4</b>	<b>4-Aug-24</b>	Phase- B-G	Phase- L3-N	<b>TRIP</b>
		<b>Current- 13.6 KA</b>	<b>Current- 4.994 KA</b>	
		Distance- .2 Km	Distance- 38.3 KM	
		Zone-1	Zone-1	
<b>5</b>	<b>23-Jun-24</b>	Phase- B-G	Phase- L3-N	<b>TRIP</b>
		<b>Current- 4.34 KA</b>	<b>Current- 4.994 KA</b>	
		Distance- 29.2 Km	Distance- 38.3 KM	
		Zone-1	Zone-1	
<b>6</b>	<b>28-Apr-24</b>	Phase- Y-G	Phase- L2-N	<b>TRIP</b>
		<b>Current- 6.33KA</b>	<b>Current- 6.384KA</b>	
		Distance- 25.6 Km	Distance- 21.6 KM	
		Zone-1	Zone-1	
<b>7</b>	<b>23-Apr-24</b>	Phase- B-G	Phase- L3-N	<b>TRIP</b>
		<b>Current- 6.05 KA</b>	<b>Current- 6.063KA</b>	
		Distance- 25.8 Km	Distance- 25.4 KM	
		Zone-1	Zone-1	
<b>8</b>	<b>13-Dec-23</b>	Phase- B-G	Phase- L3-N	<b>A/R</b>
		<b>Current- 8.78 KA</b>	<b>Current- 8.911 KA</b>	
		Distance-11.9 Km	Distance- 14.9 KM	
		Zone-1	Zone-1	
<b>9</b>	<b>6-Dec-23</b>	Phase- B-G	Phase- L3-N	<b>A/R</b>
		<b>Current- 5.52 KA</b>	<b>Current- 5.57 KA</b>	
		Distance-20.8 KM	Distance- 38.3 KM	
		Zone-1	Zone-1	
<b>10</b>	<b>4-Dec-23</b>	Phase- B-G	Phase- L3-N	<b>A/R</b>
		<b>Current- 9.22 KA</b>	<b>Current- 9.558 KA</b>	
		Distance-10.8 KM	Distance- 13.1 KM	
		Zone-1	Zone-1	
<b>11</b>	<b>6-Nov-23</b>	Phase- R-G	Phase- L2-N	<b>A/R</b>
		<b>Current- 12.42 KA</b>	<b>Current- 12.175 KA</b>	
		Distance- 7.2 KM	Distance- 8.0 KM	
		Zone-1	Zone-1	
<b>12</b>	<b>9-Oct-23</b>	Phase- Y-G	Phase- L2-N	<b>A/R</b>
		<b>Current- 2.685 KA</b>	<b>Current- 2.759 KA</b>	
		Distance- 16.94 KM	Distance- 16.67 KM	
		Zone-1	Zone-1	

<b>220 kV Baghpat-Modipuram ckt-1</b>				
<b>Tripping &amp; A/R Details</b>				
S.No.	Date	Fault Details		Category
		M1	M2	
13	8-Oct-23	Phase- Y-G	Phase- L2-N	A/R
		<b>Current- 6.60 KA</b>	<b>Current- 6.959 KA</b>	
		Distance- 16.8 KM	Distance- 24.2 KM	
		Zone-1	Zone-1	
14	8-Oct-23	Phase- Y-G	Phase- L2-N	A/R
		<b>Current- 6.33 KA</b>	<b>Current- 6.99KA</b>	
		Distance- 16.6 KM	Distance- 24.1 KM	
		Zone-1	Zone-1	
15	26-Sep-23	Phase- B-G	Phase- L3-N	A/R
		<b>Current- 6.16 KA</b>	<b>Current- 6.624 KA</b>	
		Distance- 17.7KM	Distance- 27.3KM	
		Zone-1	Zone-1	
16	25-Sep-23	Phase- B-G	Phase- L3-N	A/R
		<b>Current- 5.96 KA</b>	<b>Current- 6.564 KA</b>	
		Distance- 17.9KM	Distance- 27.3KM	
		Zone-1	Zone-1	
17	25-Sep-23	Phase- B-G	Phase- L3-N	A/R
		<b>Current- 9.19 KA</b>	<b>Current- 9.056 KA</b>	
		Distance- 10.9KM	Distance- 13.2KM	
		Zone-1	Zone-1	
18	23-Aug-23	Phase- B-G	Phase- L3-N	A/R
		<b>Current- 6.48KA</b>	<b>Current- 6.389KA</b>	
		Distance- 17.7KM	Distance- 28.7KM	
		Zone-1	Zone-1	
19	19-Aug-23	Phase- B-G	Phase- L3-N	A/R
		<b>Current- 6.61KA</b>	<b>Current- 6.656KA</b>	
		Distance- 18.1KM	Distance- 29.1KM	
		Zone-1	Zone-1	
20	3-Aug-23	Phase- B-G	Phase- L3-N	A/R
		<b>Current- 8.00KA</b>	<b>Current- 8.76KA</b>	
		Distance- 12.4KM	Distance- 15.4KM	
		Zone-1 (32.3%)	Zone-1 (40.2%)	
21	31-Jul-23	Phase- B-G	Phase- L3-N	A/R
		<b>Current- 8.67KA</b>	<b>Current- 8.516KA</b>	
		Distance- 11.7KM	Distance- 14.7KM	
		Zone-1	Zone-1	
22	11-Jul-23	Phase- B-G	Phase- L3-N	TRIP
		<b>Current- 4.76KA</b>	<b>Current- 3.576KA</b>	
		Distance-34.6KM	Distance- 38.3KM	
		Zone-2	Zone-2	
23	30-Jun-23	Phase- B-G	Phase- L3-N	A/R
		<b>Current- 7.98KA</b>	<b>Current- 8.479KA</b>	
		Distance-12.6KM	Distance- 16.0KM	
		Zone-1	Zone-1	
24	29-May-23	Phase- B-G	Phase- L3-N	TRIP
		<b>Current- 6.20KA</b>	<b>Current- 6.3KA</b>	
		Distance-17.8KM	Distance- 32.7KM	
		Zone-1	Zone-1	

<b>220 kV Baghpat-Modipuram ckt-1</b>				
<b>Tripping &amp; A/R Details</b>				
<b>S.No.</b>	<b>Date</b>	<b>Fault Details</b>		<b>Category</b>
		<b>M1</b>	<b>M2</b>	
<b>25</b>	<b>30-Mar-23</b>	Phase- NA	Phase- L1-N & L2-N	<b>TRIP</b>
		<b>Current-NA</b>	<b>Current- 3.347KA</b>	
		Distance-NA	Distance- 38.3KM	
		Zone-NA	Zone-1	
<b>26</b>	<b>29-Mar-23</b>	Phase- R-Y	Phase- L1-L2	<b>TRIP</b>
		<b>Current-7.27KA</b>	<b>Current- 3.28KA</b>	
		Distance-149.9KM	Distance- 38.3KM	
		Zone-1	Zone-1	
<b>27</b>	<b>10-Mar-23</b>	Phase- R-G	Phase- L1-N	<b>TRIP</b>
		<b>Current- 9.83KA</b>	<b>Current- 9.791KA</b>	
		Distance-10.5KM	Distance- 13.50KM	
		Zone-1	Zone-1	
<b>28</b>	<b>22-Oct-22</b>	Phase- Y-G	Phase- L2-N	<b>TRIP</b>
		<b>Current- 7.83KA</b>	<b>Current- 8.31KA</b>	
		Distance-13.5KM	Distance- 20.5KM	
		Zone-1	Zone-1	
<b>29</b>	<b>2-Oct-22</b>	Phase- R-G	Phase- L1-N	<b>TRIP/ SHUTDOWN</b>
		<b>Current- 6.89KA</b>	<b>Current- 9.0KA</b>	
		Distance-8.7KM	Distance- 11.8KM	
		Zone-1	Zone-1	
<b>30</b>	<b>1-Oct-22</b>	Phase- R-G	Phase- L1-N	<b>A/R+TRIP</b>
		<b>Current- 7.72KA+7.04KM</b>	<b>Current- 2.5KA</b>	
		Distance-9.1KM+9.0KM	Distance-	
		Zone-1	Zone-1	
<b>31</b>	<b>30-Sep-22</b>	Phase- Y-G	Phase- L2-N	<b>A/R</b>
		<b>Current- 5.36KA</b>	<b>Current- 5.41KA</b>	
		Distance-20.5	Distance- 38.3KM	
		Zone-1	Zone-1	

<b>220 kV Baghpat-Modipuram ckt-2</b>				
<b>Tripping &amp; A/R Details</b>				
S.No.	Date	Fault Details		Category
		M1	M2	
1	10-Oct-24	Phase- Y-G	Phase- L2-N	TRIP
		<b>Current- 4.45 KA</b>	<b>Current- 4.538KA</b>	
		Distance- 27.4 KM	Distance- 38.3 KM	
		Zone-1	Zone-1	
2	7-Sep-24	Phase- B-G	Phase- L3-N	TRIP
		<b>Current- 12.28 KA</b>	<b>Current- 12.556KA</b>	
		Distance- 7 KM	Distance- 7 KM	
		Zone-1	Zone-1	
3	5-May-24	Phase- R-G	Phase- L1-N	TRIP
		<b>Current- 9.18 KA</b>	<b>Current- 9.817 KA</b>	
		Distance- 11.2 KM	Distance- 11.5 KM	
		Zone-1	Zone-1	
4	21-Feb-24	Phase- R-G	Phase- L1-N	TRIP
		<b>Current- 9.53 KA</b>	<b>Current- 9.412KA</b>	
		Distance- 11.1 KM	Distance- 13.5KM	
		Zone-1	Zone-1	
5	8-Feb-24	Phase- B-G	Phase- L3-N	TRIP
		<b>Current- 15.34 KA</b>	<b>Current- 14.95 KA</b>	
		Distance- 4.1 KM	Distance- 4.27 KM	
		Zone-1	Zone-1	
6	1-Oct-23	Phase- Y-G	Phase- L2-N	A/R
		<b>Current- 4.73 KA</b>	<b>Current- 4.7 KA</b>	
		Distance- 26.1 KM	Distance-38.3 KM	
		Zone-1	Zone-1	
7	23-Sep-23	Phase- R-G	Phase- L1-N	A/R
		<b>Current- 9.80 KA</b>	<b>Current- 9.88 KA</b>	
		Distance- 10.4 KM	Distance- 5.1 KM	
		Zone-1	Zone-1	
8	7-Sep-23	Phase- R-G	Phase- L1-N	A/R
		<b>Current- 8.06KA</b>	<b>Current- 8.915KA</b>	
		Distance- 12.0KM	Distance- 14.5KM	
		Zone-1	Zone-1	
9	6-Sep-23	Phase- Y-G	Phase- L2-N	A/R
		<b>Current- 4.45KA</b>	<b>Current- 4.48KA</b>	
		Distance- 8.519KM	Distance- 8.397KM	
		Zone-1	Zone-1	
10	15-Aug-23	Phase- R-G	Phase- L1-N	A/R
		<b>Current- 5.54KA</b>	<b>Current- 5.596KA</b>	
		Distance- 21.2KM	Distance- 37.0KM	
		Zone-1 (55.4%)	Zone-2 (96.7%)	
11	12-Aug-23	Phase- R-G	Phase- L1-N	TRIP
		<b>Current- 6.12KA</b>	<b>Current- 6.082KA</b>	
		Distance- 27.6KM	Distance- 21.6KM	
		Zone-1	Zone-1	
12	29-Jul-23	Phase- B-G	Phase- L3-N	A/R
		<b>Current- 6.08KA</b>	<b>Current- 6.358KA</b>	
		Distance- 18.80KM	Distance- 31.5KM	
		Zone-1 (49.1%)	Zone-2 (82.2%)	

<b>220 kV Baghpat-Modipuram ckt-2</b>				
<b>Tripping &amp; A/R Details</b>				
<b>S.No.</b>	<b>Date</b>	<b>Fault Details</b>		<b>Category</b>
		<b>M1</b>	<b>M2</b>	
<b>13</b>	<b>10-Jul-23</b>	Phase- R-G	Phase- L1-N	<b>A/R</b>
		<b>Current- 3.78KA</b>	<b>Current- 3.764KA</b>	
		Distance- 29.3KM	Distance- 38.3KM	
		Zone-1	Zone-	
<b>14</b>	<b>19-Jun-23</b>	Phase- B-G	Phase- L3-N	<b>A/R</b>
		<b>Current- 7.29KA</b>	<b>Current- 7.44KA</b>	
		Distance- 12.9KM	Distance- 16.4KM	
		Zone-1	Zone-1	
<b>15</b>	<b>31-May-23</b>	Phase- Y-G	Phase- L2-N	<b>A/R</b>
		<b>Current- 6.36KA</b>	<b>Current- 6.33KA</b>	
		Distance- 34.94KM	Distance- 17.9KM	
		Zone-1	Zone-1	
<b>16</b>	<b>4-Dec-22</b>	Phase- R-G	Phase- L1-N	<b>TRIP</b>
		<b>Current- 4.62KA</b>	<b>Current- 4.65KA</b>	
		Distance- 25.1KM	Distance- 38.3KM	
		Zone-1	Zone-2	
<b>17</b>	<b>11-Oct-22</b>	Phase- Y-G	Phase- L2-N	<b>A/R</b>
		<b>Current- 8.05KA</b>	<b>Current- 8.572KA</b>	
		Distance-13.7KM	Distance- 20.41KM	
		Zone-1	Zone-1	
<b>18</b>	<b>20-Sep-22</b>	Phase- B-G	Phase- L3-N	<b>TRIP</b>
		<b>Current- 4.53KA</b>	<b>Current- 4.57KA</b>	
		Distance-24.7KM	Distance- 38.3KM	
		Zone-1	Zone-2	

 Outlook

---

**Frequent tripping of 220 kV Transmission Lines of UPPTCL connected to POWERGRID, GIS Baghpat.**

---

From Abhishek Shasta (अभिषेक शास्ता) <abhishek.shasta@powergrid.in>

Date Thu 11/21/2024 6:48 PM

To cetw@upptcl.org <cetw@upptcl.org>

Cc eeetdmrt@gmail.com <eeetdmrt@gmail.com>; EE ETD Baraut <eeetdbaraut@upptcl.org>; eeetdshamli@upptcl.org <eeetdshamli@upptcl.org>; eeetd1gzb@upptcl.org <eeetd1gzb@upptcl.org>; SE ETC Meerut <setmrt@upptcl.org>; seetcmzn@upptcl.org <seetcmzn@upptcl.org>; setgzb@upptcl.org <setgzb@upptcl.org>; rtamc.nr1 <rtamc.nr1@powergrid.in>; Vishal Roy (विशाल रॉय) <vishal.roy@powergrid.in>; Kuleshwar Sahu (कुलेश्वर साहू) <kuleshwar@powergrid.in>; Neeraj Kumar (नीरज कुमार) <Neerajk@powergrid.in>; Pankaj Kumar Jha (पंकज कुमार झा) <pankajjha@powergrid.in>; Aman Ankur (अमन अंकुर) <Aman.ankur@powergrid.in>; gisbaghpat <gisbaghpat@powergrid.in>

 1 attachment (5 MB)

letter to UPPTCL dated 201124 alongwith Tripping Report.pdf;

Dear Sir,

This has reference to our earlier letters/emails written to UPPTCL on the subject matter. In this regard, it is to inform that in recent past the 220 kV Transmission Lines of UPPTCL connected to POWERGRID, GIS Baghpat are tripping/auto-reclosing very frequently due to severe transient and permanent faults. **The transmission lines are proving to be dangerously hazardous as is evident from the data tabulated below:**

S.N.	Name of the Element	No. of Faults			
		CY'22	CY'23	CY'24	Total
1	220kV Baghpat (PG)-Shamli (UP) Line	37	23	24	84
2	220kV Baghpat (PG)-Mandola Vihar (UP) Line	18	11	9	38
3	220kV Baghpat (PG)-Baghpat(UP) Ckt-I	4	1	3	8
4	220kV Baghpat (PG)-Baghpat(UP) Ckt-II	14	6	3	23
5	220kV Baghpat (PG)-Modipuram(UP) Ckt-I	4	20	7	31
6	220kV Baghpat (PG)-Modipuram(UP) Ckt-II	3	10	5	18

You will appreciate that such occurrences result in problems for not just UPPTCL but POWERGRID and Outage Management Units as well.

You are already aware that such frequent unwarranted trippings of transmission lines results in flow of heavy fault current through connected 400/220 kV ICTs and other bay equipment at GIS Baghpat of POWERGRID, thus adversely affecting equipment life. **It is worth highlighting that these frequent faults causing tripping/auto-reclosure have already resulted in failure of circuit breaker of the bay connected**

**to 220 kV Baghpat (PG)-Shamli (UP) transmission line in August 2023, thus resulting in heavy financial loss to POWERGRID and long system outage.** POWERGRID substation at Baghpat is based on advance GIS technology loaded with expensive equipment and POWERGRID cannot afford such frequent feeding of severe fault current through its ICT & other equipment.

Considering the above-mentioned circumstances and already occurrence of a failure, **you are requested to kindly look into the matter on priority and arrange to take up necessary remedial action** including thorough patrolling of aforesaid lines **to ensure the rectification of defects and maintain healthiness of transmission system** elements installed at POWERGRID Baghpat GIS Station, so that uninterrupted power supply may be extended to UPPTCL substations.

Inspite of our earlier requests to address this issue of frequent tripping/autoreclosures, situation has not improved much in UPPTCL lines. It may please be noted that **POWERGRID shall be forced to review its A/R settings in case such frequent fault feeding is not arrested urgently from UPPTCL lines.** We trust that your team will prioritize this matter this time and take appropriate measures to address the ongoing challenges.

Looking forward for a prompt & positive action and continued support from your end.

Regards,  
Abhishek Shasta  
Sr.DGM (Baghpat GIS)  
Power Grid Corporation of India Limited



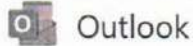

---

**Re: Frequent tripping of 220 kV Transmission Lines of UPPTCL connected to POWERGRID GIS Baghpat**

---

From gisbaghpat <gisbaghpat@powergrid.in>

Date Wed 6/26/2024 4:46 PM

To cetw@upptcl.org <cetw@upptcl.org>

Cc SE ETC Meerut <setmrt@upptcl.org>; eeetdmrt@gmail.com <eeetdmrt@gmail.com>; EE ETD Baraut <eeetdbaraut@upptcl.org>; eeetdshamli@upptcl.org <eeetdshamli@upptcl.org>; eeetd1gzb@upptcl.org <eeetd1gzb@upptcl.org>; Ravindra Nath Gupta {आर.एन. गुप्ता} <ravindrangupta@powergrid.in>; Ashok Kumar {ए. कुमार} <a.kumar@powergrid.in>; Rajeev Kumar {राजीव कुमार} <Rajivkumar@powergrid.in>; Abhishek Shasta {अभिषेक शास्ता} <abhishek.shasta@powergrid.in>; Mayank Rana {मयंक राणा} <ranamayank11@powergrid.in>

2 attachments (13 MB)

Letter to UPPTCL informing about multiple trippings in 220kV lines.PDF; Tripping Details.PDF;

Dear Sir,

This has reference to our earlier letters/Emails written to UPPTCL on the subject matter. In this regard, it is to inform that in these 220 kV Transmission Lines of UPPTCL connected to POWERGRID, GIS Baghpat are tripping/auto-reclosing very frequently again due to severe transient and permanent faults. **220 kV Baghpat(PG)-Shamli (UP) line tripped 08 times in the month of May'24.**

You are already aware that such frequent unwarranted trippings of transmission lines results in flow of heavy fault current through connected 400/220 kV ICTs and other bay equipment at GIS Baghpat of POWERGRID, thus adversely affecting equipment life.

You are again requested to kindly look into the matter on priority and arrange to take up necessary action including thorough patrolling of aforesaid lines to ensure the rectification of defects and maintain healthiness of transmission system

The detail of trippings is attached herewith for your kind reference please.

Looking forward for a prompt & positive action and continued support from your end.

Regards,  
Abhishek Shasta  
Sr. DGM-Baghpat SS, POWERGRID

---

**From:** Abhishek Shasta {अभिषेक शास्ता} <abhishek.shasta@powergrid.in>

**Sent:** 06 February 2024 13:37

**To:** cetw@upptcl.org <cetw@upptcl.org>

**Cc:** SE ETC Meerut <setmrt@upptcl.org>; eeetdmrt@gmail.com <eeetdmrt@gmail.com>; EE ETD Baraut <eeetdbaraut@upptcl.org>; eeetdshamli@upptcl.org <eeetdshamli@upptcl.org>; eeetd1gzb@upptcl.org



<eeetd1gzb@upptcl.org>; Ravindra Nath Gupta {आर.एन. गुप्ता} <ravindrangupta@powergrid.in>; Ashok Kumar {ए. कुमार} <a.kumar@powergrid.in>; Mayank Rana {मयंक राणा} <ranamayank11@powergrid.in>; gisbaghpat <gisbaghpat@powergrid.in>

**Subject:** Fw: Frequent tripping of 220 kV Transmission Lines of UPPTCL connected to POWERGRID GIS Baghpat

Dear Sir,

As desired in yesterday's meeting, email dated 21.12.2023 containing attached letter of even date is being forwarded once again for your information & reference please, with a request for continued support from your end for improvement in transmission system.

Regards,

Abhishek Shasta

Sr.DGM (Baghpat GIS)

Power Grid Corporation of India Limited

**From:** Abhishek Shasta {अभिषेक शास्ता} <abhishek.shasta@powergrid.in>

**Sent:** Thursday, December 21, 2023 5:30 PM

**To:** cetw@upptcl.org <cetw@upptcl.org>

**Cc:** eeetdmrt@gmail.com <eeetdmrt@gmail.com>; eeetdbaraut@upptcl.org <eeetdbaraut@upptcl.org>; eeetdshamli@upptcl.org <eeetdshamli@upptcl.org>; eeetd1gzb@upptcl.org <eeetd1gzb@upptcl.org>; Ashok Kumar Behera {ए.के. बेहरा} <akbehera@powergrid.in>; Ravindra Nath Gupta {आर.एन. गुप्ता} <ravindrangupta@powergrid.in>; Surendra Kumar Jaiswal {एस.के. जयसवाल} <skjaiswal@powergrid.in>; Vishal Roy {विशाल रॉय} <vishal.roy@powergrid.in>; rtamc.nr1 <rtamc.nr1@powergrid.in>; Surya Chandra Rao Teki {टी.एस.सी.राव} <surya@powergrid.in>; Neeraj Kumar {नीरज कुमार} <Neerajk@powergrid.in>; Sandeep Yadav {संदीप यादव} <sandeepyadav@powergrid.in>; Mayank Rana {मयंक राणा} <ranamayank11@powergrid.in>; gisbaghpat <gisbaghpat@powergrid.in>

**Subject:** Frequent tripping of 220 kV Transmission Lines of UPPTCL connected to POWERGRID GIS Baghpat

Dear Sir,

This has reference to our earlier letters written to UPPTCL on the subject matter. In this regard, it is to inform that in recent past the 220 kV Transmission Lines of UPPTCL connected to POWERGRID, GIS Baghpat are tripping/auto-reclosing very frequently due to severe transient and permanent faults. **The transmission lines are proving to be dangerously hazardous as is evident from the data tabulated below:**

S.N.	Name of the Element	No. of Faults in CY'23 & CY'22
1	220 kV Baghpat (PG)-Shamli (UP) Line	59
2	220 kV Baghpat (PG)-Mandola Vihar (UP)	28
3	220 kV Baghpat (PG)-Baghpat(UP) Ckt-I	04
4	220 kV Baghpat (PG)-Baghpat(UP) Ckt-II	18
5	220 kV Baghpat (PG)-Modipuram(UP) Ckt-I	24
6	220 kV Baghpat (PG)-Modipuram(UP) Ckt-II	13

You will appreciate that such occurrences result in problems for not just UPPTCL but POWERGRID and Outage Management Units as well.

You are already aware that such frequent unwarranted trippings of transmission lines results in flow of heavy fault current through connected 400/220 kV ICTs and other bay equipment at GIS Baghpat of POWERGRID, thus adversely affecting equipment life. **It is worth highlighting that these frequent faults causing tripping/auto-reclosure have already resulted in failure of circuit breaker of the bay connected to 220 kV Baghpat (PG)-Shamli (UP) transmission line recently in August 2023, thus resulting in heavy financial loss to POWERGRID and long system outage.** POWERGRID substation at Baghpat is based on advance GIS technology loaded with expensive equipment and POWERGRID cannot afford such frequent feeding of severe fault current through its ICT & other equipment.

Considering the above-mentioned circumstances and already occurrence of a failure, **you are requested to kindly look into the matter on priority and arrange to take up necessary action** including thorough patrolling of aforesaid lines **to ensure the rectification of defects and maintain healthiness of transmission system** elements installed at POWERGRID Baghpat GIS Station, so that uninterrupted power supply may be extended to UPPTCL substations.

Looking forward for a prompt & positive action and continued support from your end.

Regards,  
Abhishek Shasta  
DGM-Baghpat SS, POWERGRID



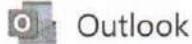

---

**Frequent tripping of 220 kV Baghpat- Shamli line of UPPTCL -reg.**

---

From Mayank Rana (मयंक राणा) <ranamayank11@powergrid.in>

Date Thu 9/7/2023 12:11 PM

To eeetdshamli@upptcl.org <eeetdshamli@upptcl.org>

Cc cetw@upptcl.org <cetw@upptcl.org>; seetcmzn@upptcl.org <seetcmzn@upptcl.org>; rtamc.nr1 <rtamc.nr1@powergrid.in>; gisbaghpat <gisbaghpat@powergrid.in>; Rajeev Kumar (राजीव कुमार) <Rajivkumar@powergrid.in>; Ashok Kumar Behera (ए.के. बेहरा) <akbehera@powergrid.in>; Abhishek Shasta (अभिषेक शास्ता) <abhishek.shasta@powergrid.in>; Hemraj Lodha (एच.आर. लोढ़ा) <hrlodha@powergrid.in>; rtamc.nr1 <rtamc.nr1@powergrid.in>; Sandeep Yadav (संदीप यादव) <sandeepyadav@powergrid.in>; Neeraj Kumar (नीरज कुमार) <Neerajk@powergrid.in>

Dear Sir,

In continuation to the earlier letters and trailing email, it is to once again inform you that the 220 kV Baghpat (POWERGRID)-Shamli (UPPTCL) Transmission line **owned by UPPTLC** is tripping/auto-reclosing very frequently due to transient and permanent faults.

In spite of giving regular reminders over email, letters and telephonically, the defects persisting in this transmission line is causing frequent tripping of line.

You are already aware that these unwarranted frequent trippings are causing **flow of heavy fault current through connected 400/220 kV ICTs and the respective bay also, which is adversely affecting equipment life.**

These frequent faults have **already caused failure of GIS circuit breaker of this line, which reduced the availability and moreover added financial burden on the owner.** POWERGRID substation at Baghpat is based on advance GIS technology loaded with expensive equipment and POWERGRID can not afford such frequent feeding of fault current through its ICT & other equipment.

The said transmission line tripped on persisting fault 06.09.2023 with FLR: 3.9 km/13kA and again tripped on persisting fault on 07.09.2023 with FLR: 3.8 km / 10 kA. **The FLR indicates defect at the same location** and that the **charging of the line was done without carrying out the patrolling** and resolving the persisting issue.

In view of the above frequent trippings, you are requested to kindly **carry out a thorough patrolling of the line before providing charging clearance** of the line in order to avoid frequent tripping and unnecessary stress of the GIS system at POWERGRID, Baghpat.

Thanks and Regards  
Mayank Rana  
Dy. Manager,  
POWERGRID, Baghpat  
8439885495



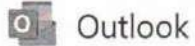

Outlook

---

**Frequent tripping of 220 kV Baghpat-Modipuram line of UPPTCL -reg.**

---

**From** Abhishek Shasta (अभिषेक शास्ता) </O=POWERGRID/OU=EXCHANGE ADMINISTRATIVE GROUP (FYDIBOHF23SPDLT)/CN=RECIPIENTS/CN=ABHISHEK SHASTA3B5>

**Date** Fri 3/31/2023 6:27 PM

**To** eeetdmrt@upptcl.org <eeetdmrt@upptcl.org>; setmrt@upptcl.org <setmrt@upptcl.org>

**Cc** Hemraj Lodha (एच.आर. लोढ़ा) <hrlodha@powergrid.in>; A K Behera (ए.के. बेहरा) <akbehera@powergrid.in>; Rajeev Kumar (राजीव कुमार) <Rajivkumar@powergrid.in>; Neeraj Kumar (नीरज कुमार) <Neerajk@powergrid.in>; 'RTAMC NR I' <rtamc.nr1@powergrid.co.in>; Mayank Rana (मयंक राणा) <ranamayank11@powergrid.in>; gisbaghpat@powergrid.co.in <gisbaghpat@powergrid.co.in>

1 attachment (4 MB)

upptcl modipuram letter.pdf;

Dear Sir,

It is to bring to your kind notice that circuit-1 of Baghpat (POWERGRID) - Modipuram(UPPTCL) 220kV transmission line of UPPTCL had tripped yesterday and again today due to transient and permanent faults thus feeding cumulative fault current of around 10-12 kAmps on 220 kV side within 24 hours at Baghpat GIS. In addition to this, the aforesaid line has tripped 5 times earlier and auto-reclosed 3 times during last six months (event details attached). These are newly commissioned transmission assets and we don't expect to experience such issues in such new lines.

You are already aware that frequent unwarranted trippings/auto-reclosures of transmission lines result in flow of heavy fault current through connected ICTs and other bay equipment at 400/220 kV GIS Baghpat of POWERGRID, thus adversely affecting equipment life. These high value faults in this transmission line is proving to be dangerously hazardous and extremely detrimental to the health of the connected system, which may even lead to equipment failure resulting in additional financial burden on the owner. POWERGRID substation at Baghpat is based on advance GIS technology loaded with expensive equipment and the company can not afford such frequent feeding of fault current through its ICTs & other equipment.

Considering the above-mentioned circumstances, you are once again requested to kindly look into the matter on priority and arrange to take up necessary action including thorough patrolling of aforesaid line with a view to ensure the healthiness of transmission system.

In the unlikely event of such frequent trippings occurring repeatedly, POWERGRID shall be forced to set the auto-reclosure in this transmission line to 'OFF' condition as a temporary measure to prevent fault feeding in GIS system, till rectification of defects and confirmation of healthiness of line by UPPTCL.

Looking forward for a prompt & positive action and continued support from your end.

Regards,  
Abhishek Shasta  
DGM (Baghpat GIS), POWERGRID





Outlook

---

**Frequent tripping/auto-reclosure of 220 kV Baghpat- Baghpat line of UPPTCL on 19.12.2022 -reg.**

---

From Abhishek Shasta (अभिषेक शास्ता) </O=POWERGRID/OU=EXCHANGE ADMINISTRATIVE GROUP (FYDIBOHF23SPDLT)/CN=RECIPIENTS/CN=ABHISHEK SHASTA3B5>

Date Mon 12/19/2022 6:37 PM

To eeetdbaraut@upptcl.org <eeetdbaraut@upptcl.org>

Cc A K Behera (ए.के. बेहरा) <akbehera@powergrid.in>; Rajeev Kumar (राजीव कुमार) <Rajivkumar@powergrid.in>; Neeraj Kumar (नीरज कुमार) <Neerajk@powergrid.in>; Sandeep Yadav (संदीप यादव) <sandeepyadav@powergrid.in>; 'RTAMC NR I' <rtamc.nr1@powergrid.co.in>; Mayank Rana (मयंक राणा) <ranamayank11@powergrid.in>; gisbaghpat@powergrid.co.in <gisbaghpat@powergrid.co.in>

1 attachment (121 KB)

Trip-AR details (19.12.2022) - baghpat.pdf;

Dear Sir,

You must be aware that circuit-1 of Baghpat(POWERGRID) - Baghpat(UPPTCL) 220kV transmission line of UPPTCL had tripped today morning while circuit-2 auto-reclosed six times due to transient and permanent faults thus feeding cumulative fault current of around 80 kAmps on 220 kV side within 3 hours at Bagpat GIS (**event details attached**).

You are already aware that frequent unwarranted trippings/auto-reclosures of transmission line result in flow of heavy fault current through connected 400/220 kV ICTs and other bay equipment at GIS Baghpat of POWERGRID, thus adversely affecting equipment life. These high value faults in this transmission line is proving to be dangerously hazardous and extremely detrimental to the health of the connected system, which may even lead to equipment failure resulting in additional financial burden on the owner. POWERGRID substation at Baghpat is based on advance GIS technology loaded with expensive equipment and the company can not afford such frequent feeding of fault current through its ICT & other equipment.

You are also aware that this line has been experiencing similar high value fault conditions for long time now and the issue has been taken up with UPPTCL as required. The issue of such frequent trippings of UPPTCL lines has further been deliberated in recently concluded 201<sup>st</sup> OCC Meeting of NRPC wherein UPPTCL has been directed to rectify the defects in its system in order to ensure stability and healthiness of both grid and Baghpat GIS.

In line with above, it may be informed that the auto-reclosure in this transmission line is being set to 'OFF' condition as a temporary measure to prevent fault feeding in GIS system, till rectification of defects and confirmation of healthiness of line by UPPTCL.

Considering the above-mentioned circumstances, you are once again requested to kindly look into the matter on priority and arrange to take up necessary action with a view to ensure the healthiness of transmission system.

Looking forward for a prompt & positive action and continued support from your end.

-  
Regards,  
Abhishek Shasta  
DGM (Baghpat GIS), POWERGRID



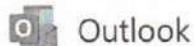

## Frequent tripping/auto-reclosure of 220 kV Baghpat- Mandola Vihar line of UPPTCL on 19.12.2022 - reg.

From Abhishek Shasta (अभिषेक शास्ता) </O=POWERGRID/OU=EXCHANGE ADMINISTRATIVE GROUP (FYDIBOHF23SPDLT)/CN=RECIPIENTS/CN=ABHISHEK SHASTA3B5>

Date Mon 12/19/2022 6:29 PM

To eeetd1gzb@upptcl.org <eeetd1gzb@upptcl.org>

Cc A K Behera (ए.के. बेहरा) <akbehera@powergrid.in>; Rajeev Kumar (राजीव कुमार) <Rajivkumar@powergrid.in>; Neeraj Kumar (नीरज कुमार) <Neerajk@powergrid.in>; Sandeep Yadav (संदीप यादव) <sandeepyadav@powergrid.in>; 'RTAMC NR I' <rtamc.nr1@powergrid.co.in>; Mayank Rana (मयंक राणा) <ranamayank11@powergrid.in>; gisbaghpat@powergrid.co.in <gisbaghpat@powergrid.co.in>

1 attachment (109 KB)

Trip-AR details (19.12.2022) - mandola vihar.pdf;

Dear Sir,

You must be aware that Baghpat(POWERGRID) - Mandola Vihar(UPPTCL) 220kV transmission line of UPPTCL had tripped today morning after auto-reclosing twice due to transient and permanent faults thus feeding cumulative fault current of around 20 kAmps on 220 kV side within 2 hours at Bagpat GIS (event details attached).

You are already aware that frequent unwarranted trippings/auto-reclosures of transmission line result in flow of heavy fault current through connected 400/220 kV ICTs and other bay equipment at GIS Baghpat of POWERGRID, thus adversely affecting equipment life. These high value faults in this transmission line is proving to be dangerously hazardous and extremely detrimental to the health of the connected system, which may even lead to equipment failure resulting in additional financial burden on the owner. POWERGRID substation at Baghpat is based on advance GIS technology loaded with expensive equipment and the company can not afford such frequent feeding of fault current through its ICT & other equipment.

You are also aware that this line has been experiencing similar high value fault conditions for long time now and the issue has been taken up with UPPTCL time & again. The issue of such frequent trippings of UPPTCL lines has further been deliberated in recently concluded 201<sup>st</sup> OCC Meeting of NRPC wherein UPPTCL has been directed to rectify the defects in its system in order to ensure stability and healthiness of both grid and Baghpat GIS.

In line with above, it may be informed that the auto-reclosure in this transmission line is being set to 'OFF' condition as a temporary measure to prevent fault feeding in GIS system, till rectification of defects and confirmation of healthiness of line by UPPTCL.

Considering the above-mentioned circumstances, you are once again requested to kindly look into the matter on priority and arrange to take up necessary action with a view to ensure the



healthiness of transmission system.

Looking forward for a prompt & positive action and continued support from your end.

Regards,

Abhishek Shasta

DGM (Baghpat GIS), POWERGRID

---

**From:** Abhishek Shasta {अभिषेक शास्ता}

**Sent:** 31 October 2022 15:19

**To:** 'eeetd1gzb@upptcl.org' <eeetd1gzb@upptcl.org>

**Cc:** 'cetw@upptcl.org' <cetw@upptcl.org>; 'setgzb@upptcl.org' <setgzb@upptcl.org>; 'RTAMC NR 1' <rtamc.nr1@powergrid.co.in>; 'gisbaghpat@powergrid.co.in' <gisbaghpat@powergrid.co.in>; Mayank Rana {मयंक राणा} <ranamayank11@powergrid.in>; Rajeev Kumar {राजीव कुमार} <Rajivkumar@powergrid.in>; A K Behera {ए.के. बेहरा} <akbehera@powergrid.in>; Sanjay Sharma {संजय शर्मा} <sanjay\_sharma@powergrid.in>

**Subject:** Frequent auto-reclosure of 220 kV Baghpat- Mandola Vihar line of UPPTCL -reg.

Dear Sir,

In continuation to our earlier correspondence on the subject matter, it is once again informed that in recent past the Baghpat(POWERGRID) – Mandola Vihar(UPPTCL) 220kV transmission line of UPPTCL is tripping/auto-reclosing very frequently due to transient and permanent faults. The transmission line is proving to be dangerously hazardous as is evident from the fact that this line has actually auto reclosed 15 times and tripped once during last 1 year (list enclosed). You will appreciate that such occurrences result in problems for not just UPPTCL but POWERGRID and Outage Management Units as well.

You are already aware that such frequent unwarranted trippings/auto-reclosures of transmission line result in flow of heavy fault current through connected 400/220 kV ICTs and other bay equipment at GIS Baghpat of POWERGRID, thus adversely affecting equipment life. This may even lead to equipment failure resulting in additional financial burden on the owner. POWERGRID substation at Baghpat is based on advance GIS technology loaded with expensive equipment and POWERGRID can not afford such frequent feeding of fault current through its ICT & other equipment.

Further, it has also been informed several times in the past that the PLCC panel of UPPTCL installed at Baghpat station is not in healthy condition thus resulting in more time of fault feeding in case the fault is in 80%-100% zone of the line, as in such scenario we do not receive any carrier due to non-healthiness of the PLCC panel of UPPTCL. This has been faulty for a long period now and requires immediate repair/replacement, or else POWERGRID will be forced to reduce its Zone-02 timing to zero(0) msec. in order to reduce the fault feeding time.

Considering the above-mentioned circumstances, you are once again requested to kindly look into the matter on priority and arrange to take up necessary action including thorough patrolling of aforesaid line and restoring the healthiness of your PLCC panel with a view to ensure the healthiness of transmission system elements installed at POWERGRID Baghpat GIS Station.

Looking forward for a prompt & positive action and continued support from your end.

*P.S.: Scanned copy of letter attached herewith*

Regards,  
Abhishek Shasta  
DGM (Baghpat GIS), POWERGRID



## Mayank Rana (मयंक राणा)

**From:** Mayank Rana (मयंक राणा)  
**Sent:** Sunday, October 30, 2022 11:23 AM  
**To:** eeetd1gzb@upptcl.org; eeetd2gzb@upptcl.org; eeetdmrd@upptcl.org  
**Cc:** cetw@upptcl.org; setgzb@upptcl.org; rtamc.nr1@powergrid.co.in; A K Behera (ए.के. बेहरा); Abhishek Shasta (अभिषेक शास्ता)  
**Subject:** Regarding emergency patrolling of 220 kV Baghpat(PG)-Mandola Vihar(UP) line in view of recent trippings

Dear Sir,

It is to inform you that the 220kV Baghpat (POWERGRID) - Mandola Vihar (UPPTCL) transmission line of UPPTCL have auto-reclosed three (03) times already since last night as detailed below:-

S.No.	Date	Fault Details			Category
		Parameter	M1	M2	
1	29-Oct-22	Phase	Y-G	L2-N	A/R
		Distance (km)	11.5	11.3	
		Current (kA)	9.04	9.916	
		Zone	1	1	
2	30-Oct-22	Phase	R-G	L1-N	A/R
		Distance (km)	10.3	10.2	
		Current (kA)	10.57	10.45	
		Zone	1	1	
3	30-Oct-22	Phase	B-G	L3-N	A/R
		Distance (km)	6.6	6.6	
		Current (kA)	12.91	12.91	
		Zone	1	1	

You will appreciate that such occurrences result in problems for not just UPPTCL, but RTAMC and POWERGRID alike.

You are already aware that such unwarranted tripping of transmission line result in flow of heavy fault current through connected 400/220 kV ICTs and other bay equipment at GIS Baghpat of POWERGRID, thus adversely affecting equipment life. POWERGRID substation at Baghpat is based on advance GIS technology & loaded with expensive equipment; and POWERGRID cannot afford such frequent feeding of fault current through its ICT & other equipment.

Considering the above-mentioned circumstances, you are requested to kindly look into the matter on priority and arrange emergency patrolling of the abovementioned transmission line with a view to ensure the healthiness of transmission system elements installed at POWERGRID Baghpat GIS Station.

Looking forward for a prompt & positive action and continued support from your end.





---

**Frequent tripping of 220 kV Baghpat- Shamli line of UPPTCL -reg.**

---

From Abhishek Shasta (अभिषेक शास्ता) </O=POWERGRID/OU=EXCHANGE ADMINISTRATIVE GROUP (FYDIBOHF23SPDLT)/CN=RECIPIENTS/CN=ABHISHEK SHASTA3B5>

Date Thu 10/20/2022 12:47 PM

To eeetdshamli@upptcl.org <eeetdshamli@upptcl.org>

Cc cetw@upptcl.org <cetw@upptcl.org>; seetcmzn@upptcl.org <seetcmzn@upptcl.org>; 'RTAMC NR I' <rtamc.nr1@powergrid.co.in>; gisbaghpat@powergrid.co.in <gisbaghpat@powergrid.co.in>; Mayank Rana (मयंक राणा) <ranamayank11@powergrid.in>; Rajeev Kumar (राजीव कुमार) <Rajivkumar@powergrid.in>; A K Behera (ए.के. बेहरा) <akbehera@powergrid.in>; Sanjay Sharma (संजय शर्मा) <sanjay\_sharma@powergrid.in>

📎 1 attachment (4 MB)

Shamli Line Tripping Letter -201022.pdf;

Dear Sir,

In continuation to our earlier letters on the subject matter, it is once again informed that in recent past the Baghpat(POWERGRID) - Shamli(UPPTCL) 220kV transmission line of UPPTCL is tripping/auto-reclosing very frequently due to transient and permanent faults. **The transmission line is proving to be dangerously hazardous as is evident from the fact that this line has actually tripped 10 times since April 2022 and auto-reclosed 22 times (list enclosed).** You will appreciate that such occurrences result in problems for not just UPPTCL but POWERGRID and Outage Management Units as well.

You are already aware that such frequent unwarranted trippings of transmission line result in flow of heavy fault current through connected 400/220 kV ICTs and other bay equipment at GIS Baghpat of POWERGRID, thus adversely affecting equipment life. This may even result in equipment failure resulting in additional financial burden on the owner. POWERGRID substation at Baghpat is based on advance GIS technology loaded with expensive equipment and **POWERGRID can not afford such frequent feeding of fault current through its ICT & other equipment.**

Further, it has also been informed several times in the past that the **PLCC panel of UPPTCL installed at Baghpat station is not in healthy condition** thus resulting in more time of fault feeding in case the fault is in 80%-100% zone of the line, as in such scenario we do not receive any carrier due to non-healthiness of the PLCC panel of UPPTCL. This has been faulty for a long period now and requires immediate repair/replacement, or else **POWERGRID will be forced to reduce its Zone-02 timing to zero(0) msec. in order to reduce the fault feeding time.**

Considering the above-mentioned circumstances, you are once again requested to kindly look into the matter on priority and arrange to take up necessary action including thorough patrolling of aforesaid line and restoring the healthiness of your PLCC panel with a view to ensure the healthiness of transmission system elements installed at POWERGRID Baghpat GIS Station.

Looking forward for a prompt & positive action and continued support from your end.

*P.S.: Scanned copy of letter attached herewith*

Regards,  
Abhishek Shasta  
DGM (Baghpat GIS), POWERGRID



Outlook

---

**Frequent tripping of 220 kV Baghpat- Shamli line of UPPTCL -reg.**

---

**From** Abhishek Shasta (अभिषेक शास्ता) </O=POWERGRID/OU=EXCHANGE ADMINISTRATIVE GROUP (FYDIBOHF23SPDLT)/CN=RECIPIENTS/CN=ABHISHEK SHASTA3B5>

**Date** Mon 8/1/2022 1:32 PM

**To** seetcmzn@upptcl.org <seetcmzn@upptcl.org>; eeetdshamli@upptcl.org <eeetdshamli@upptcl.org>

**Cc** Mayank Rana (मयंक राणा) <ranamayank11@powergrid.in>; Rajeev Kumar (राजीव कुमार) <Rajivkumar@powergrid.in>; A K Behera (ए.के. बेहरा) <akbehera@powergrid.in>; Sanjay Sharma (संजय शर्मा) <sanjay\_sharma@powergrid.in>; gisbaghpat@powergrid.co.in <gisbaghpat@powergrid.co.in>; RTAMC NR I <rtamc.nr1@powergrid.co.in>

 1 attachment (263 bytes)

Archived attachment list.txt;







---

**Regarding frequent tripping of 220 kV Baghpat (PG) - Shamli (UPPTCL) line**

---

**From** gisbaghpatpowergrid <gisbaghpat@powergrid.co.in>

**Date** Mon 06-06-2022 17:02

**To** eeetdshamli <eeetdshamli@upptcl.org>

**Cc** director\_sldc@upptcl.org <director\_sldc@upptcl.org>; sanjay sharma <sanjay\_sharma@powergrid.in>

 1 attachment (566 KB)

Letter UPPTCL Shamli.pdf;

Dear Sir,

PFA the letter regarding subject cited above. The letter is self explanatory.

You are requested to kindly take necessary action please.

Thanks and Regards

Mayank Rana

Dy. Manager, Baghpat



Ref: NR-1/AM/UPPTCL/Tripping

Dt. 03.12.2024

To,

**Chief Engineer (Transmission West, UPPTCL, Meerut)  
Victoria Park, Ramgarhi, Meerut, Uttar Pradesh. Pin-250001****Subject: Request for Investigation into Frequent Faults in 220kV Lines Connected to Meerut (PG) Substation**

Dear Sir,

We would like to bring to your attention the frequent faults in the UPPTCL portion on the five 220kV lines connected to the Meerut Substation. The fault details over the last two years are summarized below:

Sr. No.	Name of the lines	No. of Faults in Last Two Years
1	220kV MEERUT-NARA	56
2	220kV MEERUT-SIMBHOLI	24
3	220kV MEERUT-MODIPURAM-1 & 2	20
4	220kV MEERUT-SHATABDINAGAR	14

These recurring faults have placed significant stress on the switchyard equipment, conductors/droppers, and ICTs connected to the Meerut Substation. Furthermore, the frequent faults on the 220kV Meerut-Nara line have led to the failure of CB earlier. The repeated fault clearance by the CB has caused decomposition of SF6 gas in the arc-interrupting chamber, ultimately rendering the CB unable to clear the faults effectively.

Given the critical importance of ensuring a reliable electricity supply, we kindly request your team to conduct a thorough investigation to identify and address the root causes of these frequent faults in the mentioned lines.

**Please note that if the issue of frequent fault feeding is not urgently addressed on the UPPTCL side, POWERGRID may be compelled to review its auto-reclosing (AR) settings.**

We trust that your team will prioritize this matter and take the necessary corrective measures to resolve the issue. We look forward to your prompt action and continued support in this regard.

  
**Kuleshwar Sahu  
CGM-AM, NR1 Gr-1**

**Encl:** 1. Details of faults in last two years

**DETAILS OF TRIPPING OF 220KV LINE CONNECTED TO MEERUT (PG) SUBSTATION**

Sr. No.	Name of Lines	Tripping Date	Tripping Time	Fault Current	Faulty-Phase	Fault Location from Meerut end
1	220kV MEERUT-SIMBHOLI(UPPTCL)	09.01.2023	12:59:00	13.949 KA	Y-N	10.295 KM
2	220kV MEERUT-NARA(UPPTCL)	11-02-2023	16:10:00	16.16 KA	B-N	1.132 KM
3	220kV MEERUT-MODIPURAM(UPPTCL)-1	19-02-2023	05:29:00	12.18 KA	Y-N	10.18 KM
4	220kV MEERUT-MODIPURAM(UPPTCL)-2	19-02-2023	05:29:00	10.14 KA	Y-N	9.89 KM
5	220kV MEERUT-NARA(UPPTCL)	22-02-2023	11:32:00	5.7 KA	B-N	29.92 KM
6	220kV MEERUT-NARA(UPPTCL)	20-03-2023	15:46:00	11.80 KA	R-N	12.242KM
7	220kV MEERUT-NARA(UPPTCL)	28-03-2023	07:31:00	11.95 KA	B-N	13.31 KM
8	220kV MEERUT-NARA(UPPTCL)	08-04-2023	22:43:00	17.71 KA	Y-N	6.4 KM
9	220kV MEERUT-NARA(UPPTCL)	08-04-2023	21:41:00	17.97 KA	Y-N	6.49 KM
10	220kV MEERUT-SIMBHOLI(UPPTCL)	10-04-2023	20:52:00	13.5 KA	Y-N	10.27 KM
11	220kV MEERUT-NARA(UPPTCL)	11-04-2023	01:54:00	14.6 KA	B-N	8.62 KM
12	220kV MEERUT-SHATABDINAGAR(UPPTCL)	24-04-2023	11:23:00	7.818 KA	B-N	20.12 KM
13	220kV MEERUT-NARA(UPPTCL)	25-04-2023	05:48:00	10.09 KA	Y-N	16.17 KA
14	220kV MEERUT-NARA(UPPTCL)	05-05-2023	01:49:00	12.86 KA	Y-N	9.81 KM
15	220kV MEERUT-NARA(UPPTCL)	07-05-2023	22:41:00	17.2 KA	Y-N	6.56 KM
16	220kV MEERUT-NARA(UPPTCL)	08-05-2023	20:28:00	16.47 KA	Y-N	6.608KM
17	220kV MEERUT-NARA(UPPTCL)	24-05-2023	03:53:00	13.3 KA	B-N	10.83KM
18	220kV MEERUT-NARA(UPPTCL)	26-05-2023	18:36:00	9.637 KA	B-N	15.677KM
19	220kV MEERUT-NARA(UPPTCL)	31-05-2023	13:56:00	5.867 KA	B-N	30.111KM
20	220kV MEERUT-NARA(UPPTCL)	08-06-2023	08:55:00	15.9 KA	B-N	6.611KM
21	220kV MEERUT-NARA(UPPTCL)	10-06-2023	10:41:00	9.81 KA	R-N	27.545KM
22	220kV MEERUT-SIMBHOLI(UPPTCL)	22-06-2023	18:19:00	4.54 KA	R-N	42.776KM
23	220kV MEERUT-NARA(UPPTCL)	24-06-2023	19:46:00	41.12 KA	Y-N	0.025KM
24	220kV MEERUT-NARA(UPPTCL)	27-06-2023	13:39:00	6.87 KA	B-N	23.4KM
25	220kV MEERUT-NARA(UPPTCL)	01-07-2023	19:01:00	9.583 KA	R-N	15.707KM
26	220kV MEERUT-NARA(UPPTCL)	09-07-2023	18:35:00	7.875 KA	R-N	21.213KM
27	220kV MEERUT-NARA(UPPTCL)	14-07-2023	15:14:00	9.635 KA	R-N	14.618KM
28	220kV MEERUT-NARA(UPPTCL)	17-07-2023	05:53:00	9.907 KA	R-N	17.557KM
29	220kV MEERUT-SIMBHOLI(UPPTCL)	17-07-2023	17:42:00	4.739 KA	R-N	42.591KM
30	220kV MEERUT-NARA(UPPTCL)	26-07-2023	05:30:00	3.086 KA	R-N	32KM
31	220kV MEERUT-NARA(UPPTCL)	26-07-2023	09:47:00	12469 KA	R-N	12.16KM
32	220kV MEERUT-NARA(UPPTCL)	28-07-2023	07:12:00	2.817 KA	R-N	32KM
33	220kV MEERUT-SIMBHOLI(UPPTCL)	04-08-2023	11:36:00	4.7 KA	R-N	39.33KM
34	220kV MEERUT-NARA(UPPTCL)	04-08-2023	12:32:00	6.52 KA	R-N	29.6KM
35	220kV MEERUT-SHATABDINAGAR(UPPTCL)	07-08-2023	15:49:00	6.834 KA	R-N	29.676KM
36	220kV MEERUT-MODIPURAM(UPPTCL)-1	10-08-2023	13:04:00	6.076 KA	R-N	14.442KM
37	220kV MEERUT-NARA(UPPTCL)	15-08-2023	18:07:00	13.684 KA	R-N	10.012KM
38	220kV MEERUT-SHATABDINAGAR(UPPTCL)	17-08-2023	05:17:00	16.936 KA	B-N	6.416KM
39	220kV MEERUT-NARA(UPPTCL)	06-09-2023	09:56:00	11.546 KA	B-N	12.223KM
40	220kV MEERUT-NARA(UPPTCL)	24-09-2023	15:37:00	7.368 KA	R-N	21473KM
41	220kV MEERUT-SIMBHOLI(UPPTCL)	01-10-2023	10:21:00	6.578 KA	Y-N	23.841KM
42	220kV MEERUT-NARA(UPPTCL)	10-10-2023	12:44:00	15.698 KA	Y-N	3.628KM
43	220kV MEERUT-SIMBHOLI(UPPTCL)	10-10-2023	10:27:00	6.323 KA	Y-N	27.268KM
44	220kV MEERUT-NARA(UPPTCL)	14-10-2023	10:37:00	16.068 KA	Y-N	3.852KM
45	220kV MEERUT-SIMBHOLI(UPPTCL)	15-10-2023	16:02:00	7.763 KA	Y-N	22.193KM
46	220kV MEERUT-SIMBHOLI(UPPTCL)	17-10-2023	12:10:00	8.501 KA	Y-N	18.489KM
47	220kV MEERUT-SIMBHOLI(UPPTCL)	22-10-2023	09:43:00	4.332 KA	R-N	46.838KM
48	220kV MEERUT-NARA(UPPTCL)	26-12-2023	04:39:00	6.142 KA	R-N	27.642KM
49	220kV MEERUT-NARA(UPPTCL)	16-04-2024	02:27:00	7.272 KA	B-N	22.239KM
50	220kV MEERUT-NARA(UPPTCL)	16-04-2024	05:50:00	14.03 KA	Y-N	9.8KM
51	220kV MEERUT-NARA(UPPTCL)	26-04-2024	06:48:00	13.992 KA	Y-N	8.4KM
52	220kV MEERUT-NARA(UPPTCL)	26-04-2024	04:22:00	14.27 KA	Y-N	8.521KM
53	220kV MEERUT-SIMBHOLI(UPPTCL)	02-05-2024	23:48:00	6.841 KA	B-R	33.286KM
54	220kV MEERUT-SIMBHOLI(UPPTCL)	14-05-2024	18:39:00	10.89 KA	Y-N	15.187KM
55	220kV MEERUT-SHATABDINAGAR(UPPTCL)	31-05-2024	12:17:00	6.738 KA	Y-N	32.334KM

56	220kV MEERUT-SIMBHOLI(UPPTCL)	09-07-2024	09:14:00	5.687 KA	Y-B	43.713KM
57	220kV MEERUT-NARA(UPPTCL)	15-07-2024	03:40:00	9.16 KA	R-N	17.18 KM
58	220kV MEERUT-NARA(UPPTCL)	15-07-2024	05:18:00	11.87 KA	R-N	
59	220kV MEERUT-NARA(UPPTCL)	15-07-2024	05:18:00	13.18 KA	R-N	
60	220kV MEERUT-MODIPURAM(UPPTCL)-1	17-07-2024	12:40:00	6.52 KA	R-N	8.5KMKM
61	220kV MEERUT-SIMBHOLI(UPPTCL)	17-07-2024	23:11:00	6.643 KA	R-N	24.295KM
62	220kV MEERUT-NARA(UPPTCL)	18-07-2024	08:57:00	6.857 KA	Y-N	24.454KM
63	220kV MEERUT-MODIPURAM(UPPTCL)-2	24-07-2024	07:16:00	13.636 KA	R-N	10.21KM
64	220kV MEERUT-MODIPURAM(UPPTCL)-2	25-07-2024	13:30:00	16.18 KA	B-N	
65	220kV MEERUT-MODIPURAM(UPPTCL)-1	31-07-2024	20:18:00	26.341 KA	R-N	1.83KM
66	220kV MEERUT-NARA(UPPTCL)	11-08-2024	18:25:00	14.056 KA	B-N	10.565KM
67	220kV MEERUT-SIMBHOLI(UPPTCL)	12-08-2024	10:56:00	4.555 KA	R-N	38.156KM
68	220kV MEERUT-MODIPURAM(UPPTCL)-2	15-08-2024	17:35:00	13.76 KA	R-N	10.678KM
69	220kV MEERUT-SHATABDINAGAR(UPPTCL)	06-09-2024	21:05:00	13.157 KA	B-N	10.89KM
70	220kV MEERUT-NARA(UPPTCL)	11-09-2024	09:40:00	7.469 KA	R-N	24.567KM
71	220kV MEERUT-NARA(UPPTCL)	13-09-2024	00:01:00	7.32 KA	Y-N	22.68KM
72	220kV MEERUT-SIMBHOLI(UPPTCL)	29-09-2024	16:12:00	8.137 KA	R-N	19.841KM
73	220kV MEERUT-MODIPURAM(UPPTCL)-2	02-10-2024	23:27:00	29.75 KA	R-N	1.503KM
74	220kV MEERUT-MODIPURAM(UPPTCL)-1	08-10-2024	02:02:00	3.9 KA		67.33KM
75	220kV MEERUT-MODIPURAM(UPPTCL)-2	17-10-2024	10:03:00	5.765 KA	R-N	5.845KM
76	220kV MEERUT-NARA(UPPTCL)	20-10-2024	14:48:00	16.91 KA	Y-N	3.46KM
77	220kV MEERUT-NARA(UPPTCL)	21-10-2024	14:48:00	16.91 KA	Y-N	3.46KM
78	220kV MEERUT-SHATABDINAGAR(UPPTCL)	29-10-2024	00:12:00	16.46 KA	B-N	7.55KM
79	220kV MEERUT-SHATABDINAGAR(UPPTCL)	05-11-2024	03:37:00	12.766 KA	R-N	11.32 KM



---

## Frequent Faults on 220kV Lines at Meerut Substation

---

**From** Pankaj Kumar Jha {पंकज कुमार झा} <pankaj.jha@powergrid.in>

**Date** Wed 2024-12-04 15:25

**To** cetw@upptcl.org <cetw@upptcl.org>

**Cc** eeetdmrt@gmail.com <eeetdmrt@gmail.com>; setmrt@upptcl.org <setmrt@upptcl.org>; dharmendra.cea@gov.in <dharmendra.cea@gov.in>; Reeturaj Pandey <pandeyr.cea@gov.in>; Sh Singh <ms-nrpc@nic.in>; Santosh Kumar <seo-nrpc@nic.in>; LokeshAgrawal <lokesh.cea@gov.in>; Kuleshwar Sahu {कुलेश्वर साहू} <kuleshwar@powergrid.in>; M Thirumala Reddy {एम. तिरूमाला रेड्डी} <thirumalareddy@powergrid.in>; Ravi Wadyalkar {रवि अशोक वाड्यालकर} <wravi@powergrid.in>; Ankit Vaish {अंकित वैश्य} <ankit\_vaish@powergrid.in>; ccprotection <ccprotection@powergrid.in>; deepak.kr@grid-india.in <deepak.kr@grid-india.in>; Kritika Chopra {कृतिका चोपड़ा} <kritika.chopra@powergrid.in>; Neeraj Kumar {नीरज कुमार} <Neerajk@powergrid.in>; Randhir Singh {रणधीर सिंह} <Randhir@powergrid.in>; Manpreet Singh {मनप्रीत सिंह} <manpreet@powergrid.in>; Rajib Lochan Jena {राजीव लोचन जेना} <lochan@powergrid.in>

 2 attachments (3 MB)

Letter\_UPPTCL\_Meerut Tripping.pdf; Tripping of 220kV Lines Connected to Meerut Substation.pdf;

Dear Sir,

Please find attached the letter regarding frequent faults on the UPPTCL portion of the 220kV lines connected to the Meerut Substation, which are stressing the equipment and ICTs.

We request a prompt investigation to identify the root causes. **If unresolved, POWERGRID may review its AR settings.**

Warm Regards

Pankaj Kumar Jha

Chief Manager (Asset Management)

Power Grid Corporation of India Limited

Regional Headquarters, Northern Region-1

SCO Bay No.5 -10, Sector-16A, Faridabad, Haryana-121002

Mob: +919634440125



Ref: NR-1/AM/HVPNL/Tripping

Dt. 02.12.2024

To,

Chief Engineer

TS Circle, HVPNL

Vidyut Nagar, Hisar

Haryana-125044

Subject: **Urgent Attention Required Regarding Frequent Auto-Reclosing and Tripping on 220kV Hisar-Fatehabad Line**

Dear Sir,

With reference to our regular communication via phone and email with XENNAE-TL: Fatehabad from our Hisar Substation, as well as the letters dated 03.08.2023 addressed to XEN, HVPNL Fatehabad, letter dated 05.09.2023 & 12.08.2024 addressed to XEN, HVPNL Fatehabad, and letter dated 05.09.2024 addressed to SE, TS Circle, HVPNL, I am writing to express our ongoing concern regarding the frequent auto-reclosing (AR) and tripping incidents occurring on the 220kV Hisar-Fatehabad line, which is associated with the POWERGRID Hisar transmission substation.

**In the last two years, more than 60 fault incidents have been recorded on the 220kV Hisar-Fatehabad line-1, and more than 45 fault incidents on 220kV Hisar-Fatehabad line-2.** These disruptions have become increasingly frequent, resulting in significant hotspots and damage to conductors at our substations, particularly in the 220kV sections, in addition to stress and damage to other electrical equipment. Given the importance of maintaining a reliable electricity supply, we kindly request that your team conduct a thorough investigation to identify the root causes of the frequent tripping and AR events.

Despite our previous requests to address the issue of frequent tripping and auto-reclosure, the situation has not improved significantly in these two lines. Please note that if the issue of frequent fault feeding is not urgently addressed from the HVPNL side, **POWERGRID will be compelled to review its AR settings.** We trust that your team will prioritize this matter and take appropriate measures to resolve the ongoing issues.

We look forward to your prompt and positive action and continued support in this regard.



**Kuleshwar Sahu**  
CGM-AM, NR1 Gr-1

**Encl:** 1. All communications from Hissar Substations  
2. Copy of e-mail sent to Grid-India

**Copy to:** 1. Member Secretary, NRPC (E-mail: ms-nrpc@nic.in)  
2. SEO, NRPC (E-mail: seo-nrpc@nic.in)  
3. NRLDC SO2 (E-mail: nrldcso2@grid-india.in)

**Copy for kind information:**

1. Executive Director (NR-1), POWERGRID
2. CGM-I/C CC-AM, POWERGRID





**पावरग्रिड  
POWERGRID**

पावर ग्रिड कॉर्पोरेशन ऑफ इंडिया लिमिटेड  
(पावर ग्रिड का उत्पन्न)  
**POWER GRID CORPORATION OF INDIA LIMITED**  
(A Government of India Enterprise)

400/220 KV Substation, V.P.O. Mayyar, NH 09, Distt. Hisar (HARYANA) 125044.  
E-mail: hisarssnr1@powergrid.co.in, Mob. 8295903705.  
CIN No. L40101DL1989GOI038121

Ref:NR1/HISAR/HVPNL-FBD/2024/03

Date: 04.11.2024

To,  
Chief Engineer  
TS Circle, HVPNL  
Vidyut Nagar, Hisar  
Haryana-125044

**Sub: Frequent A/R of 220kV Hisar (PG)- Fatehabad line-1 & 2 -reg**

Ref:

1. Our regular intimation to XEN/AE-TL: Fatehabad over phone and e-mail
2. Our letter dated 03.08.2023 addressed to XEN, HVPNL Fatehabad
3. Our letter ref no. NR1/HISAR/HVPNL-FBD/ dtd. 05.09.2023 addressed to XEN, HVPNL Fatehabad.
4. Our letter ref no. NR1/HISAR/HVPNL-FBD/2024/01 Dtd. 12.08.2024 addressed to XEN, HVPNL Fatehabad
5. Our letter ref no. NR1/HISAR/HVPNL-FBD/2024/02 Dtd. 05.09.2024 addressed to SE,TS Circle,HVPNL
6. Email to Grid India on dtd. 05.09.2024 through RTAMC Manesar,POWERGRID

Dear Sir,

I am writing to express our concern regarding the frequent auto-reclosing (AR) and tripping incidents occurring on the 220 kV Hisar-Fatehabad line, which is associated with the POWERGRID Hisar transmission substation. These disruptions have been increasingly frequent and are causing significant increase in number of hotspots and conductor damage at our sub-stations especially for 220kV parts besides stress/ damage to our other electrical equipments.

The details of recent A/R and Tripping details (after our last letter) are listed below from which it is observed that A/R and Trippings are happening on weekly basis:

Sl. No	Name of line	Date of tripping	Date of tripping	Phase	Fault current (KA)	Fault location (KM)	Remarks
1	220KV Fatehabad line-1	06.09.2024	05:06:26	B Ph	5.672	23.052	AR Successful
2		14.09.2024	21:18:00	Y Ph	6.605	19.956	AR Successful
3		24.09.2024	02:40:12	B Ph	4.723	31.011	AR Successful
4		24.09.2024	04:03:34	B Ph	4.655	30.779	AR Successful
5		02.10.2024	17:29:42	B Ph	4.529	35.805	Trip
6		19.10.2024	18:28:58	R PH	4.538	31.163	Trip
7		21.10.2024	17:27:49	B Ph	7.567	15.614	Trip
1	220KV Fatehabad line-2	20.10.2024	22:55:37	B Ph	6.651	20.153	AR Successful
2		24.10.2024	09:20:27	R Ph	8.189	13.559	Trip
3		26.10.2024	02:20:15	B Ph	5.273	31.684	AR Successful
4		30.10.2024	19:34:04	Y Ph	8.629	14.414	Trip
5		02.11.2024	01:23:36	R Ph	8.254	14.553	Trip

Also, past AR & tripping details are attached herewith this letter.

Given the importance of reliable electricity supply, we kindly request that your team undertake a thorough investigation to identify the root causes of the frequent tripping and AR events.

Page (1/2)

दिनेश चन्द्रा नैनवाल/Dinesh Chandra Nainwal  
वरिष्ठ उप महा प्रबन्धक/Sr. D.G.M.  
Power Grid Corporation of India  
400/220, KV Sub Station  
Hisar-125044 (Haryana)



**पावरग्रिड  
POWERGRID**

**पावर ग्रिड कॉर्पोरेशन ऑफ इंडिया लिमिटेड**  
(भारत सरकार का उद्यम)  
**POWER GRID CORPORATION OF INDIA LIMITED**  
(A Government of India Enterprise)

**400/220 KV Substation, V.P.O Mayyar, NH-09, Distt. Hisar (HARYANA)-125044.**  
E mail: hisarssur1@powergrid.co.in, Mob. 8295903705.  
CIN No. L40101DL1999GOI038121

Specifically, we would appreciate:

1. A detailed analysis of the factors contributing to the recurrent tripping and AR incidents on the 220kV Hisar-Fatehabad line.
2. Recommendations and corrective actions to enhance the reliability of the power supply in this area.

In spite of our earlier request to address this issue of Tripping/AR, same has not been resolved yet. You are once again requested to take remedial measures to avoid such Tripping and A/Rs on regular basis and inform this office.

We trust that your team will prioritize this matter and take appropriate measures to address the on-going challenges.

Thank you for your attention to this issue. We look forward to your prompt response.

Sincerely,

Thanking you.

Yours faithfully,

  
**Dinesh Chandra Nainwal** 4/11/2024  
**Sr. DGM, POWERGRID**  
दिनेश चन्द्रा नैनवाल/Dinesh Chandra Nainwal  
वरिष्ठ उप महा प्रबन्धक/Sr. D.G.M.  
Power Grid Corporation of India  
400/220. KV Sub Station  
Mayyar, Hisar-125044 (Haryana)

- Copy to
1. CGM (Cluster Head/ RHQ AM Faridabad)
  2. Superintendent Engineer, TS, HVPNL, Hisar
  3. Executive Engineer, HVPNL, 400kV Fatehabad



**TRIPPING DETAILS OF 220KV HISAR(PG)-FATEHABAD (HVPN) LINE-1**

Sl No	Name of line	Time of tripping	Date of tripping	Phase	Fault current(KA)	Fault location(KM)	Remarks
1	220KV Fatehabad 1	05:23:00	02.08.2022	Rph	3.91	38.23	A/R sucessful
2	220KV Fatehabad 1	04:58	03.08.222	Yph	4.006	40.68	A/R sucessful
3	220KV Fatehabad 1	22:21	04.08.2022	Yph	4.05	34.96	A/R sucessful
4	220KV Fatehabad 1	12:17	08.08.2022	Yph	4.21	33.51	A/R sucessful
5	220KV Fatehabad 1	04:16	15.08.2022	Rph	8.9	15.37	A/R sucessful
6	220KV Fatehabad 1	05:45	15.08.2022	Rph	4.32	41.64	A/R sucessful
7	220KV Fatehabad 1	00:39	19.08.2022	Rph	5.65	23.3	A/R sucessful
8	220KV Fatehabad 1	00:39	19.08.2022	Rph	4.38	31.4	A/R sucessful
9	220KV Fatehabad 1	18:59	27.08.2022	Rph	6.83	18.7	A/R sucessful
10	220KV Fatehabad 1	14:41	05.09.2022	Rph	3.72	49.21	A/R sucessful
11	220KV Fatehabad 1	02:42	14.09.2022	Rph	4.05	36.96	A/R sucessful
12	220KV Fatehabad 1	06:01	19.09.2022	Rph	4.25	34.97	A/R sucessful
13	220KV Fatehabad 1	09:04	21.09.2022	Bph	4.39	35.26	Tripped
14	220KV Fatehabad 1	03:53	25.09.2022	Rph	4.86	31.76	A/R sucessful
15	220KV Fatehabad 1	05:34	27.09.2022	Rph	4.15	38.43	A/R sucessful
16	220KV Fatehabad 1	21:32	27.09.2022	Yph	4.59	32.55	A/R sucessful
17	220KV Fatehabad 1	21:31	27.09.2022	Rph	5.16	26.31	A/R sucessful
18	220KV Fatehabad 1	01:29	28.09.2022	Rph	5.35	32.81	A/R sucessful
19	220KV Fatehabad 1	19:31	29.09.2022	Rph	3.86	41.1	A/R sucessful
20	220KV Fatehabad 1	02:06	09.10.2022	Rph	4.65	32.61	A/R sucessful
21	220KV Fatehabad 1	20:25	09.10.2022	Rph	4.26	37.13	A/R sucessful
22	220KV Fatehabad 1	23:17	10.10.2022	Yph	3.97	47.77	A/R sucessful
23	220KV Fatehabad 1	00:36	11.10.2022	Rph	5.45	26.468	A/R sucessful
24	220KV Fatehabad 1	03:18	12.10.2022	Rph	4.318	37.69	A/R sucessful
25	220KV Fatehabad 1	16:07	13.10.2022	Rph	3.83	40.94	A/R sucessful
26	220KV Fatehabad line-1	05:41:50	12.09.2023	B-ph	10.026	10.688	A/R sucessful
27	220KV Fatehabad line-1	03:02:16	03.09.2023	B-ph	4.154	37.295	A/R sucessful
28	220KV Fatehabad line-1	13:39:13	09.08.2023	R-ph	5.086	29.214	A/R sucessful
29	220KV Fatehabad line-1	23:26:04	02.08.2023	B-ph	3.3	51.94	A/R sucessful
30	220KV Fatehabad line-1	20:36:57	30.07.2023	Y-ph	4.258	37.01	A/R sucessful
31	220KV Fatehabad line-1	04:36:09	30.07.2023	R-ph	4.405	34.864	A/R sucessful
32	220KV Fatehabad line-1	03:25:27	30.07.2023	R-ph	8.937	13.487	A/R sucessful
33	220KV Fatehabad line-1	01:24:13	26.07.2023	Y-ph	4.955	30.892	A/R sucessful
34	220KV Fatehabad line-1	00:01:28	26.07.2023	R-ph	4.766	32.682	A/R sucessful
35	220KV Fatehabad line-1	04:13:33	24.05.2023	B-ph	4.939	30.673	A/R sucessful
36	220KV Fatehabad line-1	12:34:45	07.12.2023	R-ph	3.38	50.973	AR Sucessful
37	220KV Fatehabad line-1	04:18:31	26.10.2023	B Ph	15.681	6.37	Trip
38	220KV Fatehabad line-1	05:54:23	20.10.2023	B-ph	3.884	46.48	AR Sucessful
39	220KV Fatehabad line-1	03:04:42	27.09.2023	R-Ph	9.922	12.724	Trip
40	220KV Fatehabad line-1	03:49:50	22.09.2023	R-Ph	7.264	19.219	AR Sucessful
41	220KV Fatehabad line-1	22:12:36	16.09.2023	Y ph	4.816	30.952	AR Sucessful
42	220KV Fatehabad line-1	21:06:06	19.02.2024	B-ph	4.749	32.711	Line tripped
43	220KV Fatehabad line-1	17:25:00	10.04.2024	Y ph	3.771	50.846	Re fault in re claim time and line got tripped.
44	220KV Fatehabad line-1	12:01	12.08.2024	Y Ph	7.518	15.458	Trip
45	220KV Fatehabad line-1	20:50	08.08.2024	R PH	5.822	22.026	AR Sucessful
46	220KV Fatehabad line-1	00:41	07.08.2024	Y Ph	5.586	23.223	AR Sucessful
47	220KV Fatehabad line-1	23:22:48	06.08.2024	B-ph	5.994	23.75	AR Sucessful
48	220KV Fatehabad line-1	05:12	27.07.2024	R PH	4.645	31.251	AR Sucessful
49	220KV Fatehabad line-1	20:52:00	18.08.2024	Y Ph	4.136	33.479	AR Sucessful
50	220KV Fatehabad line-1	01:53:00	04.09.2024	R PH	8.512	13.093	AR Sucessful
51	220KV Fatehabad line-1	04:53	04.09.2024	R PH	4.382	32.435	AR Sucessful
52	220KV Fatehabad line-1	18:17	04.09.2024	R PH	6.142	20.413	AR Sucessful
53	220KV Fatehabad line-1	19:25:00	04.09.2024	Y Ph	5.61	24.364	AR Sucessful
54	220KV Fatehabad line-1	10:52	05.09.2024	R PH	6.037	20.6	Trip
55	220KV Fatehabad line-1	05:06:26	06.09.2024	B Ph	5.672	23.052	AR Sucessful
56	220KV Fatehabad line-1	21:18	14.09.2024	Y Ph	6.605	19.956	AR Sucessful
57	220KV Fatehabad line-1	02:40:12	24.09.2024	B Ph	4.723	31.011	AR Sucessful
58	220KV Fatehabad line-1	04:03:34	24.09.2024	B Ph	4.655	30.779	AR Sucessful
59	220KV Fatehabad line-1	04:03:34	24.09.2024	B Ph	4.655	30.779	AR Sucessful
60	220KV Fatehabad line-1	17:29:42	02.10.2024	B Ph	4.529	35.805	Trip
61	220KV Fatehabad line-1	18:28:58	19.10.2024	R PH	4.538	31.163	Trip
62	220KV Fatehabad line-1	17:27:49	21.10.2024	B Ph	7.567	15.614	Trip

  
**अरपित कुमार जेन / Arpit Kumar Jena**  
**प्रबन्धक / Manager**  
 पावर ग्रिड कॉर्पोरेशन ऑफ इंडिया लि., हिंसा  
 Power Grid Corporation Of India Ltd., Hinsa

**TRIPPING DETAILS OF 220KV HISAR(PG)-FATEHABAD (HVPN) LINE-2**

SI No	Name of line	Time of tripping	Date of tripping	Phase	Fault current(KA)	Fault location(KM)	Remarks
1	220 KV Fatehabad 2	03:08:02	01.08.2022	Rph	4.8	38.64	A/R sucesssful
2	220 KV Fatehabad 2	20:39	11.08.2022	Bph	5.36	32.31	A/R sucesssful
3	220 KV Fatehabad 2	18:40	22.08.2022	Rph	8.34	13.8	A/R sucesssful
4	220 KV Fatehabad 2	19:42	29.08.2022	Bph	8.96	15.08	A/R sucesssful
5	220 KV Fatehabad 2	19:25	03.09.2022	Y & Bph	2.9,2.7	63.93	Tripped
6	220 KV Fatehabad 2	21:57	04.09.2022	Rph	3.77	36.67	A/R sucesssful
7	220 KV Fatehabad 2	19:48	11.09.2022	Rph	8.41	13.14	A/R sucesssful
8	220 KV Fatehabad 2	21:45	18.09.2022	Yph	5	31.12	A/R sucesssful
9	220 KV Fatehabad 2	22:10	20.09.2022	Rph	4.8	35.92	A/R sucesssful
10	220 KV Fatehabad 2	21:52	22.09.2022	Yph	4.17	34.77	A/R sucesssful
11	220 KV Fatehabad 2	23:51	22.09.2022	Rph	4.6	35.68	A/R sucesssful
12	220 KV Fatehabad 2	01:53	23.09.2022	Rph	4.67	30.14	A/R sucesssful
13	220 KV Fatehabad 2	02:49	23.09.2022	Rph	4.77	30.04	A/R sucesssful
14	221 KV Fatehabad 2	18:59	25.09.2022	Rph	4.37	41.44	A/R sucesssful
15	222 KV Fatehabad 2	21:22	26.09.2022	Rph	5.84	26.13	A/R sucesssful
16	222 KV Fatehabad 2	05:26	30.09.2022	Yph	5.31	32.91	A/R sucesssful
17	222 KV Fatehabad 2	19:31	09.10.2022	Yph	6.3	26.31	A/R sucesssful
18	220KV Fatehabad line-2	05:52:47	07.09.2023	R-ph	9.456	13.49	A/R sucesssful
19	220KV Fatehabad line-2	23:37:10	06.09.2023	B-ph	5.668	29.744	A/R sucesssful
20	220KV Fatehabad line-2	05:32:32	04.09.2023	B-ph	4.647	38.676	A/R sucesssful
21	220KV Fatehabad line-2	21:11:26	04.08.2023	R-ph	4.533	39.227	A/R sucesssful
22	220KV Fatehabad line-2	01:30:53	03.08.2023	Y-ph	9.595	12.698	A/R sucesssful
23	220KV Fatehabad line-2	05:30:10	24.07.2023	Y-ph	4.769	37.98	A/R sucesssful
24	220KV Fatehabad line-2	16:22:57	19.07.2023	R-ph	4.183	43.177	A/R sucesssful
25	220KV Fatehabad line-2	02:09:16	29.06.2023	R-ph	4.735	38.082	A/R sucesssful
26	220KV Fatehabad line-2	23:55:42	28.06.2023	R-ph	4.683	36.589	A/R sucesssful
27	220KV Fatehabad line-2	23:05:25	19.10.2023	B-ph	12.85	8.779	AR Sucesssful
28	220KV Fatehabad line-2	02:55:37	05.10.2023	B-ph	5.568	31.759	AR Sucesssful
29	220KV Fatehabad line-2	19:51:17	04.10.2023	Y-Ph	5.476	31.132	AR Sucesssful
30	220KV Fatehabad line-2	19:14:22	04.10.2023	B-ph	5.4	31.537	AR Sucesssful
31	220KV Fatehabad line-2	19:42:25	21.09.2023	B-ph	4.689	38.896	AR Sucesssful
32	220KV Fatehabad line-2	01:26:23	19.09.2023	Y Ph	3.983	45.762	AR Sucesssful
33	220KV Fatehabad line-2	23:20:35	16.09.2023	R Ph	5.129	33.541	AR Sucesssful
34	220KV Fatehabad line-2	03:31:00	13.08.2024	R Ph	5.846	25.173	AR Sucesssful
35	220KV Fatehabad line-2	20:13	21.08.2024	B-ph	5.42	28.271	AR Sucesssful
36	220KV Fatehabad line-2	19:48	24.08.2024	R Ph	6.443	20.774	AR Sucesssful
37	220KV Fatehabad line-2	22:55:37	20.10.2024	B Ph	6.651	20.153	AR Sucesssful
38	220KV Fatehabad line-2	09:20:27	24.10.2024	R Ph	8.189	13.559	Trip
39	220KV Fatehabad line-2	02:20:15	26.10.2024	B Ph	5.273	31.684	AR Sucesssful
40	220KV Fatehabad line-2	19:34:04	30.10.2024	Y Ph	8.629	14.414	Trip
41	220KV Fatehabad line-2	01:23:36	02.11.2024	R Ph	8.254	14.553	Trip

  
 अर्पित कुमार जेन / Arpit Kumar Jena  
 प्रबंधक / Manager  
 पावर ग्रिड कॉर्पोरेशन ऑफ इंडिया लि., हिंसा  
 Power Grid Corporation Of India Ltd., Hisar





पावरग्रिड  
POWERGRID

पावर ग्रिड कॉर्पोरेशन ऑफ इंडिया लिमिटेड  
(भारत सरकार का उद्यम)  
POWER GRID CORPORATION OF INDIA LIMITED  
(A Government of India Enterprise)

400/220 KV Substation, V.P.O- Mayyar, NH-09, Distt.-Hisar (HARYANA)-125044,  
E-mail: hisarssnr1@powergrid.co.in, Mob. 8295903705,  
CIN No. L40101DL1989GOI038121

Ref:NR1/HISAR/HVPNL-FBD/2024/02

Date: 05.09.2024

To,  
Superintendent Engineer  
TS Circle, HVPNL  
Vidyut Nagar, Hisar  
Haryana-125044

Sub: Frequent A/R of 220kV Hisar (PG)- Fatehabad line-1 & 2 -reg

Ref:

1. Our regular intimation to XEN/AE-TL: Fatehabad over phone and e-mail
2. Our letter dated 03.08.2023 addressed to XEN, HVPNL Fatehabad
3. Our letter ref no. NR1/HISAR/HVPNL-FBD/ dtd. 05.09.2023 addressed to XEN, HVPNL Fatehabad.
4. Our letter ref no. NR1/HISAR/HVPNL-FBD/2024/01 Dtd. 12.08.2024 addressed to XEN, HVPNL Fatehabad

Dear Sir,

This has reference to our above letters and various recent tele discussions regarding frequent Auto reclose on the above said lines, owned by HVPNL. The frequency of auto reclose has increased in last couple of days, a total of 4 numbers Auto-reclose has been recorded in a single day, raising serious concern about healthiness of both lines for taking into service. These AR's are creating stress on our equipment's as fault feeding through our ICTs. These are also creating hotspots at various points in our 220kV Switchyard. Recent A/R and Tripping details (After last letter) are as follows:

Sl. No	Name of line	Date of tripping	Time of tripping	Phase	Fault current (KA)	Fault location (KM)	Remarks
1	220KV Fatehabad line-1	18.08.2024	20:52:00	Y Ph	4.136	33.479	AR Successful
2		04.09.2024	01:53:00	R PH	8.512	13.093	AR Successful
3			04:53	R PH	4.382	32.435	AR Successful
4			18:17	R PH	6.142	20.413	AR Successful
5			19:25:00	Y Ph	5.61	24.364	AR Successful
6		05.09.2024	10:52	R PH	6.037	20.6	Trip
7	220KV Fatehabad line-2	13.08.2024	03:31:00	R Ph	5.846	25.173	AR Successful
8		21.08.2024	20:13	B-ph	5.42	28.271	AR Successful
9		24.08.2024	19:48	R Ph	6.443	20.774	AR Successful

Also, past AR & tripping details are attached herewith this letter.

You are requested to take remedial measures to avoid such A/Rs on regular basis and inform this office. We will be required to review our A/R settings in case the problem is not addressed immediately.

Thanking you.

Yours faithfully,

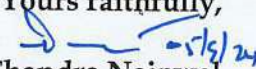
  
Dinesh Chandra Nainwal  
Sr. DGM/Hisar

दिनेश चन्द्रा नैनवाल/Dinesh Chandra Nainwal  
वरिष्ठ उप महा प्रबन्धक/Sr. D.G.M.  
Power Grid Corporation of India  
400/220, KV Sub Station  
Mayyar, Hisar-125044 (Haryana)

- Copy to
1. CGM (Cluster Head/ RHQ AM Faridabad)
  2. Chief Engineer, TS, HVPNL, Hisar
  3. Executive Engineer, HVPNL, 400kV Fatehabad



TRIPPING DETAILS OF 220KV HISAR(PG)-FATEHABAD (HVPN) LINE-1

Sl No	Name of line	Time of tripping	Date of tripping	Phase	Fault current(KA)	Fault location(KM)	Remarks
1	220KV Fatehabad 1	05:23:00	02.08.2022	Rph	3.91	38.23	A/R successful
2	220KV Fatehabad 1	04:58	03.08.222	Yph	4.006	40.68	A/R successful
3	220KV Fatehabad 1	22:21	04.08.2022	Yph	4.05	34.96	A/R successful
4	220KV Fatehabad 1	12:17	08.08.2022	Yph	4.21	33.51	A/R successful
5	220KV Fatehabad 1	04:16	15.08.2022	Rph	8.9	15.37	A/R successful
6	220KV Fatehabad 1	05:45	15.08.2022	Rph	4.32	41.64	A/R successful
7	220KV Fatehabad 1	00:39	19.08.2022	Rph	5.65	23.3	A/R successful
8	220KV Fatehabad 1	00:39	19.08.2022	Rph	4.38	31.4	A/R successful
9	220KV Fatehabad 1	18:59	27.08.2022	Rph	6.83	18.7	A/R successful
10	220KV Fatehabad 1	14:41	05.09.2022	Rph	3.72	49.21	A/R successful
11	220KV Fatehabad 1	02:42	14.09.2022	Rph	4.05	36.96	A/R successful
12	220KV Fatehabad 1	06:01	19.09.2022	Rph	4.25	34.97	A/R successful
13	220KV Fatehabad 1	09:04	21.09.2022	Bph	4.39	35.26	Tripped
14	220KV Fatehabad 1	03:53	25.09.2022	Rph	4.86	31.76	A/R successful
15	220KV Fatehabad 1	05:34	27.09.2022	Rph	4.15	38.43	A/R successful
16	220KV Fatehabad 1	21:32	27.09.2022	Yph	4.59	32.55	A/R successful
17	220KV Fatehabad 1	21:31	27.09.2022	Rph	5.16	26.31	A/R successful
18	220KV Fatehabad 1	01:29	28.09.2022	Rph	5.35	32.81	A/R successful
19	220KV Fatehabad 1	19:31	29.09.2022	Rph	3.86	41.1	A/R successful
20	220KV Fatehabad 1	02:06	09.10.2022	Rph	4.65	32.61	A/R successful
21	220KV Fatehabad 1	20:25	09.10.2022	Rph	4.26	37.13	A/R successful
22	220KV Fatehabad 1	23:17	10.10.2022	Yph	3.97	47.77	A/R successful
23	220KV Fatehabad 1	00:36	11.10.2022	Rph	5.45	26.468	A/R successful
24	220KV Fatehabad 1	03:18	12.10.2022	Rph	4.318	37.69	A/R successful
25	220KV Fatehabad 1	16:07	13.10.2022	Rph	3.83	40.94	A/R successful
26	220KV Fatehabad line-1	05:41:50	12.09.2023	B-ph	10.026	10.688	A/R successful
27	220KV Fatehabad line-1	03:02:16	03.09.2023	B-ph	4.154	37.295	A/R successful
28	220KV Fatehabad line-1	13:39:13	09.08.2023	R-ph	5.086	29.214	A/R successful
29	220KV Fatehabad line-1	23:26:04	02.08.2023	B-ph	3.3	51.94	A/R successful
30	220KV Fatehabad line-1	20:36:57	30.07.2023	Y-ph	4.258	37.01	A/R successful
31	220KV Fatehabad line-1	04:36:09	30.07.2023	R-ph	4.405	34.864	A/R successful
32	220KV Fatehabad line-1	03:25:27	30.07.2023	R-ph	8.937	13.487	A/R successful
33	220KV Fatehabad line-1	01:24:13	26.07.2023	Y-ph	4.955	30.892	A/R successful
34	220KV Fatehabad line-1	00:01:28	26.07.2023	R-ph	4.766	32.682	A/R successful
35	220KV Fatehabad line-1	04:13:33	24.05.2023	B-ph	4.939	30.673	A/R successful
36	220KV Fatehabad line-1	12:34:45	07.12.2023	R-ph	3.38	50.973	AR Successful
37	220KV Fatehabad line-1	04:18:31	26.10.2023	B Ph	15.681	6.37	Trip
38	220KV Fatehabad line-1	05:54:23	20.10.2023	B-ph	3.884	46.48	AR Successful
39	220KV Fatehabad line-1	03:04:42	27.09.2023	R-Ph	9.922	12.724	Trip
40	220KV Fatehabad line-1	03:49:50	22.09.2023	R-Ph	7.264	19.219	AR Successful
41	220KV Fatehabad line-1	22:12:36	16.09.2023	Y ph	4.816	30.952	AR Successful
42	220KV Fatehabad line-1	21:06:06	19.02.2024	B-ph	4.749	32.711	Line tripped
43	220KV Fatehabad line-1	17:25:00	10.04.2024	Y ph	3.771	50.846	Re fault in re claim time and line got tripped.
44	220KV Fatehabad line-1	12:01	12.08.2024	Y Ph	7.518	15.458	Trip
45	220KV Fatehabad line-1	20:50	08.08.2024	R PH	5.822	22.026	AR Successful
46	220KV Fatehabad line-1	00:41	07.08.2024	Y Ph	5.586	23.223	AR Successful
47	220KV Fatehabad line-1	23:22:48	06.08.2024	B-ph	5.994	23.75	AR Successful
48	220KV Fatehabad line-1	05:12	27.07.2024	R PH	4.645	31.251	AR Successful
49	220KV Fatehabad line-1	20:52:00	18.08.2024	Y Ph	4.136	33.479	AR Successful
50	220KV Fatehabad line-1	01:53:00	04.09.2024	R PH	8.512	13.093	AR Successful
51	220KV Fatehabad line-1	04:53	04.09.2024	R PH	4.382	32.435	AR Successful
52	220KV Fatehabad line-1	18:17	04.09.2024	R PH	6.142	20.413	AR Successful
53	220KV Fatehabad line-1	19:25:00	04.09.2024	Y Ph	5.61	24.364	AR Successful
54	220KV Fatehabad line-1	10:52	05.09.2024	R PH	6.037	20.6	Trip

  
 Dinesh C Nair  
 Sr DGM



TRIPPING DETAILS OF 220KV HISAR(PG)-FATEHABAD (HVPN) LINE-2

Sl No	Name of line	Time of tripping	Date of tripping	Phase	Fault current(KA)	Fault location(KM)	Remarks
1	220 KV Fatehabad 2	03:08:02	01.08.2022	Rph	4.8	38.64	A/R sucesssful
2	220 KV Fatehabad 2	20:39	11.08.2022	Bph	5.36	32.31	A/R sucesssful
3	220 KV Fatehabad 2	18:40	22.08.2022	Rph	8.34	13.8	A/R sucesssful
4	220 KV Fatehabad 2	19:42	29.08.2022	Bph	8.96	15.08	A/R sucesssful
5	220 KV Fatehabad 2	19:25	03.09.2022	Y & Bph	2.9,2.7	63.93	Tripped
6	220 KV Fatehabad 2	21:57	04.09.2022	Rph	3.77	36.67	A/R sucesssful
7	220 KV Fatehabad 2	19:48	11.09.2022	Rph	8.41	13.14	A/R sucesssful
8	220 KV Fatehabad 2	21:45	18.09.2022	Yph	5	31.12	A/R sucesssful
9	220 KV Fatehabad 2	22:10	20.09.2022	Rph	4.8	35.92	A/R sucesssful
10	220 KV Fatehabad 2	21:52	22.09.2022	Yph	4.17	34.77	A/R sucesssful
11	220 KV Fatehabad 2	23:51	22.09.2022	Rph	4.6	35.68	A/R sucesssful
12	220 KV Fatehabad 2	01:53	23.09.2022	Rph	4.67	30.14	A/R sucesssful
13	220 KV Fatehabad 2	02:49	23.09.2022	Rph	4.77	30.04	A/R sucesssful
14	221 KV Fatehabad 2	18:59	25.09.2022	Rph	4.37	41.44	A/R sucesssful
15	222 KV Fatehabad 2	21:22	26.09.2022	Rph	5.84	26.13	A/R sucesssful
16	222 KV Fatehabad 2	05:26	30.09.2022	Yph	5.31	32.91	A/R sucesssful
17	222 KV Fatehabad 2	19:31	09.10.2022	Yph	6.3	26.31	A/R sucesssful
18	220KV Fatehabad line-2	05:52:47	07.09.2023	R-ph	9.456	13.49	A/R sucesssful
19	220KV Fatehabad line-2	23:37:10	06.09.2023	B-ph	5.668	29.744	A/R sucesssful
20	220KV Fatehabad line-2	05:32:32	04.09.2023	B-ph	4.647	38.676	A/R sucesssful
21	220KV Fatehabad line-2	21:11:26	04.08.2023	R-ph	4.533	39.227	A/R sucesssful
22	220KV Fatehabad line-2	01:30:53	03.08.2023	Y-ph	9.595	12.698	A/R sucesssful
23	220KV Fatehabad line-2	05:30:10	24.07.2023	Y-ph	4.769	37.98	A/R sucesssful
24	220KV Fatehabad line-2	16:22:57	19.07.2023	R-ph	4.183	43.177	A/R sucesssful
25	220KV Fatehabad line-2	02:09:16	29.06.2023	R-ph	4.735	38.082	A/R sucesssful
26	220KV Fatehabad line-2	23:55:42	28.06.2023	R-ph	4.683	36.589	A/R sucesssful
27	220KV Fatehabad line-2	23:05:25	19.10.2023	B-ph	12.85	8.779	AR Sucesssful
28	220KV Fatehabad line-2	02:55:37	05.10.2023	B-ph	5.568	31.759	AR Sucesssful
29	220KV Fatehabad line-2	19:51:17	04.10.2023	Y-Ph	5.476	31.132	AR Sucesssful
30	220KV Fatehabad line-2	19:14:22	04.10.2023	B-ph	5.4	31.537	AR Sucesssful
31	220KV Fatehabad line-2	19:42:25	21.09.2023	B-ph	4.689	38.896	AR Sucesssful
32	220KV Fatehabad line-2	01:26:23	19.09.2023	Y Ph	3.983	45.762	AR Sucesssful
33	220KV Fatehabad line-2	23:20:35	16.09.2023	R Ph	5.129	33.541	AR Sucesssful
34	220KV Fatehabad line-2	03:31:00	13.08.2024	R Ph	5.846	25.173	AR Sucesssful
35	220KV Fatehabad line-2	20:13	21.08.2024	B-ph	5.42	28.271	AR Sucesssful
36	220KV Fatehabad line-2	19:48	24.08.2024	R Ph	6.443	20.774	AR Sucesssful

*Drinal C. Arizma*





**पावरग्रिड**  
**POWERGRID**

पावर ग्रिड कॉर्पोरेशन ऑफ इंडिया लिमिटेड  
(भारत सरकार का उद्यम)  
**POWER GRID CORPORATION OF INDIA LIMITED**  
(A Government of India Enterprise)

400/220 KV Substation, V.P.O- Mayyar, NH-09, Distt.-Hisar (HARYANA)-125044,  
E-mail: hisarssur1@powergrid.co.in, Mob. 8295903705,  
CIN No. L40101DL1989GOI038121

Ref:NR1/HISAR/HVPNL-FBD/2024/01

Date: 12.08.2024

To,  
XEN, HVPNL  
Vidyut Nagar  
HVPNL, Hiar.

Sub: Frequent A/R of 220kV Hisar (PG)- Fatehabad line-1 & 2 -reg

- Ref: 1.our regular intimation to AE/TL/Fatehabad over phone and e-mail  
2. Our letter dated 03.08.2023 addressed to you(Copy attached)  
3.Our letter ref no. NR1/HISAR/HVPNL-FBD/ dtd. 05.09.2023 addressed to you (Copy attached).

Dear Sir,

This has reference to our letter dated 23.10.2023 and various recent tele discussions regarding frequent Auto reclose on the above said lines, owned by HVPNL. The frequency of auto reclose has increased in last days, a total of 4-5 numbers Auto-reclose & Tripping has been recorded in last one month. These AR & Tripping's are creating stress on our equipment's as fault feeding through our ICTs. These are also creating hotspots at various points in our 220kV Switchyard. Recent A/R and Tripping details are as follows:

Sl. No	Name of line	Time of tripping	Date of tripping	Phase	Fault current (KA)	Fault location (KM)	Remarks
1	220KV Fatehabad line-1	12:01	12.08.2024	Y Ph	7.518	15.458	Trip
2		20:50	08.08.2024	R PH	5.822	22.026	AR Successful
3		00:41	07.08.2024	Y Ph	5.586	23.223	AR Successful
4		23:22:48	06.08.2024	B-ph	5.994	23.75	AR Successful
5		05:12	27.07.2024	R PH	4.645	31.251	AR Successful

Also, Last 02-years AR & tripping details are attached herewith this letter.

You are requested to take remedial measures to avoid such A/Rs on regular basis and inform this office. We will be required to review our A/R settings in case the problem is not addressed immediately.

Thanking you.

Yours faithfully,

  
Dinesh Chandra Nainwal  
Sr. DGM/Hisar  
POWERGRID

दिनेश चन्द्रा नैनवाल/Dinesh Chandra Nainwal  
वरिष्ठ उप महा प्रबन्धक/Sr. D.G.M.  
Power Grid Corporation of India  
400/220. KV Sub Station  
Mayyar, Hisar-125044 (Haryana)



TRIPPING DETAILS OF 220KV HISAR(PG)-FATEHABAD (HVPN) LINE-1

Sl No	Name of line	Time of tripping	Date of tripping	Phase	Fault current(KA)	Fault location(KM)	Remarks
1	220KV Fatehabad 1	05:23:00	02.08.2022	Rph	3.91	38.23	A/R successful
2	220KV Fatehabad 1	04:58	03.08.2022	Yph	4.006	40.68	A/R successful
3	220KV Fatehabad 1	22:21	04.08.2022	Yph	4.05	34.96	A/R successful
4	220KV Fatehabad 1	12:17	08.08.2022	Yph	4.21	33.51	A/R successful
5	220KV Fatehabad 1	04:16	15.08.2022	Rph	8.9	15.37	A/R successful
6	220KV Fatehabad 1	05:45	15.08.2022	Rph	4.32	41.64	A/R successful
7	220KV Fatehabad 1	00:39	19.08.2022	Rph	5.65	23.3	A/R successful
8	220KV Fatehabad 1	00:39	19.08.2022	Rph	4.38	31.4	A/R successful
9	220KV Fatehabad 1	18:59	27.08.2022	Rph	6.83	18.7	A/R successful
10	220KV Fatehabad 1	14:41	05.09.2022	Rph	3.72	49.21	A/R successful
11	220KV Fatehabad 1	02:42	14.09.2022	Rph	4.05	36.96	A/R successful
12	220KV Fatehabad 1	06:01	19.09.2022	Rph	4.25	34.97	A/R successful
13	220KV Fatehabad 1	09:04	21.09.2022	Bph	4.39	35.26	Tripped
14	220KV Fatehabad 1	03:53	25.09.2022	Rph	4.86	31.76	A/R successful
15	220KV Fatehabad 1	05:34	27.09.2022	Rph	4.15	38.43	A/R successful
16	220KV Fatehabad 1	21:32	27.09.2022	Yph	4.59	32.55	A/R successful
17	220KV Fatehabad 1	21:31	27.09.2022	Rph	5.16	26.31	A/R successful
18	220KV Fatehabad 1	01:29	28.09.2022	Rph	5.35	32.81	A/R successful
19	220KV Fatehabad 1	19:31	29.09.2022	Rph	3.86	41.1	A/R successful
20	220KV Fatehabad 1	02:06	09.10.2022	Rph	4.65	32.61	A/R successful
21	220KV Fatehabad 1	20:25	09.10.2022	Rph	4.26	37.13	A/R successful
22	220KV Fatehabad 1	23:17	10.10.2022	Yph	3.97	47.77	A/R successful
23	220KV Fatehabad 1	00:36	11.10.2022	Rph	5.45	26.468	A/R successful
24	220KV Fatehabad 1	03:18	12.10.2022	Rph	4.318	37.69	A/R successful
25	220KV Fatehabad 1	16:07	13.10.2022	Rph	3.83	40.94	A/R successful
26	220KV Fatehabad line-1	05:41:50	12.09.2023	B-ph	10.026	10.688	A/R successful
27	220KV Fatehabad line-1	03:02:16	03.09.2023	B-ph	4.154	37.295	A/R successful
28	220KV Fatehabad line-1	13:39:13	09.08.2023	R-ph	5.086	29.214	A/R successful
29	220KV Fatehabad line-1	23:26:04	02.08.2023	B-ph	3.3	51.94	A/R successful
30	220KV Fatehabad line-1	20:36:57	30.07.2023	Y-ph	4.258	37.01	A/R successful
31	220KV Fatehabad line-1	04:36:09	30.07.2023	R-ph	4.405	34.864	A/R successful
32	220KV Fatehabad line-1	03:25:27	30.07.2023	R-ph	8.937	13.487	A/R successful
33	220KV Fatehabad line-1	01:24:13	26.07.2023	Y-ph	4.955	30.892	A/R successful
34	220KV Fatehabad line-1	00:01:28	26.07.2023	R-ph	4.766	32.682	A/R successful
35	220KV Fatehabad line-1	04:13:33	24.05.2023	B-ph	4.939	30.673	A/R successful
36	220KV Fatehabad line-1	12:34:45	07.12.2023	R-ph	3.38	50.973	AR Successful
37	220KV Fatehabad line-1	04:18:31	26.10.2023	B Ph	15.681	6.37	Trip
38	220KV Fatehabad line-1	05:54:23	20.10.2023	B-ph	3.884	46.48	AR Successful
39	220KV Fatehabad line-1	03:04:42	27.09.2023	R-Ph	9.922	12.724	Trip
40	220KV Fatehabad line-1	03:49:50	22.09.2023	R-Ph	7.264	19.219	AR Successful
41	220KV Fatehabad line-1	22:12:36	16.09.2023	Y ph	4.816	30.952	AR Successful
42	220KV Fatehabad line-1	21:06:06	19.02.2024	B-ph	4.749	32.711	Line tripped
43	220KV Fatehabad line-1	17:25:00	10.04.2024	Y ph	3.771	50.846	Re fault in re claim time and line got tripped.
44	220KV Fatehabad line-1	12:01	12.08.2024	Y Ph	7.518	15.458	Trip
45	220KV Fatehabad line-1	20:50	08.08.2024	R PH	5.822	22.026	AR Successful
46	220KV Fatehabad line-1	00:41	07.08.2024	Y Ph	5.586	23.223	AR Successful
47	220KV Fatehabad line-1	23:22:48	06.08.2024	B-ph	5.994	23.75	AR Successful
48	220KV Fatehabad line-1	05:12	27.07.2024	R PH	4.645	31.251	AR Successful

Verified

Arpit

अर्पित कुमार जैन/Arpit Kumar Jain  
 प्रबंधक/Manager  
 पावर ग्रिड कॉर्पोरेशन ऑफ इंडिया लि., हिंसा  
 Power Grid Corporation Of India Ltd., Hisar



TRIPPING DETAILS OF 220KV HISAR(PG)-FATEHABAD (HVPN) LINE-2

Sl No	Name of line	Time of tripping	Date of tripping	Phase	Fault current(KA)	Fault location(KM)	Remarks
1	220 KV Fatehabad 2	03:08:02	01.08.2022	Rph	4.8	38.64	A/R sucesssful
2	220 KV Fatehabad 2	20:39	11.08.2022	Bph	5.36	32.31	A/R sucesssful
3	220 KV Fatehabad 2	18:40	22.08.2022	Rph	8.34	13.8	A/R sucesssful
4	220 KV Fatehabad 2	19:42	29.08.2022	Bph	8.96	15.08	A/R sucesssful
5	220 KV Fatehabad 2	19:25	03.09.2022	Y & Bph	2.9,2.7	63.93	Tripped
6	220 KV Fatehabad 2	21:57	04.09.2022	Rph	3.77	36.67	A/R sucesssful
7	220 KV Fatehabad 2	19:48	11.09.2022	Rph	8.41	13.14	A/R sucesssful
8	220 KV Fatehabad 2	21:45	18.09.2022	Yph	5	31.12	A/R sucesssful
9	220 KV Fatehabad 2	22:10	20.09.2022	Rph	4.8	35.92	A/R sucesssful
10	220 KV Fatehabad 2	21:52	22.09.2022	Yph	4.17	34.77	A/R sucesssful
11	220 KV Fatehabad 2	23:51	22.09.2022	Rph	4.6	35.68	A/R sucesssful
12	220 KV Fatehabad 2	01:53	23.09.2022	Rph	4.67	30.14	A/R sucesssful
13	220 KV Fatehabad 2	02:49	23.09.2022	Rph	4.77	30.04	A/R sucesssful
14	221 KV Fatehabad 2	18:59	25.09.2022	Rph	4.37	41.44	A/R sucesssful
15	222 KV Fatehabad 2	21:22	26.09.2022	Rph	5.84	26.13	A/R sucesssful
16	222 KV Fatehabad 2	05:26	30.09.2022	Yph	5.31	32.91	A/R sucesssful
17	222 KV Fatehabad 2	19:31	09.10.2022	Yph	6.3	26.31	A/R sucesssful
18	220KV Fatehabad line-2	05:52:47	07.09.2023	R-ph	9.456	13.49	A/R sucesssful
19	220KV Fatehabad line-2	23:37:10	06.09.2023	B-ph	5.668	29.744	A/R sucesssful
20	220KV Fatehabad line-2	05:32:32	04.09.2023	B-ph	4.647	38.676	A/R sucesssful
21	220KV Fatehabad line-2	21:11:26	04.08.2023	R-ph	4.533	39.227	A/R sucesssful
22	220KV Fatehabad line-2	01:30:53	03.08.2023	Y-ph	9.595	12.698	A/R sucesssful
23	220KV Fatehabad line-2	05:30:10	24.07.2023	Y-ph	4.769	37.98	A/R sucesssful
24	220KV Fatehabad line-2	16:22:57	19.07.2023	R-ph	4.183	43.177	A/R sucesssful
25	220KV Fatehabad line-2	02:09:16	29.06.2023	R-ph	4.735	38.082	A/R sucesssful
26	220KV Fatehabad line-2	23:55:42	28.06.2023	R-ph	4.683	36.589	A/R sucesssful
27	220KV Fatehabad line-2	23:05:25	19.10.2023	B-ph	12.85	8.779	AR Successful
28	220KV Fatehabad line-2	02:55:37	05.10.2023	B-ph	5.568	31.759	AR Successful
29	220KV Fatehabad line-2	19:51:17	04.10.2023	Y-Ph	5.476	31.132	AR Successful
30	220KV Fatehabad line-2	19:14:22	04.10.2023	B-ph	5.4	31.537	AR Successful
31	220KV Fatehabad line-2	19:42:25	21.09.2023	B-ph	4.689	38.896	AR Successful
32	220KV Fatehabad line-2	01:26:23	19.09.2023	Y Ph	3.983	45.762	AR Successful
33	220KV Fatehabad line-2	23:20:35	16.09.2023	R Ph	5.129	33.541	AR Successful

Vatant

*(Signature)*

आरपी कुमार जैन/Arpit Kumar Jain  
 प्रबंधक/Manager  
 पावर ग्रिड कॉर्पोरेशन ऑफ इंडिया लि., हिसार  
 Power Grid Corporation Of India Ltd., Hisar





**पावरग्रिड  
POWERGRID**

पावर ग्रिड कॉर्पोरेशन ऑफ इंडिया लिमिटेड  
(भारत सरकार का उद्यम)

**POWER GRID CORPORATION OF INDIA LIMITED**  
(A Government of India Enterprise)

400/220 KV Substation, V.P.O- Mayyar, NH-09, Distt.-Hisar (HARYANA)-125044.  
E-mail: hisarssnr1@powergrid.co.in, Mob. 8295903705.  
CIN No. L40101DL1989GOI038121

Ref:NR1/HISAR/HVPNL-FBD/

Date: 05.09.2023.

To:  
XEN, HVPNL  
Vidyut Nagar  
HVPNL, Hiar.

Sub: Frequent A/R of 220kV Hisar(PG)- Fatehabad line-1 & 2 -reg

Ref: 1.our regular intimation to AE/TL/Fatehabad over phone and e-mail  
2. Our letter dated 14.10.2022 & 03.08.2023 addressed to you.

Dear Sir,

In continuation of our earlier communication, it is once again requested to find out the root cause of frequent auto-reclosures in the 200kV Fatehabad-1 and 2. In the stating week of September 23, two numbers auto reclosure has occurred.

From the beginning of this Financial year total 16(Sixteen) numbers of auto-reclosed has been noticed. Frequent Auto reclosure causing hot-spot in our 220kV Yard and we are continuously changing terminal connectors on account of this. Besides un-necessary stress on transformer, Circuit Breakers and other equipments  
You are once again requested to take necessary measure to control the auto-reclosure.

Thanking you,

Yours faithfully,

**Dinesh Chandra Nainwal**  
**Sr.DGM/Hisar**

दिनेश चंद्र नैनवाल  
Dinesh Chandra Nainwal  
Sr. Dy. General Manager  
Powergrid Corporation of India Ltd.  
400/220 KV S/S  
Delhi-Hisar NH-9, V.P.O. Mayar  
Hisar (HR) - 125044



**पावरग्रिड**  
**POWERGRID**

पावर ग्रिड कॉर्पोरेशन ऑफ इंडिया लिमिटेड  
(भारत सरकार का उद्यम)

**POWER GRID CORPORATION OF INDIA LIMITED**  
(A Government of India Enterprise)

400/220 KV Substation, V.P.O- Mayyar, NH-09, Distt.-Hisar (HARYANA)-125044.  
E-mail: hisarssnr1@powergrid.co.in, Mob. 8295903705.  
CIN No. L40101DL1989GOI038121

Ref:NR1/HISAR/HVPNL-FBD/

Date: 03.08.2023.

To,  
XEN, HVPNL  
Vidyut Nagar  
HVPNL, Hiar.

Sub: Frequent A/R of 220kV Hisar (PG)- Fatehabad line-1 & 2 -reg

Ref: 1.our regular intimation to AE/TL/Fatehabad over phone and e-mail  
2. Our letter dated 14.10.2022 addressed to you.

Dear Sir,

This has reference to our letter dated 14.10.2022 and meeting held in your office in regard to frequent Auto reclose on the above said lines, owned by HVPNL. The frequency of auto reclose has increased in last 2 months, a total of 11 numbers Auto-reclose has been recorded. The above Auto-reclose are creating stress on our equipments as fault feeding through our ICTs. This is also creating hotspots at various points in our 220kV Switchyard.

You are requested to take remedial measures to avoid such A/Rs on regular basis and inform this office. We will required to review our A/R settings in case the problem is not attended.

Thanking you,

Yours faithfully,

**Dinesh Chandra Nainwal**  
दिनेश चंद्र नैशवाल  
Sr. Dy. General Manager  
Powergrid Corporation of India Ltd.  
400/220 KV S/S  
Delhi-Hisar NH-9, V.P.O. Mayar  
Hisar (HR) - 125044

Encl:- List of A/R

**TRIPPING DETAILS OF 220KV HISAR(PG)-FATEHABAD (HVPN) LINE-1 WEF 01.04.2023**

Sl No	Name of line	Time of tripping	Date of tripping	Phase	Fault current(K)	Fault location(KM)	Remarks
1	220KV Fatehabad line-1	23:26:04	02.08.2023	B-ph	3.3	51.94	
2	220KV Fatehabad line-1	20:36:57	30.07.2023	Y-ph	4.258	37.01	
3	220KV Fatehabad line-1	4:36:09	30.07.2023	R-ph	4.405	34.864	
4	220KV Fatehabad line-1	3:25:27	30.07.2023	R-ph	8.937	13.487	
5	220KV Fatehabad line-1	1:24:13	26.07.2023	Y-ph	4.955	30.892	
6	220KV Fatehabad line-1	0:01:28	26.07.2023	R-ph	4.766	32.682	
7	220KV Fatehabad line-1	4:13:33	24.05.2023	B-ph	4.939	30.673	

शिवप्रसाद  
03/08/2023

जी शिव प्रसाद/G Siva Parsad  
उप प्रबंधक/Deputy Manager  
Power Grid Corporation of India Ltd.  
400/220 KV Sub Station  
Mayyar Hisar Haryana-125044

TRIPPING DETAILS OF 220KV HISAR(PG)-FATEHABAD (HVPN) LINE-2 W.E.F 01.04.2023

Sl No	Name of line	Time of tripping	Date of tripping	Phase	Fault current(K A)	Fault location(KM)	Remarks
1	220KV Fatehabad line-2	1:30:53	03.08.2023	Y-ph	9.595	12.698	
2	220KV Fatehabad line-2	5:30:10	24.07.2023	Y-ph	4.769	37.98	
3	220KV Fatehabad line-2	16:22:57	19.07.2023	R-ph	4.183	43.177	
4	220KV Fatehabad line-2	2:09:16	29.06.2023	R-ph	4.735	38.082	
5	220KV Fatehabad line-2	23:55:42	28.06.2023	R-ph	4.683	36.589	

बिष्णु 03/08/23

जी शिव प्रसाद/G Siva Parsad  
उप प्रबंधक/Deputy Manager  
Power Grid Corporation of India Ltd.  
400/220 KV Sub Station  
Mayyar Hisar Haryana-125044





**पावरग्रिड  
POWERGRID**

**पावर ग्रिड कॉर्पोरेशन ऑफ इंडिया लिमिटेड**  
(भारत सरकार का उद्यम)

**POWER GRID CORPORATION OF INDIA LIMITED**  
(A Government of India Enterprise)

400/220 KV Substation, V.P.O- Mayyar, NH-09, Distt.-Hisar (HARYANA)-125044,  
E-mail: hisarssur1@powergrid.co.in, Mob. 8295903705,  
CIN No. L40101DL1989GOI038121

Ref:NR1/HISAR/HVPNL-FBD/

Date: 14.10.2022.

To:  
XEN, HVPNL  
Vidyut Nagar  
HVPNL, Hiar.

Sub: Frequent A/R of 220kV Hisar(PG)- Fatehabad line-1 & 2 -reg

Ref: our regular intimation to AE/TL/Fatehabad over phone and e-mail- reg

Dear Sir,

220kV Hisar(PG)-Fatehabad ckt-1 and ckt-2 lines are getting A/R on regular basis. In the last two months, there are 42 A/R operations on the both the lines, which is creating stress on the equipment and fault feeding through our ICTs.

You are requested to take remedial measures to avoid such A/Rs on regular basis.

Thanking you,

Yours faithfully,

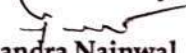
  
Dinesh Chandra Nainwal  
DGM/Hisar

*Received*  
*SJ*  
*14/10/22*

*Mr. Sunil Kumar*

TRIPPING DETAILS OF 220KV HISAR(PG)-FATEHABAD LINE-1

Sr no.	Name of line	Time of Triping	Date of triping	Phase	Fault current(KA)	Fault location(KM)	Remarks
1	220KV Fatehabad 1	5:23:00	02.08.2022	Rph	3.91	38.23	A/R successful
2	220KV Fatehabad 1	4:58	03.08.2022	Yph	4.006	40.68	A/R successful
3	220KV Fatehabad 1	22:21	04.08.2022	Yph	4.05	34.96	A/R successful
4	220KV Fatehabad 1	12:17	08.08.2022	Yph	4.21	33.51	A/R successful
5	220KV Fatehabad 1	4:16	15.08.2022	Rph	8.9	15.37	A/R successful
6	220KV Fatehabad 1	5:45	15.08.2022	Rph	4.32	41.64	A/R successful
7	220KV Fatehabad 1	0:39	19.08.2022	Rph	5.65	23.3	A/R successful
8	220KV Fatehabad 1	0:39	19.08.2022	Rph	4.38	31.4	A/R successful
9	220KV Fatehabad 1	18:59	27.08.2022	Rph	6.83	18.7	A/R successful
10	220KV Fatehabad 1	14:41	05.09.2022	Rph	3.72	49.21	A/R successful
11	220KV Fatehabad 1	2:42	14.09.2022	Rph	4.05	36.96	A/R successful
12	220KV Fatehabad 1	6:01	19.09.2022	Rph	4.25	34.97	A/R successful
13	220KV Fatehabad 1	9:04	21.09.2022	Bph	4.39	35.26	Tripped
14	220KV Fatehabad 1	3:53	25.09.2022	Rph	4.86	31.76	A/R successful
15	220KV Fatehabad 1	5:34	27.09.2022	Rph	4.15	38.43	A/R successful
16	220KV Fatehabad 1	21:32	27.09.2022	Yph	4.59	32.55	A/R successful
17	220KV Fatehabad 1	21:31	27.09.2022	Rph	5.16	26.31	A/R successful
18	220KV Fatehabad 1	1:29	28.09.2022	Rph	5.35	32.81	A/R successful
19	220KV Fatehabad 1	19:31	29.09.2022	Rph	3.86	41.1	A/R successful
20	220KV Fatehabad 1	2:06	09.10.2022	Rph	4.65	32.61	A/R successful
21	220KV Fatehabad 1	20:25	09.10.2022	Rph	4.26	37.13	A/R successful
22	220KV Fatehabad 1	23:17	10.10.2022	Yph	3.97	47.77	A/R successful
23	220KV Fatehabad 1	0:36	11.10.2022	Rph	5.45	26.468	A/R successful
24	220KV Fatehabad 1	3:18	12.10.2022	Rph	4.318	37.69	A/R successful
25	220KV Fatehabad 1	16:07	13.10.2022	Rph	3.83	40.94	A/R successful

शिव प्रसाद

G. SIVA PRAASAD

Dy Manager

जी शिव प्रसाद/G Siva Parsad  
उप प्रबंधक/Deputy Manager  
Power Grid Corporation of India Ltd.  
400/220 KV Sub Station  
Mayyar Hisar Haryana-125044

TRIPPING DETAILS OF 220KV HISAR(PG)-FATEHABAD LINE-2

Sr no.	Name of Line	Time of Triping	Date of triping	Phase	Fault current(KA)	Fault location(KM)	Remarks
1	220 KV Fatehabad 2	3:08:02	01.08.2022	Rph	4.8	38.64	A/R sucesssful
2	220 KV Fatehabad 2	20:39	11.08.2022	Bph	5.36	32.31	A/R sucesssful
3	220 KV Fatehabad 2	18:40	22.08.2022	Rph	8.34	13.8	A/R sucesssful
4	220 KV Fatehabad 2	19:42	29.08.2022	Bph	8.96	15.08	A/R sucesssful
5	220 KV Fatehabad 2	19:25	03.09.2022	Y & Bph	2.9,2.7	63.93	Tripped
6	220 KV Fatehabad 2	21:57	04.09.2022	Rph	3.77	36.67	A/R sucesssful
7	220 KV Fatehabad 2	19:48	11.09.2022	Rph	8.41	13.14	A/R sucesssful
8	220 KV Fatehabad 2	21:45	18.09.2022	Yph	5	31.12	A/R sucesssful
9	220 KV Fatehabad 2	22:10	20.09.2022	Rph	4.8	35.92	A/R sucesssful
10	220 KV Fatehabad 2	21:52	22.09.2022	Yph	4.17	34.77	A/R sucesssful
11	220 KV Fatehabad 2	23:51	22.09.2022	Rph	4.6	35.68	A/R sucesssful
12	220 KV Fatehabad 2	1:53	23.09.2022	Rph	4.67	30.14	A/R sucesssful
13	220 KV Fatehabad 2	2:49	23.09.2022	Rph	4.77	30.04	A/R sucesssful
14	221 KV Fatehabad 2	18:59	25.09.2022	Rph	4.37	41.44	A/R sucesssful
15	222 KV Fatehabad 2	21:22	26.09.2022	Rph	5.84	26.13	A/R sucesssful
16	222 KV Fatehabad 2	5:26	30.09.2022	Yph	5.31	32.91	A/R sucesssful
17	222 KV Fatehabad 2	19:31	09.10.2022	Yph	6.3	26.31	A/R sucesssful

शिव प्रसाद

G. SIVA PRAJAD

Dy Manager

जी शिव प्रसाद/G Siva Parsad

उप प्रबंधक/Deputy Manager

Power Grid Corporation of India Ltd.

400/220 KV Sub Station

Mayyar Hisar Haryana-125044





## Frequent Faults on the 220kV Hisar-Fatehabad Lines

**From** Pankaj Kumar Jha {पंकज कुमार झा} <pankaj.jha@powergrid.in>

**Date** Mon 2024-12-02 16:53

**To** setshsr@hvpn.org.in <setshsr@hvpn.org.in>; cetshsr@hvpn.org.in <cetshsr@hvpn.org.in>; xentshsr@hvpn.org.in <xentshsr@hvpn.org.in>; xenomhsr@bbmb.nic.in <xenomhsr@bbmb.nic.in>; ddpntbwn1@gmail.com <ddpntbwn1@gmail.com>; xenomhsr@bbmb.nic.in <xenomhsr@bbmb.nic.in>; seombwn@bbmb.nic.in <seombwn@bbmb.nic.in>

**Cc** dharmendra.cea@gov.in <dharmendra.cea@gov.in>; pandeyr.cea@gov.in <pandeyr.cea@gov.in>; ms-nrpc@nic.in <ms-nrpc@nic.in>; seo-nrpc@nic.in <seo-nrpc@nic.in>; lokesh.cea@gov.in <lokesh.cea@gov.in>; deepak.kr@grid-india.in <deepak.kr@grid-india.in>; nrldcso2@grid-india.in <nrldcso2@grid-india.in>; somara.lakra@grid-india.in <somara.lakra@grid-india.in>; rtamc.nr1 <rtamc.nr1@powergrid.in>; Vishal Roy {विशाल रॉय} <vishal.roy@powergrid.in>; Kuleshwar Sahu {कुलेश्वर साहू} <kuleshwar@powergrid.in>; Neeraj Kumar {नीरज कुमार} <Neerajk@powergrid.in>; Ankit Bhargava {अंकित भार्गव} <ram.ankit05@powergrid.in>; Kritika Chopra {कृतिका चोपड़ा} <kritika.chopra@powergrid.in>; M Thirumala Reddy {एम. तिरूमाला रेड्डी} <thirumalareddy@powergrid.in>; Ravindra Nath Gupta {आर.एन. गुप्ता} <ravindrangupta@powergrid.in>; ccprotection <ccprotection@powergrid.in>; Ravi Wadyalkar {रवि अशोक वाड्यालकर} <wravi@powergrid.in>; Ankit Vaish {अंकित वैश्य} <ankit\_vaish@powergrid.in>; Dinesh Chandra Nainwal {दिनेश चन्द्र नैनवाल} <nainwal@powergrid.in>

3 attachments (12 MB)

Letter\_HVPLN\_02.12.2024\_Frequent Tripping.pdf; E-mail\_Grid India\_05.09.2024.pdf; Copy of letters to HVPLN from Hisar Substation.pdf;

Dear Sir,

Please find attached a letter regarding the frequent faults on the 220kV Hisar-Fatehabad lines. This refers to multiple communications concerning the recurring auto-reclosing and tripping incidents on the 220kV Hisar-Fatehabad lines, with over 60 faults on Line-1 and 45 on Line-2 in the past two years.

These frequent faults have caused significant damage to conductors and switching equipment in the 220kV switchyard at the Hisar Substation. Despite our previous requests, the issue remains unresolved. We kindly request that a thorough investigation be conducted and immediate corrective action be taken.

**If this issue is not addressed soon, POWERGRID may need to review its AR settings.**

We look forward to your prompt response.

Warm Regards

Pankaj Kumar Jha

Chief Manager (Asset Management)

Power Grid Corporation of India Limited

Regional Headquarters, Northern Region-1

SCO Bay No.5 -10, Sector-16A, Faridabad, Haryana-121002

Mob: +919634440125





Ref: NR-1/AM/DTL/Tripping

Dt. 04.12.2024

To,  
DGM (O&M)  
Delhi Transco Limited (DTL)  
220 kV Substation,  
Park Street Delhi

**Subject: Protection System Failure at Gopalpur (DTL) Substation Impacting Mandola (PG) Substation**

Dear Sir,

As per the MoU between POWERGRID and DTL, POWERGRID Mandola is maintaining 4 nos. 400 kV bays and 18 nos. 220 kV bays, including 8 nos. 220 kV lines pertaining to DTL, on mutually agreed terms.

We wish to bring to your kind attention that, Mandola-Gopalpur lines are experiencing faults that are often cleared in Zone 2/Zone 3 from the Mandola end due to the failure of the protection system at the Gopalpur Substation. These delayed fault clearances are causing stress on the ICTs at Mandola Substation, as these faults are being fed by the ICTs installed at Mandola. As you are aware, most of the switchgear in the 220 kV bays has aged, and such frequent and prolonged fault feeding increases the risk of switchgear failure.

It is also noted that, as a stop-gap arrangement, DTL has implemented IDMT O/C & E/F protection for the Mandola-Gopalpur Line-1 and Line-2. However, this protection will only trip after a time delay in cases where faults are not cleared from the Gopalpur end. In light of the above, we request you to urgently address the issue and ensure that the protection system at Gopalpur Substation is made fully operational. Otherwise, **POWERGRID will be compelled to revise its Zone-2 and Zone-3 settings to operate instantaneously, instead of with a time delay, to prevent further stress on the system.**

Your immediate action in this matter will be greatly appreciated.

Thanking you.

  
**Kuleshwar Sahu**  
CGM-AM, NR1 Gr-1

**Encl:** 1. Analysis of delayed fault clearance.

**Copy to:** 1. Member Secretary, NRPC (E-mail: ms-nrpc@nic.in)  
2. SEO, NRPC (E-mail: seo-nrpc@nic.in)  
3. NRLDC SO2 (E-mail: nrldcso2@grid-india.in)



## Urgent: Protection System Issue at Gopalpur Substation

**From** Pankaj Kumar Jha {पंकज कुमार झा} <pankaj.jha@powergrid.in>

**Date** Wed 2024-12-04 14:03

**To** dgm.north.dtl@gmail.com <dgm.north.dtl@gmail.com>

**Cc** dharmendra.cea@gov.in <dharmendra.cea@gov.in>; pandeyr.cea@gov.in <pandeyr.cea@gov.in>; ms-nrpc@nic.in <ms-nrpc@nic.in>; seo-nrpc@nic.in <seo-nrpc@nic.in>; lokesh.cea@gov.in <lokesh.cea@gov.in>; deepak.kr@grid-india.in <deepak.kr@grid-india.in>; nrlcso2@grid-india.in <nrlcso2@grid-india.in>; somara.lakra@grid-india.in <somara.lakra@grid-india.in>; rtamc.nr1 <rtamc.nr1@powergrid.in>; Vishal Roy {विशाल रॉय} <vishal.roy@powergrid.in>; Kuleshwar Sahu {कुलेश्वर साहू} <kuleshwar@powergrid.in>; Neeraj Kumar {नीरज कुमार} <Neerajk@powergrid.in>; Ankit Bhargava {अंकित भार्गव} <ram.ankit05@powergrid.in>; Kritika Chopra {कृतिका चोपड़ा} <kritika.chopra@powergrid.in>; M Thirumala Reddy {एम. तिरूमाला रेड्डी} <thirumalareddy@powergrid.in>; Ravindra Nath Gupta {आर.एन. गुप्ता} <ravindrangupta@powergrid.in>; ccprotection <ccprotection@powergrid.in>; Ravi Wadyalkar {रवि अशोक वाड्यालकर} <wravi@powergrid.in>; Ankit Vaish {अंकित वैश्य} <ankit\_vaish@powergrid.in>; Dr. Vinit Kr Singh {विनीत कुमार सिंह} <vineet@powergrid.in>

4 attachments (6 MB)

Re: Enabling Overcurrent & Earth Fault settings in 220 kV Mandola-Gopalpur Ckt.-1 & 2 at Mandola end; Gopalpur Line Tripping Incident-2.pdf; Gopalpur Line Tripping Incident-1.pdf; Letter\_DTL\_Gopalpur Lines.pdf;

Dear Sir,

Please find attached the letter regarding the frequent faults on the Mandola-Gopalpur lines, which are not being cleared promptly due to issues with the protection system at Gopalpur Substation. This delay is causing stress on the ICTs at Mandola and increasing the risk of switchgear failure.

We kindly request urgent action to make the protection system at Gopalpur fully operational. If this issue is not addressed, we may need to revise the Zone-2 and Zone-3 settings to prevent further stress on the system.

Your immediate attention to this matter is greatly appreciated.

Warm Regards

Pankaj Kumar Jha

Chief Manager (Asset Management)

Power Grid Corporation of India Limited

Regional Headquarters, Northern Region-1

SCO Bay No.5 -10, Sector-16A, Faridabad, Haryana-121002

Mob: +919634440125



---

**Re: Enabling Overcurrent & Earth Fault settings in 220 kV Mandola-Gopalpur Ckt.-1 & 2 at Mandola end**

---

**From** Ramjash Bhakal {रामजस भाकल} <bhakalramjash@powergrid.in>

**Date** Wed 2024-11-06 18:47

**To** Shankar Kumar Jha <jhashankarjha@gmail.com>

**Cc** vinod35292 <vinod35292@gmail.com>; Pankaj Kumar Jha {पंकज कुमार झा} <pankaj.jha@powergrid.in>; Neeraj Kumar {नीरज कुमार} <Neerajk@powergrid.in>

1 attachment (279 KB)

GOPALPUR SETTINGS.rar;

Dear sir,

Please find attached revised settings in Gopalpur ckt 1& 2 as per trailing mail.

**Ramjash Bhakal**  
**Deputy Manager**  
**Powergrid Corporation of India Ltd .**  
**400/220 KV Mandola Sub-Station NR-1**  
**Contact No-8769191986**

---

**From:** Shankar Kumar Jha <jhashankarjha@gmail.com>

**Sent:** 02 July 2024 17:22

**To:** Ramjash Bhakal {रामजस भाकल} <bhakalramjash@powergrid.in>

**Cc:** vinod35292 <vinod35292@gmail.com>

**Subject:** Enabling Overcurrent & Earth Fault settings in 220 kV Mandola-Gopalpur Ckt.-1 & 2 at Mandola end

Dear sir,

Please enable Overcurrent & Earth Fault settings in 220 kV Mandola-Gopalpur Ckt.-1 & 2 at Mandola end as under :-

CT ratio at Mandola end - 800/1

Curve - IDMT Standard Inverse

Overcurrent PSM - 1200 Amp (150%)

Overcurrent TMS - 0.18

Earthfault PSM - 320 Amp (40%)

Earthfault TMS - 0.35

After enabling the above settings, please send the Distance and Line Differential relay settings of 220 kV Mandola-Gopalpur Ckt.-1 & 2 at Mandola end.

---

Thanks & Regards

**Er. Shankar Kumar Jha**  
**Sr. Manager (Protection)-III**  
**Delhi Transco Limited**  
**(A Govt. of NCT of Delhi Undertaking)**  
**Mobile No.-8700829197**



**Incident 1:** At 09:48:52 Hrs on 27/06/2024, Mandola-Gopalpur Circuit 2 tripped on Zone 2 protection, and both Zone 2 and Zone 3 protection were activated on Mandola-Gopalpur Circuit 1. It is important to note that the fault distance from the Mandola end was 27-28 km (line distance 22.48 km), and there was a fault current of 7.5 kA in both circuits at the time of the fault. Due to the non-clearance of the fault at the Gopalpur end, the fault was fed by all four ICTs at Mandola. During the fault, the current in the B-phase of all four ICTs at Mandola rose to six times the normal load current, causing significant stress on the ICTs and the switchgear in the associated bays of the ICTs and the affected lines for an extended period.

**Gopalpur 1 line Fault current-**

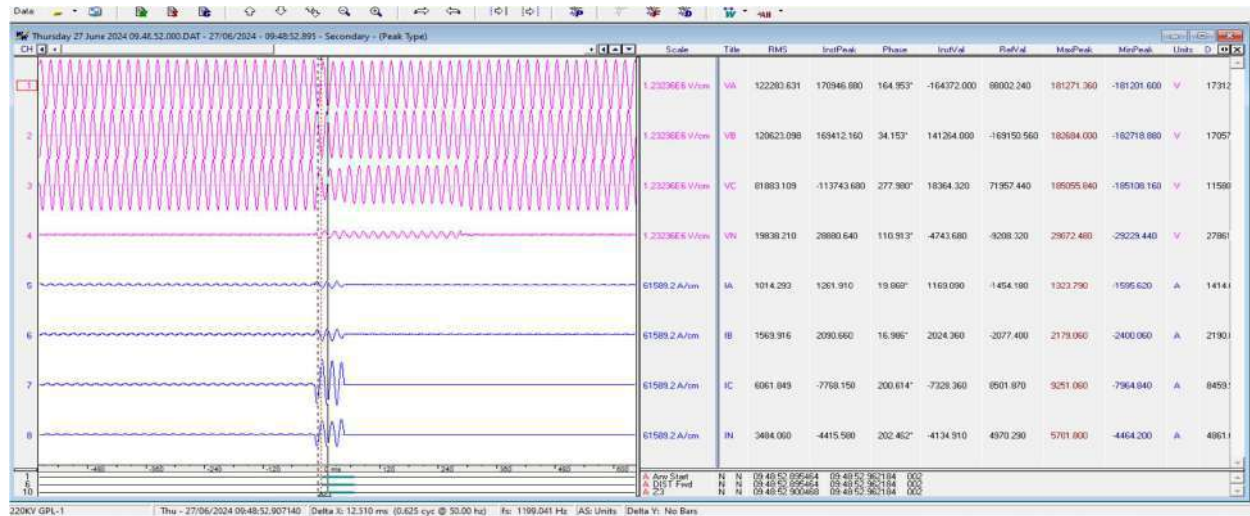

**Gopalpur 2 line fault current-**

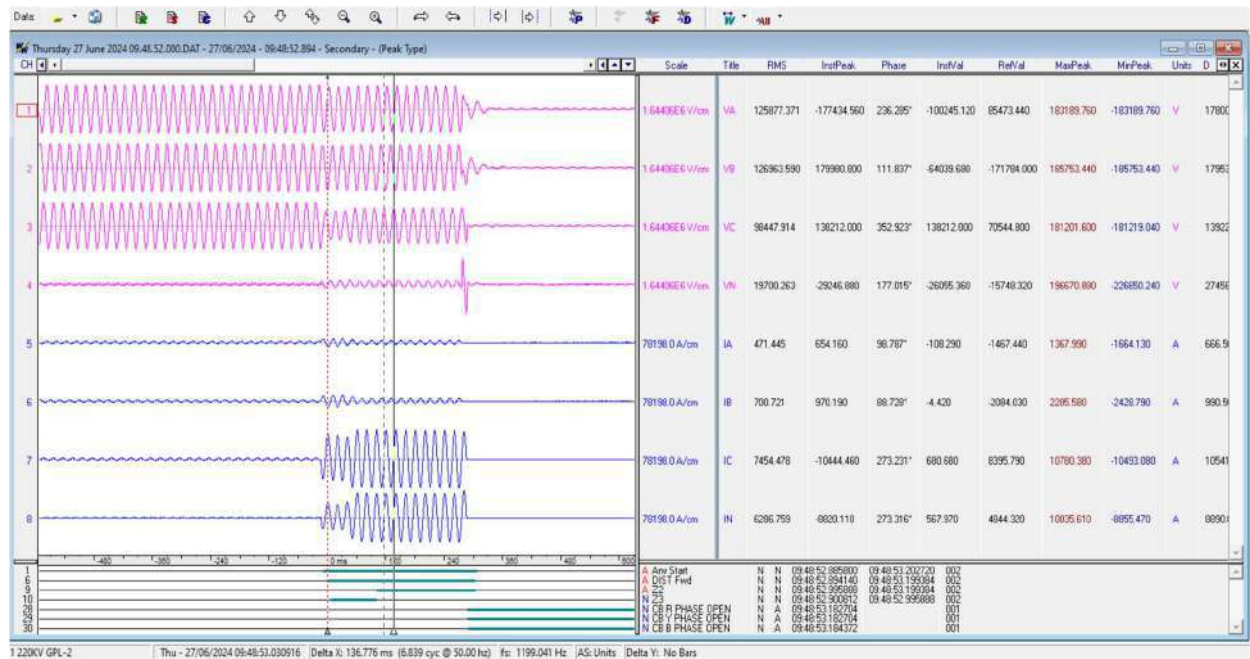

### 500 MVA ICT 2 Through fault current-

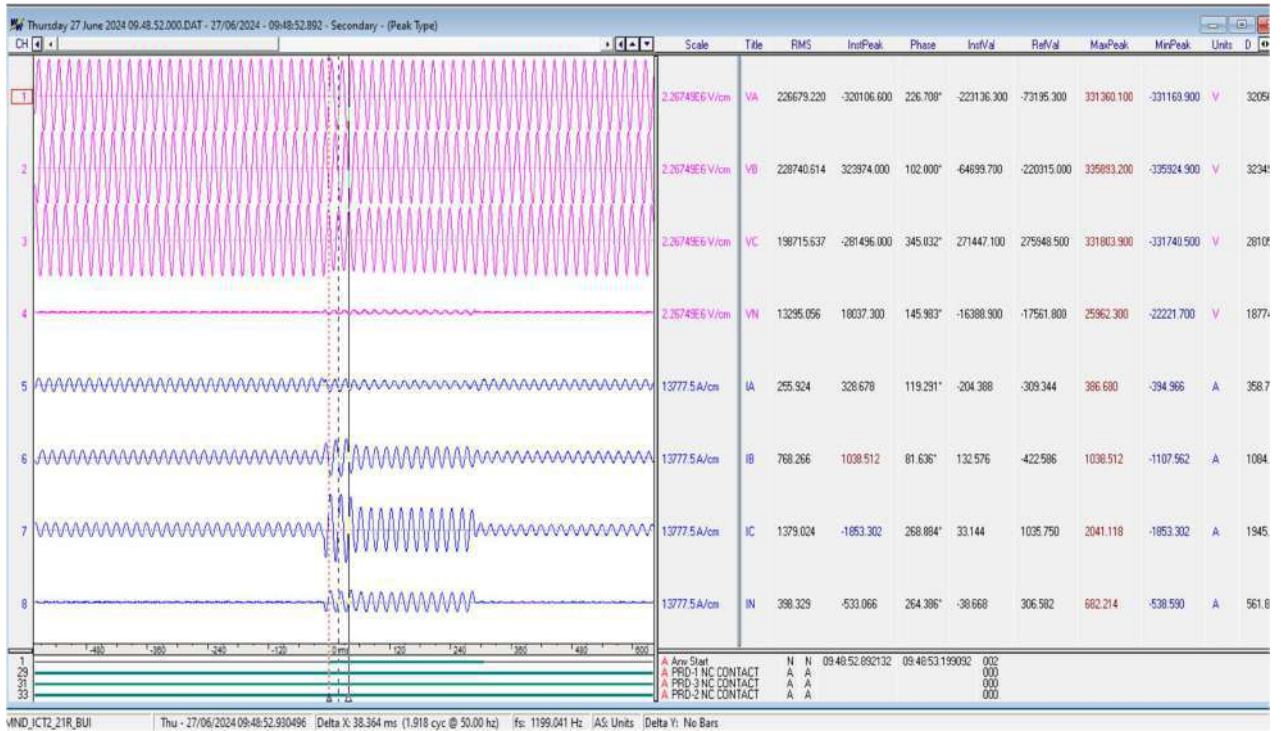

### 500 MVA ICT 4 Through fault current-

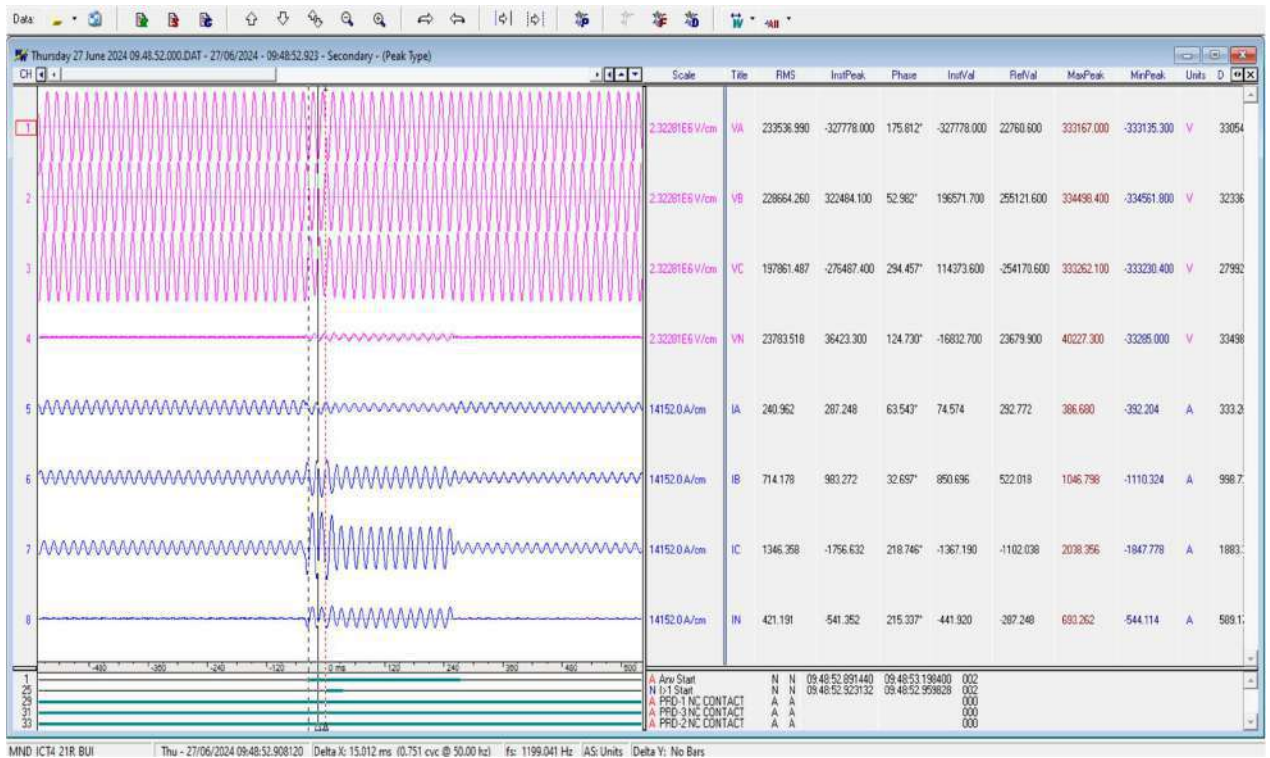



### 500 MVA ICT 1 Through fault current-

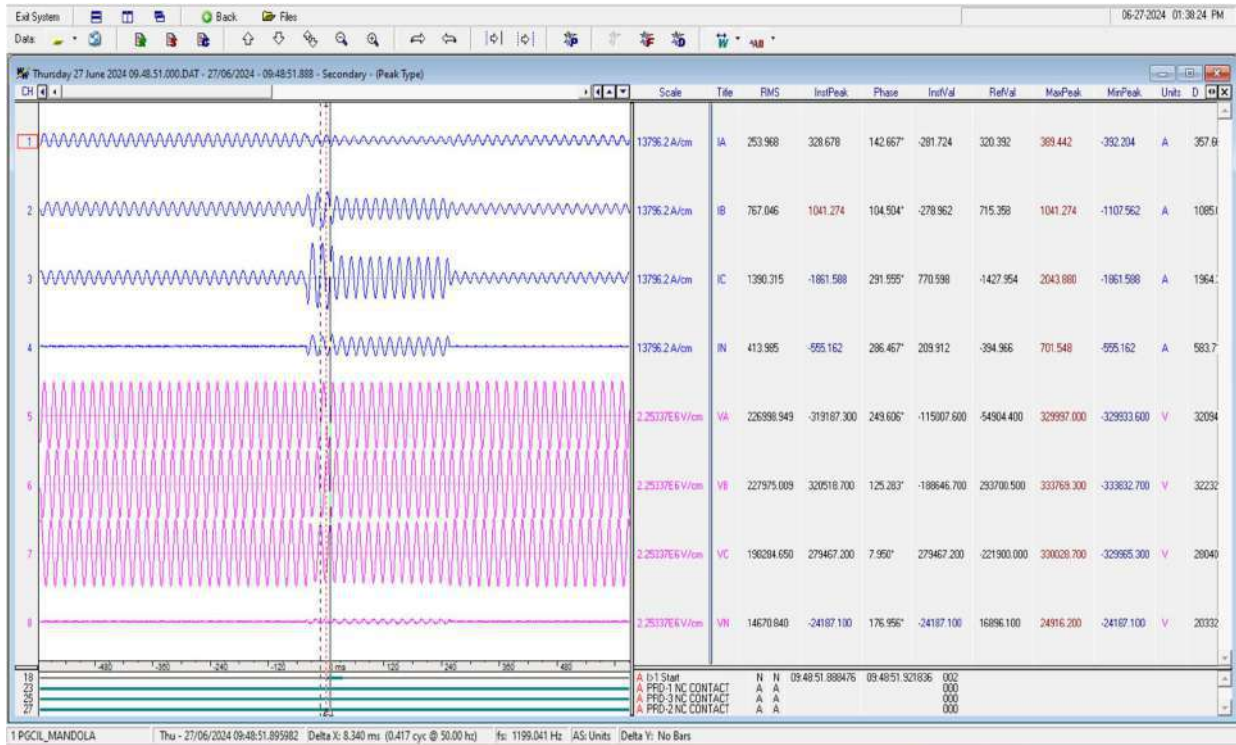

### 500 MVA ICT 3 Through fault current-

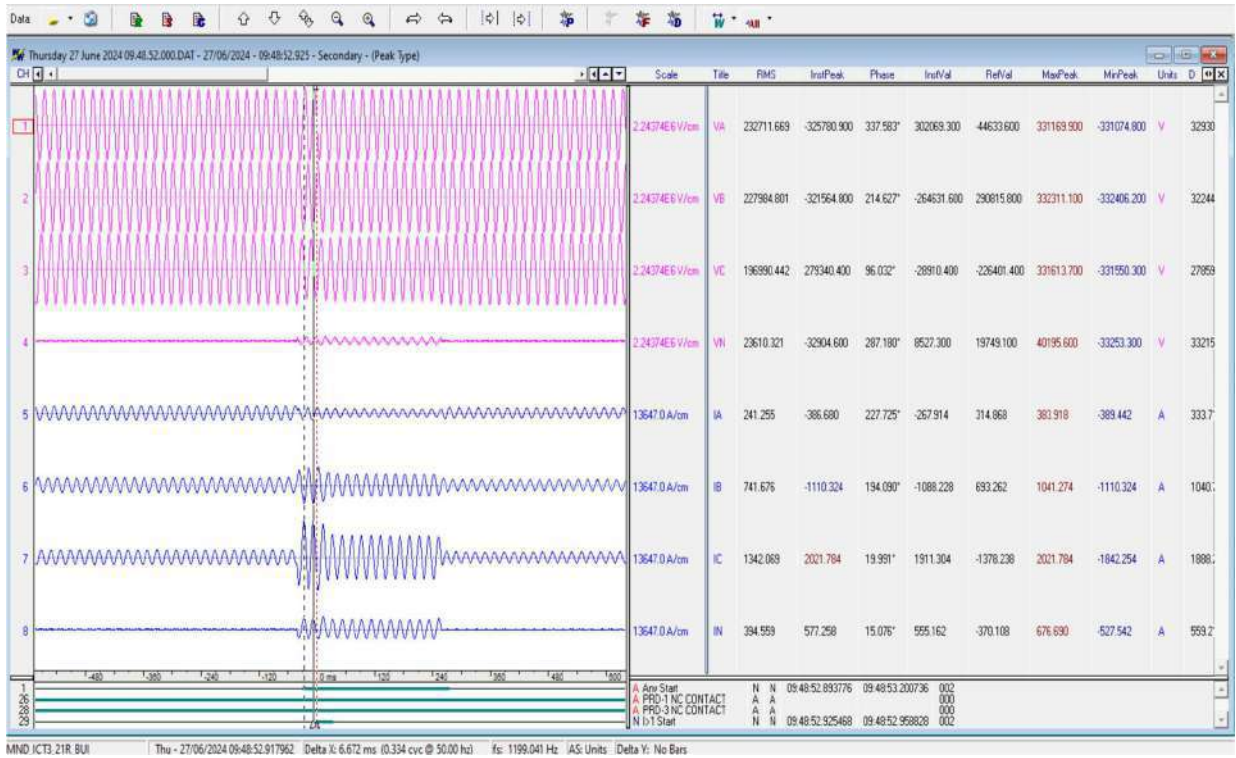

**Incident 2:** At 10:12:49 Hrs on 30/06/2024, the distance relays of Mandola-Gopalpur Circuits 1 and 2 picked up in Zone 3 protection and tripped due to a directional earth fault. It is important to note that the fault distance from the Mandola end was 27-28 km (line distance 22.48 km), and there was a fault current of 6.5 kA in both circuits at the time of the fault. Due to the non-clearance of the fault at the Gopalpur end, the fault was fed by all four ICTs at Mandola. During the fault, the current in the B-phase of all four ICTs at Mandola rose to six times the normal load current, causing significant stress on the ICTs and switchgear in the associated bays of the ICTs and the affected lines for an extended period.

**Gopalpur 1 line Fault current-**

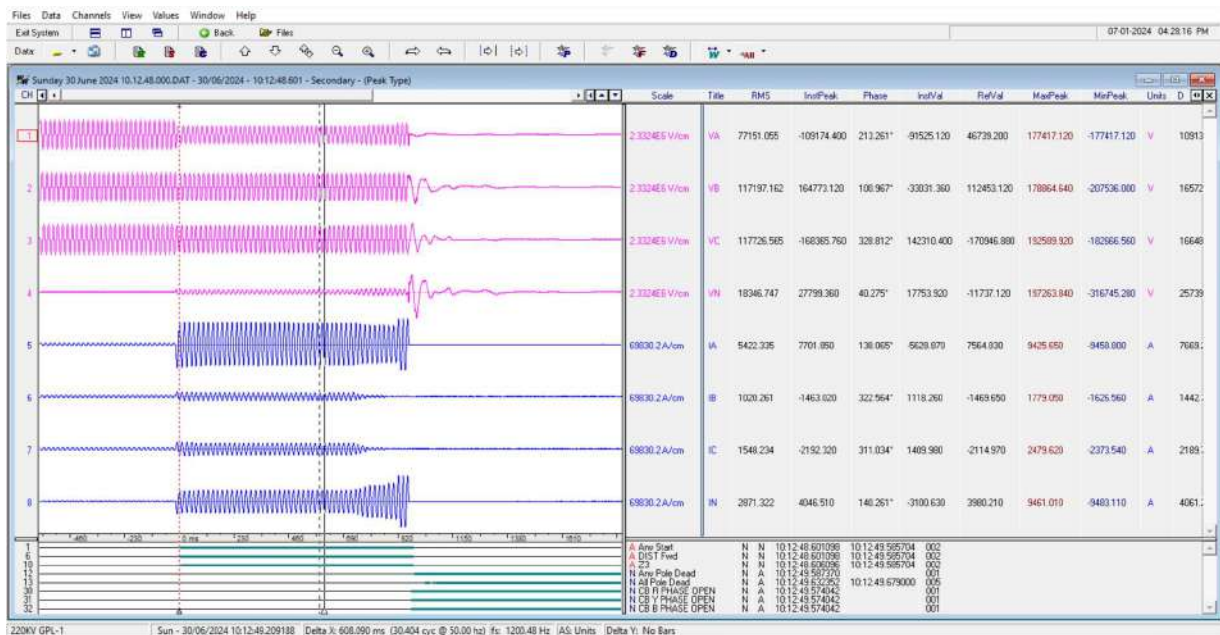

**Gopalpur 2 line fault current-**

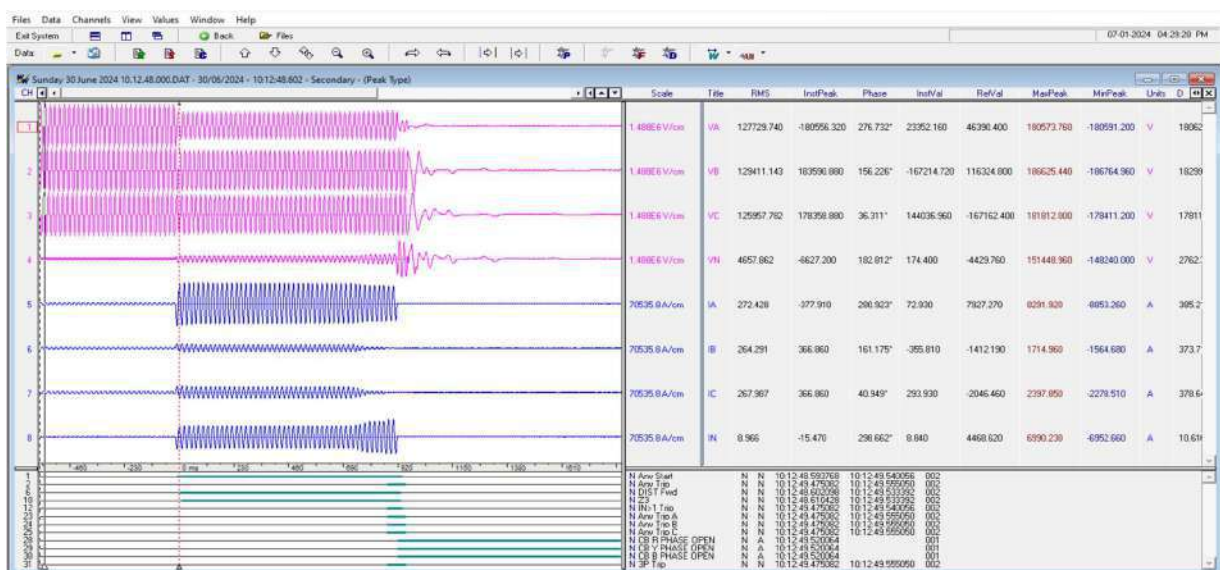



### 500 MVA ICT 2 Through fault current-

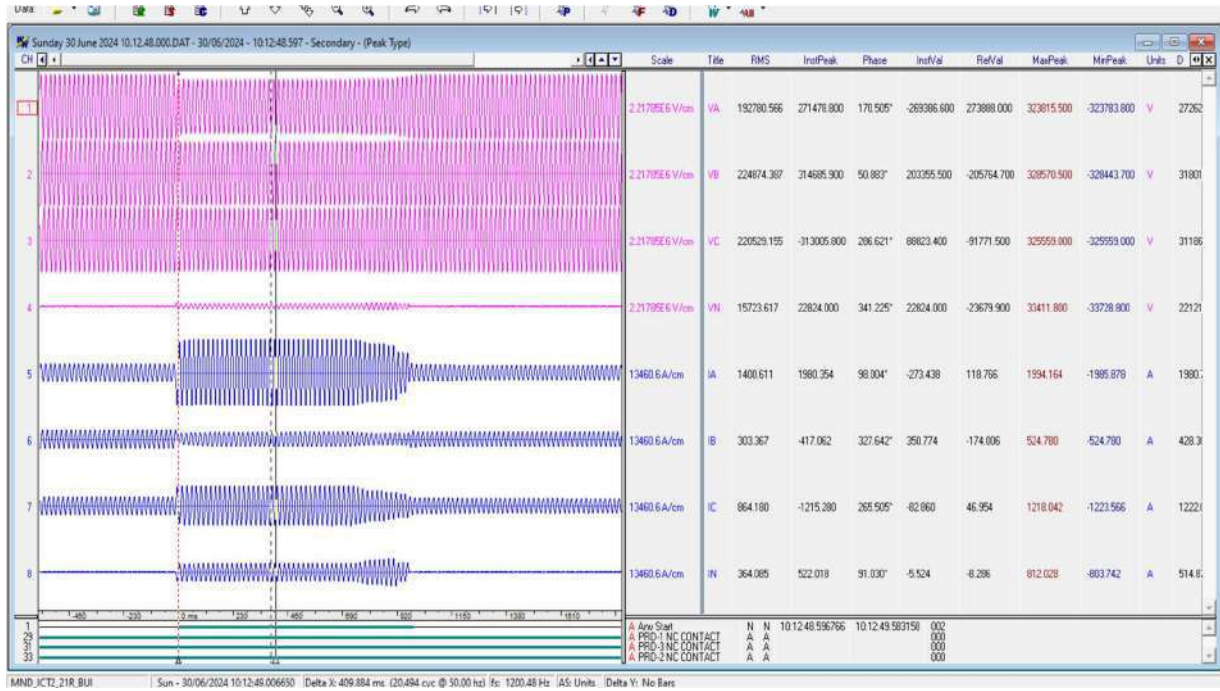

### 500 MVA ICT 4 Through fault current-

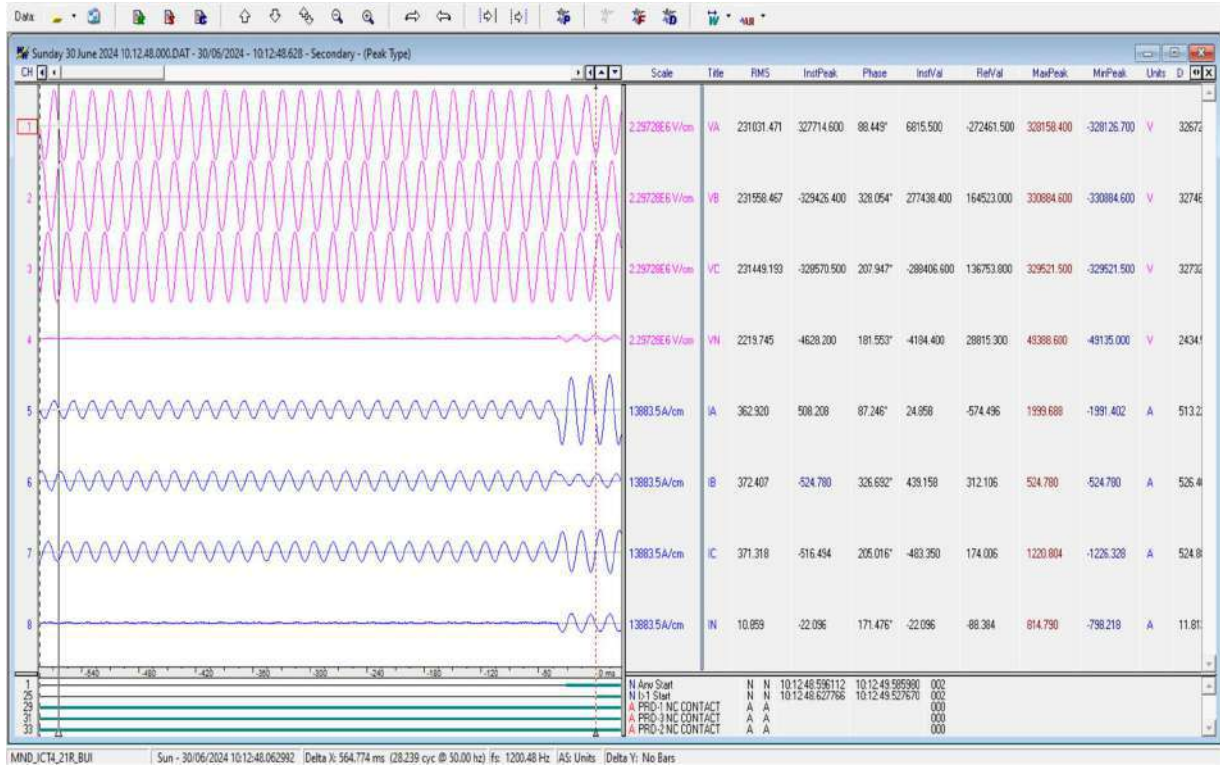



### 500 MVA ICT 1 Through fault current-

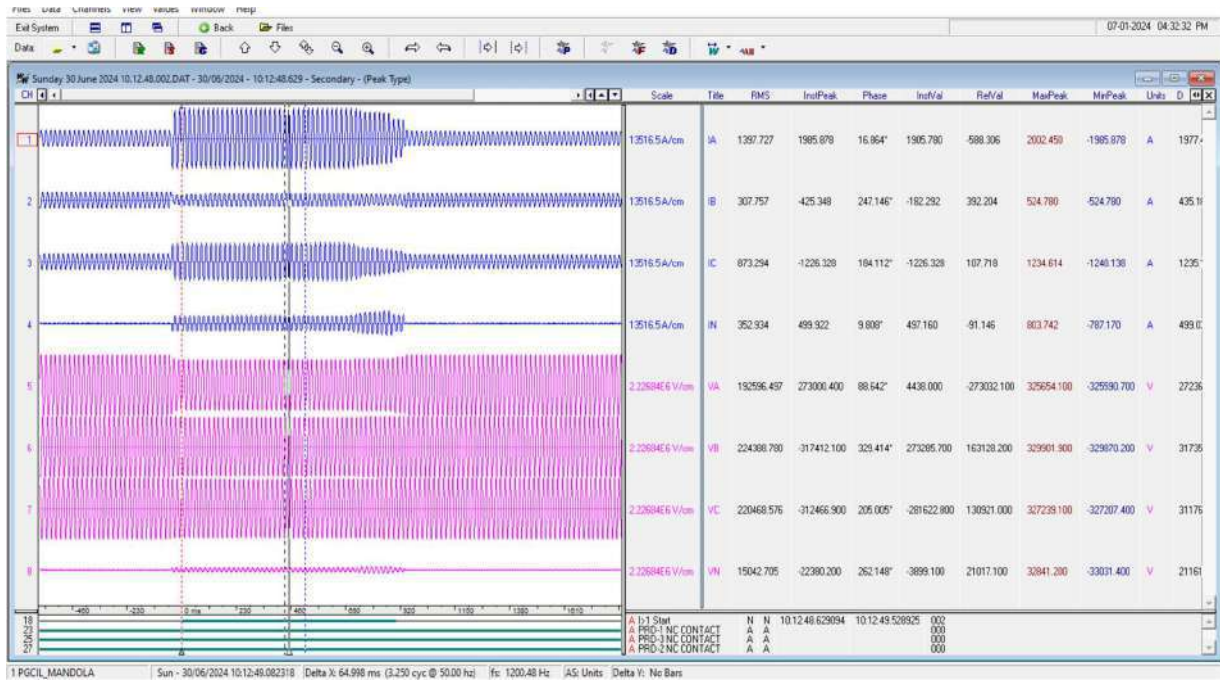

### 500 MVA ICT 3 Through fault current-

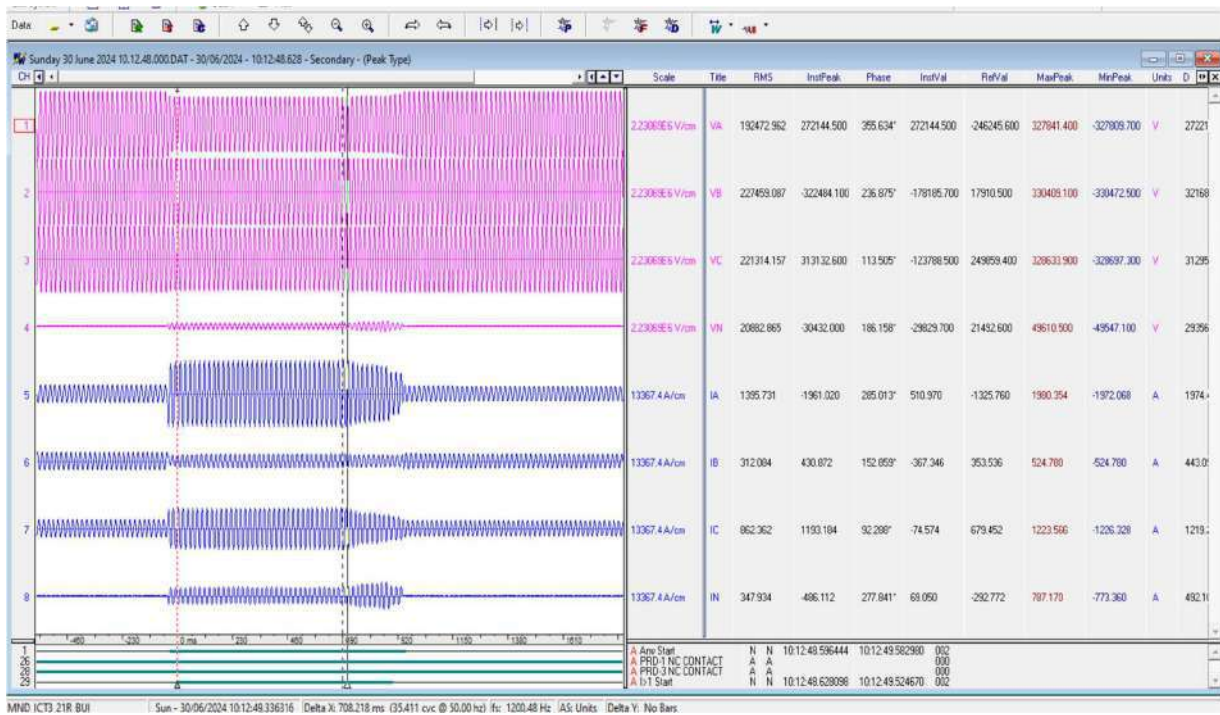

Date: 27.06.2024

Ref. No. N1SNP/SS/2024/

To  
SDO/Substation In-charge  
220KV Substation HVPNL, Mohana , Sonipat

**Subject:** - Discrepancy in protection system of 220KV Jaji(PGCIL) – Mohana(HVPNL) ckt 1 & 2**Reference:** - Letter no. N1SNP/SS/5125 dated 10.06.2023 (Enclosed)

Dear Sir,

This has reference to our office letter no. N1SNP/SS/5125 dated 10.06.2023 regarding discrepancy in protection at 220 KV Mohana Substation (HVPNL) end. It is once again observed that 220 KV Mohana Substation side faults are feeded from our 400/200 KV Substation(PG) through 220 KV Jaji (PGCIL) – Mohana (HVPNL) ckt 1 & 2. The protection system installed at Mohana (HVPNL) end were unable to clear the downstream fault/220kv Substation fault/Line fault within stipulated time. These faults being cleared by 220KV Jaji (PGCIL) end protection system every time in extended timings of Z2/Z3.

Details of recent faults which were cleared in Zone – 2/Zone – 3 timings at our end are as follows

**Case – 1**

220 KV Jaji (PGCIL) – Mohana (HVPNL) ckt 1

Date: - 15/05/2024, Time: - 23:12:12, Phase: - R-B ph.

Current - R ph. - 1.44 KA, B ph. – 1.46 KA, **Fault cleared by Jaji (PGCIL) in Zone – 3****Case – 2**

220 KV Jaji (PGCIL) – Mohana (HVPNL) ckt 2

Date: - 15/05/2024, Time: - 23:12:11, Phase: - Y ph.

Current – 1.359 kA, **Fault cleared by Jaji (PGCIL) in Zone – 3****Case – 3**

220 KV Jaji (PGCIL) – Mohana (HVPNL) ckt 2

Date: - 28/05/2024, Time: - 18:27:35, Phase: - R ph.

Current – 13.537 kA, **Fault cleared by Jaji (PGCIL) in Zone – 3**

From the above, it is clearly evident that the downstream fault of 220 KV Mohana Substation (HVPNL) were not clear by protection installed at 220 KV Mohana Substation (HVPNL). It is reiterated that failure of protection system of any element connected to National Grid may cause serious consequences to National Grid. Moreover, PLCC installed in 220KV Jaji (PGCIL) – Mohana (HVPNL) ckt 1 & 2 are not working due to which protection system is affected at our end.

In view of the above, it is requested to review the healthiness of the protection system installed at 220KV Substation, Mohana.

Thanking You

Your Faithfully

Attachments

Devendra Kumar, DGM, Sonipat SS

1) DR files of above incidents

उप केन्द्र: 400/220के वी उप-केन्द्र, गाँव जाजी, सोनीपत-गोहाना रोड, सोनीपत-131024(हरियाणा) दूरभाष 0130 2970027,

Sub-station: 400/220 KV Sub Station, Vill. Jaji, Sonapat-Gohana Road, Sonapat-131024, (Haryana) Tel: 0130- 2970027,

E-Mail: [pgsonipat@powergrid.co.in](mailto:pgsonipat@powergrid.co.in) GISTN.No.-06AAACP0252G1ZX

केन्द्रीय कार्यालय "सौदामिनी", प्लॉट नंबर 2, सेक्टर -29, गुरुग्राम -122001, (हरियाणा) दूरभाष: 0124-2571700-719

Corporate Office: "Saudamini", Plot No. 2, Sector-29, Gurugram-122001, (Haryana) Tel.: 0124-2571700-719

पंजीकृत कार्यालय वी -9, कुतुब इंस्टीट्यूशनल एरिया, कटवारिया सराय, नई दिल्ली -110 016. दूरभाष: 011-26560112, 26560121, 26564812, 26564892, CIN: L40101DL1989GOI038121

Registered Office: B-9, Qutab Institutional Area, Katwaria Sarai, New Delhi-110 016. Tel: 011-26560112, 26560121, 26564812, 26564892, CIN : L40101DL1989GOI038121

Website: [www.powergridindia.com](http://www.powergridindia.com)



Reference No.: N1SNP/SS/ 5125

Date: 10.06.2023

To

SDO/Substation In-charge

220 KV Substation HVPNL, Mohana , Sonipat

Subject: - Discrepancy in protection system of 220 kV Jaji(PGCIL)-Mohana(HVPNL) Ckt-1&amp;2

Dear Sir

It has been observed multiple times that 220 kV Mohana Substation sides faults are feeded to our 400/220 kV Substation through 220 kV Jaji(PGCIL)-Mohana(HVPNL) Ckt-1&2. Protection system installed at Mohana(HVPNL) end is not able to clearing the downstream fault/220 kV Substation fault/Lines fault within stipulated time. These faults being cleared by 220 kV Jaji(PGCIL) end protection system every time in extended timings of Z2/Z3/ZR.

Details of recent faults which were clear in Zone-2/Zone3 timings at our end are as hereunder.

**Case-1**

220 kV Jaji(PGCIL)-Mohana(HVPNL) Ckt-2

Date 10/05/2023 time 16.22:04, Phase- B

Current-5.61 kA, fault clear in by Jaji(PGCIL) in Zone-2

**Case-2**

220 kV Jaji(PGCIL)-Mohana(HVPNL) Ckt-2

Date 09/06/2023 time 21:09:43, Phase- R

Current-8.33 kA, fault clear in by Jaji(PGCIL) in Zone-2

**Case-3**

220 kV Jaji(PGCIL)-Mohana(HVPNL) Ckt-1

Date 10/06/2023 time 17:05:47, Phase- B

Current-3.187 kA, fault clear in by Jaji(PGCIL) in Zone-3

As per protection philosophy fault near to 220 kV HVPNL Substation shall be clear by protection system of 220 kV HVPNL Substation first then nearby substation's protection shall operate if first one fails to do so. It is here to reiterate that failure of protection system of any elements connected to National Grid may cause serious consequence to National Grid.

Moreover PLCC installed in 220 kV Jaji(PGCIL)-Mohana(HVPNL) Ckt-1&2 are not working due to which carrier Aided Function of our distance protection is not working for these feeder.

In view of above it is requested to please review the healthiness of protection system installed at 220 kV Substation Mohana.

Thanking You

*Receiving*  
*MK...*  
*14/6/23*

Yours faithfully

Devendra Kumar

Dy. General Manager, Sonipat SS

उप-केन्द्र: 400/220 के वी उप-केन्द्र, गाँव जाजी, सोनीपत-गोहाना रोड, सोनीपत-131024(हरियाणा) दूरभाष: 0130 2970027,

Sub-station: 400/220 KV Sub Station, Vill. Jaji, Sonapat-Gohana Road, Sonapat-131024, (Haryana) Tel: 0130- 2970027,

E-Mail: [pgsonipat@powergrid.co.in](mailto:pgsonipat@powergrid.co.in) GISTN.No.-06AAACP0252G12X

केन्द्रीय कार्यालय: "सादामिनी", प्लॉट नंबर 2, सेक्टर -29, गुरुग्राम -122001, (हरियाणा) दूरभाष: 0124-2571700-719

Corporate Office: "Saudamini", Plot No. 2, Sector-29, Gurugram-122001, (Haryana) Tel.: 0124-2571700-719

पंजीकृत कार्यालय: बी -9, कुतुब इन्स्टीट्यूशनल एरिया, कटवारिया सराय, नई दिल्ली -110 016. दूरभाष: 011-26560112, 26560121, 26564812, 26564892, CIN: L40101DL1989GOI038121

Registered Office: B-9, Qutab Institutional Area, Katwaria Sarai, New Delhi-110 016. Tel: 011-26560112, 26560121, 26564812, 26564892, CIN : L40101DL1989GOI038121

Website: [www.powergridindia.com](http://www.powergridindia.com)

Northern Regional Power Committee			
Centralized database of protection settings at RPCs for compliance of IEGC 2023			
Details of Substation & Relays for elements of 220 kV and above in Northern Region			
Sr. No.	Utility	Details	
		No. of Substation/Generating Station	No. of Relays
<b>Transmission</b>			
1	UPPTCL	194	4198
2	DTL	46	1387
3	HPPTCL	12	255
4	RVPN	143	7226
5	HVPN	90	2340
6	PTCUL	14	261
7	PSTCL	111	4523
8	JKPTCL	3	61
9	PGCIL	96	9172
10	Ghatampur Transmission Limited	0	29
11	Obra-C Badaun Transmission Ltd. (OBTL)	2	66
12	Western U.P. Power Transmission Co. Ltd	15	356
13	Adani Transmission (ATL, BKTL, FBTL)	7	205
14	INDIGRID	5	246
<b>Generation</b>			
15	UPRVUNL (Obra, Anpara-C, Anpara-D)	6	327
16	UJVNL	2	44
17	RVUNL	11	566
18	HPSEB (Generation & Transmission)	10	400
19	IPGCL	1	42
20	HPPCL	1	25
21	HPGCL	3	135
22	PSPCL	3	115
23	SJVN	2	64
24	NPL	1	46
25	NPCIL	5	122
26	NTPC (Rihand, Unchahar, Dadri)	7	437
27	BBMB (Generation & Transmission)	24	1078
28	NHPC	13	298
29	THDC	5	405
30	NUPPL Ghatampur	2	113
31	Prayagraj Power Generation Co. Ltd.	2	97
32	Meja Urja Nigam Private Limited (400KV, 2x660)	1	88
33	Rosa Power Supply Company Ltd	2	77
34	JAYPEE VISHNUPRAYAG HYDRO - ELECTRIC PLANT	1	14
35	ALAKNANDA HYDRO POWER COMPANY LIMITED	1	50
36	Adani Power Ltd. Kawai (2X660 MW)	1	57
37	Lalitpur Power Generation Company Limited	2	114
38	AD Hydro Substation	1	24
39	GREENKO	1	25
40	Aravali Power Company Pvt. Ltd	1	66
41	Apraava Energy Private Limited	1	12
42	Talwandi Sabo Power Ltd.	1	45
43	Lanco Anpara Power Ltd (Anpara-C)	2	118
44	JSW Energy Ltd. (KWHEP)	1	44
<b>Renewable Energy</b>			
45	ABC RENEWABLE ENERGY	1	15
46	ACME	2	32
47	Adani	16	251
48	CLEAN SOLAR POWER	2	28
49	EDEN RENEWABLE	1	9
50	TATA POWER RENEWABLE	1	32
51	THAR SURYA 1	1	8
52	TATA POWER Green Energy Ltd.	1	32
53	AMPlus Solar GRIAN Energy Pvt Ltd	1	20
<b>A</b>	<b>Total</b>	<b>878</b>	<b>35800</b>
<b>B</b>	<b>Assumption for addition as data is not received from few utilities (10%)</b>	<b>87</b>	<b>3580</b>
<b>C</b>	<b>Grand Total</b>	<b>965</b>	<b>39380</b>

**Scope of work for**  
**Centralized Database containing details of relay settings for grid elements**  
**connected to 220 kV and above**

Scope of software shall be broadly as below for all elements in Northern Region connected to 220 kV and above voltage level:

- A. Protection Settings Database Management System.
- B. Protection Setting Calculation and Study Tool.
- C. Repository of DR/EL and analysis.
- D. Application of protection settings by utilities and its approval by NRPC.
- E. Reporting of performance indices by utilities.
- F. Repository of protection audit reports.

**A. Protection Settings Database Management System**

1. To create facility to store all types of relay settings of all power system elements (connected to 220 kV and above in Northern Region such as lines, cable, ICT, Reactor/Capacitor, generator, GT, STATCOM/SVC, FSC/TCSC, HVDC) in one system irrespective of the manufacturer and relay type and controlled access to users.
2. Complete modeling of elements with relevant system parameters **based on data received from utilities** for transmission lines, generators, transformers, reactors, substation layouts, and associated protective relays in the substations. The model should include CT, PT, Isolator, Breaker and other bay equipment's ratings along with rating of the BUS and the type of conductor used for the BUS. The modeling should be done as per bus-breaker philosophy instead of node-oriented model.
3. Creation of necessary relay templates of all make and model existing in grid. **Template for electro-mechanical relay shall also be required to be created. Users shall have option to provide settings of electro-mechanical relay.**
4. Option to users to upload relay setting files (downloaded from relay) directly.
5. To capture the life cycle of protection settings and template.
6. To create an interface with Protection Setting Calculation and Study Tool.

7. To provide Role based access control.
8. Building the entire Northern region network data for load flow and fault calculation, Protection database and substation SLD preparation.
9. Hardware setup and software package capable of meeting the above objectives. Associated servers for installation and Deployment of application and database software along with standard Operating System –With Main and Back up.
10. Work flow Management.
11. Availability of historical fault data for predicting nature of fault.
12. The tool should be capable of analyzing, storing, and handling all fault records (Disturbance record, Event Logger, COMTRADE files, etc.) for a minimum period of prescribed years; and the updated database to be used for fault analysis should be permanently available.
13. Reports:
  - a. Feature to generate reports as per user requirement.
  - b. User can generate report in standard format like .xls, .pdf.
14. History log: All user activities such as user operations, data management, template management, configuration management and workflow shall be logged to track the user activities.
15. Import and Export: There shall be an option to import template and data from any third party application in standard formats like .xml and .xls
16. Relay characteristics curve can be drawn from the setting data.
17. Provision to attach documents to relay template and relay data can be made available. Option to accept setting data as per the audit and verify/compare the field setting with protection database setting and generate error report.
18. Provision to store and retrieve audit reports.
  - c. Provision to store and retrieve relay tripping incidence report.
  - d. Facility to store and retrieve setting guidelines as per various committees.
  - e. Automatic Reconciliation Tool should be available which will generate automatic reconciliation requests for relay settings in the database.
  - f. Up-to-date application guides and user manuals of all relays is a part of the relay library.
19. A user-friendly interface with features such as
  - a) Web based System.

- b) Role based access control
- c) Flexible customization of user roles, grants, actions from Master control panel
- d) User Access Monitor
- e) Relay Template Management
- f) Create\Edit\Delete relay templates
- g) Viewing relay template
- h) Locking and Unlocking templates
- i) Copy & Edit templates from the existing template
- j) Import and Export templates
- k) Relay Data management
- l) Create\Edit\Delete relay data
- m) Viewing relay data
- n) Locking and Unlocking relay data
- o) Copy & Edit relay data from the existing data
- p) Import and Export relay data

20. Built with standard relays library data for different manufacturers, including but not restricted to the following protection features:

- i. Transmission Line & cable (including compensated):**  
Distance, over current, earth fault, over voltage, Line Differential protection.
- ii. Power Transformer:**  
Differential Protection, Under Impedance protection, Over fluxing Protection, Thermal Overload Protection, Low Impedance Restricted Earth Fault Protection, High Impedance Restricted Earth Fault Protection, back-up over current (Directional/ Non-Directional) and earth fault protection (Directional/ Non-Directional).
- iii. Shunt Reactors:**  
Differential protection, Restricted Earth Fault, Back Up Protection (Impedance / overcurrent)
- iv. Generator:**  
Differential Protection, Stator Earth Fault Protection ( Both 95% and 100% protection), Inter – Turn Differential Protection, Backup impedance, Voltage Controlled O/C, Negative Sequence, Field Failure,



Reverse Power/Low forward Power, Pole Slipping, Overload, Over voltage, Under Frequency, Dead Machine, Rotor Earth Fault, Over Fluxing.

**v. Generator Transformer/ Unit Auxiliary Transformer:**

Differential Protection, Back up Earth Fault Protection, Back up over current, Restricted Earth Fault.

**vi. HVDC:**

- Converter Protection: Valve Short Circuit Protection, DC Differential Protection, DC Harmonic Protection, DC Under voltage Protection, DC Overvoltage Protection, AC Over voltage Protection, AC Under voltage Protection, AC Voltage Stress Protection of Converter, Group Differential Protection, Bridge Differential Protection, Overcurrent Protection, Sub-Synchronous Resonance Protection, AC Valve Winding Ground Fault Supervision,
- DC Filter Protection: Capacitor Differential Over current Protection, Capacitor Unbalance Supervision, Inverse Overcurrent Time Protection, DC Filter Differential Protection,
- DC Line Protection: Travelling Wave Front Protection, Under voltage Sensing Protection, Under voltage Operation Protection, DC Line Differential Protection, AC-DC Conductor Contact Protection.
- Electrode Line Protection: Electrode Bus Differential Protection, Electrode Current Balance Protection, Electrode Over Current Protection, Electrode line open circuit Over voltage Protection, Station Ground Overcurrent Protection, Open Conductor Electrode Line Protection
- DC Busbar Protection: HV Side DC Bus bar Differential Protection, Neutral Side DC Busbar Differential Protection, DC Differential Backup Protection, Valve Protection
- Converter Transformer Protection: differential protection, high impedance, restricted earth fault protection, ground earth fault overcurrent protection, thermal overload protection, over-fluxing protection, directional definite time / inverse-time overcurrent protection and directional earth fault overcurrent protection.



- AC Filter Sub-bank Protection (Shunt/Capacitor/Resistor): Differential, overcurrent, overload, unbalance supervision, Zero Sequence Overcurrent.

**vii. STATCOM:**

- Transformer Protection: Differential protection, REF protection, Directional Overcurrent protection, Ground Overcurrent, over flux protection, Transformer mechanical trips.
- STATCOM (MV) Bus protection: Bus Differential protection, Ground over current protection, used with neutral Grounding Transformer, Under/ Over Voltage protection, Over voltage (Open Delta) protection.
- STATCOM Branch Protection: Differential protection and/or O/C protection, Ground over current protection , Valve Overcurrent protection (in Controls), DC overvoltage protection (in Controls)
- MSR/TCR Branch Protection: Differential protection, Ground over current protection, Reactor branch unbalance protection, Thermal Overload protection.
- MSC/TSC Branch Protection: Differential protection, Ground over current protection, Capacitor Overvoltage (Using current signal) protection, Capacitor unbalance protection, over current protection.
- Harmonic Filter Protection: Ground over current protection, Capacitor Overload (Using current signal) protection, over current protection, Neutral Voltage shift.
- Auxiliary Transformer Protection: Over current, open delta voltage protection.

**viii. SVC:**

- Coupling Transformer (HV & MV) Protection: Differential protection, REF protection, Directional Overcurrent protection, Ground Overcurrent, over flux protection, Transformer mechanical trips.
- SVC Bus Bar protection: Bus Differential protection, Ground over current protection, used with neutral Grounding Transformer, Under/ Over Voltage protection, Over voltage (Open Delta) protection.

- TCR Protection: Differential protection, Ground over current protection, Reactor branch unbalance protection, Thermal Overload protection.
  - TSC Protection: Differential protection, Ground over current protection, Capacitor Overvoltage (Using current signal) protection, Capacitor unbalance protection, over current protection.
  - Harmonic Filter Protection: Differential protection, Ground over current protection, Capacitor Overvoltage (Using current signal) protection, Capacitor unbalance protection, over current protection, Neutral Voltage shift.
  - Auxiliary Transformer Protection: Over current, open delta voltage protection.
- ix. **FSC & TCSC:** Capacitor unbalance, Capacitor overload, Line current supervision, MOV overload, MOV short term energy protection, MOV high current protection, MOV high temperature protection, MOV failure protection, Flashover to platform protection, Spark Gap protection, Trigger circuit supervision, Sub-harmonic protection, Pole disagreement protection, Bypass switch failure protection,
- x. **BUSBAR & LBB:** Differential protection, Beaker Failure Protection
21. Protection Settings Database Management System shall be suitable for integration with other portals, software of protection. It shall be able to integrate any third party application to share data between protection database management software and calculation engine/tool and vice versa.
22. Training of utilities.
23. AMC.

## **B. Protection Setting Calculation and Study Tool.**

This module shall be capable of giving recommendation of Protection Setting for protections of elements as mentioned under point no. 20 of para A. Calculation Tool should be capable of performing the following:

1. Relay co-ordination for power system elements. Co-ordination check shall be conducted for relays of all make.
2. Primary/back-up relay pairs generation.
3. Fault calculation will be a part of relay co-ordination program.

4. Transparent Fault calculation results.
5. Simulation engines for protection co-ordination, power flow analysis, fault calculation, transient stability studies, electromagnetic transient analysis, and protection relay operation post-mortem analysis. There should be features to study low frequency oscillations, 3rd zone tripping, PSS tuning support and Voltage collapse prediction feature.
6. The protection calculation tool should be capable of interacting with the relay data in the database.
7. Tool for simulating the performance/ behavior of the protection system under all possible normal and abnormal operating conditions of the power system, including effect of changing one or more parameter setting of the relays.
8. Diagnostics Tool for verifying proper coordination among various protective relays.
9. Computation of critical clearing time.
10. Plotting Log-Log grid and graphs.
11. Option to check existing relay settings with respect to field or vice versa.
12. Computation of Out of Step Tripping Protection Settings.
13. Display of sequence operation of relays with respect to tripping time.
14. Switching status for all relays elements from the screen.
15. Association of relays to power system elements.
16. Disturbance analysis can be done on mapping of disturbances files with corresponding relay.
17. It shall have standard power system components and relay symbols.
18. Automatic computation of zone setting for distance protection.
19. Feature for viewing existing and newly computed relay settings.
20. Pre-loaded standard relay curves.
21. Directional and non-directional feature for relays.
22. Overload factor, unbalance factor and discrimination time (user defined/selectable) for each relay.
23. Inbuilt discrimination time calculator for grading of relays.
24. Facility to model the back-up protection settings of generating units / GTs.

### **C. Repository of DR/EL and analysis.**

- a) Platform for upload of DR/EL by utilities and access to all.

- b) Tracking of non-compliance in uploading.
- c) Tool for analysis of DR/EL.
- d) Tool shall be integrated with outage portal of NRLDC so that it can capture details of outages of elements automatically from NRLDC portal so that users can upload DR, EL, FIR, tripping report, analysis report.**

**D. Application of protection settings by utilities and its approval by NRPC.**

- a) Platform for application of protection setting by utilities.
- b) Hierarchical role for scrutiny and approval of setting by NRPC.
- c) Intimation of approval of settings by NRPC.
- d) Intimation of implementation of settings by utilities.

**E. Reporting of performance indices by utilities.**

- a) Platform for reporting of performance indices by utilities.
- b) Feature for scrutiny and intimation of errors to utilities by NRPC.
- c) Recording of justification note for non-compliance.

**F. Repository of protection audit reports.**

- a) Platform for reporting of internal and external audit report of all utilities.
- b) Tracking non-compliance and next due date.
- c) Web-based Checklist for protection audit should be made available for Constituents to self-auditing.

\*\*\*\*\*

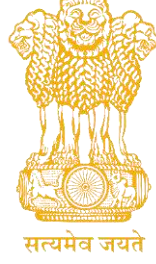

**उत्तर क्षेत्रीय विद्युत समिति**  
**NORTHERN REGIONAL POWER COMMITTEE**

**Procedure for Approval of Protection  
Settings in Northern Region**

**(In reference to regulation 14 of IEGC 2023)**

**Version: 1.0**

***(Approved in 75<sup>th</sup> NRPC meeting held on 28.08.2024)***

**August, 2024**

## **A. Procedure in case of new element charging**

1. ISTS users shall submit the protection settings to NRPC and NRLDC for every new element to be commissioned one month in advance through mail.  
In case of intrastate elements, users shall submit the protection settings to NRPC and concerned SLDC for every new element to be commissioned one month in advance through mail.
2. NRLDC based on the above information and the First Time Charging (FTC) request by user through Outage Management System (OMS) portal of NRLDC, shall allow integration of new element in the system as per NRLDC FTC procedure with the prevailing practice to avoid any delay in charging of the new element. The settings shall be treated as provisional arrangement till approval in PSC (Protection Sub-Committee).  
In case of intrastate elements, SLDC shall allow integration of new element in the system. This shall be treated as provisional arrangement till approval in PSC.
3. NRLDC/SLDCs may ask any other relevant data/information from concerned utilities during scrutiny of settings.
4. Users will be responsible for any revision in settings of the existing element required due to charging of new element. The settings shall be treated as provisional arrangement.
5. The concerned utility shall put up the agenda for getting final approval in next PSC.
6. NR PSC will review and approve the final settings based on the inputs submitted by the utility. In case of any change required in final protection settings of the new element than the provisional one, as decided by the committee, the same shall be implemented within 7 days by the concerned utility.
7. Utility shall intimate to NRPC Secretariat and NRLDC/SLDC (as applicable) within fortnight after implementation of settings for record in regional protection settings database.

## **B. Procedure in case of revision of settings of any existing element (without any changes in network configuration):**

1. Any change in the existing protection settings shall be carried out only after prior approval from PSC Forum of NRPC.
2. The concerned utility (both ISTS and intrastate) shall put up an agenda regarding any changes required in existing protection settings due to integration of new element in the existing system or otherwise, in PSC.
3. Utility shall intimate to NRLDC/SLDC (as applicable) and NRPC about the changes implemented in protection system or protection settings within 15 days of such changes.

\*\*\*\*\*

**Status of actions points recommended during previous PSC meetings (to be discussed in 55th PSC meeting)**

**Annexure-B.I**

S. No	Agenda	Remdial actions recommended during PSC meeting	Status of remdial action taken (to be updated by respective constituents)		
			52nd PSC (20.09.2024)	53rd PSC (22.10.2024)	54th PSC (25.11.2024)
1	Frequent multiple elements tripping at 220kV Kunihar, Baddi, Upperia Nangal complex and load loss event in HP control area	<b>51 PSC:</b> PSC Forum requested HP to complete the protection audit as per mentioned timelines (protection audit of 220kV Kunihar has been awarded and it would be completed within next 15-20 days. In next phase, by 15th September, protection audit of substations in downstream and upstream of 220kV Kunihar S/s would be completed.) and resolve the protection related issues. HP was also requested to share the reports of protection audit to NRPC & NRLDC after completion of audits.	1. Protection audit of 220kV Kunihar has been awarded to POWERGRID on 09th July 2024 and it would be completed by October 2024. 2. In next phase, protection audit of substations in downstream and upstream of 220kV Kunihar S/s would be completed, tender process of rest of the stations is in process.	HPSEBL representative informed that <b>protection audit of 220kV Kunihar was done during between 17-19th October 2024</b> . Award of protection audit of other stations is yet to be done. Audit report of Kunihar S/s shall be submitted in a week.	HPSEBL representative informed that <b>compliance report of protection audit at Kunihar S/s has been submitted yesterday(24.11.2024)</b> . Protection audit of rest of the stations will be conducted by the end of December 2024.  <i>PSC forum requested HPSEBL to expedite the process of protection audit of other stations. It was also requested to share the reports of protection audit to NRPC &amp; NRLDC after completion of audits. HPSEBL shall take expedited actions to comply the protection system related shortcomings (highlighted in audit) at 220kV Kunihar S/s</i>
2	Multiple elements tripping at 220kV Hissar(BBMB) 07th May 2024, 11:16 hrs	<b>51 PSC:</b> a) Expedite the implementation of differential protection in short lines to avoid undesired operation of distance protection.	HVPNL representative informed that clearance related to OPGW received from POWERGRID. Matter was forwarded to design team and is pending at that stage.	BBMB representative stated the matter has been taken up with HVPNL and is pending at their end. HVPNL representative informed that design team has compiled all such requirements in Haryana control area and is not working on the further process.	HVPNL representative informed that existing earth wire is normal earth wire which is to be replaced with OPGW. Process of the same has been started. After this, process of implementation of differential protection will be started.  <i>PSC forum recommended HVPNL to expedite the implementation of differential protection in short lines.</i>
3	Multiple elements tripping at 400/220kV Akal (RS) on 08th Jun 2024, 19:53 hrs	<b>51 PSC:</b> a) Bus bar protection at 220kV bus at 400/220kV Akal shall be made operational at the earliest. b) Time synchronization of recording instruments (DR/EL) need to be ensured.	Rajasthan representative stated that three faulty PU were replaced from the future bay and one PU is still unhealthy which is in warranty period. Process is getting delayed due to lack of response from the OEM. Process will be expedited and will try to resolve the bus bar protection issue on priority.	RVPNL representative stated that correspondence with the firm is still going on and as an alternative, possibility of replacing healthy PU from any other station is being explored. Issue of time sync will be able to resolve only if bus bar protection get operational.	RVPNL representative stated that issue not resolved yet, continuous follow-ups are being done. RVPNL agreed to resolve the issues by the end of 2024 (December 2024). NRLDC representative suggested RVPNL to purchase new PU if OEM is not supporting.  <i>PSC forum recommended RVPNL to expedite the process and make bus bar protection at Akal S/s healthy &amp; operational at the earliest.</i>
4	Multiple elements tripping at 400kV Sainj (HP), 400kV Parbat2 & Parbt3 (NHPC) Stations on 07th May 2024, 16:17 hrs	<b>51 PSC:</b> a) NHPC shall follow up with the relay engineer and taken necessary remedial actions to ensure proper operation of A/R scheme at Parbat2 end. b) NHPC and HPPCTL shall review the healthiness of PLCC at Parbat3 and Sainj end and take necessary actions to ensure their proper operation. c) Expedite the implementation of differential protection in 400kV Parbat2-Sainj line. d) Standardisation of recording instruments (DR/EL) need to be ensured.	1.Shutdown has been planned in 1st week of November 2024, testing of A/R scheme and implementation of differential protection will be done during that period. 2. PLCC card at Parbat3 end will be replaced by the end of September 2024. For dual test of PLCC operation, PLCC at Sainj end also need to be healthy.	As per details received from NHPC present status is as follows: •Due to unavailability of OEM, shutdown plan has been now rescheduled in last week of November or 1st week of December. Testing of A/R scheme and implementation of differential protection will be done during that period. • <b>PLCC card at Parbat3 end has been replaced</b> and made functional. However, for dual test, PLCC at Sainj end also need to be functional.	NHPC representative informed that status is same. Implementation of differential protection & testing of A/R in 400kV Parbat2-Sainj line will be completed by December end. Further, PLCC at Sainj HEP end also need to be healthy for testing of PLCC at Parbat3 end and proper operation of carrier communication in line.  <i>PSC forum recommended NHPC to expedite the process at their end and HPPCTL was requested to follow up with HPPCL for necessary actions required at Sainj HEP.</i>
5	Multiple elements tripping at 400kV Khedar(RGTPS) Station at 10th May 2024, 19:35 hrs	<b>51 PSC:</b> a) Revised corrected protection settings of Main-2 Micome P4442 distance protection relay and A/R scheme at Khedar(RGTPS) end need to implemented at the earliest.	HVPNL representative informed that Khedar(RGTPS) have conducted 3rd party protection audit. Status of corrective action taken yet to be confirmed.	Khedar RGTPS representative informed that issues with the settings of the Micom relays has been resolved however in REL 670 relay installed at Khedar end, only 1-ph A/R option is not available. 3-ph A/R has been disabled now and it has been kept as 1-ph/2-ph A/R.	RGTPS representative informed that OEM has agreed to revise the logic of A/R function in relay and issue related to A/R operation will be resolved at the earliest.  <i>PSC forum requested RGTPS &amp; HVPNL to ensure the desired correction in logic of A/R function at Khedar TPS at the earliest.</i>
6	Multiple elements tripping at 400kV Koteshwar(PG) on 17th May 2024, 17:21 hrs	<b>51 PSC:</b> a) In view of short line length of 400kV Koteshwar(PG)-Tehri D/C, POWERGRID shall plan for the differential protection in the line on priority in near future to avoid overreach of distance protection.	Update yet to be received	POWERGRID (NR-1) representative informed that order for the material of differential protection has been placed. It is estimated that materials will get delivered in next 3-months. <b>In addition, to avoid delayed fault clearance in case of high resistive fault, time delay of DEF protection and carrier aided DEF operation has been implemented.</b>	POWERGRID(NR-1) representative informed that, material for differential protection is expected to be arrived by the end of December 2024 and the same will be implemented by the end of January 2024.  <i>PSC forum requested POWERGRID(NR-1) to expedite the process of implementation of differential protection at Koteshwar HEP</i>
7	Multiple elements tripping at 220kV Sarna (PS) on 04th May 2024, 07:10 hrs	<b>51 PSC:</b> a) Punjab shall expedite the commissioning of new bus scheme. B) POWERGRID shall revise the Z-4 time delay setting of Kishenpur lines at Sarna (PS) end as 160msec till bus bar get operational.	Punjab representative informed that tender of bus bar protection has been processed, bus bar protection at 220kV Sarna will be commissioned within 4-5 months tentatively.	PSTCL representative informed that tender of bus bar scheme is in process. <b>POWERGID(NR-2) representative informed that Z-4 time delay setting of lines of their control area has been revised.</b>	During 54th PSC meeting, PSTCL representative stated that process is still at the tender stage. It will be commissioned in next 3 months.  <i>PSC forum requested PSTCL to expedite the process of bus bar protection implementation at 220kV Sarna(PS).</i>
8	Multiple elements tripping at 400/132kV Masoli(UP) on 29th May 2024, 15:57 hrs	<b>51 PSC:</b> a) Up shall implement the bus bar protection at 132kv level at 400/132kV Masoli S/s.	UP representative informed that this case has been communicated to design team. In response, they have asked the list of all such stations in UP control area. Further follow up actions is expected in due time course.	UPPTCL representative informed that process is still at the design team stage. Design team is compiling all such requirements and further process will be initiated within 1-2 months.	UPPTCL representative informed that process is still at the design team stage. Continuous follow ups are being done for expeditious implementation of bus bar protection at such stations.  <i>PSC forum requested UPPTCL to expedite the process of bus bar protection implementation at 400/132kV Masoli(UP) and such other stations.</i>
9	Multiple elements tripping at 220kV KTPS (RVUN) on 21st June 2024, 11:37 hrs	<b>51 PSC:</b> a) Commissioning of bus coupler between 220kV Bus-3 & 5 need to be expedited.	KTPS representative informed that tender for the same has been floated.	RVUNL representative informed that process is at same stage. It will take around 01 year to complete all the process and implementation of bus coupler.	RVUNL representative stated that whole process will take time. Tender process is completed, and review meeting is scheduled on 25th December 2024.  <i>PSC forum requested KTPS to expedite the process.</i>

10	Frequent tripping of 220 KV Anta(NT)-Sakatpura(RS) (RS) Ckt-1	<b>52 &amp; 53 PSC:</b> RVPN was requested to expedite the process of relay replacement and rectification of issues related to A/R operation.	Regarding non-operation of A/R, Rajasthan representative informed that relay penal is old, same is planned to be replaced with new within one month.	RVPNL representative informed that request of relay panel has been floated however DI of the same is yet to be issued.	RVPNL representative informed that existing panels are of simplex type which have to be replaced with duplex panels. Panels have been issued however civil work is required for installation of the same. Delay is due to civil work.  <i>PSC forum requested RVPNL to expedite the process.</i>
11	Frequent tripping of 220 KV Saharanpur(PG)-Shamli(UP) (UP) Ckt-1	<b>52 &amp; 53 PSC:</b> POWERGRID shall review and ensure the A/R operation at their end.	POWERGRID representative stated that they will review the status of A/R operation at Saharanpur(PG) and shall ensure its proper operation in future.	PSC forum requested POWERGRID to review the healthiness of A/R in lines at Saharanpur(PG) end. Any issue in A/R operation need to be rectified at the earliest and A/R should be kept enable. UPPTCL shall take necessary actions to minimise the occurrence of faults in line.	<b>POWERGRID(NR-1) representative informed that, A/R function in the line has been reviewed and it is healthy and operational.</b> He further raised concern over frequent faults in line. UPPTCL representative stated that they will take necessary remedial actions to minimise the frequent faults in the line.  <i>PSC forum requested UPPTCL to take necessary actions to minimise the occurrence of faults in line. POWERGRID shall ensure the proper operation of A/R in line.</i>
12	Frequent tripping of 220 KV Khara(UP)-Saharanpur(PG) (UP) Ckt-1	<b>52 &amp; 53 PSC:</b> UP was requested to expedite the process of relay replacement at Khara end. POWERGRID shall review and ensure the A/R operation at their end.	UP representative informed that new relay is available at site. Relay will be replaced during lean season as per the shutdown opportunity.	PSC forum requested POWERGRID to review the healthiness of A/R in lines at Saharanpur(PG) end. Any issue in A/R operation need to be rectified at the earliest and A/R should be kept enable. UPPTCL shall expedite the replacement of relay at Khara(UP) end.	UPPTCL representative informed that all the line protection relays at Khara(UP) are of electromechanical type. Relays will be replaced with numerical relays by the end of December 2024.  <i>PSC forum requested UPPTCL to expedite the replacement of relay at Khara(UP) end. POWERGRID shall ensure the proper operation of A/R in line.</i>
13	Multiple elements tripping event at Patiala(PG)	<b>52 &amp; 53 PSC:</b> POWERGRID was requested to expedite the process of commissioning of new bus bar scheme.	Continuous follow ups are being done for expeditious delivery of material. Thereafter, new bus bar protection will be implemented.		POWERGRID(NR-2) representative informed that materials have been arrived. Presently, team is working at Nallagarh(PG) S/s, thereafter work will start at Patiala(PG). Implementation of new bus bar protection at Patiala(PG) will be completed by the end of January 2025.  <i>PSC forum requested POWERGRID(NR-2) to expedite the process.</i>
14	Frequent tripping of 220 KV Nara(UP)-Roorkee(UK) (UP) Ckt-1	<b>53 PSC:</b> PTCUL was requested to analyse the tripping events and take necessary remedial action to avoid undesired tripping.		PTCUL representative agreed to analyse the event and share the analysis.	<i>PSC forum recommended following actions to PTCUL:</i> a) A/R shall be enabled in the line. Any issues may be put up in the PSC forum. b) Root causes analysis of the frequent tripping of line need to be submitted. c) Necessary remedial actions need to be taken to avoid frequent tripping of the line.
15	Frequent tripping of 400 KV Agra-Unnao (UP) Ckt-1	<b>53 PSC:</b> UP shall share the DR of overvoltage tripping of 400kv Agra-Unnao ckt-1 and analyse the root cause of tripping.			UPPTCL representative informed that overvoltage relay at Unnao (UP) is of electromechanical type. Binary output ports in existing distance protection relay is exhausted. Solutions are being explored, issue will be resolved shortly.  <i>PSC forum requested UPPTCL to take necessary remedial action to resolve the issue.</i>
16	Multiple elements tripping at 220kV Khodri HEP & Chibro HEP on 5th, 11th & 19th September 2024	<b>53 PSC:</b> a) Timely submission of disturbance recorder (DR) and event logger (EL) files need to be ensured. As per IEGC clause 37.2 (c), Disturbance Recorder (DR), station Event Logger (EL), Data Acquisition System (DAS) shall be submitted within 24 hrs of the event. b) HPPPTCL shall taken necessary actions to rectify the protection related issue in 220kV Khodri-Majri ckt-2. c) OV protection needs to be disabled in 220kV lines at the earliest. d) Over frequency and over current protection operation in units at Khodri HEP need to be reviewed. e) A/R should be made operational in Sarsawan line at the earliest. f) UJVNL shall share the CPRI audit report and details of remedial action taken within one week. g) Replacement of Units breakers need to be expedited.		UJVNL representative agreed to take all the necessary remedial actions.	UJVNL representative informed following during the meeting: • Timely submission of DR/EL & tripping reports for the tripping incidents are being ensured. • <b>Overvoltage setting in all the lines at Khodri HEP has been disabled.</b> However, 220kV Khodri-Mazri ckt-2 is in jurisdiction of HPSEBL. • Over frequency & overcurrent protection in generating units have been proposed to review. • <b>Audit report of the CPRI conducted in October 2023 has already been submitted</b> by mail. • A/R operation in Sarsawan line and replacement of Unit breakers has been proposed. Follow ups are being done with OEM. • <b>Time delay setting of Z-4 in distance protection in all the lines at Khodri has been revised from 1sec to 160msec.</b>  <i>PSC forum recommended following actions to UJVNL:</i> • expedite the implementation of bus bar protection at Khodri HEP • submit the action plans w.r.t. all the desired remedial actions at Khodri HEP • Compliance status of CPRI audit report also need to be submitted.
17	Multiple elements tripping at 400/220kV Jaisalmer(RS) Akal(RS) on 20th September 2024	<b>53 PSC:</b> RVPNL shall share the detailed analysis of the event within one week.		RVPNL representative agreed to analyse the event and share the analysis.	RVPNL representative stated that multiple elements tripping occurred during this event on operation of LBB relay. However, LBB relay is not communicating due to which DRs couldn't be extracted. Therefore, analysis of the events hasn't submitted yet. OEM has been requested to update the software of relay.  <i>PSC forum requested RVPNL to resolve the issue with the LBB relay at Akal S/s at the earliest.</i>



18	Frequent tripping of 220 KV Nanauta(UP)-Saharanpur(PG) (UP) Ckt-1 & 220 KV Sarsawan(UP)-Khodri(UK) (UP) Ckt-1:	<b>54 PSC:</b> PSC forum requested UPPTCL to ensure resolution of issue with the Main-2 relay configuration at Nanauta(UP) & Sarsawan(UP) at the earliest.				
19	Multiple elements tripping at 400/220kV Obra_B(UP) on 9th October 2024	<b>54 PSC Recommendations:</b> a)UPPTCL & Obra_B(UP) shall ensure the implementation of LBB protection at the earliest. b)GPS scheme shall be implemented at Obra_B(UP) by the <b>end of January 2025</b> and time sync of recording devices will be ensured.				
20	Multiple elements tripping at 220/132kV Obra_A(UP) on 9th October 2024	<b>54 PSC Recommendations:</b> Commissioning and Implementation of numerical relays in 132kV ICT-1&2 at Obra_A(UP) need to be expedited. Timely commissioning of the same need to be ensured.				
21	Multiple elements tripping at 400kV Muradnagar_2(UP) on 17th October 2024	<b>54 PSC Recommendations:</b> a)UPPTCL shall ensure the necessary correction in ZIV make bus bar protection at 400kV Muradnagar_2(UP) by the <b>end of December 2024</b> . b)Time synchronisation and standardisation of recording instrument need to be ensured.				
22	Multiple elements tripping at 400kV Aligarh(UP) on 23rd October 2024	<b>54 PSC Recommendations:</b> Issues related to bus bar protection at 400kV Aligarh(UP) need to be resolved at the earliest.				
23	Multiple elements tripping at 400/220kV Kashipur(Utt) on 10 <sup>th</sup> October 2024	<b>54 PSC Recommendations:</b> a)PTCUL shall review the SPS scheme at 400/220kV Kashipur S/s. b)Overcurrent protection setting (IDMT) need to be revised in line with the approved protection philosophy.				
24	Multiple elements tripping at 220kV Dausa(RS) on 21st October 2024	<b>54 PSC Recommendations:</b> a)RVPNL will expedite the replacement of all the static relays at 220kV Dausa S/s with numerical relays. b)Time synchronization of all the recording instruments need to be ensured.				
25	Multiple elements tripping at 400kV Alwar(RS) on 30th October 2024	<b>54 PSC Recommendations:</b> RVPNL shall design a suitable SPS for 400/220kV Alwar S/s a propose the same in next OCC/PSC meeting for discussion.				
26	Frequent tripping of 220 KV Auraiya(NT)-Mehgaon(MP) (MPSEB) Ckt-1	<b>54 PSC Recommendations:</b> PSC forum recommended NTPC to take necessary actions to minimise the tripping and ensure proper operation of A/R in line				

## Grid Event summary for November 2024

S.No.	Category of Grid Incident/ Disturbance	Name of Elements (Tripped/Manually opened)	Outage		Revival		Duration (hh:mm)	Event (As reported)	Loss of generation / loss of load during the Grid Disturbance		Fault Clearance time (in ms)
			Date	Time	Date	Time			Generation Loss(MW)	Load Loss (MW)	
1	GI-1	1) 220 kV Bhadla(RS)-Saurya Urja Ckt-1	1-Nov-24	12:47	1-Nov-24	15:04	02:17	i)Total generation of 220kV Saurya Urja(P) S/s is evacuated to Bhadla(RS) at 220kV level through 220 kV Bhadla(RS)-Saurya Urja D/C. ii)During antecedent condition, 220 kV Bhadla(RS)-Saurya Urja Ckt-1 & 2 were carrying approx. 245 MW and 239 MW respectively. iii)As reported at 12:47 hrs, 220 kV Bhadla(RS)-Saurya Urja Ckt-1 tripped from Bhadla(RS) end only on R-N phase to earth fault with fault current of 5kA and fault distance of 1.85km from Bhadla(RS) end; fault sensed in zone-1 from Bhadla(RS) end. Exact reason of fault cannot be identified after patrolling. Hence it seems that fault was of transient nature and there was issue in A/R operation at Bhadla(RS) end. iv)As per PMU at Bhadla(PG), 3-phase to earth fault is observed with fault clearing time of 80msec. v)As per SCADA, change in solar generation of approx. 300 MW and no change in demand are observed in Rajasthan control area.	300	0	80
2	GI-2	1) 400 KV Aligarh-Muradnagar_1 (UP) Ckt 2) 400 KV Aligarh-Shamli (UP) Ckt-1 3) 400 KV Aligarh-Shamli (UP) Ckt-2	2-Nov-24	01:51	2-Nov-24	03:23	01:32	i)400/220kV Aligarh(UP) has one and half breaker scheme at 400kV level and double main and transfer bus scheme at 220kV level. ii)As reported, at 01:51 hrs, 400 KV Aligarh-Muradnagar_1 (UP) Ckt tripped on B-N phase to earth fault with fault current of 2.912kA from Muradnagar_1 end and 18.916kA from Aligarh end; fault sensed in zone-1 at Aligarh end and zone-2 at Muradnagar_1 end. As per DR at Muradnagar_1 end, fault clearing time was ~377ms (delay in fault clearing at Muradnagar_1, carrier not received). As per DR at Aligarh end, unsuccessful A/R was observed with A/R dead time of 840 ms (less A/R dead time observed). iii)During the same time, 400 KV Aligarh-Shamli (UP) Ckt-1 & 2 also tripped on over-voltage at Aligarh end (as per EL of Main-1 at Aligarh). As per DR, R-ph voltage reached upto ~1.35 p.u. at Aligarh end of 400 KV Aligarh-Shamli (UP) Ckt-1 and B-N phase to earth fault with fault current of 642 A from Aligarh end is observed in 400 KV Aligarh-Shamli (UP) Ckt-2. Time sync issue is observed in Main-2 relay at Aligarh end of both 400 KV Aligarh-Shamli (UP) Ckt-1 & 2. As reported, DT received at Shamli end for both the lines. iv)As per PMU at Mainpuri(PG), B-N phase to earth fault with unsuccessful A/R is observed with fault clearing time of 80ms. v)As per SCADA, change in demand of approx. 130 MW is observed in UP control area.	0	130	80
3	GI-1	1) 66 MW Pong HPS - UNIT 6 2) 66 MW Pong HPS - UNIT 2 3) 220KV Bus 2 at Pong(BB) 4) 220 KV Jalandhar-Pong (BB) Ckt-2 5) 220 KV Jessore(HP)-Pong(BB) (PG) Ckt-1 6) 220 KV Pong(BB)-Dasuya(PS) (BBMB) Ckt-2	6-Nov-24	20:45	6-Nov-24	22:54	02:09	i)During antecedent condition, 66MW Unit-2, 3, 5 & 6 at Pong HEP were running and generating approx. 66MW, 66MW, 64MW and 56MW respectively (as per SCADA). 66MW Unit-1 & 4 at Pong HEP were not in service. ii)As reported, at 20:45 hrs, while stopping 66 MW Unit-6 at Pong (BB), the Relay MICOM P643- CB Head Flashover operated. As informed by the site, the Earth Fault relay connected to Unit-06 GT neutral operated, and the CB of Unit-6 opened. However, the Earth Fault current did not reduce to 0 A immediately. As a result, due to the AND operation logic (where the CB is open and the Earth Fault remains active), the CB Head Flashover was initiated, causing simultaneous tripping of 220 kV Bus-2 at Pong(BB). iii)As 220 KV Jalandhar-Pong (BB) Ckt-2, 220 KV Jessore(HP)-Pong(BB) (PG) Ckt-1, 220 KV Pong(BB)-Dasuya(PS) (BBMB) Ckt-2 and 66 MW Pong HPS - UNIT 2 were connected to 220 kV Bus-2 at Pong(BB), all these elements tripped from Pong end along with Bus-2. iv)As discussed with BBMB personnel, a delay of 15 ms is kept for reduction of earth fault current to 0 A (in case of CB open condition) in CB Head Flashover protection logic to avoid overlapping conditions. v)As per PMU at Jalandhar(PG), no fault is observed in the system. However, fluctuation in voltage is observed. vi)As per SCADA, generation loss of approx. 125 MW at Pong HEP (BB) and no load loss is observed in HP control area.	125	0	NA
4	GI-2	1) 400 KV Jawaharpur_TPS(UP) - Bus 2 2) 400/220 kv 500 MVA ICT 3 at Jawaharpur_TPS(UP) 3) 400/220 kv 500 MVA ICT 4 at Jawaharpur_TPS(UP) 4) 410 MAIN BAY - 400 KV FIROZABAD(PJFTL)-JAWAHARPUR_TPS(UP) (UP) CKT-2 (UPRVUNL) AT 400 KV JAWAHARPUR_TPS(UP) 5) 125 MVAR Bus Reactor No 1 at 400 KV Jawaharpur_TPS(UP)	11-Nov-24	15:56	11-Nov-24	21:44	05:48	i)During antecedent condition, 400 kv Firozabad-Jawaharpur Ckt 2 (28 MW) and 400/220 kv 500 MVA ICT 4 (27 MW) were connected to 400 kv Bus 2. 400 kv Firozabad-Jawaharpur Ckt 1 (26 MW), 125 MVAR bus reactor, and 400/220 kv 500 MVA ICT 3 (27 MW) were connected to 400 kv Bus 1. The 765/400 kv ICT 1 and 2 were not in service at that point of time. ii)As reported at 15:56:14:463 hrs, R-N fault occurred at TEED portion of bay 401 & 402. On this fault, bus bar protection of 400KV Bus-2 at 400 KV JAWAHARPUR_TPS(UP) operated. This led to tripping of breakers 410, 407 & 401 bay connected to 400KV Bus 2. At the same time (with the gap of 20msec), TEED protection operated which tripped Bay 402 (Tie Bay of 400/220KV ICT 3 & 4). This led to tripping of 400/220KV ICT 4. Further after ~30msec, 400KV Bay No 403 breaker opened led to the tripping 400/220 KV ICT 3 at Jawaharpur(UP). Exact reason of operation of bus bar protection along with TEED protection is yet to be received from UP. DR/EL of the tripping events also yet to be received. iii)After further 60msec, 125 MVAR Bus Reactor No 1 at 400 KV Jawaharpur_TPS(UP) also tripped on back up impedance protection operation. DR of the tripping is yet to be received. iv)As per PMU at Mainpuri (PG), R-N fault which cleared within 100msec is observed. v)As per SCADA, no load loss is observed in UP control area.	0	0	80
5	GI-2	1) 220KV BUS1&2 AT MERTA(RS) 2) 400/220 kv 315 MVA ICT 1 AT MERTA(RS) 3) 400/220 kv 315 MVA ICT 2 AT MERTA(RS) 4) 220KV MERTA-BHOPALGARH (RS) CKT 5) 220KV MERTA-KUCHERA (RS) CKT 6) 220/132 kv 100 MVA ICT 1 AT MERTA(RS) 7) 220/132 kv 100 MVA ICT 2 AT MERTA(RS) 8) 220/132 kv 100 MVA ICT 3 AT MERTA(RS) 9) 220KV MERTA-JETHANA(RS) CKT	11-Nov-24	12:22	11-Nov-24	23:55	11:33	i)During antecedent condition, loading of 400/220 kv 315 MVA ICT 1 & 2 and 220/132kv 100MVA ICT-1, 2 & 3 at Merta(RS) were 171 MW, 177 MW, 62 MW and 56 MW respectively as per SCADA. 220kV Merta(RS)-Makrana(RS) Ckt was not in service. ii)As reported, at 12:22hrs, R-phase jumper of 220 kv Merta-Jethana snapped, and this broken jumper conductor fell on both 220 kv Bus-A and Bus-B at Merta. Because of this, Bus Bar protection operated at 400/220/132kv Merta S/s. iii)As a result, both 220KV Bus 1 & 2, along with all the elements connected to them i.e., 400/220 ICT-1 & 2, 220KV MERTA-JETHANA(RS), 220KV MERTA-BHOPALGARH (RS), 220KV MERTA-KUCHERA (RS), 220/132 kv 100 MVA ICT 1, ICT 2 & ICT 3 AT MERTA(RS) tripped. iv)As per PMU at Merta(RS), R-Y-B fault is observed with delayed fault clearance time of 720 msec. v)As per SCADA, change in demand of approx. 635 MW is observed in Rajasthan control area.	0	635	720
6	GI-1	1) 125 MVAR BUS REACTOR NO 1 AT 400KV HINDAUN(RS) 2) 400 KV Heerapura-Hindaun (RS) CKT-1 3) 400 KV Hindaun(RS)-Chhabra(RVUN) (RS) Ckt 4) 400 KV Alwar(ATIL)-Hindaun(RS) (ATIL) Ckt	16-Nov-24	05:21	16-Nov-24	07:23	02:02	i)As reported, at 05:21hrs, interrupter of CB Pole (R-Ph.) blasted at the time of opening of CB of 125MVAR Bus Reactor at Hindaun (RS) on voltage regulation. ii)During the same time, 400 KV Hindaun(RS)-Chhabra(RVUN) (RS) Ckt, 400 KV Heerapura-Hindaun (RS) Ckt, and 400 KV Alwar(ATIL)-Hindaun(RS) (ATIL) Ckt at Hindaun(Raj) also tripped (exact reason of tripping yet to be shared). iii)As per DR of 400 KV Hindaun(RS)-Chhabra(RVUN) (end) (RS) Ckt, zone-2 distance protection operated at Chhabra end. R-N phase to earth fault was observed with fault current of 1.676kA and delayed fault clearance time of ~350ms. (DR nomenclature & time sync issue in DR need to be corrected). iv)As per PMU at Heerapura (RS) and DR of Chhabra end, R-N fault is observed with delayed fault clearance time of 360 ms. v)As per SCADA, load loss of approx. 325 MW in Rajasthan control area was observed.	0	325	360
7	GI-1	1) 132 KV HAMIRPUR-II (Mattansidh)(HPSEBL)-Kangoo(HPSEBL) 1 2) 132 KV HAMIRPUR-II (Mattansidh)(HPSEBL)-KANGOO(HPSEBL) 2	21-Nov-24	08:42	21-Nov-24	08:57	00:15	i)220/132 kv Hamitpur-II(HP) substation has double Bus scheme in both 220KV and 132KV system. It has 3 (three) 220/132 kv ICTs along with 2 circuits connecting to 220KV Hamirpur (PG) and in 132 KV Hamirpur I – Hamirpur-II Ckt1 & 2, 132 KV Hamirpur II – Kangoo Ckt.1 & 2 and 132KV Hamirpur-II – Dehra I & II. ii)As reported at 08:42hrs, 132 kv Hamirpur II – Kangoo Ckt-1 & 2 tripped (exact reason of tripping yet to be shared). iii)Also SCADA data for 132 kv Hamirpur II – Kangoo Ckt-1 & 2 wasn't available before or after the tripping incident. iv)As per PMU at Hamirpur (PG) end, no fault was observed. v)As per SCADA, a change in demand of approx. 155 MW is observed in Himachal Pradesh control area.	0	155	NA

S.No.	Category of Grid Incident/ Disturbance	Name of Elements (Tripped/Manually opened)	Outage		Revival		Duration (ht:mm)	Event (As reported)	Loss of generation / loss of load during the Grid Disturbance		Fault Clearance time (in ms)
			Date	Time	Date	Time			Generation Loss(MW)	Load Loss (MW)	
8	GI-2	1) 400 KV Bhadla-Merta (RS) Ckt-1 2) 400 KV Bikaner-Bhadla (RS) Ckt-1 3) 400 KV Bikaner-Bhadla (RS) Ckt-2	23-Nov-24	22:11	24-Nov-24	00:02	01:51	i)During antecedent condition, 400 KV Bhadla-Merta (RS) Ckt-1, 400 KV Bikaner-Bhadla (RS) Ckt-1 and 400 KV Bikaner-Bhadla (RS) Ckt-2 were connected to 400KV Bus-1 and were carrying 13MW, 86MW and 87MW of load respectively. ii)As reported at 22:11hrs, 400 KV Bhadla-Merta (RS) Ckt-1 tripped on R-N fault. At the same time, 400 KV Bikaner-Bhadla (RS) Ckt-1 and 400 KV Bikaner-Bhadla (RS) Ckt-2 also tripped. 400 KV Bikaner-Bhadla (RS) Ckt-2 tripped due to DT received from Bhadla end. (Exact reason of fault, DT received from Bhadla end and tripping of 400 KV Bikaner-Bhadla (RS) Ckt-2 yet to be shared). iii)As per DR of 400 KV Bikaner-Bhadla (RS) Ckt-2, Bikaner (end), the circuit tripped at due to DT received at Bikaner end from Bhadla. (DR nomenclature & time sync issue in DR need to be corrected.) iv)As per PMU at Bikaner (PG) and DR of Bikaner (RS) end, R-N fault is observed which cleared within 100 ms. v)As per SCADA, no change in demand is observed in Rajasthan control area.	0	0	80
9	GI-1	1) 220 KV Amargarh (INDIGRID)-Ziankote(JK) (PDD JK) Ckt-1 2) 220 KV Amargarh (INDIGRID)-Ziankote(JK) (PDD JK) Ckt-2	26-Nov-24	14:13	26-Nov-24	15:20	01:07	i)220/132kV Ziankote S/s have two bus at 220kV side i.e., main bus & reserve bus. 220kV Amargarh-Ziankote ckt-1&2 are on the same tower (D/C tower) and line length is ~21.4km. ii)During antecedent condition, 220kV Amargarh (INDIGRID) –Ziankote(JK) D/C was carrying 138 MW each and feeding Ziankote load. iii)As reported, at 14:13 hrs, 220 KV Amargarh (INDIGRID)-Ziankote(JK) (PDD JK) Ckt-1 tripped on B-N phase to earth fault with fault distance of 22.34 km (as per EL) and fault current of Ib=~2.81kA (as per DR) from Amargarh end. Fault sensed in zone-2 at Amargarh end. iv)During the same time, 220 KV Amargarh (INDIGRID)-Ziankote(JK) (PDD JK) Ckt-2 also tripped on B-N phase to earth fault with fault distance of 27.46km (as per EL) and fault current of Ib=~3.43kA (as per DR) from Amargarh end. Fault sensed in zone-2 at Amargarh end. v)As confirmed by Amargarh (INDIGRID), in view of non-availability of carrier communication and A/R scheme at Ziankote end, A/R has been kept disabled at Amargarh end and time delay of Z-2 was also kept as instantaneous at Amargarh end. vi)As per PMU at Amargarh (PG), B-N phase to earth fault which cleared within 80 msec is observed. vii)As per SCADA, change in demand of approx. 260 MW is observed in J&K control area.	0	260	80
10	GD-1	1) 400 KV Dulhasti(NH)-Kishenpur(PG) (PG) Ckt-1 2) 130MW Unit-2 at Dulhasti HEP	27-Nov-24	14:50	27-Nov-24	15:33	00:43	i)During antecedent condition, 130MW Unit-2 at Dulhasti HEP were running generating approx. 110 MW and total generated power of 110MW was evacuating through 400 KV Dulhasti(NH)-Kishenpur(PG) (PG) Ckt-1 only. 130MW Unit-1 & 3 at Dulhasti HEP and 400 kV Dulhasti(NH)-Kishenpur(PG) (PG) Ckt-2 were not in service. ii)As reported, at 14:50hrs, 400 KV Dulhasti(NH)-Kishenpur(PG) (PG) Ckt-1 tripped on Y-N phase to earth fault (Exact reason, location and nature of fault along with DR/EL yet to be shared). As per PMU, unsuccessful A/R is observed with fault current of ~2.025kA followed by ~2.282kA from Kishenpur(PG) end. iii)Due to tripping of 400 KV Dulhasti(NH)-Kishenpur(PG) (PG) Ckt-1, 130MW Unit-2 at Dulhasti HEP tripped due to loss of evacuation path on over-speed protection operation. iv)As per PMU at Kishenpur (PG), Y-N phase to earth fault with unsuccessful A/R is observed with fault clearing time of 80ms. v)As per SCADA, generation loss of approx. 110MW is observed at Dulhasti HEP.	110	0	80

Sr No	Element Name	Outage Date	Outage Time	Reason
1	220 KV RAPS_A(NP)-Sakatpura(RS) (RS) Ckt-1	01-Nov-24	04:34	Phase to earth fault R-N. no auto-reclosing is observed
		02-Nov-24	18:01	Phase to earth fault R-N. No auto-reclosing is observed
		12-Nov-24	00:01	Phase to earth fault R-N. No auto-reclosing is observed
		19-Nov-24	05:51	Phase to earth fault R-N. No auto-reclosing is observed
		20-Nov-24	03:40	Phase to earth fault R-N. No file received.
2	220 KV RAPS_A(NP)-Sakatpura(RS) (RS) Ckt-2	08-Nov-24	19:32	Phase to earth fault R-N. No file received.
		10-Nov-24	23:19	Phase to earth fault R-N. No file received.
		16-Nov-24	22:24	Phase to earth fault R-N. No auto-reclosing is observed
		19-Nov-24	02:23	Phase to earth fault R-N. No auto-reclosing is observed
3	400 KV Agra-Unnao (UP) Ckt-1	08-Nov-24	14:34	Phase to earth fault Y-N.As per PMU, no fault is observed.
		17-Nov-24	13:26	Line tripped due to Direct trip due to tripping at Unnao end for line shifting to work on Bus-1.
		20-Nov-24	13:49	Phase to earth fault B-N. As per PMU, 2 successive B-N faults observed in 8 secs apart.
4	400 KV Aligarh-Shamli (UP) Ckt-2	30-Nov-24	11:34	Phase to earth fault R-N with unsuccessful auto-reclosing observed along with Oscillations.
		02-Nov-24	01:51	Phase to Phase Fault Y-B.
		14-Nov-24	01:10	Phase to Ground Fault R-N. Unsuccessful auto-reclosing with delayed clearance of 1.52s
		26-Nov-24	11:53	Phase to earth fault Y-N. As per PMU, Y-N fault occurred, no auto-reclosing is observed.
5	400 KV Aligarh-Sikandrabad (UP) Ckt-1	01-Nov-24	20:42	Phase to earth fault B-N. As per PMU, B-N fault occurred, no auto-reclosing is observed.
		14-Nov-24	01:20	Phase to Ground Fault R-N. Unsuccessful auto-reclosing with delayed clearance of 1s
		18-Nov-24	02:55	Phase to earth fault R-N with Unsuccessful auto-reclosing
6	400 KV Amritsar(PG)-Makhu(PS) (PSTCL) Ckt-1	10-Nov-24	07:39	Phase to earth fault Y-N with Unsuccessful auto-reclosing
		15-Nov-24	09:43	Phase to Ground Fault R-N. As per PMU, no fault is observed.
		24-Nov-24	12:46	Phase to earth fault Y-N with Unsuccessful auto-reclosing
7	400 KV Anpara_B(UPUN)-Mau(UP) (UP) Ckt-1	27-Nov-24	06:12	Phase to earth fault Y-N with Unsuccessful auto-reclosing
		22-Nov-24	13:05	Phase to earth fault B-N with Unsuccessful auto-reclosing with delayed clearance of 240msec
		29-Nov-24	12:25	Phase to earth fault B-N with Unsuccessful auto-reclosing with delayed clearance of 200msec
8	400 KV Bareilly-Unnao (UP) Ckt-1	21-Nov-24	01:31	Phase to earth fault B-N with Unsuccessful auto-reclosing
		21-Nov-24	06:13	Phase to earth fault R-N. As per PMU, R-N fault occurred, no auto-reclosing is observed.
		25-Nov-24	14:24	Phase to earth fault R-N. As per PMU no fault is observed
9	400 KV Talwandi Saboo(PSG)-Nakodar(PSG) (PS) Ckt-1	27-Nov-24	04:04	Phase to earth fault R-N. As per PMU, R-N fault occurred, no auto-reclosing is observed.
		12-Nov-24	04:35	Phase to earth fault B-N. As per PMU, B-N fault occurred, no auto-reclosing is observed.
		14-Nov-24	07:29	Phase to earth fault R-N with Unsuccessful auto-reclosing
		14-Nov-24	23:47	Phase to earth fault R-N with Unsuccessful auto-reclosing

Grid Event to be discussed in 55th PSC Meeting

S.No.	Category of Grid Incident/ Disturbance  (GI-I to GD-V)	Name of Elements (Tripped/Manually opened)	Affected Area	Owner/ Agency	Outage		Event (As reported)	Loss of generation / loss of load during the Grid Disturbance		Fault Clearance time (in ms)	Points of discussion
					Date	Time		Generation Loss(MW)	Load Loss (MW)		
1	GI-2	1) 400 KV Aligarh-Muradnagar_1 (UP) Ckt 2) 400 KV Aligarh-Shamli (UP) Ckt-1 3) 400 KV Aligarh-Shamli (UP) Ckt-2	Uttar Pradesh	UPPTCL	2-Nov-24	01:51	i)Generation of 220/220KV KSRPL F103 station evacuates through 220 KV Fatehgarh(H) (PG)-KSRPL_Lydy_F103_PG (RENEW SURYA ROSHNI PRIVATE LIMITED) Ckt. During antecedent condition, 1400/220KV Aligarh(UP) has one and half breaker scheme at 400KV level and double main and transfer bus scheme at 220KV level. ii)As reported, at 01:51 hrs, 400 KV Aligarh-Muradnagar_1 (UP) Ckt tripped on B-N phase to earth fault with fault current of 2.912kA from Muradnagar_1 end and 18.916kA from Aligarh end; fault sensed in zone-1 at Aligarh end and zone-2 at Muradnagar_1 end. As per DR at Muradnagar_1 end, fault clearing time was ~377ms (delay in fault clearing at Muradnagar_1, carrier not received). As per DR at Aligarh end, unsuccessful A/R was observed with A/R dead time of 840 ms (less A/R dead time observed). iii)During the same time, 400 KV Aligarh-Shamli (UP) Ckt-1 & 2 also tripped on over-voltage at Aligarh end (as per EL of Main-1 at Aligarh). As per DR, R-phase voltage reached upto ~1.35 p.u. at Aligarh end of 400 KV Aligarh-Shamli (UP) Ckt-1 and B-N phase to earth fault with fault current of 62.2 A from Aligarh end is observed in 400 KV Aligarh-Shamli (UP) Ckt-2. Time sync issue is observed in Main-2 relay at Aligarh end of both 400 KV Aligarh-Shamli (UP) Ckt-1 & 2. As reported, DT received at Shamli end for both the lines. iv)As per PMU at Mainpur(PG), B-N phase to earth fault with unsuccessful A/R is observed with fault clearing time of 80ms. v)As per SCADA, change in demand of approx. 130 MW is observed in UP control area.	0	130	80	Details analysis of the event and remedial action taken details.
2	GI-1	1) 66 MW Pong HPS - UNIT 6 2) 66 MW Pong HPS - UNIT 2 3) 220KV Bus 2 at Pong(BB) 4) 220 KV Jalandhar-Pong (BB) Ckt-1 5) 220 KV Jessore(HP)-Pong(BB) (PG) Ckt-1 6) 220 KV Pong(BB)-Dasuya(PS) (BBMB) Ckt-2	Himachal Pradesh	BBMB, HPPTCL, PSTCL, PGCL	6-Nov-24	20:45	i)During antecedent condition, 66MW Unit-2, 3, 5 & 6 at Pong HEP were running and generating approx. 66MW, 66MW, 64MW and 56MW respectively (as per SCADA). 66MW Unit-1 & 4 at Pong HEP were not in service. ii)As reported, at 20:45 hrs, while stopping 66 MW Unit-6 at Pong (BB), the Relay MICOM P643- CB Head Flashover operated. As informed by the site, the Earth Fault relay connected to Unit-06 GT neutral operated, and the CB of Unit-6 opened. However, the Earth Fault current did not reduce to 0 A immediately. As a result, due to the AND operation logic (where the CB is open and the Earth Fault remains active), the CB Head Flashover was initiated, causing simultaneous tripping of 220 KV Bus-2 at Pong(BB). iii)As 220 KV Jalandhar-Pong (BB) Ckt-2, 220 KV Jessore(HP)-Pong(BB) (PG) Ckt-1, 220 KV Pong(BB)-Dasuya(PS) (BBMB) Ckt-2 and 66 MW Pong HPS - UNIT 2 were connected to 220 KV Bus-2 at Pong(BB), all these elements tripped from Pong end along with Bus-2. iv)As discussed with BBMB personnel, a delay of 15 ms is kept for reduction of earth fault current to 0 A (in case of CB open condition) in CB Head Flashover protection logic to avoid overlapping conditions. v)As per PMU at Jalandhar(PG), no fault is observed in the system. However, fluctuation in voltage is observed. vi)As per SCADA, generation loss of approx. 125 MW at Pong HEP (BB) and no load loss is observed in HP control area.	125	0	NA	Details analysis of the event and remedial action taken details.
3	GI-2	1) 400 KV Jawaharpur_TPS(UP) - Bus 2 2) 400/220 KV 500 MVA ICT 3 at Jawaharpur_TPS(UP) 3) 400/220 KV 500 MVA ICT 4 at Jawaharpur_TPS(UP) 4) 410 MAIN BAY - 400 KV FIROZABAD(PJ/F/L)-JAWAHARPUR_TPS(UP) (UP) Ckt-2 (UPRVUNL) AT 400 KV JAWAHARPUR_TPS(UP) 5) 125 MVAR Bus Reactor No 1 at 400 KV Jawaharpur_TPS(UP)	Uttar Pradesh	UPPTCL	11-Nov-24	15:56	i)During antecedent condition, 400 KV Firozabad-Jawaharpur Ckt 2 (28 MW) and 400/220 kv 500 MVA ICT 4 (27 MW) were connected to 400 KV Bus 2, 400 KV Firozabad-Jawaharpur Ckt 1 (26 MW), 125 MVAR bus reactor, and 400/220 kv 500 MVA ICT 3 (27 MW) were connected to 400 KV Bus 1. The 765/400 KV ICT 1 and 2 were not in service at that point of time. ii)As reported at 15:56:14:463 hrs, R-N fault occurred at TEED portion of bay 401 & 402. On this fault, bus bar protection of 400KV Bus-2 at 400 KV JAWAHARPUR_TPS(UP) operated. This led to tripping of breakers 410, 407 & 401 bay connected to 400KV Bus 2. At the same time (with the gap of 20msec), TEED protection operated which tripped Bay 402 (The Bay of 400/220KV ICT 3 & 4). This led to tripping of 400/220KV ICT 4. Further after ~30msec, 400KV Bay No 403 breaker opened led to the tripping 400/220 KV ICT 3 at Jawaharpur(UP). Exact reason of operation of bus bar protection along with TEED protection is yet to be received from UP. DR/EL of the tripping events also yet to be received. iii)After further 60msec, 125 MVAR Bus Reactor No 1 at 400 KV Jawaharpur_TPS(UP) also tripped on back up impedance protection operation. DR of the tripping is yet to be received. iv)As per PMU at Mainpur (PG), R-N fault which cleared within 100msec is observed. v)As per SCADA, no load loss is observed in UP control area.	0	0	80	Details analysis of the event and remedial action taken details.
4	GI-2	1) 220KV BUS1&2 AT MERTA(RS) 2) 400/220 KV 315 MVA ICT 1 AT MERTA(RS) 3) 400/220 KV 315 MVA ICT 2 AT MERTA(RS) 4) 220KV MERTA-BHOPALGARH (RS) Ckt 5) 220KV MERTA-KUCHERA (RS) Ckt 6) 220/132 KV 100 MVA ICT 1 AT MERTA(RS) 7) 220/132 KV 100 MVA ICT 2 AT MERTA(RS) 8) 220/132 KV 100 MVA ICT 3 AT MERTA(RS) 9) 220KV MERTA-JETHANA(RS) Ckt	Rajasthan	RVPNL	11-Nov-24	12:22	i)During antecedent condition, loading of 400/220 kv 315 MVA ICT 1 & 2 and 220/132kv 100MVA ICT-1, 2 & 3 at Merta(RS) were 171 MW, 177 MW, 62 MW, 62 MW and 56 MW respectively as per SCADA. 220kv Merta(RS)-Makrana(RS) Ckt was not in service. ii)As reported, at 12:22hrs, R-phase jumper of 220 KV Merta-Jethana snapped, and this broken jumper conductor fell on both 220 kv Bus-A and Bus-B at Merta. Because of this, Bus Bar protection operated at 400/220/132kv Merta S/S. iii)As a result, both 220KV Bus 2 & 1, along with all the elements connected to them i.e., 400/220 ICT-1 & 2, 220KV MERTA-JETHANA(RS), 220KV MERTA-BHOPALGARH (RS), 220KV MERTA-KUCHERA (RS), 220/132 KV 100 MVA ICT 1, ICT 2 & ICT 3 AT MERTA(RS) tripped. iv)As per PMU at Merta(RS), R-Y-B fault is observed with delayed fault clearance time of 720 msec. v)As per SCADA, change in demand of approx. 635 MW is observed in Rajasthan control area.	0	635	720	Details of protection operation details at Ziankotye(B&K) end.
5	GI-1	1) 125 MVAR BUS REACTOR NO 1 AT 400KV HINDAUN(RS) 2) 400 KV Heerapura-Hindaun (RS) Ckt-1 3) 400 KV Hindaun(RS)-Chhabra(RVUNL) (RS) Ckt 4) 400 KV Alwar(ATIL)-Hindaun(RS) (ATIL) Ckt	Rajasthan	RVPNL, RVUNL, ATIL	16-Nov-24	05:21	i)As reported, at 05:21 hrs, interrupter of CB Pole (R-Ph.) blasted at the time of opening of CB of 125MVAR Bus Reactor at Hindaun (RS) on voltage regulation. ii)During the same time, 400 KV Hindaun(RS)-Chhabra(RVUNL) (RS) Ckt, 400 KV Heerapura-Hindaun (RS) Ckt, and 400 KV Alwar(ATIL)-Hindaun(RS) (ATIL) Ckt at Hindaun(Raj) also tripped (exact reason of tripping yet to be shared). iii)As per DR of 400 KV Hindaun(RS)-Chhabra(RVUNL) (end) (RS) Ckt, zone-2 distance protection operated at Chhabra end. R-N phase to earth fault was observed with fault current of 1.676kA and delayed fault clearance time of ~350ms. (DR nomenclature & time sync issue in DR need to be corrected.) iv)As per PMU at Heerapura (RS) and DR of Chhabra end, R-N fault is observed with delayed fault clearance time of 360 ms. v)As per SCADA, load loss of approx. 325 MW in Rajasthan control area was observed.	0	325	360	Details of protection operation details at Pampore(B&K) end.
6	GI-2	1) 400 KV Bhadla-Merta (RS) Ckt-1 2) 400 KV Bikaner-Bhadla (RS) Ckt-1 3) 400 KV Bikaner-Bhadla (RS) Ckt-2	Rajasthan	RVPNL	23-Nov-24	22:11	i)During antecedent condition, 400 KV Bhadla-Merta (RS) Ckt-1, 400 KV Bikaner-Bhadla (RS) Ckt-1 and 400 KV Bikaner-Bhadla (RS) Ckt-2 were connected to 400KV Bus-1 and were carrying 13MW, 86MW and 87MW of load respectively. ii)As reported at 22:11hrs, 400 KV Bhadla-Merta (RS) Ckt-1 tripped on R-N fault. At the same time, 400 KV Bikaner-Bhadla (RS) Ckt-1 and 400 KV Bikaner-Bhadla (RS) Ckt-2 also tripped. 400 KV Bikaner-Bhadla (RS) Ckt-2 tripped due to DT received from Bhadla end. (Exact reason of fault, DT received from Bhadla end and tripping of 400 KV Bikaner-Bhadla (RS) Ckt-2 yet to be shared). iii)As per DR of 400 KV Bikaner-Bhadla (RS) Ckt-2, Bikaner (end), the circuit tripped at due to DT received at Bikaner end from Bhadla. (DR nomenclature & time sync issue in DR need to be corrected.) iv)As per PMU at Bikaner (PG) and DR of Bikaner (RS) end, R-N fault is observed which cleared within 100 ms. v)As per SCADA, no change in demand is observed in Rajasthan control area.	0	0	80	Details analysis of the event and remedial action taken details.



S. No.	Name of Transmission Element Tripped	Owner/ Utility	Outage		Load Loss/ Gen. Loss	Brief Reason (As reported)	Category as per CEA Grid standards	# Fault Clearance Time (>100 ms for 400 kV and 160 ms for 220 kV)	*FIR Furnished (YES/NO)	DR/EL provided in 24 hrs (YES/NO)	Other Protection Issues and Non Compliance (Inference from PMU, utility details)	Suggestive Remedial Measures	Remarks
			Date	Time									
1	220 KV Auraiya(NT)-Malanpur(MP) (PG) Ckt-1	POWERGRID	03-Nov-24	04:36	Nil	Phase to Ground Fault R-N	NA	120	NO	YES (After 24 hrs)	No A/R operation		As per PMU, two successive R-N faults withtge gap of ~500msec with no A/R operation is observed .
2	400 KV RAPS_D(NP)-Shujalpur(PG) (RTCL) Ckt-2	POWERGRID	10-Nov-24	11:46	Nil	Snapping of Jumper	NA	NA	NO	NO	NA		As per PMU, no fault was observed .
3	800 KV HVDC Kurukshetra(PG) Pole-03	POWERGRID	15-Nov-24	18:09	Nil	Tripped due to control mal-operation at Champa end.	NA	NA	YES	YES	NA		As per PMU, no fault was observed, fluctuationin voltage is observed.
4	220 KV Auraiya(NT)-Malanpur(MP) (PG) Ckt-1	POWERGRID	20-Nov-24	13:11	Nil	Phase to earth fault R-N	NA	560	NO	YES	Delayed clearance of fault and no A/R operation		As per PMU, B-N fault at 13:08 hrs with delayed clearance of 560 msec, followed by R-N fault is observed
5	500 KV HVDC Mahindergarh(APL)-Adani Mundra(APL) (ATIL) Ckt-2	APL	27-Nov-24	12:32	Nil	Tripped due to TDM Bus fault at Mundra.	NA	NA	YES	YES	NA		As per PMU, no fault was observed .

# Fault Clearance time has been computed using PMU Data from nearest node available and/or DR provided by respective utilities (Annexure- II)

\*Yes, if written Preliminary report furnished by constituent(s)

R-Y-B phase sequencing (Red, Yellow, Blue) is used in the list content.All information is as per Northern Region unless specified.

^^ tripping seems to be in order as per PMU data, reported information. However, further details may be awaited.

Reporting of Violation of Regulation for various issues for above tripping

1	Fault Clearance time(>100ms for 400kV and >160ms for 220kV)	1. CEA Grid Standard-3.e 2. CEA Transmission Planning Criteria
2	DR/EL Not provided in 24hrs	1. IEGC 37.2(c) 2. CEA Grid Standard 15.3
3	FIR Not Furnished	1. IEGC 37.2(b) 2. CEA Grid Standard 12.2 (Applicable for SLDC, ALDC only)
4	Protection System Mal/Non Operation	1. CEA Technical Standard of Electrical Plants and Electric Lines: 43.4.A 2. CEA (Technical Standards for connectivity to the Grid) Regulation, 2007: Schedule Part 1. (6.1, 6.2, 6.3)
5	A/R non operation	1. CEA Technical Standard of Electrical Plants and Electric Lines: 43.4.C 2. CEA Technical Planning Criteria

Status of Bus bar protection				
Constituent Name	Name of Station	Status of Bus bar protection(as reported)	Expected date of implementation (as reported in 51st PSC meeting)	Remarks
Uttarakhand	220 KV Substation, Ramnagar, Roorkee	Blocked due to more elements added at 220 KV Voltage level.		
	220 KV Sub Station, SIDCUL, Haridwar			
	220kv Jhajhra, Dehradun	Not commissioned yet		
	400KV Kashipur (220kv side)	Available but Non operational	Revised date not received	Work is under process.
	220kv Haldwani	Not Available	31 December 2024	Budget for FY 2023-24.
	220kv Pantnagar	Available but Non operational	Revised date not received	Work is under process.
	220KV Rishikesh	Available but Non operational	31 December 2024	It has been Taken in Budget for FY 2023-24.
	220kv Chamba	Not commissioned yet	31 December 2024	It has been Taken in Budget for FY 2023-24.
Haryana	220kv S/Stn Badshahpur	Installed and Operational		Commissioned on 20.02.2023
	220kv S/Stn Sec-52A, Gurgaon	Not Installed	31.12.2024	Panel has been installed. Commissioning pending due to non-availability of shutdown.
	220kv S/Stn Sec-1 Manesar	Installed and Operational		Commissioned on 26.02.2023
	220kv S/Stn Panchgaon	Installed and Operational		Commissioned on 05.01.2024
	220kv S/Stn Rewari	Not Installed	31.03.2025	Material is not allocated so far. Installation will be carried out after allocation of material.
	220kv S/Stn Narnaul	Not Installed	31.12.2024	Panel has been installed. Work in progress on turnkey basis. Isolators of 220 kV TFs have to be replaced thereafter the work shall be completed.
	220kv S/Stn Mohinder Garh	Installed and Operational		Commissioned on 28.10.2023
	220 KV S/Stn Palwal	Not Installed	31.12.2024	Panel has been installed. Commissioning is pending.
	220 KV S/Stn Rangala Rajpur	Installed and Operational		Commissioned on 22.06.2023
	220 kV Unisapur	Installed but Non-Operational	31.10.2024	5 Nos. Peripheral relay of bus bar protection are defective. The same shall be made operational by 31.03.2024.
	220 kV Nissing	Installed but Non-Operational	31.10.2024	Existing Bus bar panel is of old and obsolete design. New Bus Bar protection scheme panel has been drawn from the store & Commissioning& installation are pending. The same shall be made operational by 31.03.2024.
	220KV Pehowa	Installed but Non-Operational	31.03.2025	Old & Obsolete, Allocation of New BBP and allied material awaited.
	220kv Kaithal	Not Installed	31.03.2025	Control Cable for Bus-Bar Protection Scheme has been drawn from DD Stores, 220KV Bus-Bar Protection panel is awaited.
	220 KV Sonapat	Not Installed	31.10.2024	220 KV Bus Bar Protection Scheme will be installed / commissioned within 45 days after the availability of the necessary material i.e 220KV Duplex, Directional, Bus Bar Cum Bus Coupler C and R Panel, Auxiliary Voltage 220V DC (without SAS) required for commissioning. It has been gathered from the P&M wing that the material is likely to be available in DD stores by April 2024.
	220 KV REGC, Sonapat	Not Installed	30.09.2024	The 220KV C&R Panel for Bus Bar Protection has been drawn from DD Store on dated 20.04.2023 and the work for installation of Bus Bar protection scheme is under progress. Erection work & wiring work completed with all respect. Testing of relays is pending at the end of Firm M/s Shifang and Bus Bar protection scheme will be commissioned dt 15.03.2024.
	220KV Jind	Installed and Operational		Commissioned on dated 27.06.23.
	220 KV Fatehabad	Installed and Operational		Commissioned on dated 22.07.23
	220 KV Hukmawali	Installed but Non-Operational	30.10.2023	Bus-coupler CB defective & new panel withdrawn from DD store. Erection work under progress & the same will be completed 31.08.23.
	220 KV Bhuna	Installed but Non-Operational	31.12.2024	The Siemens make Bus Bar protection Scheme installed at the time of commissioning of the substation went out of order. The higher authority decided to replace with new one. M/s Schneider make new Scheme was then allocated and drawn from DDS Ballabgarh and installed at site, but while testing of same, three out of four relays of the Bus Bar Panel found faulty for which matter is under pursuance with firm.
	220 KV Sirsa	Not Installed		Not required being single source of supply
	220 KV Rania	Not Installed	31.03.2025	Estimate for Bus Bar Protection is sanctioned but C&R panel is not available in store.
	220 KV Bhiwani	Not Installed	31.03.2025	Bus Bar Protection scheme has been proposed in integrated planning meeting and requirement of material have been generated in PR.
	220kv Madanpur	Not Installed	30.11.2024	Material is not allocated so far. Installation will be carried out after allocation of material.
	220kv Tepla	Installed but Non-Operational	30.11.2024	material allocation is awaited.
220kv Rajokheri	Installed and Operational		Made operational on dated 30.05.2024.	
BBMB	220kv Charkhi Dadri	Installed and Operational		commissioned on 31.01.2023
	220kv Samaypur	Installed and Operational		made operational on 23.12.2023
	220kv Dhulkote	Not Installed		Not feasible
	220kv Jagadhari	Not Installed		
	220kv Barnala	Not Installed		
	220kv Parichha	Installed but Non-Operational	Revised date not received	
	220kv Partapur	Installed and Operational		made operational on 06.01.2023
	220kv Bareilly (400/220kv Bareilly)	Installed but Non-Operational	Revised date not received	Old panel capacity exhausted. New relay panel supplied & need to be
	220kv Pilibhit	Installed and Operational		commissioned on 28.10.2023
	220kv Amariya	Installed and Operational		commissioned on 15th July 2023
	220kv Sultanpur	Installed and Operational		commissioned on 02.03.2024



UP	220kV New Tanda	Installed and Operational		commissioned on 20.04.2024
	220kV Shahjhanpur	Installed but Non-Operational	Revised date not received	Cable partially received, work will start soon
	220kV Aijlpur	Installed but Non-Operational		1. HV side 220kV CT of 160MVA T/F-I & II has bot proper ratio for bus bar
	220kV Nirpura	Installed but Non-Operational	Revised date not received	
	220kV IITGNL	Installed and Operational		made operational on 19.02.2023
	220kV Rampur	Installed but Non-Operational	Revised date not received	
	220kV Barahua	Installed and Operational		made operational on 28.01.2024
	220kV Bansi	Installed and Operational		commissioned on 10th August 2023
	220 KV S/S Azamgarh-2(Bargahan)	Installed and Operational		made operational on 28.01.2024
	220kV Chandausi	Installed and Operational		made operational on 13.10.2023
	220kV Rasara	Not Installed		
	220kV Rampur	Installed but Non-Operational	31.10.2024	Central unit of bus bar protection faulty. Expected to revive by November-24.
	220kV Sec. - 148, Noida	Installed and Operational		made operational on 27.01.2024
	220kV sec. 38A, Botanicla Garden	Not Installed	31.11.2024	Bus Bar protection panel awaited
	220kV sec.-62, Noida	Installed and Operational		made operational on 12.10.2023
	220kV Dadri	Installed and Operational		made operational on 23.04.2024
	400kV S/S Agra	Installed and Operational		commissioned on 13th September 2023
	220kV S/S Bah	Not Installed		Requirement sent to design circle, awaited fro allotment.
	220kV Sirsaganj	Not Installed		Requirement sent to design circle, awaited fro allotment.
	220kV S/S Farrukhabad (New)	Installed and Operational		commissioned on 25th August 2023
	220kV Boner	Installed and Operational		commissioned on 19.03.2024
	220kV Kasganj (Soron)	Installed and Operational		
	220kV Khair	Installed but Non-Operational	Revised date not received	New 160MVA transformer-3 is not configured with bus bar
	220kV Kidwainagar	Installed but Non-Operational		
	220kV Chhata	Installed but Non-Operational	Revised date not received	New 160MVA transformer-3 is not configured with bus bar
	220kV Harduaganj	Installed but Non-Operational	Revised date not received	
	220kV Lalitpur	Installed and Operational		commissioned on 09.02.2024
	220kV Mahoba	Installed but Non-Operational		Relay is faulty since 29.01.2024
	220kV Sarnath	Installed but Non-Operational	Revised date not received	
	220kV Sirathu, Kaushambi	Not Installed	Revised date not received	
	220kV substation Fatehpur	Installed and Operational		Operational
	220kV S/S Bhelupur	Not Installed		Radial feeder
	220kV Hardoi Road, Lucknow	Installed and Operational		commissioned on 08th October 2023
	220kV CG City, Lucknow	Installed but Non-Operational	31.05.2024	Agency M/s. Electro Power is decided.
	220kV Barabanki	Installed but Non-Operational	31.05.2024	Agency M/s. Electro Power is decided. 02 no. Peripheral unit found defective.
	220kV Kursi Road, Lucknow	Installed but Non-Operational	31.05.2024	Retrofitting work of auxilliary relay completed. Dut to non-functioning of new
	220kV BKT, Lucknow	Installed but Non-Operational	31.05.2024	LOI issued on Dt. 28.02.24
	220kV Gomti Nagar, Lucknow	Installed but Non-Operational	31.05.2024	Agency M/s. Electro Power is decided.
	400 KV Substation Sarnath	Installed and Operational		Now operational
	220kV S/S Raja Talab	Installed but Non-Operational	Revised date not received	Relay Defective, concern firm service engineer is awaited
	20kV S/S HaraHua	Installed but Non-Operational	Revised date not received	NOT COMMISSIONED
	220kV Rewa Road	Installed but Non-Operational	Revised date not received	Due to Isolator & CB status not Proper. Informed to Transmission wing but
	220kV S/S Sahupuri	Installed but Non-Operational	Revised date not received	Defective, Requirement for New panel has been raised, not received from
	220kV Robertganj	partilly operational	Revised date not received	Line and bus coupler and T/F-I under cover but T/F-II not cover
	220kV S/S Mirzapur	Not Installed	Revised date not received	Bubar Protection Panel has been Recived, construction of Transfer bus is on progress
HP	220kV Chamba	Installed and Operational		commissioned in Jan-2024
	220kV MattaSidh	Installed but Non-Operational		
	220kV kangoo	Installed but Non-Operational	31.12.2024	Work in under progress, issues are being taken up with ABB
	220kV Nangal	Installed but Non-Operational		
	220kV Katha Baddi	Installed but Non-Operational		
Punjab	220 KV S/S Kotlisurat Malhi	Not Installed	Dec-24	Commissioning is in process. Material has arrived, commissioning shall be done as per shutdown availability.
	220 KV S/S Maur	Not Installed		
	220 KV S/S Science city	Not Installed		
	220 KV S/S Banga	Not Installed		
	220 KV S/S Hoshiarpur	Not Installed		
	220 KV S/S Goraya	Not Installed		
	220 KV S/S Bhawanigarh	Not Installed		
	220 KV S/S Badhni kalan	Installed and Operational		Commissioned
	220 KV S/S Bhari	Installed and Operational		Commissioned
Rajasthan	765 KV GSS Phagi	Installed but non operational		CU of Alstom make Bus-Bar is defective. Purchas case will be taken up
	220 kv GSS Vatika	Not installed	Sep-24	As M/s ER did not finished the project, so it was awarded to M/s Kaycee infra on risk-cost basis , however the bus bar scheme has not been commissioned yet. Matter has been taken up with firm
	220 kv GSS Niwana	Not installed		Commissioning work started, to be commissioned shortly
	220 kv GSS Alwar	Not installed		Commissioning work started, to be commissioned shortly
	220 kv GSS Bansur	Not installed		Commissioning work started, to be commissioned shortly
	220 kv GSS Behror	Not installed		Commissioning work started, to be commissioned shortly
	220KV GSS Hindaun	Not installed		Commissioning work started, to be commissioned shortly
	220KV GSS Dooni	Installed and Operational		commissioned
	220KV GSS Bhawanimandi	Installed and Operational		commissioned
	220 KV GSS Sakatpura, Kota	Installed and Operational		commissioned on 09.07.2024
	400 KV GSS Ajmer (220 KV BUS)	Installed but non operational	Revised date not received	One number of PU is defective. Isolator status is OK.
	220 kv GSS, Beawar	Installed and Operational		commissioned
	220 KV GSS Jethana	Installed and Operational		commissioned
	220 KV GSS Kuchaman City	Installed but non operational	Revised date not received	CU is defective. Purchase has been taken up with the firm
	220 KV GSS Bherunda	Installed and Operational		commissioned
	220 KV GSS Kuchera	Installed and Operational		commissioned
	220 KV GSS Reengus	Installed and Operational		commissioned
	220 KV GSS Laxmangarh	Installed and Operational		Commissioned
	220KV GSS Khetri Nagar	Installed and Operational		commissioned
	400 KV GSS, Babai	Installed and Operational		commissioned
	220 KV GSS Chittorgarh	Installed and Operational		commissioned
	400 KV GSS BHILWARA(220 KV BUS)	Installed and Operational		commissioned
	220 KV GSS MANDALGARH	Installed and Operational		commissioned
	220KV GSS Debari	Installed and Operational		commissioned
	220KV GSS Amberi	Installed and Operational		commissioned
	220KV GSS Madri	Installed and Operational		commissioned
	400 KV GSS Surpura (Jodhpur) 220 KV	Installed but non operational	30.09.2024	Commissioning work started, to be commissioned shortly

400 KV GSS Akal (Jaisalmer) 220 KV	Installed but non operational	Revised date not received	One PU defective. Case has been taken up with firm
220 KV GSS Jodhpur	Installed but non operational	Revised date not received	A&FS and TS issued. Case has been send for approval
220 KV GSS NPH Jodhpur	Not installed	Revised date not received	Case file moved
220 KV GSS Badisid	Installed and Operational		commissioned
220 KV GSS Bhadla	Not installed	25.09.2024	Commissioning work started, to be commissioned shortly
220 KV GSS Pali	Installed and Operational		commissioned
220 KV GSS Ramgarh	Not installed	05.09.2024	Commissioning work started, to be commissioned shortly
220 KV GSS Balotra	Installed and Operational		commissioned
220 KV GSS Sayla	Installed and Operational		commissioned
400 KV GSS Bikaner 400 KV BUS	Installed but non operational	Revised date not received	to be done with transformer work
220 KV GSS Ratangarh	Installed and Operational		commissioned
220 KV GSS Sujangarh	Installed and Operational		commissioned
220 KV GSS Halasar	Installed and Operational		commissioned
220 KV GSS Tehandesar	Not installed	15.09.2024	Commissioning work started, to be commissioned shortly
220 KV GSS Rawatsar	Installed and Operational		commissioned

Status of protection relay type				
Constituent Name	Name of Station	Element Name	Present Status	Remark
Uttarakhand	220kV Rishikesh	SIDCUL line	Main-II is not installed	
		Chamba line		
		Dharasu line-2		
		Rishikesh line		
HP	220kV MattaSidh	220kV transformer bank-1 & 2	Static relay	
		220 kV GSS Sanganer	220 kV HEERAPURA	Static
	220 kV GSS Phulera	220 kV HEERAPURA	Static	Replaced by numerical relay
		220 kV Makrana	Static	
220 KV GSS CHOMU	220 kV Heerapura	Static		
	220 kV Reengus Line	Static		
220 kV GSS Kukas	220 kV Manoharpur Line	Static	Replaced by numerical relay	
	220 kV Alwar Line	Static		
220kV GSS Dausa	220 kV SawaiMadhopur Line	Static		
	220 kV Bassi-I Line	Static		
	220 kV Bassi-II Line	Static		
	220 kV Alwar Line	Static		
220kV GSS Mandawar Line	220 kV Mandawar Line	Static		
	220KV BHARATPUR GSS	220 KV DHOLPUR	Static	Replaced by numerical relay
220 KV GSS SAKATPURA	220 KV ANTA(NTPC)	Static		
220 KV DAHRA	220 KV BARAN	Static		
	220 kV SAKATPURA	Static		
220KV GSS MODAK	220 kV RANPUR	Static		
	220 kV Jhalawar	Static		
220 KV GSS JHALAWAR	220 kV Modak	Static		
220KV GSS HINDAUN	220KV Sikrai Line	Static	relay defective	
220KV GSS DHOLPUR	220 kV DCCP	Static	Replaced by numerical relay	
220 KV GSS Reengus	220 KV Laxmangarh	Static		
220 KV GSS Nagour	220KV NOKHA	Static		
	220KV KUCHERA	Static		
220KV GSS Kankroli	220 KV PGCIL-I	Static		
220 KV GSS SIROHI	220 KV (400) KV PGCIL Bhinmal	Static		
220 KV GSS SIROHI	220 KV Jalore	Static		
220 KV GSS BHINMAL	220 KV (400) KV PGCIL Bhinmal-I	Static		
220 KV GSS BALI	220KV Sirohi	Static	Replaced by numerical relay	
220 KV GSS Suratgarh	220 KV STPS-I	Static		
	220 KV STPS-II	Static		
	220 KV Hanumangarh Line	Static		
220 KV GSS Sri Ganganagar	220 KV Hanumangarh Line	Static	Replaced by numerical relay	
220 KV GSS Hanumangarh	220 KV Suratgarh	Static		
220KV GSS Ratangarh	220KV Rawatsar	Static		
220KV GSS Ratangarh	220KV Halasar	Static		
220KV GSS Ratangarh	220KV InterConnector-I	Static		
220KV GSS Ratangarh	220KV InterConnector-II	Static		
220KV GSS Sujangarh	220KV Ratangarh	Static		
220 KV GSS Bikaner	220 KV Badnu Line	Static		
220 KV GSS Bikaner	220 KV Interconnector-I Line	Static		
220 KV GSS Bikaner	220 KV Spare Line	Static		
	220kV Madanpur	220/66kV 100 MVA PTF T-1	Electromechanical	Working properly, need to be replace with numerical relay
		220/66kV 100 MVA PTF T-1 A	Electromechanical Except Differential relay (Numerical)	Working properly, need to be replace with numerical relay
		220kV Bus-Coupler	All relays are Numerical	New 220 KV C&R panel replaced on dated 26.05.2022
		220/66kV 100 MVA PTF T-1 A	Electromechanical Except Differential relay (Numerical)	Working properly, need to be replace with numerical relay
	220 KV S/Stn Shahbad	100 MVA 220/66 KV T/F T-1	All relays are electromechanical and static	New C&R panel laying at S/Stn.for commissioning
		220 KV Bus Coupler	Electromechanical	Working properly, need to be replace with numerical relay
	220 KV S/StnTepla	220KV Bus Coupler	Electromechanical	Working properly, need to be replace with numerical relay
		220KV Jorian -DCRTPP Ckt-1	Main-1 & Main-2 = Numerical all other Electromechanical	Working properly, need to be replace with numerical relay
		220KV Jorian -DCRTPP Ckt-2	Main-1 & Main-2 = Numerical all other Electromechanical	Working properly, need to be replace with numerical relay
		220KV Jorian -Shahbad Ckt-1	Main-1 & Main-2 = Numerical all other Electromechanical	Working properly, need to be replace with numerical relay

Haryana

220KV S/Stn Jorian	220KV Jorian -Shahbad Ckt-2	Main-1 & Main-2 = Numerical all other Electromechanical	Working properly, need to be replace with numerical relay
	220KV Jorian -Abdullapur Ckt-1	Main-1 & Main-2 = Numerical all other Electromechanical	Working properly, need to be replace with numerical relay
	220KV Jorian -Abdullapur Ckt-2	Main-1 & Main-2 = Numerical all other Electromechanical	Working properly, need to be replace with numerical relay
	220/66, 160MVA T/F T-1	Defferntial Relay = Numerical all other Electromechanical	Working properly, need to be replace with numerical relay
	220/66, 100MVA T/F T-2	All Electromechanical	Working properly, need to be replace with numerical relay
	220/66, 100MVA T/F T-3	Defferntial & REF Relay = Numerical all other Electromechanical	Working properly, need to be replace with numerical relay
220 kv Salempur	220 KV BAKANA-SALEMPUR CKT-I	All electromechanical type,except DPR relays	Working properly, need to be replace with numerical relay
	220 KV BAKANA-SALEMPUR CKT-II	All electromechanical type,except DPR relays	Working properly, need to be replace with numerical relay
	220 KV SALEMPUR-NISSING CKT-I	All electromechanical type,except DPR relays	Working properly, need to be replace with numerical relay
	220 KV SALEMPUR-NISSING CKT-II	All electromechanical type,except DPR relays	Working properly, need to be replace with numerical relay
	220 KV BUS-COUPLER	All electromechanical type	Working properly, need to be replace with numerical relay
	220/66 KV 100MVA T/F T-1	All electromechanical type,except Differential relays	Working properly, need to be replace with numerical relay
	220/66 KV 100MVA T/F T-2	All electromechanical type,except Differential relays	Working properly, need to be replace with numerical relay
TS Division Karnal	220kv Nissing-PTPS Ckt-I	Main-1 & Main-2 = Numerical, other (O/C+E/F) Electromechanical	Only Backup relays are electromechanical
	100 MVA 220/132KV T-8	R. E. F & Differential relays are Numerical, other (O/C+E/F) Electromechanical	Working properly, need to be replace with numerical relay
	220 kv Bus-coupler	Bus bar protection and panel relay are Numerical	all relay are Numerical type
	220 KV DCRTPP-UNISPUR CKT-I	Main-1 & Main-2 = Numerical, other (O/C+E/F) Electromechanical	Only Backup relays are electromechanical relays need to be replaced with numerical
	220 KV DCRTPP-UNISPUR CKT-II	Main-1 & Main-2 = Numerical, other (O/C+E/F) Electromechanical	Only Backup relays are electromechanical
	220 KV KARNAL-UNISPUR LINE	Main-1 & Main-2 = Numerical, other (O/C+E/F) Electromechanical	Only Backup relays are electromechanical
	220/132 KV 100 MVA T/F T-1	R. E. F & Differential relays are Numerical, other (O/C) Electromechanical	Working properly, need to be replace with numerical relay
	220/132 KV 100 MVA T/F T-2	R. E. F & Differential relays are Numerical, other (O/C) Electromechanical	Working properly, need to be replace with numerical relay
220kv S/Stn Palla	220/132 KV 160 MVA T/F T-4	R. E. F & Differential relays are Numerical, other (O/C) Electromechanical	Working properly, need to be replace with numerical relay
	100MVA 220/66kv T-1	differential numerical, REF & Backup electromechanical	Working properly, need to be replace with numerical relay
	100MVA 220/66kv T-2	differential numerical, REF & Backup electromechanical	Working properly, need to be replace with numerical relay
	100MVA 220/66kv T-7	differential & Backup electromechanical, REF static	Working properly, need to be replace with numerical relay
	220kv Palla - Sector 78	DPR numerical, Backup electromechanical	Only Backup relays are electromechanical
220 kv S/Stn. Pali	220kv Palla - FGPP ckt-II	DPR numerical, Backup electromechanical	Only Backup relays are electromechanical
	100 MVA 220/66 kv T-1	differential numerical, REF & Backup electromechanical	Working properly, need to be replace with numerical relay
	100 MVA 220/66 kv T-3	differential numerical, REF & Backup electromechanical	Working properly, need to be replace with numerical relay
	220 kv Pali-BBMB Samaypur Ckt 1	DPR numerical, Backup electromechanical	Only Backup relays are electromechanical
	220 kv Pali-BBMB Samaypur Ckt 2	DPR numerical, Backup electromechanical	Only Backup relays are electromechanical
	220 kv Pali-Sector 46 Ckt 1	DPR numerical, Backup electromechanical	Only Backup relays are electromechanical
	220 kv Pali-Sector 46 Ckt 2	DPR numerical, Backup electromechanical	Only Backup relays are electromechanical
	220 kv Pali-Sector 65 Ckt 1	DPR numerical, Backup electromechanical	Only Backup relays are electromechanical
	220 kv Pali-Badshahpur Ckt 2	DPR numerical, Backup electromechanical	Only Backup relays are electromechanical
	220 kv Pali-Sector 56 Ckt 1	DPR numerical, Backup electromechanical	Only Backup relays are electromechanical
220kv S/Stn Palwal	220/66kv 160MVA T-1 T/F	differential numerical, REF & Backup electromechanical	Working properly, need to be replace with numerical relay
	220/66kv 100MVA T-2 T/F	all electromechanical	Working properly, need to be replace with numerical relay
	220kv Prithala Palwal Ckt I	DPR numerical, Backup electromechanical	Only Backup relays are electromechanical
	220kv Prithala Palwal Ckt II	DPR numerical, Backup electromechanical	Only Backup relays are electromechanical
220kv S/Stn. Sector 52A GGM	Sec 56-Sec 52A ckt 1	DPR numerical, Backup electromechanical	Only Backup relays are electromechanical
	Sec 56-Sec 52A ckt 2	DPR numerical, Backup electromechanical	Only Backup relays are electromechanical
	Sec 72-Sec 52A	DPR numerical, Backup electromechanical	Only Backup relays are electromechanical
	Sec 57-Sec 52A	DPR numerical, Backup electromechanical	Only Backup relays are electromechanical
220kv Sonipat	220KV Barhi-Sonepat Line	DPR numerical, Backup electromechanical	Working properly and the respective C&R panels are to be changed with new C&R panels having all numerical /digital relays. The estimate 220/132KV 100MVA T-4 T/F is sanctioned and others is under preparation to replace the same.
	220/132KV 100MVA T-3 T/F	Differential,REF and O/C ,E/F relays are Electromechanical	
	220/132KV 100MVA T-4 T/F	Differential,REF and O/C ,E/F relays are Electromechanical	
	220/132KV 100MVA T-5 T/F	Differential,REF and O/C ,E/F relays are Electromechanical	

220kV Rohtak	220 KV Rohtak - Kabulpur line	DPR numerical but E/F are conventional	The Numerical O/c has been replaced.
	220 KV Rohtak - Sampla line	DPR numerical but E/F are conventional	
	220 KV Rohtak - PTPS Ckt-1	DPR numerical but E/F are conventional	
	220 KV Rohtak - PTPS Ckt-2	DPR numerical but E/F are conventional	
	100 MVA, 220/132 KV T-3 T/F,	Differential relay numerical but O/C conventional.	The relay has been replaced with the numerical relay.
	100 MVA, 220/132 KV T-4 T/F,	Differential relay numerical but O/C and REF conventional.	
	100 MVA, 220/132 KV T-6 T/F,	Differential relay numerical but O/C and REF conventional.	
	220kV Bus-Coupler	all relays are conventional	The Numerical O/c has been replaced.
220kV Nuna Majra	220 Kv Nuna Majra-Sampla Ckt-1	DPR Numerical, Earth fault electromechanical	Working properly, need to be replace with numerical relay in Phased manner. The estimates is under sanction to replace the same.
	220 Kv Nuna Majra-Sampla Ckt-2	DPR Numerical, Earth fault electromechanical	
	220 Kv Nuna Majra-PGCIL Ckt-1	DPR Numerical, Earth fault electromechanical	
	220 Kv Nuna Majra-PGCIL Ckt-2	DPR Numerical, Earth fault electromechanical	
	220 Kv Nuna Majra-Sector-107	DPR Numerical, Earth fault electromechanical	
	220 Kv Nuna Majra-Daultabad	DPR Numerical, Earth fault electromechanical	
	100 MVA,220/132 KV T/F T-1	Differential and REF Numerical,Non directional Over Current Electromechanical	
	100 MVA,220/132 KV T/F T-2	Differential and REF Numerical,Non directional Over Current Electromechanical	
	100 MVA,220/132 KV T/F T-4	Differential and REF Numerical,Non directional Over Current Electromechanical	

UP	400 KV S/S Moradabad	400 KV MORADABAD - RAMPUR LINE	LBB- ABB(RAICA) / STATIC	UNDER PGCIL
		400 KV MORADABAD - KASHIPUR LINE	LBB- English Electric(CTIG) / Electromechanical	
		400 KV, TRANSFER BUS	LBB- English Electric(CTIG) / Electromechanical	
		400 KV, BUS COUPLER	LBB- English Electric(CTIG) / Electromechanical	
	220kv S/S BARAUT	220/132kv 200MVA TRANSFORMER-1	REF Protection - Electromechanical	
	220kv S/S BAGHPAT	220/132kv 160MVA TRANSORMER-1	Backup (L.V. Side) - Electromechanical	
	220 kv KHURJA	220/132kv 200MVA Transformer-I	REF-Static	
	220 kv DEBAI	220/132kv 100MVA Transformer-I	Numerical	Will be replaced by July24
	220 KV Jahangirabad	220/132Kv 160MVA Transformer-I	REF-Static	
	400KV S/S MURAD NAGAR	220KV LONI LINE	O/C & E/F RELAY IS ELECTROMECHANICAL.	
		220KV FARID NAGAR LINE	O/C & E/F RELAY IS ELECTROMECHANICAL.	
		220KV INTER CONNECTOR-I MURAD NAGAR LINE	O/C & E/F RELAY IS ELECTROMECHANICAL.	
		220KV INTER CONNECTOR-II MURAD NAGAR LINE	O/C & E/F RELAY IS ELECTROMECHANICAL.	
		220KV SAHIBABAD LINE	O/C & E/F RELAY IS ELECTROMECHANICAL.	
		220KV PRATAP VIHAR LINE	O/C & E/F RELAY IS ELECTROMECHANICAL.	
		220KV TBC	O/C & E/F RELAY IS ELECTROMECHANICAL.	
		400KV TBC	O/C & E/F RELAY IS ELECTROMECHANICAL.	
		400KV ALGARH LINE	LBB RELAY IS ELECTROMECHANICAL.	
		400KV ATOUR LINE	LBB RELAY IS ELECTROMECHANICAL.	
	220KV S/S MURAD NAGAR	220KV BUS COUPLER	O/C RELAY IS ELECTROMECHANICAL	
	400KV S/S Gorakhpur	400KV TBC	Electromechanical	
		220KV TBC	Electromechanical	
	220KV S/S Barahua	220KV PGCIL	Back up relay electromechanical	
	220KV S/S Basti	220 KV Basti Tanda line	67N(2TJM12)(Electromechanical)	
		63MVA Transformer-II	HV Side directional o/c&e/f(Electromechanical)	
	400 KV SS Kasara,Mau	200MVA, 400/132KV ICT-1st	REF & Over flux relay Electromechanical	
		200MVA, 400/132KV ICT-2nd	REF & Over flux relay Electromechanical	
	220 KV SS Substation Hafizpur Azamgarh	160 MVA ICT -1	Electromechanical( EE Make)	Replaced with Siemens make numerical relay on 16.10.2023
	220kv Khara		Electromechanical	process of replacing electrochemical relay with numerical relay has been started, it will be completed within 2-3 months.
	220kv Gokul	160MVA ICT-1	Electromechanical (Diff and O/C)	
	220kv Meetai	200MVA ICT-1	Electromechanical (E/F and O/C), Diff:Static	New panels are available at S/s and replacement work is under process
		200MVA ICT-2	Electromechanical (E/F and O/C), Diff:Static	
	220kv Atrauli	160MVA ICT-1	Electromechanical + Numerical	Tender process is complete.
160MVA ICT-2		Electromechanical + Numerical		
220kv Mainpuri	160MVA ICT-1	Electromechanical(REF) + Numerical	New panels are available at S/s and replacement work is under process	
	160MVA ICT-2	Electromechanical(REF) + Numerical		
220kv Panki	220KV Bus coupler	Electromechanical	Under process	
400kv S/S Sultanpur	240 MVA ICT-II	Non Numerical		
	50 MVAR Obra Line Reactor	Non Numerical		
220kv S/S Sultanpur	220kv B/C	Non Numerical		
	160 MVA T/F-I	Non Numerical		
NPCIL	220kv RAPP	220KV Anta line	Backup relay: Static relay(RAPDK3)	Completed
		NAPP-SAMBHAL		Completed
	220kv NAPP	NAPP-SIBHOLI		Completed
		NAPP-DIBAI		Completed
		NAPP-KHURJA		Completed
		NAPP-ATRAULI		Completed

**Details Of Protection Relay**

S. No.	Name of Division	Name of Substation	Element Name	Voltage Level	Protection Relays type Static/Electromechanical	Status of Action being taken		
						Tentative date for replacement of relay	Any other remarks	
1	T&CD, Shahjahanpur	220KV S/S Shahjahanpur	220KV Gola line	220KV	Backup Relay Electromechanical	30.06.2024		
		220KV S/S Hardoi	220KV Shahjahanpur line	220KV	Backup Relay Electromechanical	31.07.2024		
2	T&CD, Gonda	132 KV Sub Station Balrampur	132 KV Balrampur-Utraula line	132 kV	Electromechanical	30.05.2024		
			132 KV Balrampur- Chini Mill line	132 kV	Electromechanical	30.05.2024		
		132 KV Sub Station Mankapur	132 kv MCM line	132 kV	Electromechanical	30.05.2024	Main Distance Protection is Numerical but Back Up relay is Electromechanical	
		132 KV Sub Station Mankapur	5 MVA Ist(33 KV)	33 kV	Electromechanical	30.05.2024		
5 MVA IInd(33 KV)	33 kV		Electromechanical	30.05.2024				
3	T&CD, Sarojini Nagar	400/220kV UNNAO	400 KV UNNAO MOHANLALGANJ LINE	400 KV	STATIC(ABB RXEG21)	31.09.2024		
			400 KV UNNAO BAREILLY 1 LINE	400 KV	STATIC(ABB RXEG21)	31.09.2024		
			400 KV UNNAO BAREILLY 2 LINE	400 KV	STATIC(ABB RXEG21)	31.09.2024		
			400KV UNNAO- PANKI LINE	400 KV	STATIC(ABB RXEG21)	31.09.2024		
			400 KV UNNAO AGRA LINE	400 KV	STATIC(ABB RXEG21)	31.09.2024		
			400/220 KV 315 MVA ICT -1	400/220kV	STATIC(ABB RADSBRATUB,RADHD), Electromechanical(TJM12)	31.09.2024		
			50MVAR LINE REACTOR ON 400KV AGRA BAREILLY-1	400 KV	STATIC(ABB RADHA,RAKZB,RADHD)	31.09.2024		
			63MVAR BUS REACTOR	400 KV	STATIC(ABB RADHA,RAKZB,RADHD)	31.09.2024		
		220/132kV UNNAO	220 KV UNNAO-BITHOOR LINE	220KV	STATIC(ABB RXPE+RXIG)	31.09.2024		
			220 KV UNNAO-RPH LINE	220KV	STATIC(ABB RXPE+RXIG)	31.09.2024		
			220 KV UNNAO-GIS KANPUR ROAD LINE	220KV	STATIC(ABB RXPE+RXIG)	31.09.2024		
			220/132 KV 160 MVA ICT -1	220/132kV	STATIC(ABB RADSBRATUB,RADHD), Electromechanical(TJM12)	31.09.2024		
		220kV Sarojini Nagar		132kV TRT-1	132kV	Electro-Mechanical (EASUN REYROLLE (TJM12))	31.09.2024	
				132kV TRT-2	132kV	Electro-Mechanical (EASUN REYROLLE (TJM12))	31.09.2024	
				132kV RAHMABAD	132kV	Electro-Mechanical (EASUN REYROLLE (2TJM12))	31.09.2024	
				132kV SGGPI-1	132kV	Electro-Mechanical (EASUN REYROLLE (2TJM12))	31.09.2024	
				132kV BIJNOUR	132kV	Electro-Mechanical (EASUN REYROLLE (2TJM12))	31.09.2024	
200MVA T/F-2	132kV	Electro-Mechanical (AREVA (CAG14AF12A))	31.09.2024					
4	T&CD, Sultanpur	400kV S/S Sultanpur	400/220kV, 240MVA ICT-II	400/220kV	Diff:- (English Electric- DTH32), O/C&E/F:- (English Electric type-CDD)	31.08.2024		
			50MVAR Obra line Reactor	400kV	Diff:- (English Electric type-CAG), Backup:- (English Electric type-YTG33)	30.09.2024		
		220kV S/S Sultanpur	220kV Bus Coupler	220KV	English Electric type-CDG	31.07.2024		
5	T&CD, Bareilly	400KV S/S Bareilly	220/132kV, 160MVA T/F-I	220/132kV	Diff:- (English Electric DMH3232DF1A5), O/C&E/F (HV):- (English Electric CDG 61EG8081BX), O/C&E/F (LV):- (English Electric CDG 31EG164A5), REF:- (English Electric CAG 14AF12A)	30.06.2024		
			315 MVA ICT-1	400/220KV	Diff/ REF/ Over flux/ LBB/ HV & LV Backup Relay Electromechanical	Requisition of relay sent		
			80 MVAR Bus Reactor	400 KV	Diff/ REF/ Backup Impedance Relay Electromechanical	Requisition of relay sent		
			220 KV CB GANJ Ckt-1	220 KV	DIR E/F & LBB RELAY STATIC	Requisition of relay sent		
		220 KV PANTNAGAR	220 KV	DIR E/F & LBB RELAY STATIC	Requisition of relay sent			
220 KV PILBHHT CKT-2	220 KV	DIR E/F & LBB RELAY STATIC	Requisition of relay sent					
220 KV S/S CB Ganj	200/132 KV 200 MVA T/F-II	220KV	Main Reyrolle Duo Bias M / Backup(ERL-Electro Mechanical)	Requisition of relay sent				
6	T&CD, Lucknow	220 KV CHINHAT	220/132 KV 200 MVA T/F-II ADITYA	220KV	ELECTROMECHANICAL (ESUN REYROLL, 2TJM12,2TJM12)REF.HV &LV BU			
		220 KV GOMTINAGAR	220/33 KV 60 MVA T/F -I	220KV	ELECTROMECHANICAL AREVA MAKE HV & LV REF			
			220/33 KV 60 MVA T/F -II	220KV	ELECTROMECHANICAL AREVA MAKE HV & LV REF			





**Format for Station Event logger/SAS status**

S. No.	Name of Division	Name of the station	Voltage Level (in kV)	Availability of station event logger	Healthiness of Event Logger	Is event logger time synchronised with GPS (Yes/No)	Date of commissioning / rectification of station event logger (in case of non-existence or unhelathy EL)	Status of Action being taken	
								Tenative date for commissioning/healthiness	Any other remarks
1	T&CD, Shahjahanpur	220KV S/S Shahjahanpur	220KV	No	No	No	No	No	No
		220KV S/S Azizpur	220KV	YES	YES	YES			
		220KV S/S Hardoi	220KV	No	No	No	No	No	No
		220KV S/S Mallawa	220KV	YES	YES	YES			
		220 KV SITAPUR	220KV	No	No	No	No	No	No
		220 KV KANDUNI	220 KV	YES	YES	NO			
		220 KV NIGHASAN	220KV	YES	YES	NO			
		220 KV GOLA	220KV	YES	YES	YES			
2	T&CD, Gonda	220 KV GONDA	220/132/33 KV	NOT AVAILABLE					
		220 KV BALRAMPUR	220/132/33 KV	NOT AVAILABLE					
		220KV BAHRAICH	220/132/33 KV	NOT AVAILABLE					
3	T&CD, Sarojini Nagar	765kV Unnao	765kV	No	-	-	-	31.08.2024	-
		400kV Unnao	400kV	Yes	Healthy	No	31.05.2024	-	-
		400kV Sarojini Nagar	400kV	Yes	Unhealthy	-	31.05.2024	-	-
		220kV Sarojini Nagar	220kV	No	-	-	-	31.08.2024	-
		220kV/33kV Dam Chandi Unnao	220kV	Yes	Healthy	Yes	-	-	
4	T&CD, Sultanpur	400kV S/S Sultanpur	400/220kV	Yes	Unhealthy	No	May-15	31.07.2024	Hard Disc of Event Logger Industrial PC (Advantech make) crashed and ELB relay defective in Event Logger Panel. It is requested to Executive Engineer, Electy 400kV S/S Division, Sultanpur for an early repair/replacement of defective elements of Event Logger.
		220kV S/S Sultanpur	220kV	NO	Not Available	Not Available	Not Available	-	-
		220kV S/S Amethi	220kV	YES	Healthy	yes	04.04.2018	-	SAS Based Event Logger
		220kV S/S Bachhrawan	220kV	YES	Healthy	yes	26.05.2018	-	SAS Based Event Logger
		220kV S/S New Tanda	220kV	NO	Not Available	Not Available	Not Available	-	-
		220kV S/S Sohawal	220kV	NO	Not Available	Not Available	Not Available	-	-
		220kV S/S GIS Ayodhya	220kV	NO	Not Available	Not Available	Not Available	-	-
5	T&CD, Bareilly	400KV S/S BAREILLY	400KV	YES	YES	YES	-	-	All elements not connected due to exhausted capacity
		220KV S/S DOHNA	220KV	YES	YES	YES	-	-	
		220KV S/S DOHNA	220KV	No	N/A	N/A	-	-	-
		220 KV PILIBHIT	220KV	SAS	YES	NO	-	-	-
		220 KV AMARIYA	220 KV	SAS	YES	YES	-	-	-
		220 KV Badaun	220 KV	Not Installed					
		220 KV Dataganj	220 KV	SAS	Yes	Yes			
		220 KV C B ganj	220 KV	Not Installed					
		220 KV Faridpur	220 KV	SAS	No				
6	T&CD, Lucknow	220KV Hardoi Rd	220KV	No					
		220KV GIS Kanpur Rd	220KV	Yes	Yes	Yes	-	-	
		220KV Bijnor Rd.	220KV	Yes	Yes	Yes	-	-	
		220 KV SS CHINHAT	220 KV	NO	NA	NA			
		220 KV SS C G CITY	220 KV	NOT WORKING	Unhealthy	NA			
		220 KV SS K ROAD	220 KV	YES	Healthy	SYNC			
		220 KV SS BKT	220 KV	YES	Healthy	SYNC			
		220 KV SS GOMTI NAGAR	220 KV	NO	NA	NA			
		220 KV SS SATRIKH ROAD	220 KV	YES	Healthy	SYNC			
		220 KV SS BARABANKI	220 KV	YES	Healthy	SYNC			



**ELECTRICITY TEST & COMMISSIONING CIRCLE, MEERUT****TRANSMISSION WEST ZONE UPPTCL,MEERUT****Status of recording instruments(220kV and above stations)****Annexure-XVII****Date: 18.9.24**

<b>Sr.No</b>	<b>Station Name</b>	<b>Voltage Level</b>	<b>Disturbance recorder/station event logger healthy (Yes or No)</b>	<b>Standardisation (Yes or No)</b>	<b>Time synch (Yes or No)</b>	<b>Remarks</b>
1	220 kV SS CHANDPUR	220 kV	DR and event logger are inbuilt in relays.(Yes) No centralised event logger is available.	Yes	Yes	
2	220 kV SS NEHTAUR	220 kV	DR and event logger are inbuilt in relays.(Yes) No centralised event logger is available.	Yes	Yes	
3	220 kV Amroha	220 kV	DR and event logger are inbuilt in relays.(Yes) No centralised event logger is available.	Yes	Yes	
4	220 kV Gajraula	220 kV	DR and event logger are inbuilt in relays.(Yes) No centralised event logger is available.	Yes	No	GPS clock is not working.
5	400kV S/S Moradabad	400kV	DR Inbuilt in Relay/Centralised Event Logger Available (Yes)	Yes	Yes	Relays are partially time Synchronized.
6	220kV S/S Sambhal	220kV	DR and event logger are inbuilt in relays.(Yes) No centralised event logger is available.	Yes	No	GPS clock is not working.
7	220kV S/S Chandausi	220kV	DR and event logger are inbuilt in relays.(Yes) No centralised event logger is available.	Yes	Yes	
8	220kV S/S Moradabad	220kV	DR and event logger are inbuilt in relays.(Yes) No centralised event logger is available.	Yes	Yes	Partially Relays are time Synchronized
9	220 kV SS Rampur	220 kV	DR and event logger are inbuilt in relays.(Yes) No centralised event logger is available.	Yes	Yes	

10	220kV Nara S/S MZN	220 kV	DR and event logger are inbuilt in relays.(Yes) No centralised event logger is available.	Yes	No	GPS clock unhealthy.
11	220kV BadhaiKalan S/S MZN	220 kV	DR and event logger are inbuilt in relays.(Yes) No centralised event logger is available.	Yes	Yes	
12	220kV Khatauli S/S MZN	220 kV	DR and event logger are inbuilt in relays.(Yes) No centralised event logger is available.	Yes	No	
13	220kV Jansath S/S MZN	220 kV	DR and event logger are inbuilt in relays.(Yes) No centralised event logger is available.	Yes	No	Communication cable laying pending.
14	400 kV S/S GIS Shamli	400 kV	DR is inbuilt in relays.(Yes). Centralised event logger is part of SAS.	Yes	Yes	
15	220 kV S/S Shamli	220 kV	DR and event logger are inbuilt in relays.(Yes) No centralised event logger is available.	Yes	No	GPS Clock not available
16	400 kV S/S MUZAFFARNAGAR	400 kV	DR is inbuilt in relays.(Yes) Centralised event logger is available.	Yes	Yes	
17	220 kV Saharanpur	220kV	DR and event logger are inbuilt in relays.(Yes) No centralised event logger is available.	Yes	No	
18	220 kV Behat	220kV	DR is inbuilt in relays.(Yes). Centralised event logger is part of SAS.	No	No	
19	220kV Sarsawa	220kV	DR is inbuilt in relays.(Yes). Centralised event logger is part of SAS.	Yes	No	
20	220 kV Nanauta	220 kV	DR and event logger are inbuilt in relays.(Yes) No centralised event logger is available.	Yes	No	GPS Clock not available
21	220 kV Deoband	220 kV	DR is inbuilt in relays.(Yes). Centralised event logger is part of SAS.	Yes	Yes	
22	220kV S/S SEC 62	220kV	DR and event logger are inbuilt in relays.(Yes) No centralised event logger is available.	Yes	No	GPS clock is defective
23	220kV S/S DADRI	220kV	DR and event logger are inbuilt in relays.(Yes) No centralised event logger is available.	Yes	No	GPS clock to relay wiring pending
24	220kV S/S RC GREEN	220kV	DR is inbuilt in relays.(Yes). Centralised event logger is part of SAS.	Yes	No	SAS unhealthy

25	220kV S/S JALPURA	220kV	DR is inbuilt in relays.(Yes). Centralised event logger is part of SAS.	Yes	Yes	
26	220kV S/S KP5	220kV	DR is inbuilt in relays.(Yes). Centralised event logger is part of SAS.	Yes	Yes	
27	220kV S/S JEWAR	220kV	DR is inbuilt in relays.(Yes). Centralised event logger is part of SAS.	Yes	Yes	
28	220kV S/S METRO DEPOT	220kV	DR is inbuilt in relays.(Yes). Centralised event logger is part of SAS.	Yes	Yes	
29	220kV S/S SEC 20	220kV	DR and event logger are inbuilt in relays.(Yes) No centralised event logger is available.	Yes	No	GPS clock to relay wiring pending
30	220kV S/S SEC 129	220kV	DR and event logger are inbuilt in relays.(Yes) No centralised event logger is available.	Yes	No	GPS clock is defective
31	220kV S/S BOTANICAL GARDEN	220kV	DR is inbuilt in relays.(Yes). Centralised event logger is part of SAS.	Yes	Yes	
32	400kV SEC 123	400kV	DR is inbuilt in relays.(Yes). Centralised event logger is part of SAS.	Yes	Yes	
33	400kV SEC 148	400kV	DR is inbuilt in relays.(Yes). Centralised event logger is part of SAS.	Yes	Yes	
34	220kV S/S SIKANDRABAD	220kV	DR and event logger are inbuilt in relays.(Yes) No centralised event logger is available.	Yes	No	GPS clock is defective
35	220kV S/S RUKHI	220kV	DR is inbuilt in relays.(Yes). Centralised event logger is part of SAS.	Yes	Yes	
36	400kV S/S GR NOIDA	400kV	DR inbuilt in relay.(Yes)/ Station Event Logger available	Yes	Yes	Few numerical relays (CSC211) do Not have the inbuilt time sync provision
37	220kV GIS S/S IITGNL	220kV	DR is inbuilt in relays.(Yes). Centralised event logger is part of SAS.	Yes	Yes	SAS Healthy
38	220kV S/S YEIDA SEC- 18	220kV	DR is inbuilt in relays.(Yes). Centralised event logger is part of SAS.	Yes	No	GPS clock not available
39	220kV S/S YEIDA SEC- 24	220kV	DR is inbuilt in relays.(Yes). Centralised event logger is part of SAS.	Yes	No	GPS clock not available

40	220 kV HYBRID S/S HAPUR	220kV	DR is inbuilt in relays.(Yes). Centralised event logger is part of SAS.	Yes	Yes	
41	220 kV S/S SIMBHAOLI	220kV	DR and event logger are inbuilt in relays.(Yes) No centralised event logger is available.	Yes	No	GPS clock is defective
42	220kV S/S KHURJA	220kV	DR and event logger are inbuilt in relays.(Yes) No centralised event logger is available.	Yes	No	GPS clock not available
43	220kV S/S JAHANGIRABAD	220kV	DR and event logger are inbuilt in relays.(Yes) No centralised event logger is available.	Yes	No	GPS clock is defective
44	220kV S/S DEBAI	220kV	DR is inbuilt in relays.(Yes). Centralised event logger is part of SAS.	Yes	Yes	
45	Shatabdinagar	220kV	DR and event logger are inbuilt in relays.(Yes) No centralised event logger is available.	Yes (Partial)	Yes	-----
46	Partapur (Jagriti Vihar)	220kV	DR is inbuilt in relays.(Yes). Centralised event logger is part of SAS.	Yes (Partial)	Yes	-----
47	Modipuram	220kV	DR and event logger are inbuilt in relays.(Yes) No centralised event logger is available.	Yes	No	GPS Clock is not Healthy
48	Modipuram-2	220kV	DR is inbuilt in relays.(Yes). Centralised event logger is part of SAS.	Yes	No	GPS Clock is not Healthy
49	Charla	220kV	DR and event logger are inbuilt in relays.(Yes) No centralised event logger is available.	Yes	No	GPS Clock is not Healthy
50	Baraut	220kV	DR and event logger are inbuilt in relays.(Yes) No centralised event logger is available.	Yes	Partially Synchronised	-----
51	Baghpat	220kV	DR and event logger are inbuilt in relays.(Yes) No centralised event logger is available.	Yes	Partially Synchronised	-----
52	Nirpura	220kV	DR and event logger are inbuilt in relays.(Yes) No centralised event logger is available.	Yes	No	GPS Clock is not Healthy

**Note:- No station event logger is available in any of the conventional 220kV Sub-stations under Transmission west zone Meerut UPPTCL.**

### Status of recording instruments (220 kV & above station of PTCUL)

SR NO	Station name	Voltage level	Disturbance recorder /Station event logger healthy (Yes or No)	Standardisation (Yes or No)	Time sync (Yes or No)	Remarks
1	400KV S/s Kashipur	400 kV	Inbuilt in Numerical Relays	YES	YES	
2	400KV RISHIKESH	400 kV	Inbuilt in Numerical Relays	YES	YES	
3	400KV SRINAGAR	400 kV	Inbuilt in Numerical Relays	YES	YES	
4	220KV S/s Mahuakheraganj	220 kV	Inbuilt in Numerical Relays	YES	YES	
5	220KV S/s Pantnagar	220 kV	Inbuilt in Numerical Relays	YES	NO	
6	220KV S/s Jafarpur	220 kV	Inbuilt in Numerical Relays	YES	NO	
7	220KV S/s Kamaluaganja	220 kV	Inbuilt in Numerical Relays	YES	NO	
8	220KV Jhajra	220 kV	Inbuilt in Numerical Relays	YES	YES	
9	220KV Rishikesh	220 kV	Inbuilt in Numerical Relays	YES	YES	
10	220KV IIP Harrawala	220 kV	Inbuilt in Numerical Relays	YES	YES	
11	220KV Chamba	220 kV	Inbuilt in Numerical Relays	YES	YES	
12	220KV SIDCUL, Haridwar	220 kV	Inbuilt in Numerical Relays	YES	NO	
13	220KV Pirankaliyar	220 kV	Inbuilt in Numerical Relays	YES	YES	
14	220KV Roorkee	220 kV	Inbuilt in Numerical Relays	YES	NO	

# **SPS of 500kV HVDC Mundra- Mahendergarh**



## SPS cases:

**Case-1:** Blocking of (one pole or Bipole) AND Reduction in power injection at Mahindergarh by more than 600 MW and up to 900 MW

**Action:** Shed 300 MW (Haryana: 150 MW, Punjab: 50 MW, Rajasthan: 50 MW, UP: 50 MW) identified load in Northern Region within 500 ms (including all signal propagation / breaker opening time delay).

**Case-2:** Blocking of (one pole or Bipole) AND Reduction in power injection at Mahindergarh by more than 900 MW and up to 1250 MW.

**Action:** Shed 600 MW (Haryana: 300 MW, Punjab: 100 MW, Rajasthan: 100 MW, UP: 100 MW) identified load in Northern Region within 500 ms (including all signal propagation / breaker opening time delay).

**Case-3:** Blocking of (one pole or Bipole) AND Reduction in power injection at Mahindergarh by more than 1250 MW and up to 2000 MW

**Action:** Shed 1400 MW (Haryana: 600 MW, Punjab: 200MW, Rajasthan: 200 MW, UP: 200 MW, Delhi: 200 MW) identified load in Northern Region within 500 ms (including all signal propagation / breaker opening time delay).

**Case-4:** Blocking of (one pole or Bipole) AND Reduction in power injection at Mahindergarh by more than 2000 MW

**Action:** Shed 1900 MW (Haryana: 700 MW, Punjab:300MW, Rajasthan: 300 MW, UP: 300 MW, Delhi: 300 MW) identified load in Northern Region within 500 ms (including all signal propagation / breaker opening time delay).

# Load Groups: In approved SPS

S. No.	State/ L.S. quantum	Name of feeding substation	Feeder/ line/ equipment	MW	Case-1 300MW	Case-2 600MW	Case-3 1400MW	Case-4 2000MW	
1	Rajasthan	220/132kV Alwar	132kV Mandawar	25	1	1	1	1	
2			132kV Bansoor	45		1	1	1	
3			132kV Ramgarh	14		1	1	1	
4			132kV Malakheda	10			1	1	
5			132kV Alwar(local load)	50				1	
6		Case-1: 50MW	220/132kV Ratangarh	132kV Sardar Shahar	26	1	1	1	1
7		Case-2: 100MW	220/132kV Bhilwara	132kV Gangapur	20			1	1
8		Case-3: 200MW		132kV Danta	15			1	1
9		Case-4: 300MW		132kV Devgarh	10			1	1
10			220/132kV Merta	132kV Kareda	10			1	1
11				132kV Kuchera	35			1	1
12				132kV Lamaba	25				1
13			132kV Gotan	25				1	
14	Haryana	400/220kV Bhiwani_BBMB	220kV Bapora D/C	65+65			1	1	
15		400/220kV Hissar_PG	220kV Isharwal D/C	40+35			1	1	
16		Case-1: 150MW Case-2: 300MW	400/220kV Dhanonda through 220kV Lula Ahir	220kV Rewari D/C (3x100MVA)	95+90	1	1	1	1
17		Case-3: 600MW Case-4: 700MW	400/220kV Bahadurgarh	220kV Nuna Majra D/C (3x100MVA)	80+80		1	1	1
18			132kV Charkhi Dadri	132kV Kalanaur	50			1	1

Existing feeders at 220/132kV Alwar  
(as per SCADA)

132kV Telco circle  
132kV KG Bas  
132kV Local MACL  
132kV Ramgarh  
132kV ALMIA  
132kV Pinan  
132kV Malakhera

# Load Groups: In approved SPS

19	Punjab	220/66kV Gobindgarh	66kV Talwara-1	35			1	1	
20			66kV Talwara-2	35				1	
21		220/66kV Laltokalan	66kV Gill Road-1	50		1	1	1	
22			66kV Gill Road-2	50	1	1	1	1	
23			66kV Dugri	65			1	1	
24		Case-1: 50MW	220/66kV Malerkotla	66kV Malerkotla	35				1
25		Case-2: 100MW		66kV Lasoi Amargarh	45				1
26		Case-3: 200MW		66kV Malaud\$	20				
27		Case-4: 300MW		66kV Siarh\$	20				
28		Uttar Pradesh	Shamli	Thana Bhagwan-1	25	1	1	1	
29	Thana Bhagwan-2			25	1	1	1		
30	Jasala-1			25		1	1		
31	Case-1: 50MW			Jasala-2	25		1	1	
32	Case-2: 100MW			Kharad-1	50			1	
33	Case-3: 200MW			Kharad-2	50			1	
34	Case-4: 300MW			Baraut-1	150				1
35				Baraut-2	150				1
36	Delhi	400/220kV Bamnauli	Papankalan1 ckt-1	100			1	1	
37	Case-1: 50MW		Papankalan1 ckt-2	100			1	1	
38	Case-2: 100MW	400/220kV Mandola	Gopalpur-1	150			1	1	
39	Case-3: 200MW Case-4: 300MW		Gopalpur-2	150			1	1	

\$: New feeder added in Punjab for peak demand period

132kV Feeders at 220kV Shamli	132kV Feeders at 400kV Shamli (alternate option)
132kV Lalukheri 132kV Jhinhana 132kV Kairana-1 & II 132kV Jasala	132kV Budhana 132kV Kharad 132kV Jalalpur 132kV Thanabhawan 132kV Kaniyan
Max. load: 251MW & Avg. Load: 164MW	Max. load: 310MW & Avg. Load: 202MW

### 220kV Papankalan has tow (02) source:

1. 220kV Bamnauli-Papankalan D/C
  2. 220kV Dwarka-Papankalan D/C
- ❖ All four feeders may be incorporated in SPS to ensure load relief in any scenario.





# SPS SCADA display at Mahindergarh (5-08-2024)

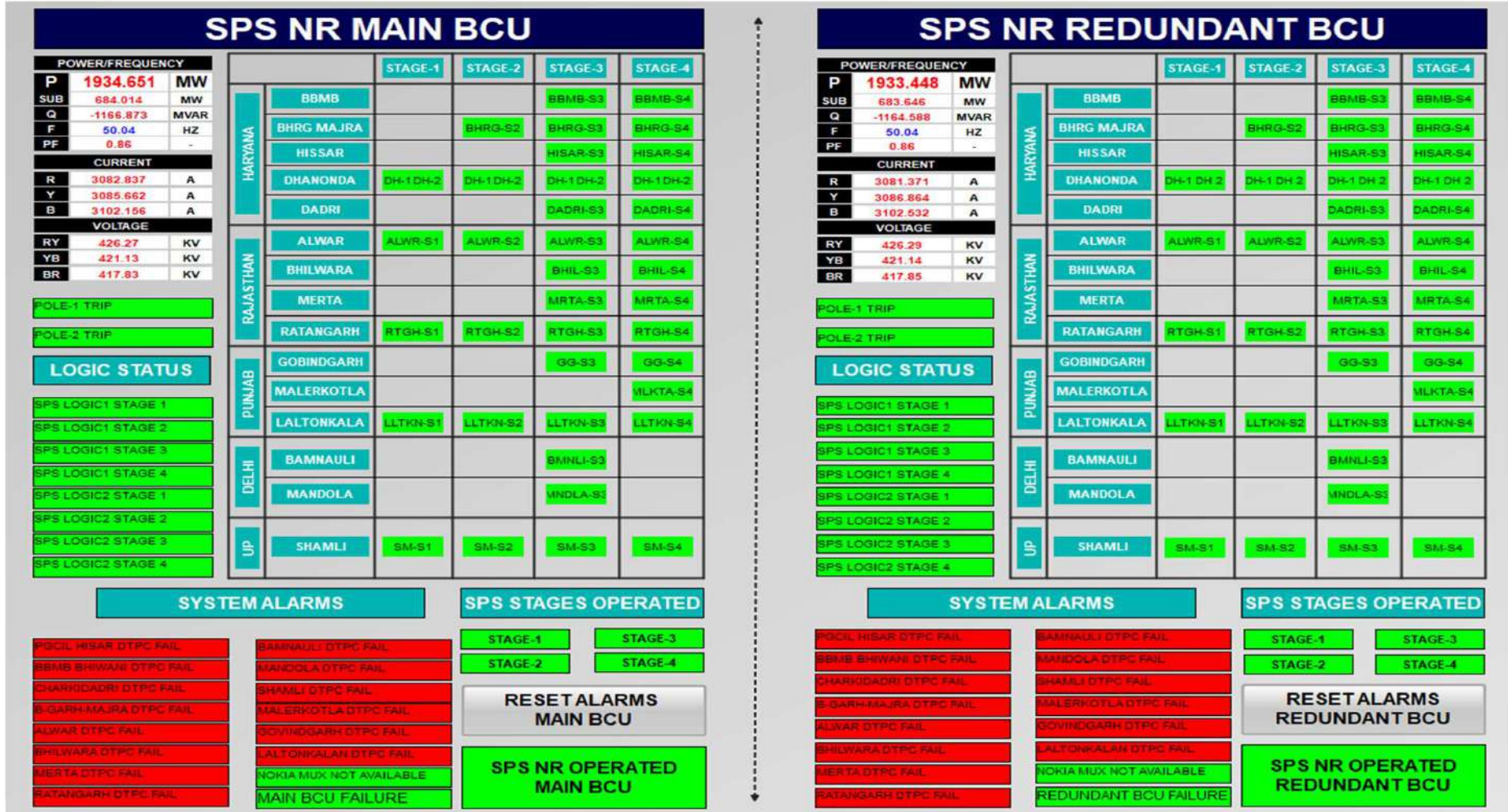

# Bipole tripping on 17<sup>th</sup> May 2024 (power order:1500MW)

SPS link to Dhanonda operated. SPS operation at other stations was not occurred.

8702 RELAY FAULTY		05.05.2024 06:42:19.183		Spontaneous
Reset LED	OFF	05.05.2024 06:43:24.710		Spontaneous
Reset LED	ON	06.05.2024 21:21:15.789	Command Issue	Spontaneous
LULAHIR-2 SPS TRIP	ON	06.05.2024 21:21:15.789	Com.Issued=Aut.	Spontaneous
DHANONDA-2 SPS OPERATED	ON	17.05.2024 16:20:37.796	Com.Issued=Aut.	Spontaneous
LULAHIR-2 SPS TRIP	OFF	17.05.2024 16:20:38.747	Com.Issued=Aut.	Spontaneous
DHANONDA-2 SPS OPERATED	OFF	17.05.2024 16:20:38.751	Com.Issued=Aut.	Spontaneous
Reset LED	ON	20.05.2024 11:06:40.580	Command Issue	Spontaneous
Reset LED	ON	20.05.2024 11:06:40.580	Com.Issued=Aut.	Spontaneous
DT SEND1	ON	06.05.2024 16:25:08.737		Spontaneous

## Format No.-PSA-01

**Application of protection settings for approval of NRPC**  
(for elements connected at 220 kV and above)

1. **Name of Utility:** HVPNL (Haryana Vidyut Prasaran Nigam Ltd)  
 2. **Sub-station:** 220 kV S/Stn. Masudpur (Distt. Hisar)  
 3. **Unit (Generator/ICT/GT/Reactor etc.)** 220/132 kV 100 MVA TF T-4  
 4. **Purpose of approval: New/Revision** New  
 5. **Tentative date for implementation:** 28.11.2024  
 6. **Settings proposed:**

S.N.	Protection	Setting	Time	Whether as per protection philosophy of NRPC
1.	Differential	Attached	--	As per CBIP manual, NRPC guidelines/HVFN practice/OEM recommendation
2.	REF	Attached	--	As per CBIP manual, NRPC guidelines/HVFN practice/OEM recommendation
3.	OC HV	Attached	--	As per CBIP manual, NRPC guidelines/HVFN practice/OEM recommendation
4.	LV OC - E/F	Attached	--	As per CBIP manual, NRPC guidelines/HVFN practice/OEM recommendation

7. **Supporting Calculation for submission:**

Attached.

Signature with date and seal

Executive Engineer  
M&P cum CC Division  
HVPNL, HISAR

**Protection setting (220 kV S/Stn. Masudpur)**  
**Utility : HVPNL**

<b>220/132 kV 100 MVA TF Protection</b>				
<b>1</b>	<b>Differential Protection for 100 MVA Transformer :</b>			<b>UNIT</b>
	Relay Used	=	ZIV 8IDV-A4F-230GB6	
	TF Capacity in MVA	=	100	MVA
	TF Total Capacity in MVA	=	100	MVA
	HV Voltage rating in kV	=	220	KV
	LV Voltage rating in kV	=	132	KV
	HV Side CT – Pri.	=	300	A
	HV Side CT - Sec.	=	0.577	A
	LV Side CT – Pri.	=	500	A
	LV Side CT - Sec	=	0.577	A
	Rated Voltage in kV	=	220	KV
	OLTC Range (Tap change on 132 kV side)	=	(+15% to -5%)	
	Voltage at Maximum tap (@+15%) in kV at Tap 1	=	151.8	KV
	Voltage at Minimum tap (@-5%) in kV at Tap 17	=	125.4	KV
<b>1.1</b>	<b>Backup Calculations :</b>			
	Capacity of the Transformer, Sref in MVA	=	100	MVA
	System voltage in KV	=	220	KV
	Transformer % Impedance (at max tap)	=	8.65	
	Transformer % Impedance (at normal. tap)	=	12.08	
	Transformer % Impedance (at min tap)	=	13.87	
	Vector Group	=	Yna0	
	Rated current of the Transformer HV side (in Primary)	=	Sref / ( $\sqrt{3}$ * HV voltage)	
		=	100 MVA / ( $\sqrt{3}$ * 220 kV)	
			262.43	A
	Rated current of the Transformer HV side (in Secondary)	=	262.4 / (300 / 0.577)	
		=	0.504	A
	HV Side CTR in relay	=	300 / 0.577	
		=	520	
	Rated current of the Transformer LV side	=	Sref / ( $\sqrt{3}$ * LV voltage)	
		=	100 MVA / ( $\sqrt{3}$ * 132 kV)	
		=	437.37	A
	Rated current of the Transformer LV side (in Secondary)	=	437.37 / (500 / 0.577)	
		=	0.504	A
	LV Side CTR in relay	=	500 / 0.577	
		=	866.5	
<b>1.2</b>	The following setting in the ZIV TF Differential protection as per technical manual & recommendation of ZIV.			
	<b>  General</b>			
	Unit In Service		Yes	
	Winding 1 ratio		520	
	Winding 2 ratio		866	
	Phase VT Ratio		2000	
	Neutral VT Ratio		2000	
	Gnd 1 CT Ratio		1	
	Gnd 2 CT Ratio		1	
	Phase Sequence		ABC	
	Voltage Type		Vab	
	Diff current measure		Times Tap	
	Reference Angle		IA Wndg 1	
	<b>Connection Groups</b>			
	Wndg 1 connection		WYE	
	ZS Filter wndg 1		Yes	
	Wndg 2 connection		WYE	
	Wndg 2 phase ang		0	
	ZS Filter wndg 2		Yes	
	Zero Seq Filter Type		Phase Channels	
	Gnd C1 Winding		1	
	Gnd C2 Winding		2	
	Autotransformer		Yes	
	<b>Protection</b>			
	<b>Differential Units</b>			
	Restraint Type (As per OEM recommendation)		(I1+I2-I <sub>d</sub> )/2	
	Reference Wndg		1	
	Tap winding 1		0.5	A
	Tap winding 2		0.5	A
	Fault Detector Supervision		Yes	



**Protection setting (220 kV S/Stn. Masudpur)**  
**Utility : HVPNL**

	<b>Differential</b>			
	Diff Enable		Yes	
	Sensitivity		0.2	pu
	Restraint slope 1		20	%
	R Slope 1 Start		0	pu
	Restraint slope 2		70	%
	R Slope 2 Start		2.5	pu
	Ext Fault Block Enable		Yes	
	Harmonic Restraint Mode		Continuous	
	Diff Time Delay		0	sec
	H Blocking Logic		OR	
	Cross Blocking Time		0.1	sec
	2nd Block. Enab.		Yes	
	2nd Blocking PU		15	%
	5th Block. Enab.		Yes	
	5th Blocking PU		25	%
	Harmonic Blocking Mode		Continuous	
	Inhibition Time for Harmonics		5	Sec
	Parallel Transformer		No	
	<b>Instantaneous Differential</b>			
	Inst Diff Enable		Yes	
	Inst Diff Pickup		8	pu
	Inst Diff Delay		0	Sec
	Ext Fault Block Enable		Yes	
<b>1.3</b>	<b>HV Overfluxing Protection</b>			
	Relay used (in built in differential)	=	<b>ZIV 8IDV-A4F-230GB6</b>	
	HV PT Rating-Primary kV	=	220 / $\sqrt{3}$	
	HV PT Rating-Secondary V	=	110 / $\sqrt{3}$	
	Continuous withstand capacity	=	110 %	
	<b>Characteristics (as per model setting calculation by NRPC)</b>			
	<b>Overexcitation</b>			
	<b>Unit 1</b>			
	Overex. Enable		Yes	
	Overex. Pickup		1.2	V/F
	Overex. Curve		Definite Time	
	Overex. Dial		1	
	Overex. Delay		90 S	sec
	<b>Unit 2</b>			
	Overex. Enable		Yes	
	Overex. Pickup		1.3	V/F
	Overex. Curve		Definite Time	
	Overex. Dial		1	
	Overex. Delay		50 S	sec
	<b>Unit 3</b>			
	Overex. Enable		Yes	
	Overex. Pickup		1.4	V/F
	Overex. Curve		Definite Time	
	Overex. Dial		1	
	Overex. Delay		4 S	sec
	<b>Unit 4</b>			
	Overex. Enable		Yes	
	Overex. Pickup		1.5	V/F
	Overex. Curve		Definite Time	
	Overex. Dial		1	
	Overex. Delay		1 S	sec

**Protection setting (220 kV S/Stn. Masudpur)**  
**Utility : HVPNL**

<b>220/132 kV 100 MVA TF Protection</b>				
<b>2</b>	<b>HV REF Protection for 100 MVA Transformer:</b>			<b>UNIT</b>
	Relay Used	=	<b>ZIV IRLF1BDAA0BBB1B</b>	
	Relay Nominal Value	=	1	<b>A</b>
	TF Capacity in MVA	=	100	MVA
	HV Voltage rating in kV	=	220	KV
	HV Side CT - Pri.	=	300	A
	HV Side CT - Sec.	=	1	A
	Transformer % Impedance (at normal. tap)		12.08	
<b>2.1</b>	<b>HV side Calculation for REF</b>			
	Type of Impedance	=	High Impedance	
	Rated current of the Transformer HV side (in Primary)	=	$S_{ref} / (\sqrt{3} * HV \text{ voltage})$	
		=	$100 \text{ MVA} / (\sqrt{3} * 220 \text{ kV})$ 262.4	A
	Rated current of the Transformer HV side (in Secondary)	=	262.4/300	
		=	0.874	A
	Fault MVA	=	100/0.1208	
		=	827.81	MVA
	T/F HV side Current in Amp	=	$827.81 \text{ MVA} / (\sqrt{3} * 220 \text{ kV})$	
		=	2172.43	A
	Equivalent Secondary current HV side in Amp	=	2172.43/300	
		=	<b>7.24</b>	A
	REF Pickup Current in Amp	=	10 % of full load current	
		=	0.10 x 262.4	
		=	26.2	A
	Equivalent Secondary current HV side in Amp	=	26.2/300	
		=	0.08	A
	REF pick up (To be set in relay)	=	0.10 x I <sub>n</sub>	A
	Note: This is actual current, which is required for the relay to operate, hence we consider this value for calculating the Rstab value.			
<b>2.2</b>	<b>Rstab Calculations for HV SIDE</b>			
	RCT in Ohms	=	3.8	Ohm
	Lead Length in Mtrs (assumed)	=	70	Mtr
	Resistance in ohm/ KM of the cable	=	4.5	Ohm
	Lead resistance (RL) in Ohms	=	4.5 x 70/1000	
		=	0.315	Ohm
	Voltage developed across the relay (Vs) in Volt	=	$IFL * (RCT + 2RL)$	
		=	7.24 X (3.8 + 0.63)	
		=	32.07	V
	Stabilizing Resistor value R stab in Ohms considering 150 % margin	=	Vs/Is	
		=	32.07/0.1	
		=	320.7	Ohm
		=	<b>481.05</b> ohms (to be set)	Ohm

**Protection setting (220 kV S/Stn. Masudpur)**  
**Utility : HVPNL**

<b>220/132 kV 100 MVA TF Protection</b>			
<b>3</b>	<b>Non-Directional Over Current Protection for 100 MVA Transformer:</b>		<b>UNIT</b>
	Relay Used	=	ZIV IRLF1BDAA0BBB1B
	TF Capacity in MVA	=	100 MVA
	HV Voltage rating in kV	=	220 KV
	HV Side CT - Pri.	=	300 A
	HV Side CT - Sec.	=	1 A
	Transformer % Impedance (at normal. tap)		12.08
	Rated current of the Transformer HV side (in Primary)	=	262.4 A
	Rated current of the Transformer HV side (in Secondary )	=	262.4/300 0.874 A
	Fault MVA	=	100/0.1208
		=	827.81 MVA
	Maximum through fault current in amp	=	827.81 MVA/( $\sqrt{3} * 220$ kV)
		=	2172.43 A
	Equivalent through fault current secondary in amp	=	2172.43/300
		=	7.24 A
	Time Over Current setting 51		110 % of full load Current
			262.4x 1.10
			288 A
	Equivalent Current in secondary in Amp		288/300
		Is	0.96 A
	Delay Type/IEC Curve		IEC- Normal Inverse
	Required operating time in sec t	t	0.730 s
	TMS setting adopted in relay(calculated from IDMT trip curve equation) curve  Standard inverse= k= 0.140, $\alpha=0.020$		$t(I) = TMS \left( \frac{k}{\left( \frac{I}{I_s} \right)^\alpha - 1} \right)$ <small>IEC 60255 Trip Curve Equation</small>
	TMS setting adopted in relay(calculated from IDMT trip curve equation) curve		0.22
	Direction		Non-Directional
	High set Current setting		120 % of maximum thru fault current
			1.2 x 7.4
			8.93 So done 9 A
	Time delay		0 sec
	Direction		Non-Directional
	Note: No Earth fault time current protection of HV side		

**Protection setting (220 kV S/Stn. Masudpur)**  
**Utility : HVPNL**

<b>220/132 kV 100 MVA TF Protection</b>				
<b>4</b>	<b>Non-Directional Overcurrent Protection (LV side) for 100 MVA Transformer:</b>			<b>UNIT</b>
	Relay Used	=	Alstom P14NB	
	TF Capacity in MVA	=	100	MVA
	LV Voltage rating in kV	=	132	KV
	LV Side CT - Pri.	=	500	A
	LV Side CT - Sec.	=	1	A
	Transformer % Impedance (at normal. tap)		12.08	
	Rated current of the Transformer LV side (in Primary)	=	437	
	Rated current of the Transformer LV side (in Secondary )	=	437/(500/1)	
		=	0.870	A
	Fault MVA	=	100/0.1208	
		=	827.81	MVA
	Maximum through fault current in amp	=	827.81 MVA/( $\sqrt{3}$ * 132 kV)	
		=	3620.83	A
	Equivalent through fault current secondary in amp		3620.83/(500/1)	
		I	7.24	A
	Time Over Current setting 51	=	110 % of full load Current	
		=	437 x 1.10	
			480	A
	Equivalent Current in secondary in Amp (Relay In=5 A)	=	480 /(500/1)	
			0.960	A
		I <sub>s</sub>	0.96 x I <sub>n</sub>	
	Delay Type/IEC Curve	=	IEC- Normal Inverse	
	Required operating time in sec t	t	0.600 s	sec
	TMS setting adopted in relay (calculated from IDMT trip curve equation) curve		$t(I) = TMS \left( \frac{k}{\left(\frac{I}{I_s}\right)^\alpha - 1} \right)$ <small>IEC 60255 Trip Curve Equation</small>	
	Standard inverse= k= 0.140, α=0.020			
	TMS setting adopted in relay	=	0.18	
	Direction	=	Non-Directional	
	Earth Fault protection (LV side)	=	20 % of full load Current	
		=	0.20 x I <sub>n</sub>	A
	TMS setting in relay	=	0.18	

Note: No high set protection on LV side

